

Grapple

90" Fork &
90" Bucket



Bobcat®

VersaHANDLER Attachment Service Manual

S/N 029100101 & Above
S/N 028900101 & Above

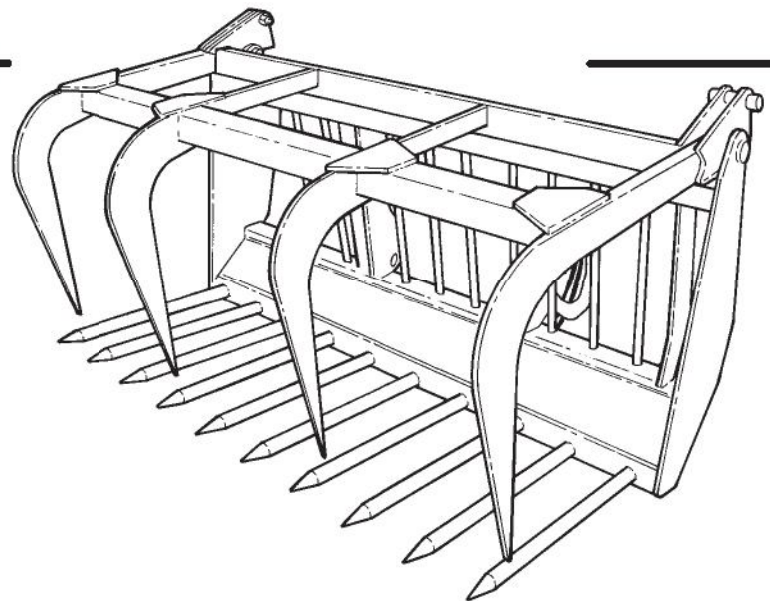

Dealer Copy - Not for Resale

Doosan purchased Bobcat Company from Ingersoll-Rand Company in 2007. Any reference to Ingersoll-Rand Company or use of trademarks, service marks, logos, or other proprietary identifying marks belonging to Ingersoll-Rand Company in this manual is historical or nominative in nature, and is not meant to suggest a current affiliation between Ingersoll-Rand Company and Bobcat Company or the products of either.



MAINTENANCE SAFETY



WARNING







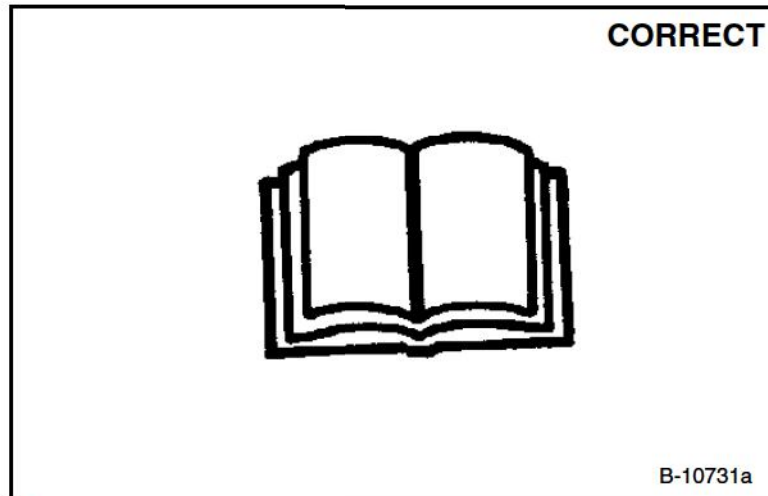

Instructions are necessary before operating or servicing machine. Read and understand the Operation & Maintenance Manual, Operator's Handbook and signs (decals) on machine. Follow warnings and instructions in the manuals when making repairs, adjustments or servicing. Check for correct function after adjustments, repairs or service. Untrained operators and failure to follow instructions can cause injury or death.

W-2003-0903



Safety Alert Symbol: This symbol with a warning statement, means: "Warning, be alert! Your safety is involved!" Carefully read the message that follows.



-  Never service attachments without instructions. See Operation & Maintenance Manual and Attachment Service Manual.
-  Cleaning and maintenance are required daily.
-  Never service or adjust attachment with the engine running unless instructed to do so in manual.
-  Always lower the attachment to the ground before lubricating or servicing.
-  Avoid contact with leaking hydraulic fluid or diesel fuel under pressure. It can penetrate skin or eyes.
-  Stop, cool and clean engine of flammable materials before checking fluids.
-  Keep body, loose objects and clothing away from moving parts, electrical contacts, hot parts and exhaust.
-  Safety glasses are needed for eye protection from electrical arcs, battery acid, compressed springs, fluids under pressure and flying debris or when tools are used. Use eye protection approved for type of welding.

ALPHABETICAL INDEX

BUCKET GRAPPLE	30-01
FORK GRAPPLE	30-01
GLOSSARY OF HYDRAULIC SYMBOLS	40-01
GRAPPLE TOOTH REMOVAL (FORK GRAPPLE)	10-01
HYDRAULIC CYLINDER	20-01
HYDRAULIC SCHEMATIC	40-01
INSPECTION	10-01
LOAD CHECK VALVE 90" BUCKET GRAPPLE .	20-01
LUBRICATION	10-01
PARTS IDENTIFICATION 90" BUCKET GRAPPLE	iv .
PARTS IDENTIFICATION 90" FORK GRAPPLE	iv .
PIVOT	30-01
SERIAL NUMBER LOCATION	iii
SPECIFICATIONS	40-01
TROUBLESHOOTING	10-01

CONTENTS

SERIAL NUMBER LOCATION	iii ..
PARTS IDENTIFICATION	iv ..
SAFETY AND MAINTENANCE	10-01
HYDRAULIC SYSTEM	20-01
MAIN FRAME	30-01
SPECIFICATIONS AND SCHEMATICS	40-01

**SAFETY AND
MAINTENANCE**

**HYDRAULIC
SYSTEM**

**MAIN
FRAME**

**SPECIFICATIONS
AND
SCHEMATICS**

**CALIFORNIA
PROPOSITION 65 WARNING**

Diesel engine exhaust and some of its constituents are known to the State of California to cause cancer, birth defects and other reproductive harm.

Dealer Copy -- Not for Resale

<https://www.ebooklibonline.com>

Hello dear friend!

Thank you very much for reading.

Enter the link into your browser.

The full manual is available for immediate download.

<https://www.ebooklibonline.com>

SERIAL NUMBER LOCATION

Always use the serial number of the machine when requesting service information or when ordering parts. Early or later models (identification made by serial number) may use different parts, or it may be necessary to use a different procedure in doing a specific service [A] or [B].

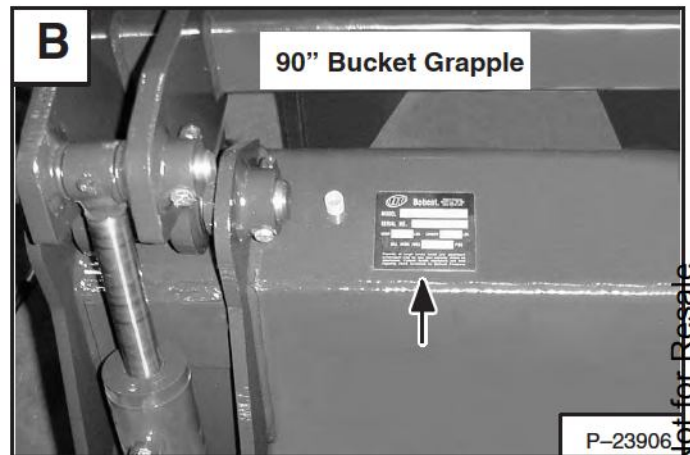
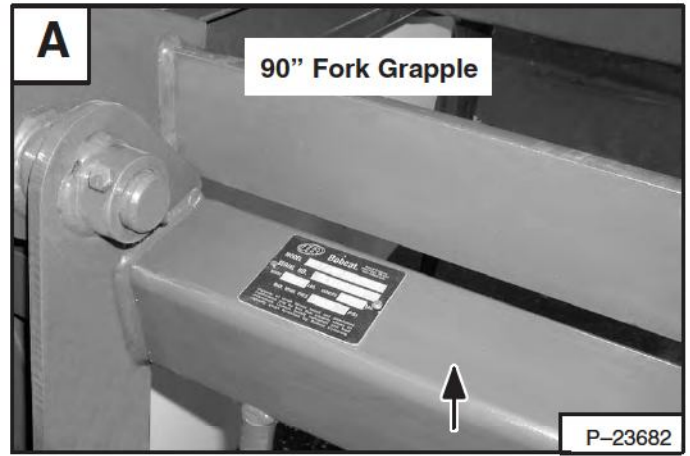

Dealer Copy -- Not for Resale

PARTS IDENTIFICATION 90" FORK GRAPPLE

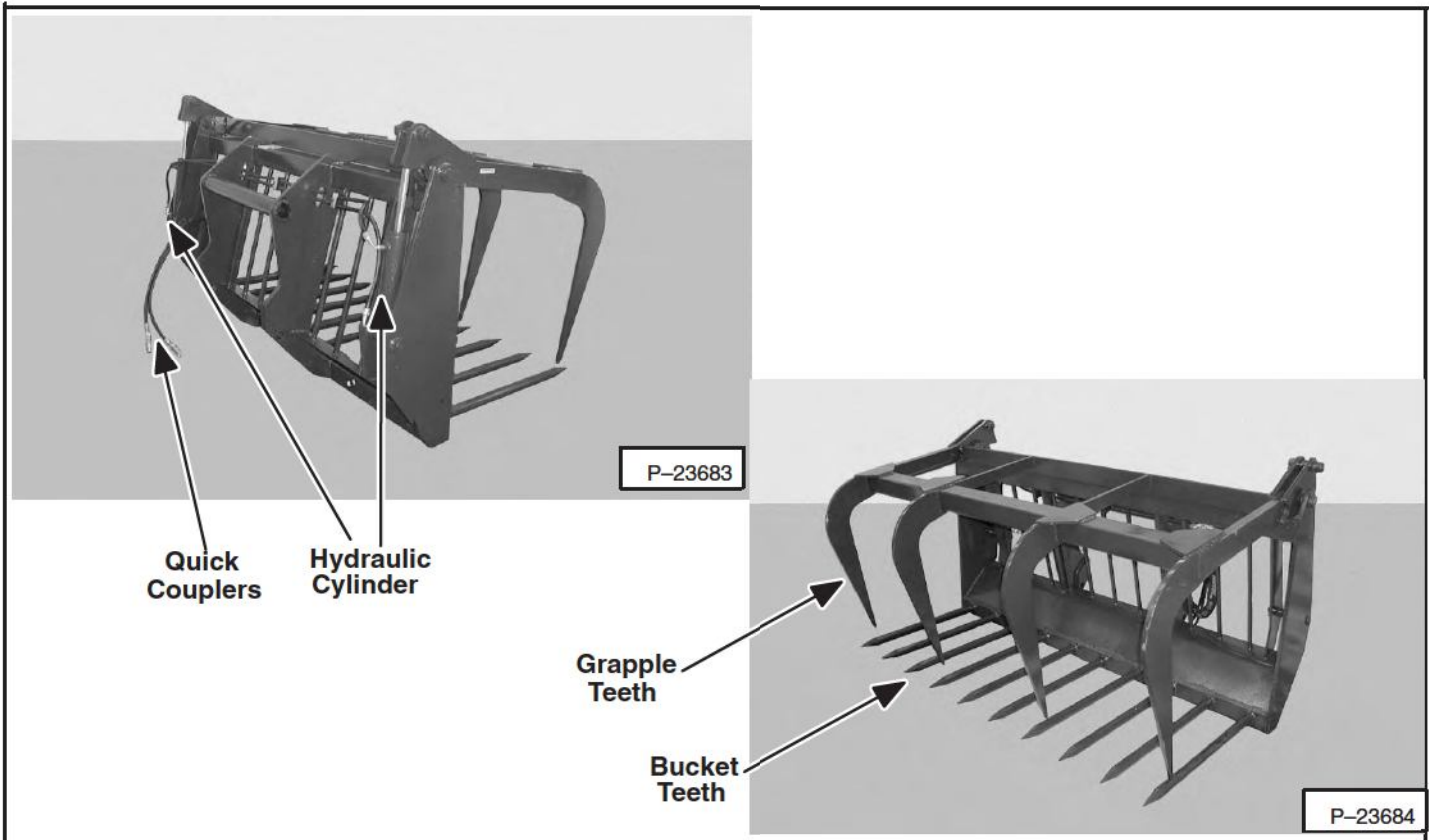

PARTS IDENTIFICATION 90" BUCKET GRAPPLE

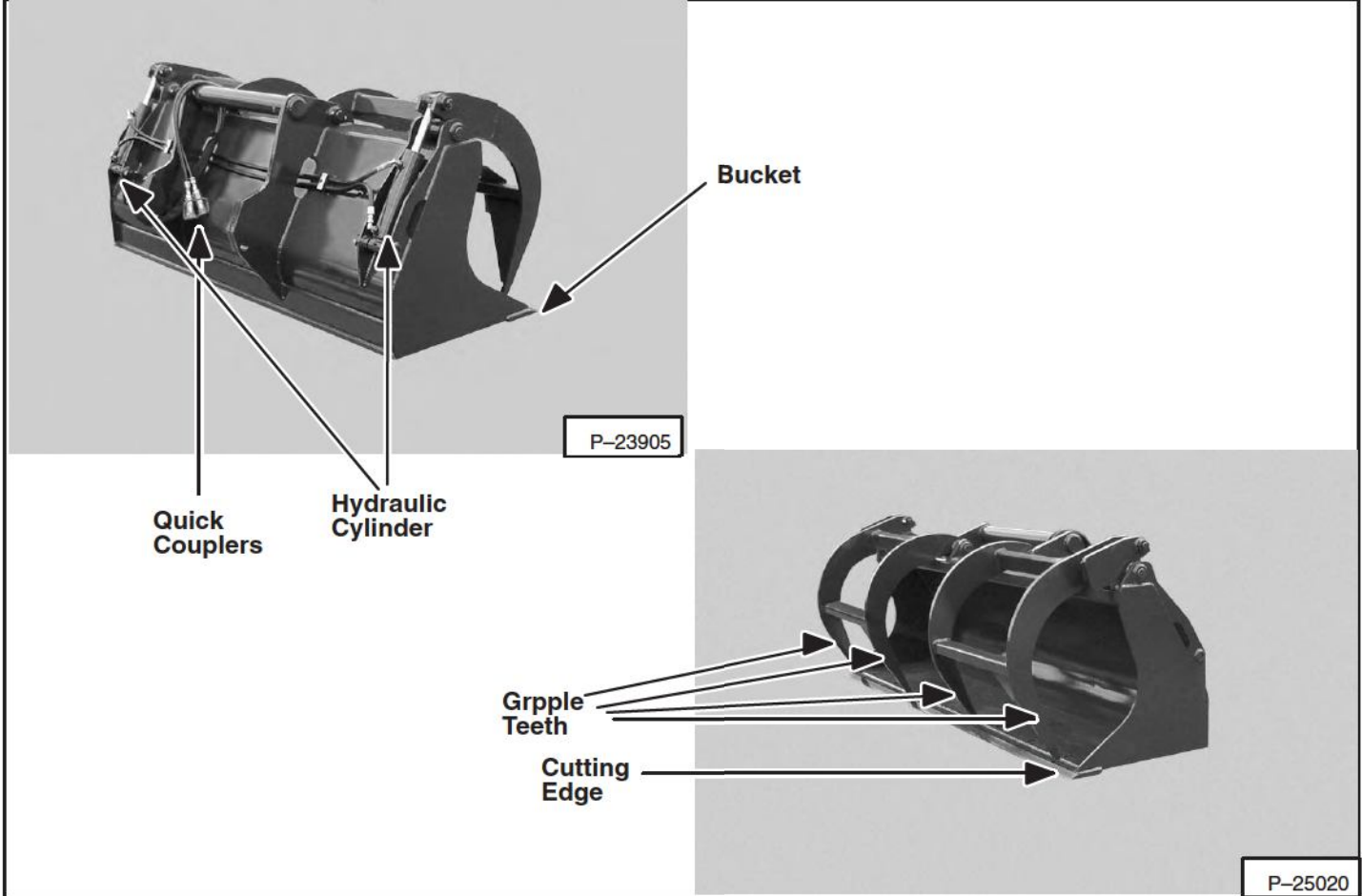

Dealer Copy -- Not for Resale

SAFETY AND MAINTENANCE

GRAPPLE TOOTH REMOVAL (FORK GRAPPLE)	10-10-4
INSPECTION	
Grapple Mount Inspection	10-10-3
VersaHANDLER Mounting Frame Inspection	10-10-2
LUBRICATION	10-10-3
TROUBLESHOOTING	10-10-1

**SAFETY AND
MAINTENANCE**

Dealer Copy -- Not for Resale

TROUBLESHOOTING



Instructions are necessary before operating or servicing machine, Read Operation & Maintenance Manual, Handbook and signs (decals) on machine. Follow warnings and instructions in the manuals when making repairs, adjustments or servicing. Check for correct function after adjustments, repairs or service. Failure to follow instructions can cause injury or death.

W-2003-0199

If the Grapple is not working correctly, check the hydraulic system of the VersaHANDLER thoroughly before making any repairs on the Grapple. Grapple problems can be affected by a hydraulic system that is not operating to specifications.

If the VersaHANDLER operation is found to be correct, use the following troubleshooting chart to locate and correct problems with the Grapple.

PROBLEM	CAUSE	CORRECTION
Grapple does not mount properly on the VersaHANDLER.	VersaHANDLER attachment locking pins are not fully retracted.	Retract VersaHANDLER attachment locking pins.
	Mud, dirt or stones are lodged between the VersaHANDLER mounting frame and the Grapple mount.	Remove debris between the VersaHANDLER mounting frame and Grapple mount.
Grapple does not open or close.	No hydraulic flow.	Activate VersaHANDLER hydraulic on/off switch.
	No hydraulic flow.	Activate VersaHANDLER secondary auxiliary hydraulic switch.
	No hydraulic flow.	Check quick couplers connection. Check for damaged hose ends and fittings.
	No hydraulic flow.	Bleed valve in the bleed position, return valve to the operating position.

Dealer Copy -- Not for Resale

INSPECTION

VersaHANDLER Mounting Frame Inspection

The VersaHANDLER mounting hooks (Item 1) [A] must not be damaged. Check for cracked or broken hooks.

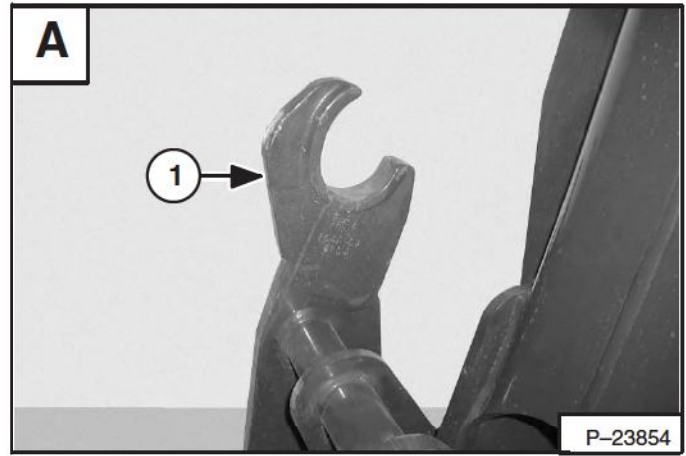

The stop blocks (Item 1) [B] must not be damaged. Check for bent or broken stop blocks.

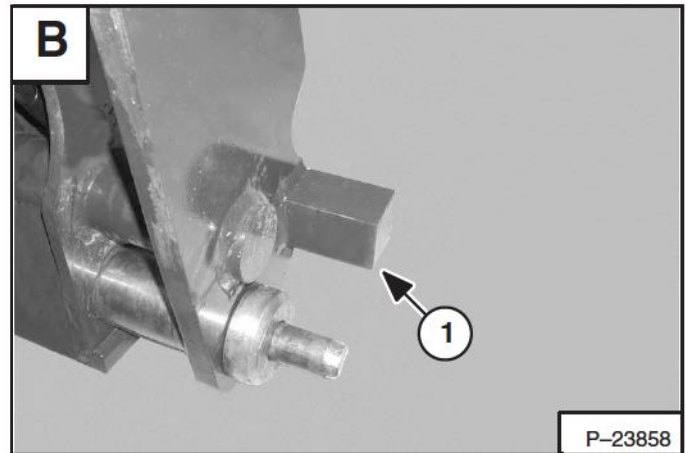

Move the VersaHANDLER locking pins to engage the pins (Item 1) [C]. The pins must move freely. The pins must not be bent or the ends mushroomed.

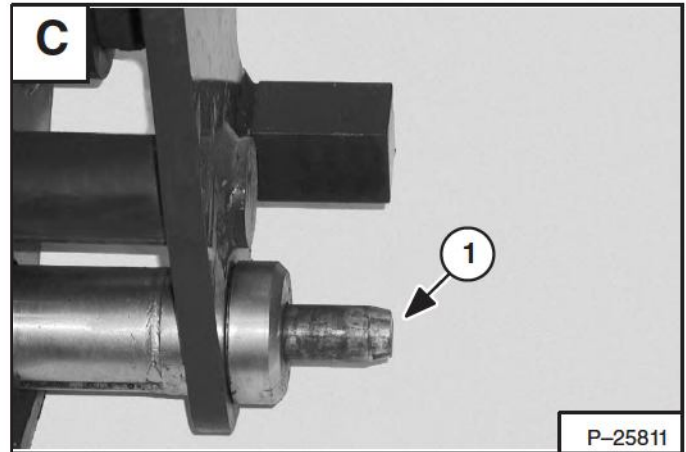

The pins must extend through the holes in the attachment mounting frame (Item 1) [D].

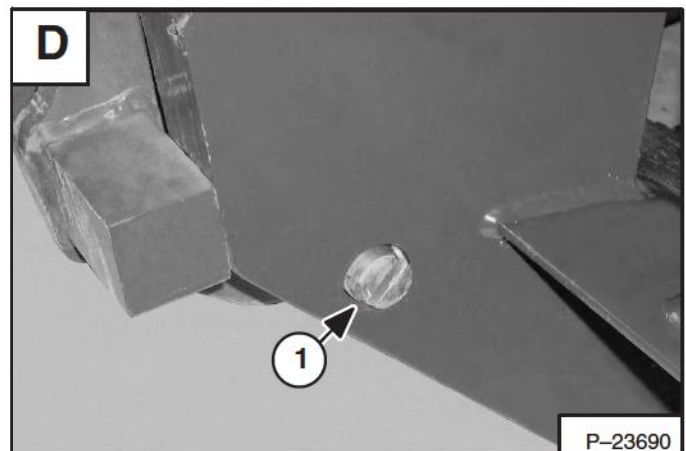

Dealer Copy -- Not for Resale

INSPECTION (Cont'd)

Grapple Mount Inspection

Inspect the grapple mounting tube (Item 1) [A] and all welds on the Grapple mount for wear and damage each time the attachment is removed from the VersaHANDLER.

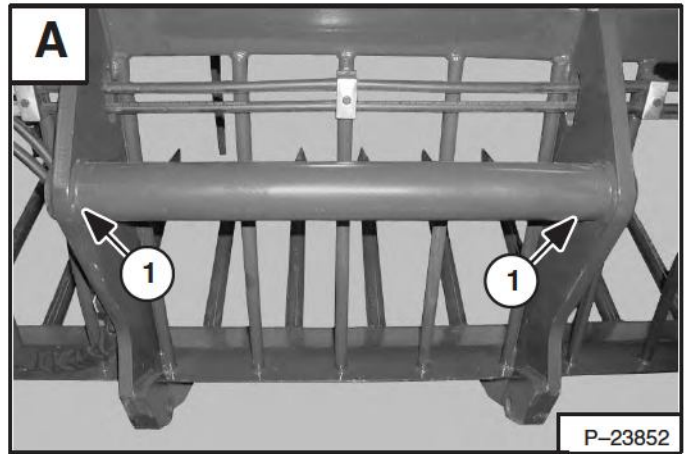

Inspect the mounting holes (Item 1) [B].

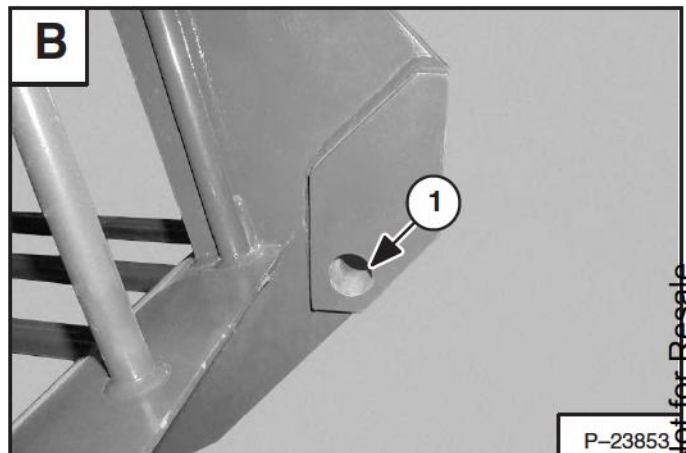

LUBRICATION

Always use a good quality lithium base multi-purpose grease when lubricating the Grapple. Apply the lubricant until extra grease shows.

IMPORTANT

Fluid such as engine oil, hydraulic fluid, coolants, grease, etc. must be disposed of in an environmentally safe manner. Some regulations require that certain spills and leaks on the ground must be cleaned in a specific manner. See local, state and federal regulations for the correct disposal.

I-2067-0499

Lubricate the six grease fittings (three per side), EVERY 8-10 hours:

Cylinder rod end (Item 1) [C].

Cylinder base end (Item 1) [D].

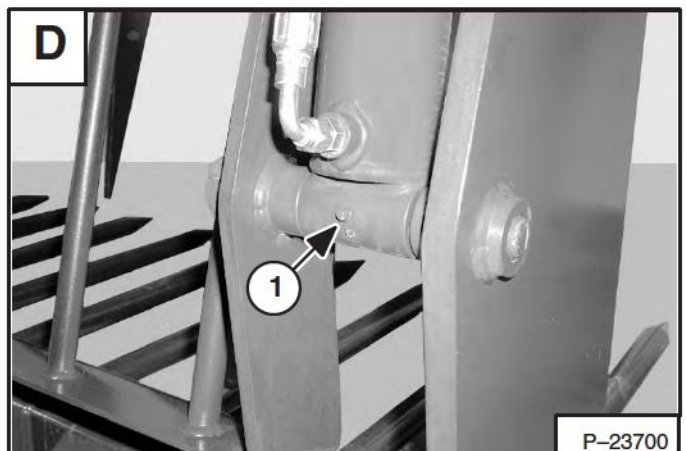
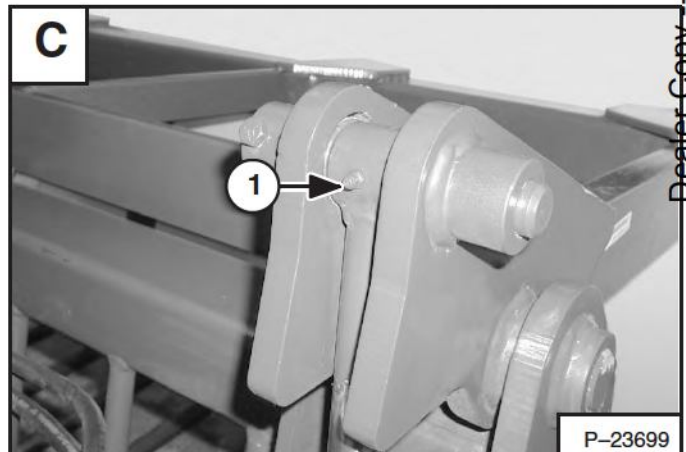

LUBRICATION (Cont'd)

Grapple pivots (Item 1) [A].

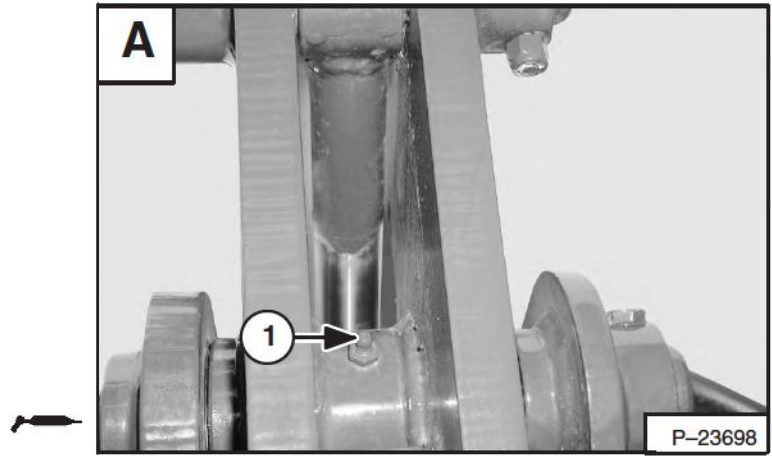

GRAPPLE TOOTH REMOVAL (FORK GRAPPLE)

Place the grapple on blocks (Item 1) [B] and remove the Grapple from the VersaHANDLER.

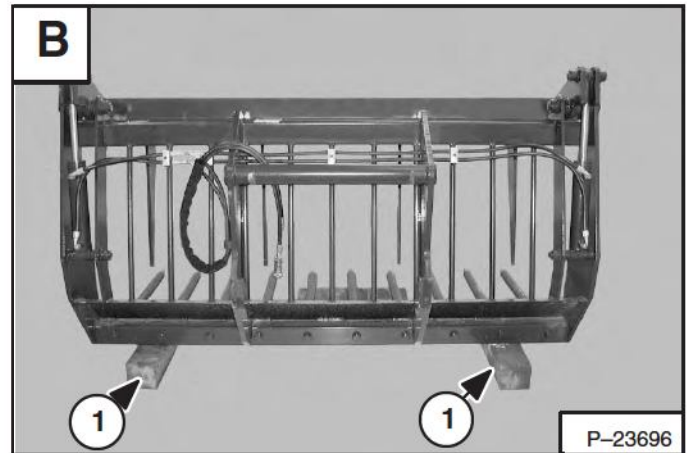

Remove the bolt (Item 1) [C] from the tooth.

Remove the tooth.

If the tooth is rusted into the socket, apply penetrating oil to the tooth at the socket.

Using a hammer and punch, drive the tooth out of the socket through the bolt hole (Item 1) [C] on the back of the frame.

Installation: Tighten the bolts to 644 ft.-lbs. (872 Nm) torque.

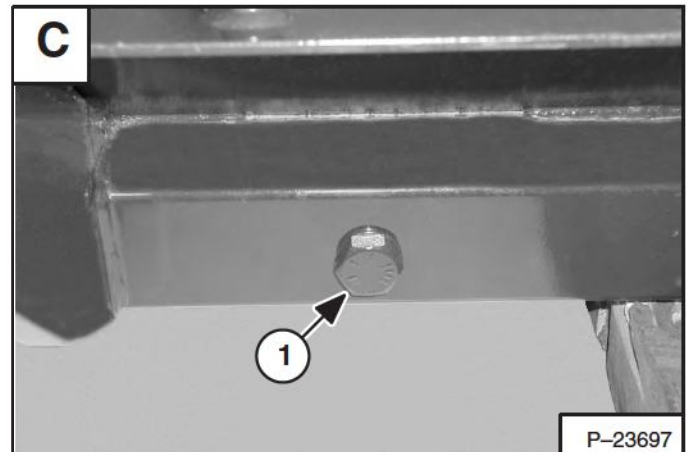

Dealer Copy -- Not for Resale

HYDRAULIC SYSTEM

PAGE NUMBER

LOAD CHECK VALVE 90" BUCKET GRAPPLE

Disassembly And Assembly	20-20-2
Removal And Installation	20-20-1

HYDRAULIC CYLINDER

Assembly	20-10-8
Checking	20-10-1
Disassembly	20-10-4
Parts Identification	20-10-3
Removal And Installation	20-10-2

**HYDRAULIC
SYSTEM**

Dealer Copy -- Not for Resale

HYDRAULIC CYLINDER

Checking

Lower the grapple to the work surface.

Stop the VersaHANDLER engine, engage the parking brake, unfasten the seat belt and exit the VersaHANDLER.

Remove the bolts and lock nuts (Item 1) [A] from the rod end cylinder pins on both cylinders.

Installation: Tighten the bolts to 25–28 ft.-lbs. (34–38 Nm) torque.

Remove the pins (Item 2) [A] from both cylinders.

Enter the VersaHANDLER, fasten the seat belt, and start the engine.

Retract the cylinders (Item 1) [B].

Stop the VersaHANDLER engine, unfasten the seat belt and exit the VersaHANDLER.

Release the auxiliary hydraulic pressure.

IMPORTANT

Fluid such as engine oil, hydraulic fluid, coolants, grease, etc. must be disposed of in an environmentally safe manner. Some regulations require that certain spills and leaks on the ground must be cleaned in a specific manner. See local, state and federal regulations for the correct disposal.

I-2067-0499

Remove the base end cylinder hose (Item 1)[B] from both cylinders.

Enter the VersaHANDLER, fasten the seat belt and start the engine.

Retract the hydraulic cylinders.

If there is any leakage from the base end of either cylinder remove the cylinder for repair or replacement.

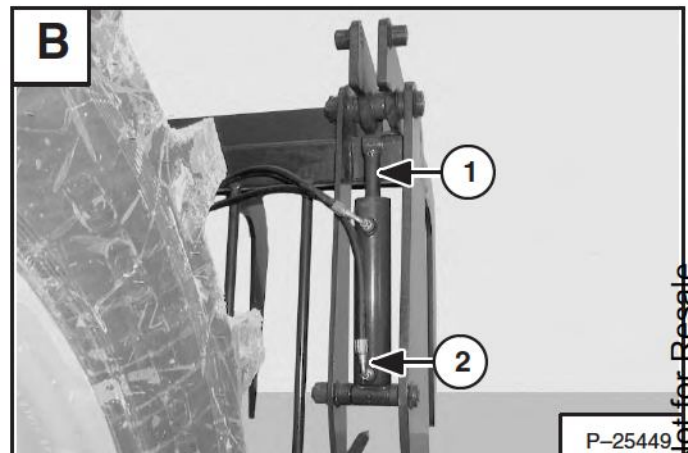
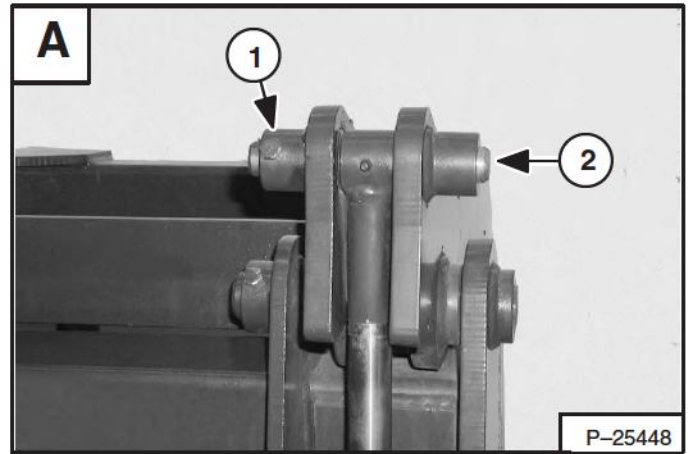

Dealer Copy -- Not for Resale



Suggest:

If the above button click is invalid.

Please download this document first, and then click the above link to download the complete manual.

Thank you so much for reading

HYDRAULIC CYLINDER (CONT'D)

Removal And Installation

! WARNING

Hydraulic fluid escaping under pressure can have sufficient force to enter a person's body by penetrating the skin. This can cause serious injury and possibly death if proper medical treatment by a physician familiar with this injury is not received immediately.

W-2145-0290

IMPORTANT

When making repairs on hydraulic system, clean the work area before disassemble and keep all parts clean. Always use caps and plugs on hoses, tubelines and ports to keep dirt out. Dirt can quickly damage the system.

I-2056-0793

Mark the hoses for correct installation.

Remove the hoses (Item 1) [A].

Install caps and plugs.

Remove the bolt and lock nut (Item 1)[B] from the base end cylinder pin (Item 2) [B] and remove the pin.

Installation: Tighten the bolt to 25–28 ft.-lbs. (34–38 Nm) torque.

Remove the bolt and lock nut (Item 1)[C] from the rod end cylinder pin (Item 2) [C].

Installation: Tighten the bolt to 25–28 ft.-lbs. (34–38 Nm) torque.

Remove the pin (Item 2) [C].

Remove the cylinder.

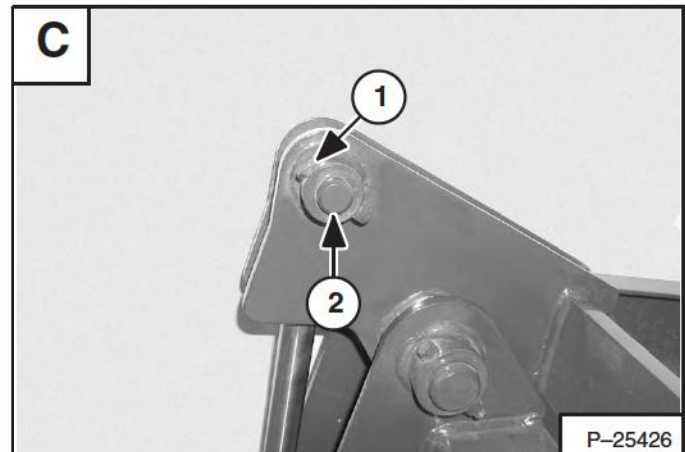
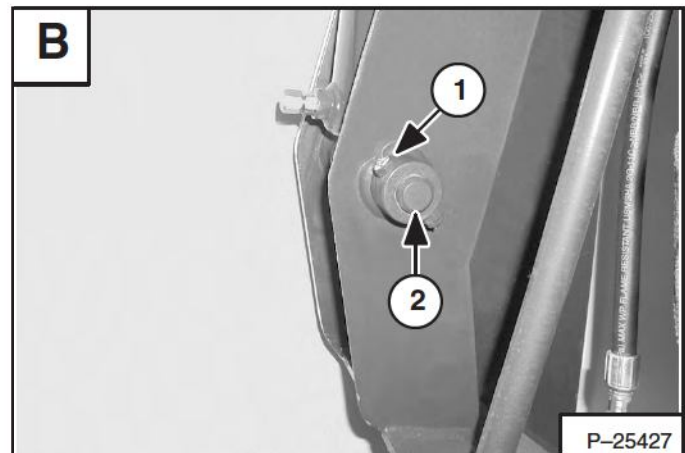
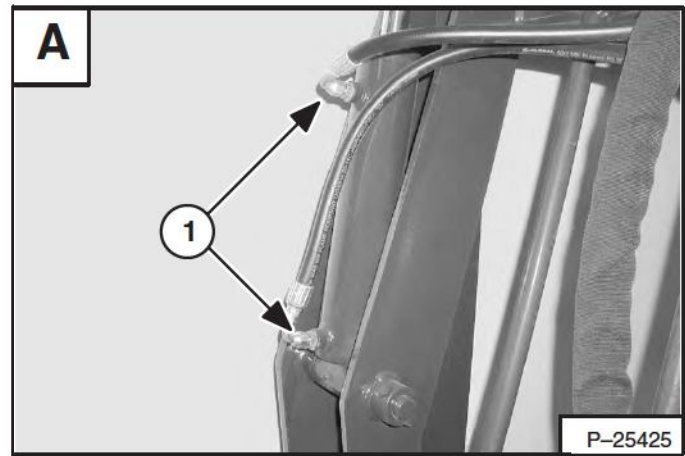

Dealer Copy -- Not for Resale

<https://www.ebooklibonline.com>

Hello dear friend!

Thank you very much for reading.

Enter the link into your browser.

The full manual is available for immediate download.

<https://www.ebooklibonline.com>