

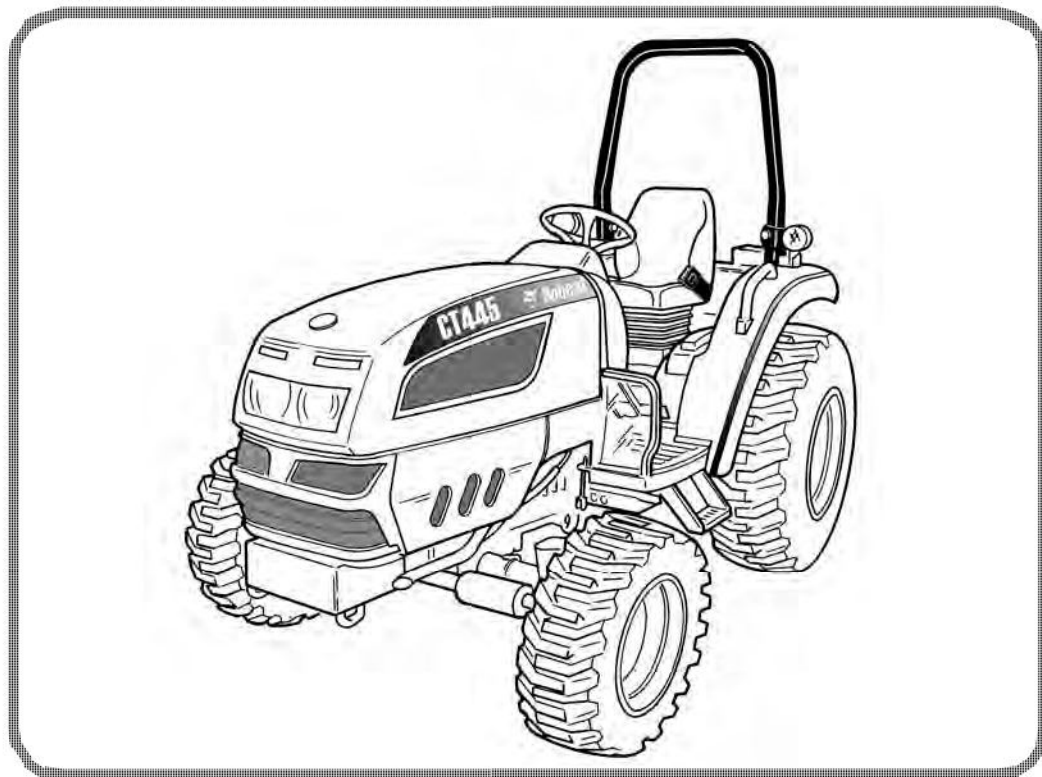

Bobcat®

Service Manual CT440, CT445, CT450 Compact Tractor

HST - S/N ABHE11001 & Above
HST - S/N ABHL11001 & Above
HST - S/N ABHM11001 & Above
SST - S/N AKB911001 & Above
SST - S/N AKBP11001 & Above



Dealer Copy -- Not for Resale



MAINTENANCE SAFETY



WARNING

Instructions are necessary before operating or servicing machine. Read and understand the Operation & Maintenance Manual, Operator's Handbook and signs (decals) on machine. Follow warnings and instructions in the manuals when making repairs, adjustments or servicing. Check for correct function after adjustments, repairs or service. Untrained operators and failure to follow instructions can cause injury or death. W-2003-0807



Safety Alert Symbol: This symbol with a warning statement, means: "Warning, be alert! Your safety is involved!" Carefully read the message that follows.

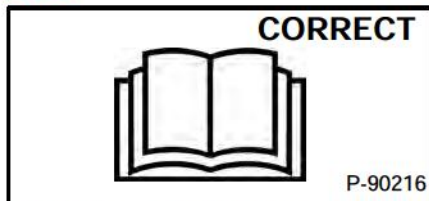

P-90216

⚠ Never service the machine without instructions.

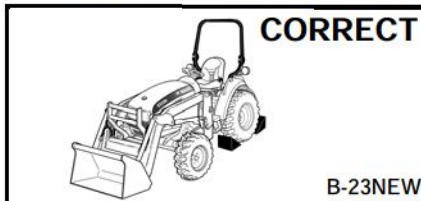

B-23NEW

⚠ Before exiting machine, engage parking brake. Chock wheels before servicing

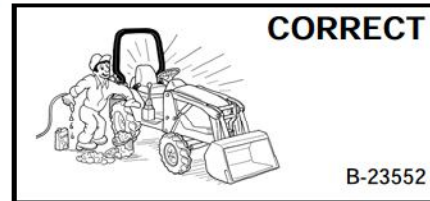

B-23552

⚠ Cleaning and maintenance are required daily.

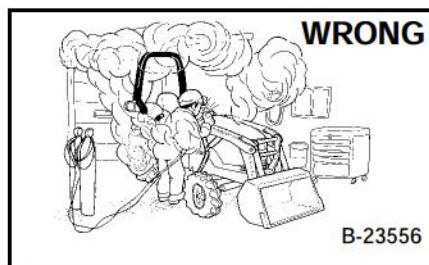

B-23556

⚠ Have good ventilation when welding or grinding painted parts.
 ⚠ Wear dust mask when grinding painted parts. Toxic dust and gas can be produced.
 ⚠ Avoid exhaust fume leaks which can kill without warning. Exhaust system must be tightly sealed.

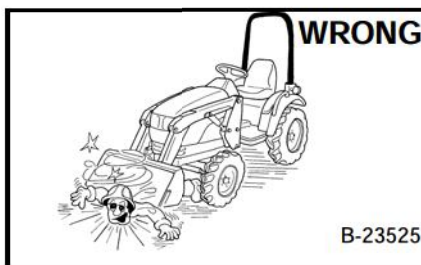

B-23525

⚠ Disconnecting or loosening any hydraulic tubeline, hose, fitting, component or a part failure can cause loader arms to drop.
 ⚠ Lower loader arms, attachments, and implements (if equipped) before servicing.
 ⚠ DO NOT service the compact tractor or implement with the PTO system engaged.

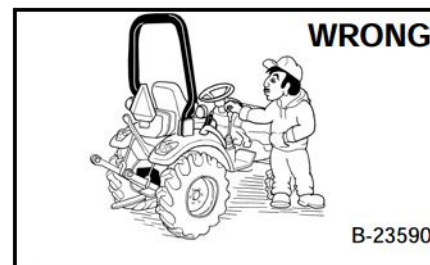

B-23590

⚠ Never start the machine if not properly seated in the operator's seat.
 ⚠ Never work on the machine with loader arms raised.
 ⚠ Never modify equipment or add attachments not approved by Bobcat Company.

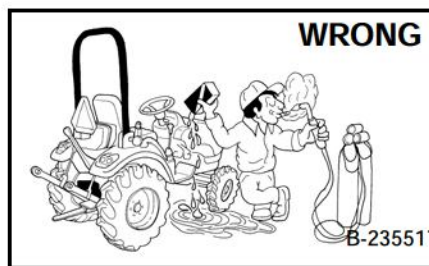

B-23551

⚠ Stop, cool and clean engine of flammable materials before checking fluids.
 ⚠ Never service or adjust machine with the engine running unless instructed to do so in the manual.
 ⚠ Avoid contact with leaking hydraulic fluid or diesel fuel under pressure. It can penetrate the skin or eyes.
 ⚠ Never fill fuel tank with engine running, while smoking or when near open flame.

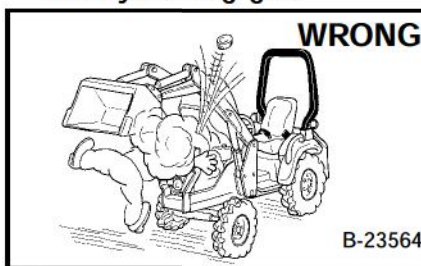

B-23564

⚠ Keep body, jewelry and clothing away from moving parts, electrical contact, hot parts and exhaust.
 ⚠ Wear eye protection to guard from battery acid, compressed springs, fluids under pressure and flying debris when engines are running or tools are used. Use eye protection approved for type of welding.
 ⚠ Keep engine cover and side access panels closed except for service.



B-6589

⚠ Lead-acid batteries produce flammable and explosive gases.
 ⚠ Keep arcs, sparks, flames and lighted tobacco away from batteries.
 ⚠ Batteries contain acid which burns eyes or skin on contact. Wear protective clothing. If acid contacts body, flush well with water. For eye contact, flush well and get immediate medical attention.

Maintenance procedures which are given in the Operation & Maintenance Manual can be performed by the owner/operator without any specific technical training. Maintenance procedures which are **not** in the Operation & Maintenance Manual must be performed **ONLY BY QUALIFIED BOBCAT SERVICE PERSONNEL**. Always use genuine Bobcat replacement parts.

MSW32-0409

Dealer Copy -- Not for Resale

CONTENTS

SAFETY & MAINTENANCE	10-01
HYDRAULIC SYSTEM	20-01
HYDROSTATIC SYSTEM	30-01
DRIVE SYSTEM	40-01
MAINFRAME	50-01
ELECTRICAL SYSTEM & ANALYSIS	60-01
ENGINE SERVICE	70-01
HEATING, VENTILATION, AIR CONDITIONING	80-01
SPECIFICATIONS	SPEC-01
ALPHABETICAL INDEX	INDEX-01

Dealer Copy -- Not for Resale

FOREWORD

FOREWORD	1-7
SAFETY INSTRUCTIONS	1-9
Use Safety Rules	1-10
Safety Rules For Power Take-Off (PTO) Driven Implements	1-11
Compact Tractor Requirements and Capabilities	1-11
FIRE PREVENTION	1-12
Maintenance	1-12
Operation	1-12
Electrical	1-12
Hydraulic System	1-12
Fueling	1-12
Starting	1-12
Spark Arrester Exhaust System	1-12
Welding And Grinding	1-13
Fire Extinguishers	1-13
SERIAL NUMBER LOCATIONS	1-14
Compact Tractor Serial Number	1-14
Engine Serial Number	1-14
Loader Serial Number (Optional)	1-14
DELIVERY REPORT	1-16
COMPACT TRACTOR IDENTIFICATION	1-17
COMPACT TRACTOR IDENTIFICATION (WITH OPTIONAL LOADER AND REAR BALLAST)	1-18
COMPACT TRACTOR IDENTIFICATION (WITH OPTIONAL THREE-POINT IMPLEMENT AND FRONT BALLAST)	1-19
COMPACT TRACTOR IDENTIFICATION (WITH OPTIONAL CAB)	1-20

Dealer Copy -- Not for Resale

<https://www.ebooklibonline.com>

Hello dear friend!

Thank you very much for reading.

Enter the link into your browser.

The full manual is available for immediate download.

<https://www.ebooklibonline.com>

FOREWORD

This manual is for the Bobcat compact tractor mechanic. It provides necessary servicing and adjustment procedures for the Bobcat compact tractor and its component parts and systems. Refer to the Operation & Maintenance Manual for operating instructions, starting procedure, daily checks, etc.

A general inspection of the following items must be made after the compact tractor has had service or repair:

1. Check that the ROPS is in good condition and is not modified.



2. Check that ROPS mounting hardware is tightened and is Bobcat approved.



3. The seat belt must be correctly installed, functional and in good condition.



4. Machine signs (decals) must be legible and in the correct location.



5. Travel control pedal(s) and loader joystick control lever must return to neutral.



6. Check for correct function of the work lights.



7. The parking brake must function correctly.

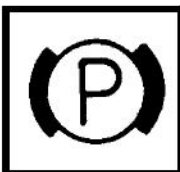

8. Enclosure door latches must open and close freely.



9. Attachment locking pins must function correctly and be in good condition. Bob-Tach wedges and linkages (if equipped) must function correctly and be in good condition.



10. Safety treads must be in good condition.



11. Check for correct function of indicator lamps.

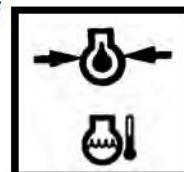

12. Check hydraulic fluid level, engine oil level and fuel supply.



13. Inspect for fuel, oil or hydraulic fluid leaks.

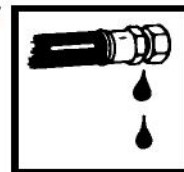

14. Lubricate the compact tractor.



Dealer Copy -- Not for Resale

15. Check the condition of the battery and cables.

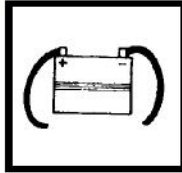

20. Check for any field modification not completed.



16. Inspect the air cleaner for damage or leaks. Check the condition of the element.

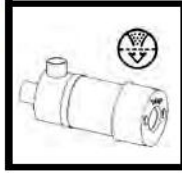

21. Operate the machine and check all functions.

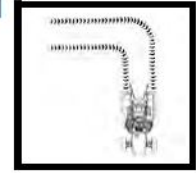

17. Check the electrical charging system.

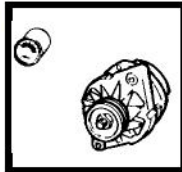

22. Check Safety Interlock System (Neutral Start and Operating) for correct function before the machine is returned to the customer.



18. Check tires for wear and pressure. Use only approved tires.

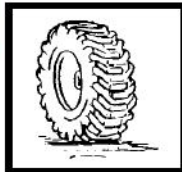

23. Check function or condition of all equipped options and accessories (examples: back-up alarm, front-end loader, etc.).



19. Inspect for loose or broken parts or connections.

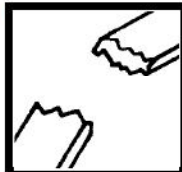

24. Recommend to the owner that all necessary corrections be made before the machine is returned to service.



**CALIFORNIA
PROPOSITION 65 WARNING**

Diesel engine exhaust and some of its constituents are known to the state of California to cause cancer, birth defects and other reproductive harm.

SAFETY INSTRUCTIONS

 Safety Alert Symbol
This symbol with a warning statement means: "Warning, be alert! Your safety is involved!" Carefully read the message that follows.



AVOID INJURY OR DEATH

Instructions are necessary before operating or servicing machine. Read and understand the Operation & Maintenance Manual, Operator's Handbook and signs (decals) on machine. Follow warnings and instructions in the manuals when making repairs, adjustments or servicing. Check for correct function after adjustments, repairs or service. Untrained operators and failure to follow instructions can cause injury or death.

W-2003-0807



This notice identifies procedures which must be followed to avoid damage to the machine.

I-2019-0284



The signal word DANGER on the machine and in the manuals indicates a hazardous situation which, if not avoided, will result in death or serious injury.

D-1002-1107



The signal word WARNING on the machine and in the manuals indicates a potentially hazardous situation which, if not avoided, could result in death or serious injury.

W-2044-1107

The following publications provide information on the safe use and maintenance of the Bobcat compact tractor and attachments / implements:

- The Delivery Report is used to assure that complete instructions have been given to the new owner and that the machine is in safe operating condition.
- The Operation & Maintenance Manual delivered with the machine or attachment / implement contains operating information as well as routine maintenance and service procedures. It is a part of the machine and can be stored in a container provided on the machine. Replacement Operation & Maintenance Manuals can be ordered from your Bobcat dealer.
- Machine signs (decals) instruct on the safe operation and care of your Bobcat machine or attachment / implement. The signs and their locations are shown in the Operation & Maintenance Manual. Replacement signs are available from your Bobcat dealer.
- An Operator's Handbook fastened below the instrument panel. It's brief instructions are convenient to the operator. The handbook is available from your dealer in an English edition or one of many other languages. See your Bobcat dealer for more information on translated versions.
- The AEM Safety Manual delivered with the machine gives general safety information.
- The Service Manual and Parts Manual are available from your dealer for use by mechanics to do shop-type service and repair work.

Dealer Copy -- Not for Resale

SI CT-0913 SM

SAFETY INSTRUCTIONS (CONT'D)

Safety Rules For Power Take-Off (PTO) Driven Implements

- Keep PTO shields and all guards in place. Replace damaged or missing shields and guards before operating.
- Follow warnings and instructions on machine signs (decals). Replace damaged or missing decals.
- Do not wear loose or bulky clothing around the PTO or other moving parts.
- Keep bystanders away from PTO driven equipment, and never allow children near machines.
- Read and understand the manuals for the PTO driven equipment and be aware of safe operating procedures and hazards that may not be readily apparent.
- Always walk around equipment to avoid coming near a turning PTO driveline. Stepping over, leaning across or crawling under a turning PTO driveline can cause entanglement.
- Position the machine and implement hitch correctly to prevent driveline stress and separation.
- Use caution when turning. Turning too sharp can cause driveline damage.
- Use caution when raising PTO driven implement. Excessive driveline angle can cause driveline damage. Use stops if needed.

Compact Tractor Requirements and Capabilities

- Fasten seat belt securely when Roll-Over Protective Structure (ROPS) is up and locked. DO NOT wear seat belt if ROPS is down.
- Compact tractor must be equipped with sway bars or chains.
- Stop the compact tractor and engage the parking brakes. Install blocks in front of and behind the rear tires of the compact tractor. Install blocks underneath and support the implement securely before working under raised implements.
- Keep bystanders clear of moving parts and the work area. Keep children away.
- Use increased caution on slopes and near banks and ditches to prevent overturn.

- Make certain that the Slow Moving Vehicle (SMV) emblem is installed so that it is visible and legible. When transporting the equipment, use the compact tractor flashing warning lights and follow all local regulations.
- Operate this equipment with a compact tractor equipped with an approved Roll-Over Protective Structure (ROPS). Always wear seat belt when the ROPS is up. Serious injury or death could result from falling off the compact tractor.
- Before leaving the compact tractor operator's seat:
 1. Park on flat level ground.
 2. Fully lower the loader arms and put the attachment flat on the ground (if equipped).
 3. Fully lower the three-point hitch or mid-mount implements (if equipped).
 4. Lock brake pedals together and engage the parking brake.
 5. Place all controls in neutral.
 6. Stop engine, unfasten seat belt and remove the key.
- Never allow riders on the compact tractor or implement. Falling off can result in serious injury or death.
- Start the compact tractor only when properly seated in the operator's seat. Starting a compact tractor in gear can result in serious injury or death.
- Operate the compact tractor and attachments / implements from the operator's position only.
- Add the correct front ballast for rear three-point hitch implements and pull type implements. Add the correct rear ballast when using the loader and attachments. Front and rear ballast can be purchased from your compact tractor dealer.
- Do not handle large objects (such as round bales or posts) unless the loader is equipped with the proper attachment and the load is secured.
- The parking brake must be engaged before leaving the compact tractor operator's seat. Rollaway can occur because the transmission may not prevent machine movement. Lock the brake pedals together before activating the parking brake.

Dealer Copy -- Not for Resale

SI CT-0913 SM

FIRE PREVENTION



Maintenance

The machine and some attachments / implements have components that are at high temperatures under normal operating conditions. The primary source of high temperatures is the engine and exhaust system. The electrical system, if damaged or incorrectly maintained, can be a source of arcs or sparks.

Flammable debris (leaves, straw, etc.) must be removed regularly. If flammable debris is allowed to accumulate, it can cause a fire hazard. Clean often to avoid this accumulation. Flammable debris in the engine compartment is a potential fire hazard.

The operator's area, engine compartment and engine cooling system must be inspected every day and cleaned if necessary to prevent fire hazards and overheating.

All fuels, most lubricants and some coolants mixtures are flammable. Flammable fluids that are leaking or spilled onto hot surfaces or onto electrical components can cause a fire.

Operation

Do not use the machine where exhaust, arcs, sparks or hot components can contact flammable material, explosive dust or gases.

Electrical



Check all electrical wiring and connections for damage. Keep the battery terminals clean and tight. Repair or replace any damaged part or wires that are loose or frayed.

Battery gas can explode and cause serious injury. Use the procedure in the Operation & Maintenance Manual for connecting the battery and for jump starting. Do not jump start or charge a frozen or damaged battery. Keep any open flames or sparks away from batteries. Do not smoke in battery charging area.

Hydraulic System

Check hydraulic tubes, hoses and fittings for damage and leakage. Never use open flame or bare skin to check for leaks. Hydraulic tubes and hoses must be properly routed and have adequate support and secure clamps. Tighten or replace any parts that show leakage.

Always clean fluid spills. Do not use gasoline or diesel fuel for cleaning parts. Use commercial nonflammable solvents.

Fueling



Stop the engine and let it cool before adding fuel. No smoking! Do not refuel a machine near open flames or sparks. Fill the fuel tank outdoors.

Ultra Low Sulfur Diesel (ULSD) poses a greater static ignition hazard than earlier diesel formulations with higher Sulfur content. Avoid death or serious injury from fire or explosion. Consult with your fuel or fuel system supplier to ensure the delivery system is in compliance with fueling standards for proper grounding and bonding practices.

Starting

Do not use ether or starting fluids on any engine that has glow plugs. These starting aids can cause explosion and injure you or bystanders.

Use the procedure in the Operation & Maintenance Manual for connecting the battery and for jump starting.

Spark Arrester Exhaust System

The spark arrester exhaust system is designed to control the emission of hot particles from the engine and exhaust system, but the muffler and the exhaust gases are still hot.

Check the spark arrester exhaust system regularly to make sure it is maintained and working properly. Use the procedure in the Operation & Maintenance Manual for cleaning the spark arrester muffler (if equipped).

SI CT-0913 SM

FIRE PREVENTION (CONT'D)

Welding And Grinding

Always clean the machine and attachment / implement, disconnect the battery, and disconnect the wiring from the Bobcat controllers before welding. Cover rubber hoses, battery and all other flammable parts. Keep a fire extinguisher near the machine when welding.

Have good ventilation when grinding or welding painted parts. Wear dust mask when grinding painted parts. Toxic dust or gas can be produced.

Dust generated from repairing nonmetallic parts such as hoods, fenders or covers can be flammable or explosive. Repair such components in a well ventilated area away from open flames or sparks.

Fire Extinguishers

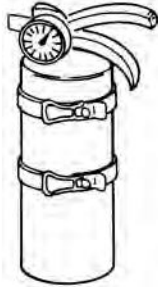

Know where fire extinguishers and first aid kits are located and how to use them. Inspect the fire extinguisher and service the fire extinguisher regularly. Obey the recommendations on the instructions plate.

SERIAL NUMBER LOCATIONS

Always use the serial number of the compact tractor when requesting service information or when ordering parts. Early or later models (identification made by serial number) may use different parts, or it may be necessary to use a different procedure in doing a specific service operation.

Figure 1

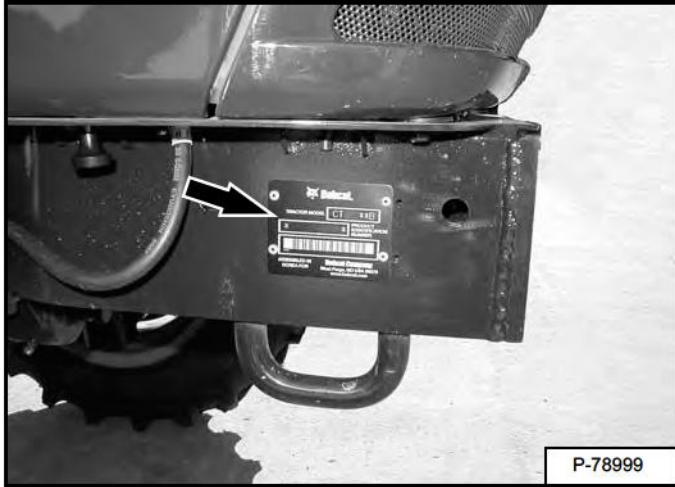

Compact Tractor Serial Number

The compact tractor serial number plate is located on the left front corner of the frame [Figure 1].

Explanation of machine Serial Number:

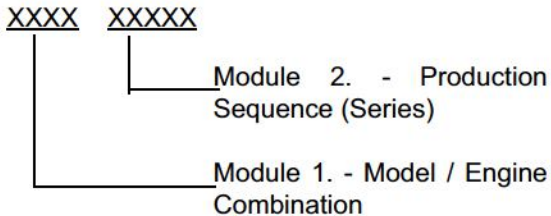

1. The four digit Model / Engine Combination Module number identifies the model number and engine combination.

2. The five digit Production Sequence Number identifies the order which the compact tractor is produced.

Engine Serial Number

Figure 2

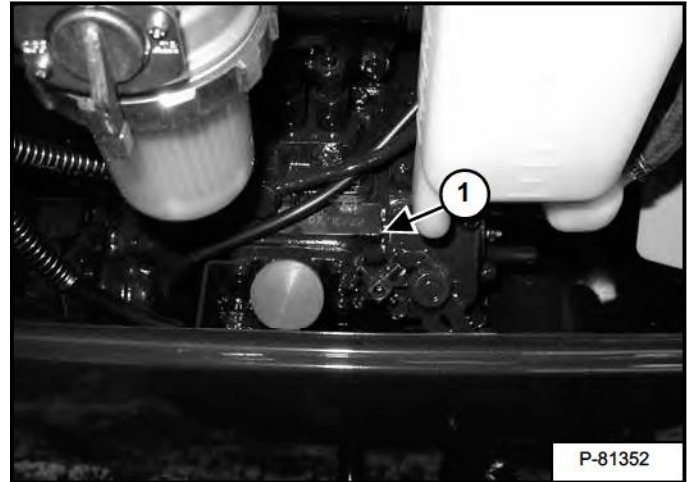

The engine serial number is located on the top of the injection pump (Item 1) [Figure 2].

Loader Serial Number (Optional)

Figure 3



The loader serial number is located on the left loader arm (Item 1) [Figure 3] (early models).

SERIAL NUMBER LOCATIONS (CONT'D)

Loader Serial Number (Optional) (Cont'd)

Figure 4

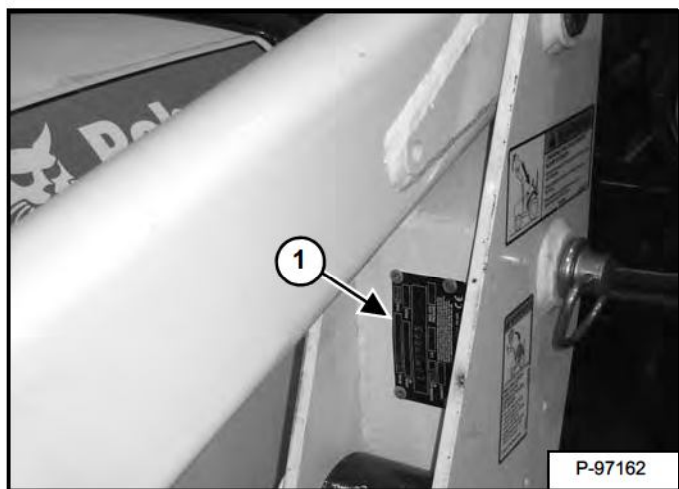

The loader serial number is located on the loader upright (Item 1) [Figure 4] (later models).

DELIVERY REPORT

Figure 5

The diagram shows a form titled "DELIVERY REPORT". The form is divided into several sections. At the top right, the title "DELIVERY REPORT" is printed. Below the title, there are several horizontal lines for text entry. On the left side, there is a section with a dark header containing the word "WARNING" in white capital letters. Below this header are several horizontal lines. To the right of the "WARNING" section, there are more horizontal lines. At the bottom right of the form, there is a small rectangular box containing the alphanumeric code "B-16315".

The delivery report must be filled out by the dealer and signed by the owner or operator when the compact tractor is delivered. An explanation of the form must be given to the owner. Make sure it is filled out completely [Figure 5].

COMPACT TRACTOR IDENTIFICATION

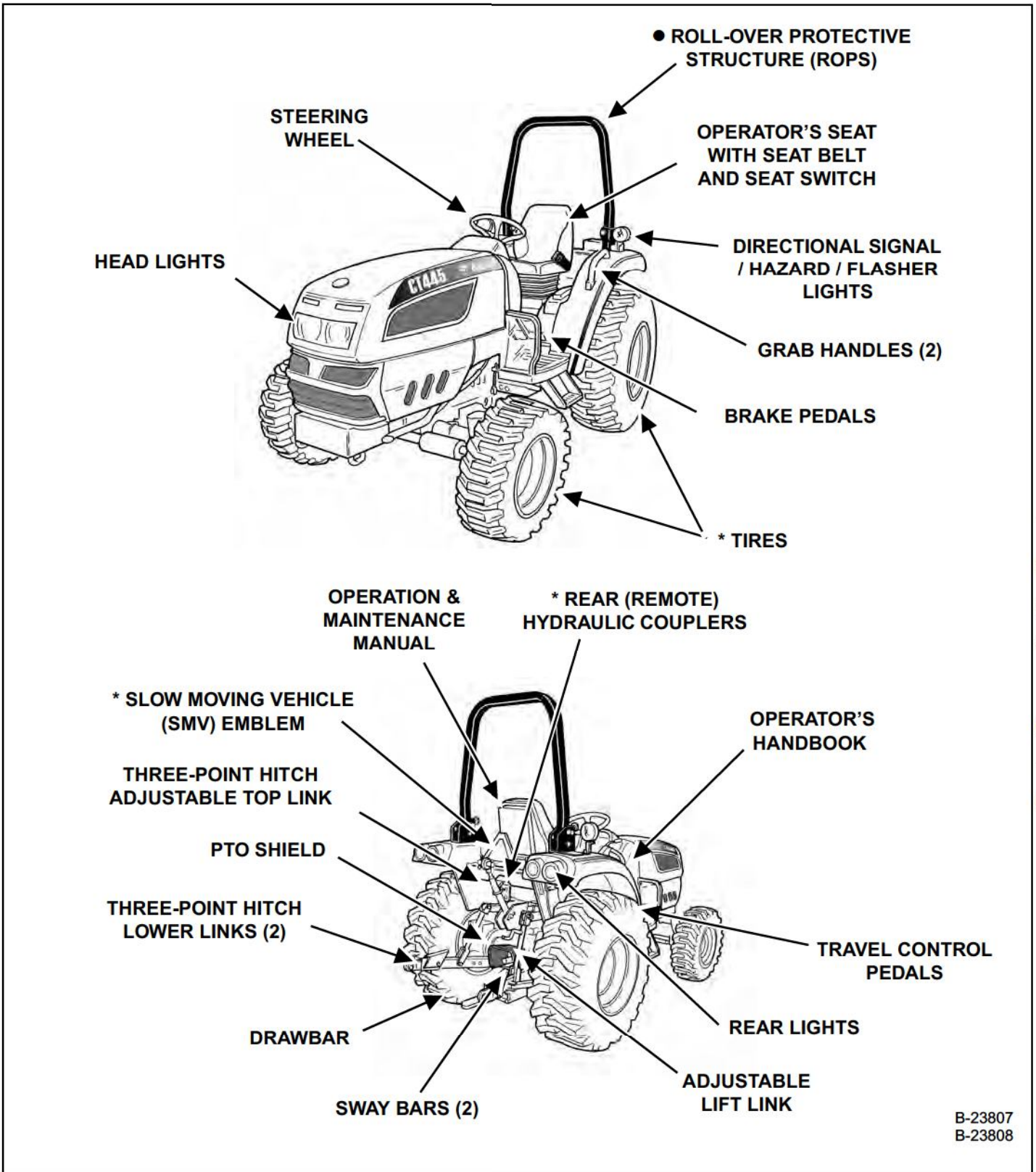

Dealer Copy -- Not for Resale

B-23807
B-23808

- † ATTACHMENTS AND IMPLEMENTS - Attachments and implements are available for the compact tractor.
- ROPS - Roll-Over Protective Structure, per ASABE S478 and OSHA 29 CFR PART 1928 Subpart C.
- * OPTIONAL OR FIELD ACCESSORIES (Not Standard Equipment).

COMPACT TRACTOR IDENTIFICATION (WITH OPTIONAL LOADER AND REAR BALLAST)

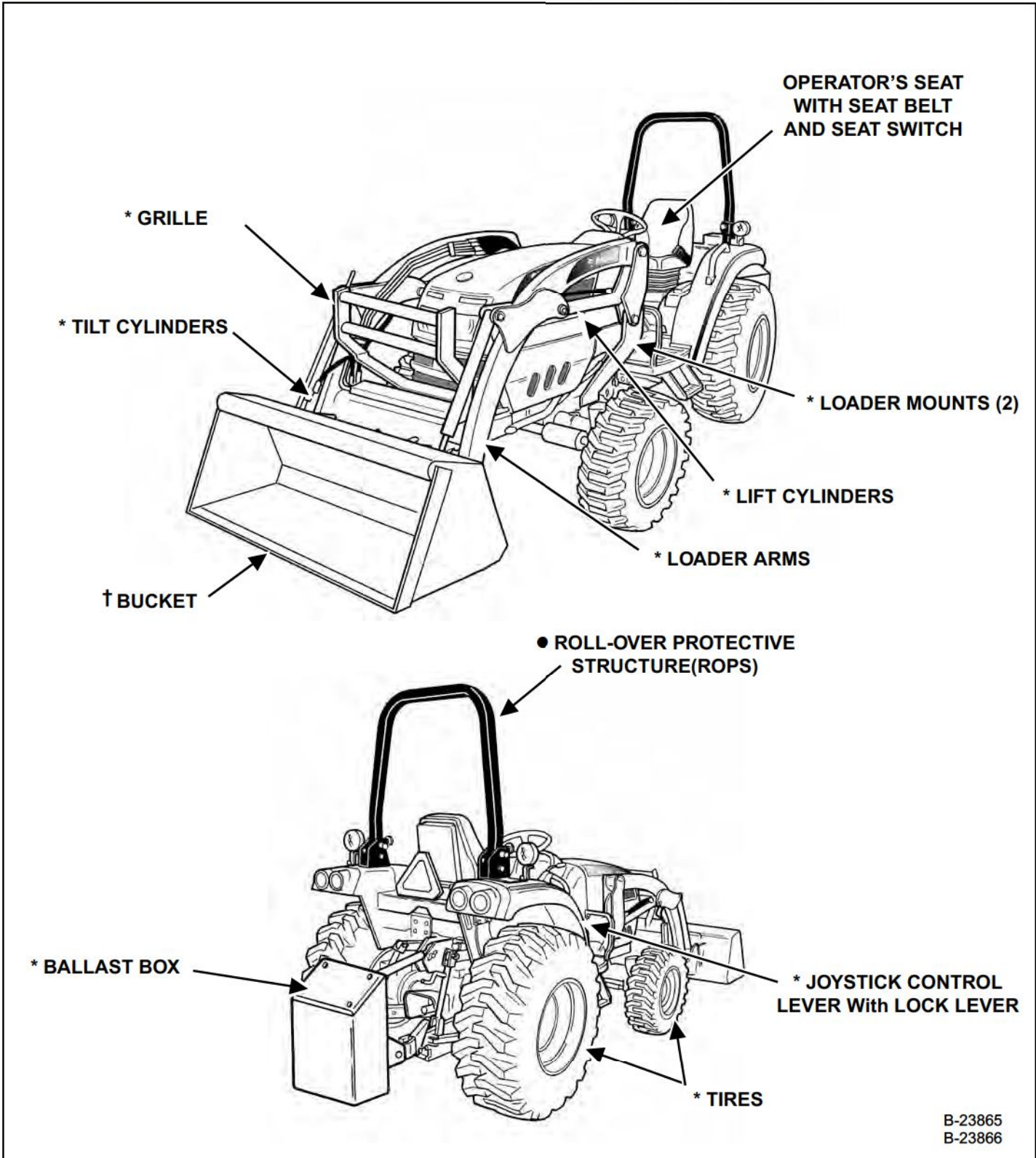

- † ATTACHMENTS AND IMPLEMENTS - Attachments and implements are available for the compact tractor.
- ROPS - Roll-Over Protective Structure, per ASABE S478 and OSHA 29 CFR PART 1928 Subpart C.
- * OPTIONAL OR FIELD ACCESSORIES (Not Standard Equipment) See Specification Page for tires with correct load rating.

Dealer Copy -- Not for Resale

B-23865
B-23866

COMPACT TRACTOR IDENTIFICATION (WITH OPTIONAL THREE-POINT IMPLEMENT AND FRONT BALLAST)

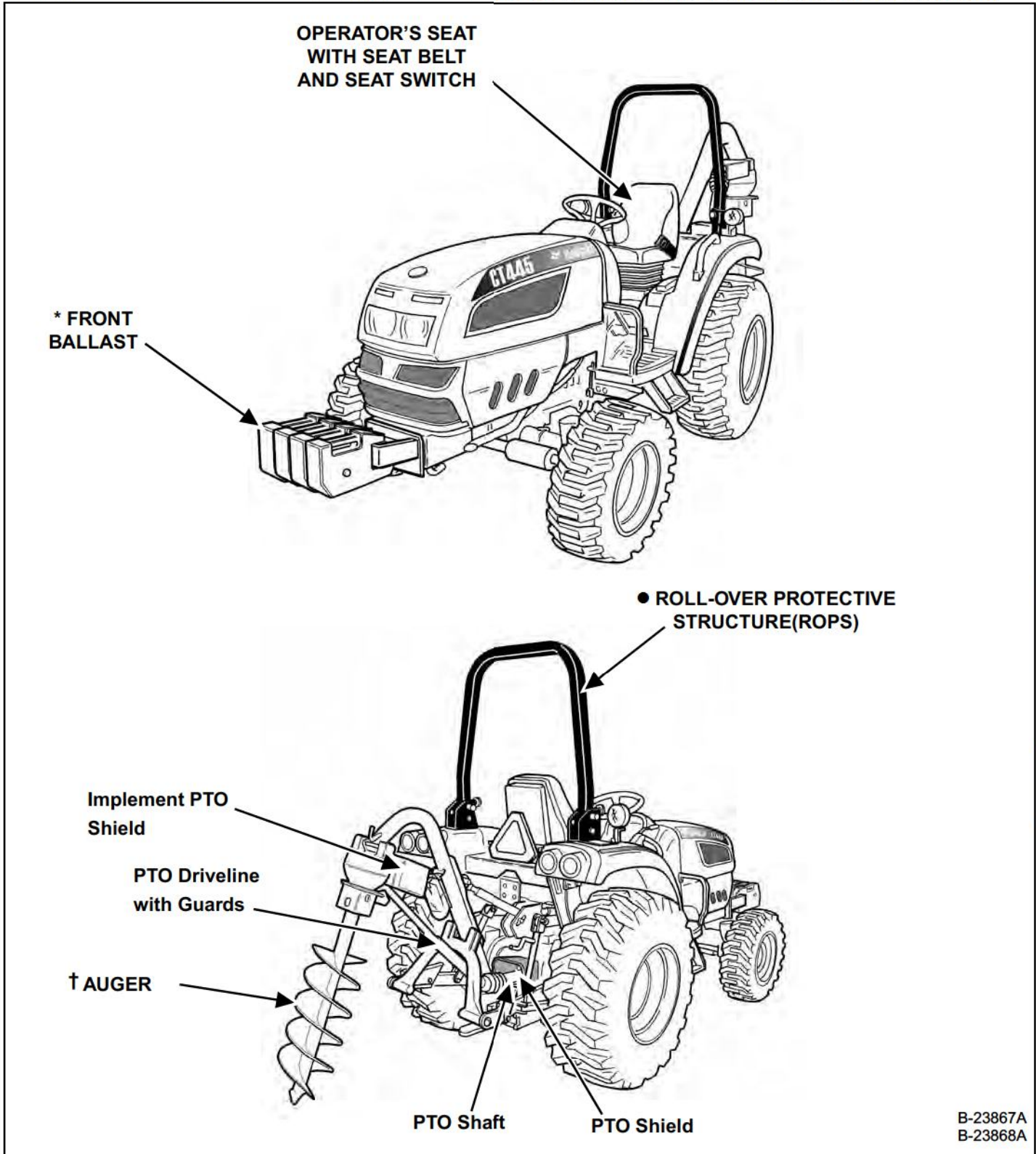

B-23867A
B-23868A

- † ATTACHMENTS AND IMPLEMENTS - Attachments and implements are available for the compact tractor.
- ROPS - Roll-Over Protective Structure, per ASABE S478 and OSHA 29 CFR PART 1928 Subpart C.
- * OPTIONAL OR FIELD ACCESSORIES (Not Standard Equipment).

Dealer Copy -- Not for Resale

COMPACT TRACTOR IDENTIFICATION (WITH OPTIONAL CAB)

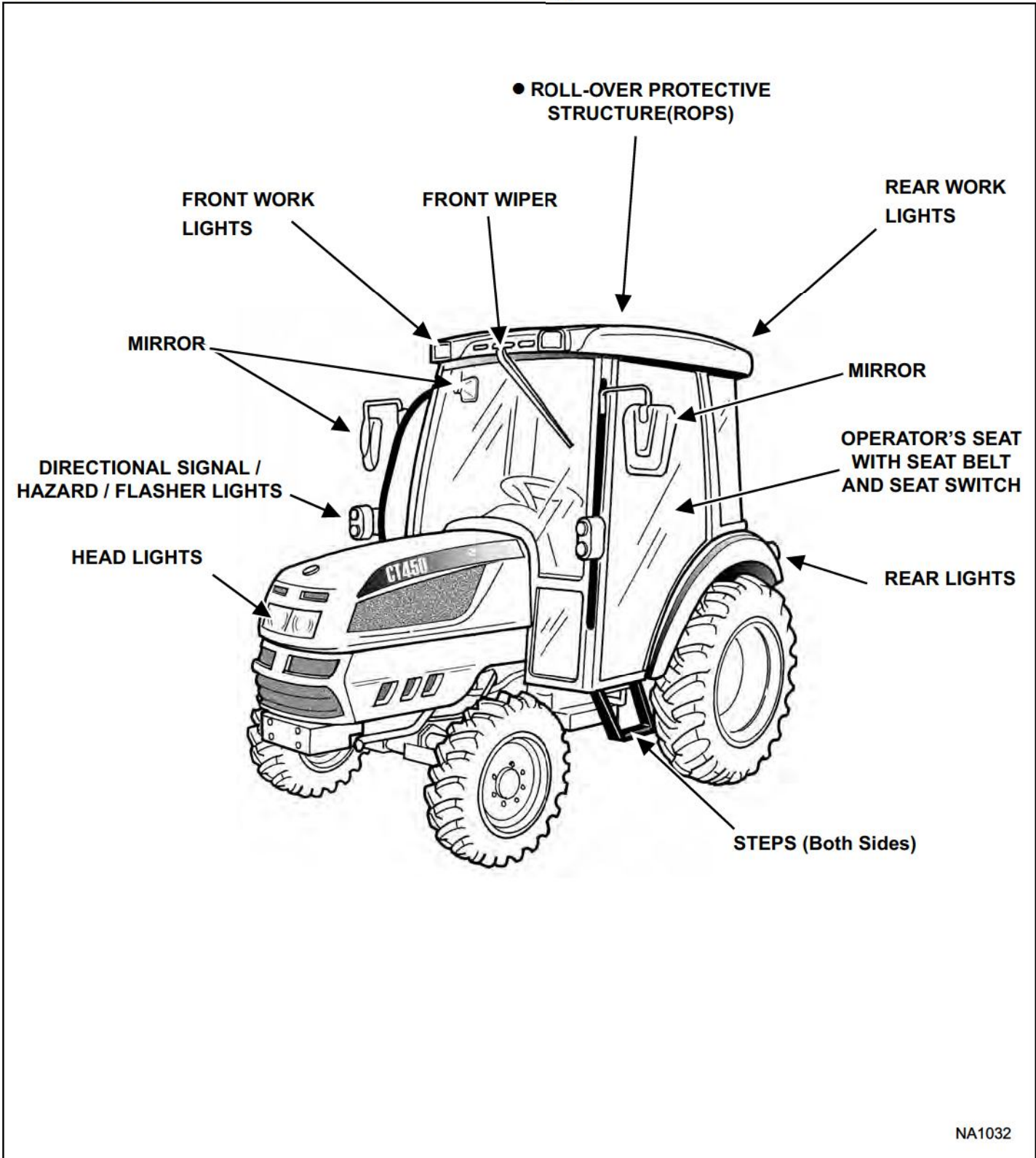

NA1032

† ATTACHMENTS AND IMPLEMENTS - Attachments and implements are available for the compact tractor.

● ROPS - Roll-Over Protective Structure, per ASABE S478 and OSHA 29 CFR PART 1928 Subpart C.

* OPTIONAL OR FIELD ACCESSORIES (Not Standard Equipment).

Dealer Copy -- Not for Resale

SAFETY & MAINTENANCE

SUPPORTING THE COMPACT TRACTOR ON JACKSTANDS	10-10-1
Procedure	10-10-1
ENGINE COVER	10-20-1
Opening And Closing	10-20-1
SEAT BELT	10-30-1
Inspection And Maintenance	10-30-1
TRANSPORTING THE COMPACT TRACTOR ON A TRAILER	10-40-1
Loading And Unloading	10-40-1
Fastening	10-40-2
TOWING THE COMPACT TRACTOR	10-50-1
Procedure	10-50-1
AXLE TOE IN (HST MODELS)	10-60-1
Inspection And Maintenance	10-60-1
AXLE TOE IN (SST MODELS)	10-61-1
Adjustment	10-61-1
SERVICE SCHEDULE	10-70-1
Chart	10-70-1
AIR CLEANER SERVICE	10-80-1
Replacing Filter Element	10-80-1
FRESH AIR FILTERS (WITH CAB)	10-81-1
Removal And Installation	10-81-1
ENGINE COOLING SYSTEM	10-90-1
Checking Level	10-90-1
Cleaning	10-90-2
Hoses And Clamps	10-90-2
Removing And Replacing Coolant	10-90-3
FUEL SYSTEM	10-100-1
Fuel Specifications	10-100-1
Biodiesel Blend Fuel	10-100-1
Filling The Fuel Tank	10-100-2
Fuel Filter	10-100-3
Removing Air From The Fuel System	10-100-4
Filling A Portable Fuel Container	10-100-4

ENGINE LUBRICATION SYSTEM	10-110-1
Checking And Adding Engine Oil	10-110-1
Engine Oil Chart	10-110-1
Removing And Replacing Oil And Filter	10-110-2
HYDRAULIC / HYDROSTATIC / TRANSMISSION SYSTEM	10-120-1
Checking And Adding Fluid	10-120-1
Transmission / Differential Fluid Chart	10-120-1
Removing And Replacing Hydraulic / Hydrostatic / Transmission Filters	10-120-2
Removing And Replacing Hydraulic / Transmission Fluid	10-120-3
Hoses And Clamps	10-120-3
FRONT AXLE	10-130-1
Checking And Adding Lubricant	10-130-1
Removing And Replacing Lubricant	10-130-2
Axle Pivot	10-130-2
SPARK ARRESTER MUFFLER	10-140-1
Cleaning Procedure	10-140-1
COMPACT TRACTOR STORAGE AND RETURN TO SERVICE	10-150-1
Storage	10-150-1
Return To Service	10-150-1
ALTERNATOR BELT	10-160-1
Belt Adjustment	10-160-1
Belt Replacement	10-160-1
AIR CONDITIONING BELT	10-161-1
Belt Adjustment	10-161-1
Belt Replacement	10-161-1
LUBRICATING THE COMPACT TRACTOR	10-170-1
Lubrication Locations	10-170-1
TIRE MAINTENANCE	10-180-1
Front Wheel Nuts / Bolts	10-180-1
Rear Wheel Nuts / Bolts	10-180-1
Mounting	10-180-1
Wheel Spacing (AG And Industrial Tires Only)	10-180-2
PIVOT PINS	10-190-1
Inspection And Maintenance	10-190-1
SAFETY INTERLOCK SYSTEM - NEUTRAL START	10-200-1
Inspection And Maintenance (HST)	10-200-1
Inspection And Maintenance (SST)	10-200-2

SAFETY INTERLOCK SYSTEM - OPERATING	10-210-1
Inspection And Maintenance (HST)	10-210-1
Inspection And Maintenance (SST)	10-210-2
PARKING BRAKE SYSTEM	10-220-1
Inspection And Maintenance	10-220-1
BRAKE SYSTEM	10-230-1
Inspection And Maintenance	10-230-1
Adjusting	10-230-3
TRAVEL CONTROL PEDAL (HST ONLY)	10-240-1
Inspection And Maintenance	10-240-1
F-N-R LEVER (SST ONLY)	10-241-1
Inspection And Maintenance	10-241-1
CRUISE CONTROL (HST ONLY)	10-250-1
Inspection And Maintenance	10-250-1
CLUTCH PEDAL (SST ONLY)	10-251-1
Inspection And Maintenance	10-251-1
SPEED RANGE LEVER (HST ONLY)	10-260-1
Calibration	10-260-1
BOB-TACH (HAND LEVER)	10-270-1
Inspection And Maintenance	10-270-1
CLUTCH PEDAL AND HOUSING (SST ONLY)	10-280-1
Draining Water	10-280-1
Storage Position	10-280-1
DIFFERENTIAL LOCK	10-290-1
Inspection And Maintenance	10-290-1
Adjustment	10-290-1

Dealer Copy -- Not for Resale

SUPPORTING THE COMPACT TRACTOR ON JACKSTANDS

Procedure

For service work under the compact tractor, or to remove the rims and tires, always support the compact tractor with jackstands or blocks of adequate capacity for the weight of compact tractor. (See Performance on Page SPEC-10-6.)

Park the compact tractor on a flat level surface.

Figure 10-10-1

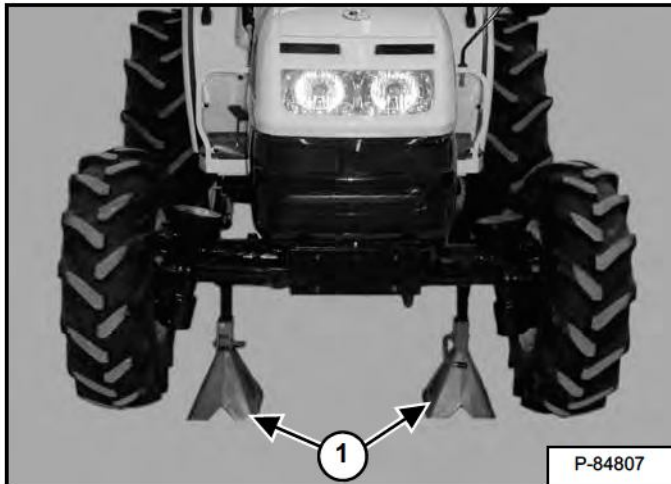
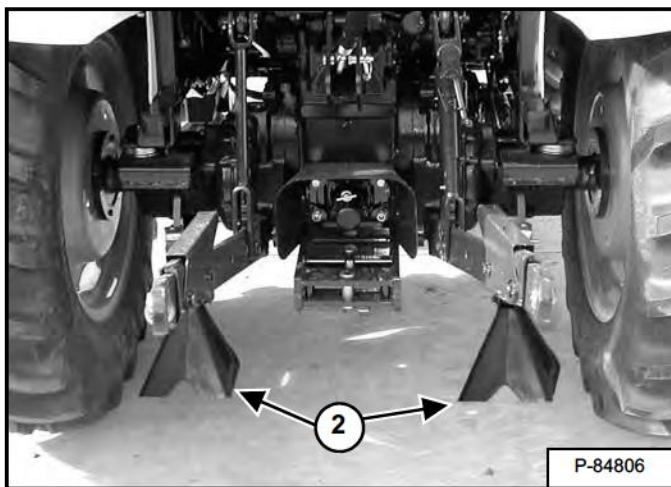

Figure 10-10-2



Put jackstands under the front and rear axles (Item 1) [Figure 10-10-1] and (Item 2) [Figure 10-10-2].

WARNING

AVOID INJURY OR DEATH

Instructions are necessary before operating or servicing machine. Read and understand the Operation & Maintenance Manual, Operator's Handbook and signs (decals) on machine. Follow warnings and instructions in the manuals when making repairs, adjustments or servicing. Check for correct function after adjustments, repairs or service. Untrained operators and failure to follow instructions can cause injury or death.

W-2003-0807

WARNING

AVOID INJURY OR DEATH

Put jackstands under the front and rear axles of the frame of the compact tractor before running the engine for service. Failure to use jackstands can allow the machine to fall or move.

W-2677-0907

Dealer Copy -- Not for Resale

ENGINE COVER

Opening And Closing

Opening

Figure 10-20-1

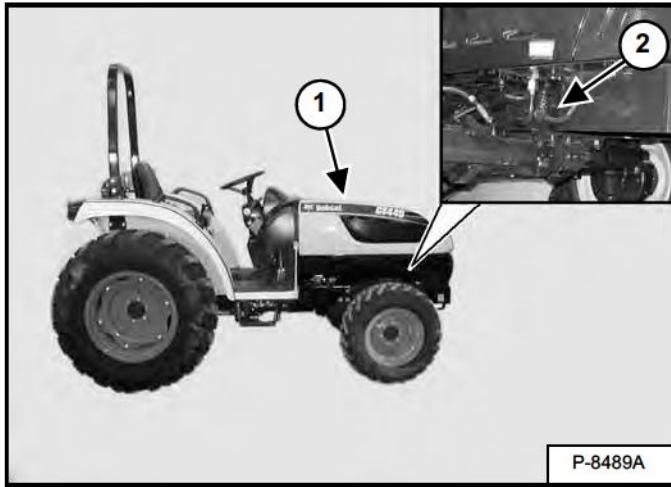

Then engine cover (Item 1) is opened by pulling down on the knob (Item 2) [Figure 10-20-1] and pushing down on the front of the engine cover. (The knob is located on the lower right side of the frame.)

Raise the front of the engine cover.

Closing

Figure 10-20-2

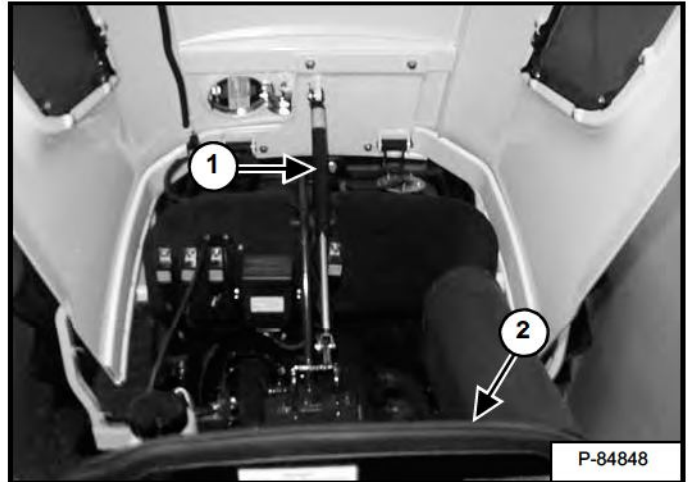

The engine cover is held open by a gas cylinder (Item 1) [Figure 10-20-2].

To lower the engine cover, push down on the front of the engine cover until it locks in the closed position [Figure 10-20-1].

NOTE: If hood rattles during operation, inspect the rubber moulding (Item 2) [Figure 10-20-2]. The moulding will need to be replaced if damaged or if the hood rattles during operation.

Dealer Copy -- Not for Resale

SEAT BELT

Inspection And Maintenance

WARNING

Failure to properly inspect and maintain the seat belt can cause lack of operator restraint resulting in serious injury or death.

W-2466-0703

Check the seat belt daily for correct function.

Inspect the seat belt system thoroughly yearly or more often if the machine is exposed to severe environmental conditions or applications.

The seat belt system should be repaired or replaced if it shows cuts, fraying, extreme or unusual wear, significant discolorations due to ultraviolet (UV) rays from the sun, dusty / dirty conditions, abrasion to the seat belt webbing, or damage to the buckle, latch plate, retractor (if equipped), hardware, or any other obvious problem should be replaced immediately.

Figure 10-30-1

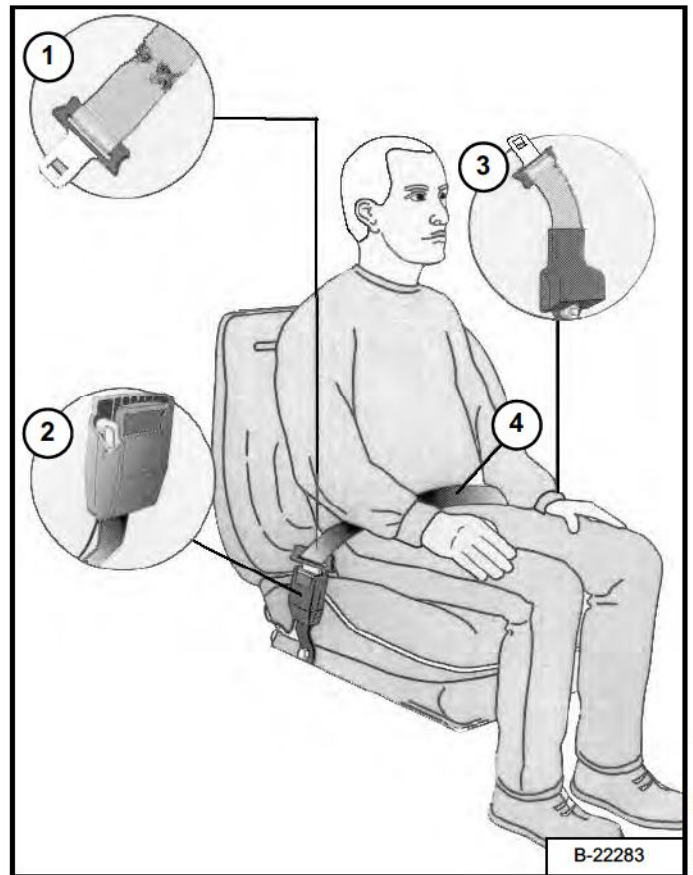

The items below are referenced in [Figure 10-30-1].

1. Check the seat belt webbing. If the system is equipped with a retractor, pull the webbing completely out and inspect the full length of the webbing. Look for cuts, wear, fraying, dirt and stiffness.
2. Check the buckle and latch for proper function. Make sure latch plate is not excessively worn, deformed or buckle is not damaged or casing broken.
3. Check the retractor web storage device (if equipped) by extending the seat belt webbing to determine if it extends and retracts the webbing correctly.
4. Check webbing in areas exposed to ultraviolet (UV) rays from the sun or extreme dust or dirt. If the original color of the webbing in these areas is extremely faded and / or the webbing is packed with dirt, the webbing strength may have weakened.

Dealer Copy -- Not for Resale

TRANSPORTING THE COMPACT TRACTOR ON A TRAILER

Loading And Unloading

! WARNING

AVOID SERIOUS INJURY OR DEATH

Adequately designed ramps of sufficient strength are needed to support the weight of the machine when loading onto a transport vehicle. Wood ramps can break and cause personal injury.

W-2058-0807

IMPORTANT

Remove sunshade before transporting compact tractor at highway speeds. Sunshade damage may occur if left installed.

I-2258-0607

Be sure the transport and towing vehicles are of adequate size and capacity for weight of machine. (See CT440 SPECIFICATIONS (HST) on Page SPEC-10-1.) OR (See CT445 SPECIFICATIONS (HST) on Page SPEC-11-1.) OR (See CT445 SPECIFICATIONS (sST) on Page SPEC-12-1.)

Figure 10-40-1

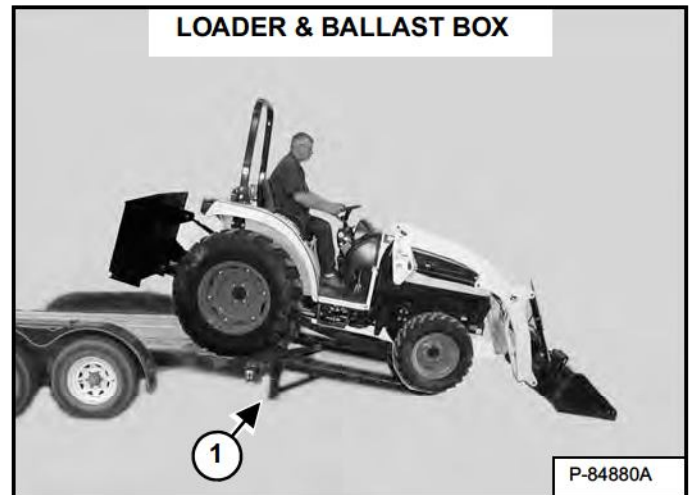
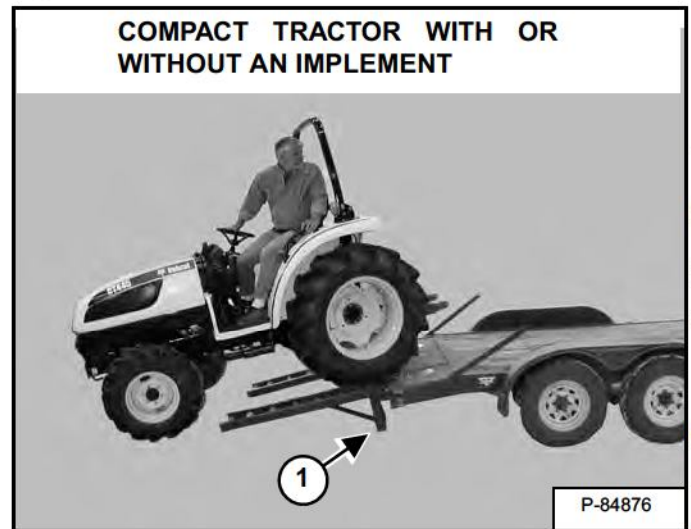

Figure 10-40-2



Dealer Copy -- Not for Resale

A compact tractor with a loader, attachment and rear ballast must be loaded backward onto the trailer [Figure 10-40-1].

A compact tractor with or without an implement must be loaded backward [Figure 10-40-2].

The rear of the trailer must be blocked or supported (Item 1) [Figure 10-40-1] and [Figure 10-40-2] when loading or unloading to prevent the front end of the trailer from raising up.

TRANSPORTING THE COMPACT TRACTOR ON A TRAILER (CONT'D)

Fastening

WARNING

AVOID INJURY OR DEATH

Before you leave the operator's seat:

- Fully lower the loader arms, put the attachment flat on the ground (if equipped).
- Fully lower the implement(s) to the ground (if equipped).
- Lock brake pedals together and engage the parking brake.
- Place F-N-R lever in neutral (SST models only).
- Place all controls in neutral.
- Stop the engine, unfasten the seat belt and remove the key.

W-2569-0909

Use the following procedure to fasten the compact tractor to the transport vehicle to prevent it from moving during turns, sudden stops or when going up and down slopes.

Fully lower the loader arms and put the attachment flat on the tow vehicle.

Fully lower the mid-mount implement (if equipped).

Fully lower the three-point hitch implement (if equipped).

Lock brake pedals together and engage the parking brake.

Place all controls in neutral.

Stop the engine and exit the compact tractor.

Figure 10-40-3

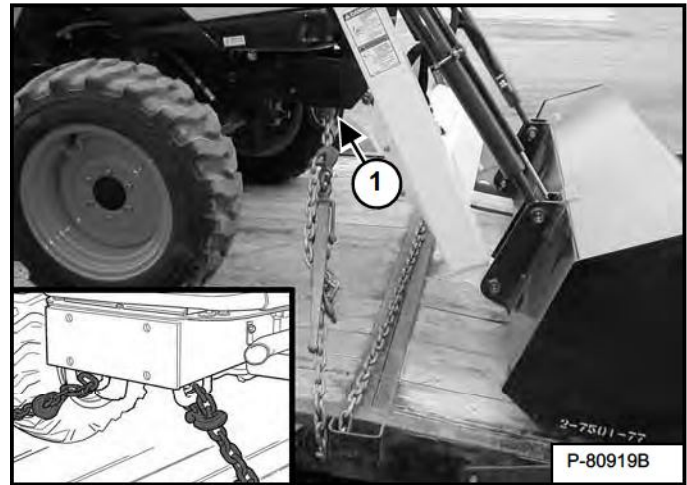

Fasten at the front of the compact tractor using the front chain loops (Item 1) [Figure 10-40-3] and to the transport vehicle (both sides).

WARNING

AVOID INJURY OR DEATH

The parking brake must be engaged before leaving the operator's seat. Rollaway can occur because the transmission may not prevent machine movement. Lock the brake pedals together before activating the parking brake.

W-2656-0807

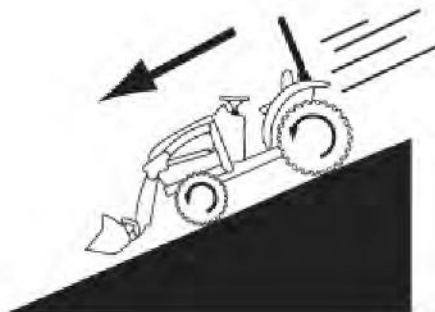



Suggest:

If the above button click is invalid.

Please download this document

first, and then click the above link

to download the complete manual.

Thank you so much for reading

TRANSPORTING THE COMPACT TRACTOR ON A TRAILER (CONT'D)

Fastening (Cont'd)

Figure 10-40-4

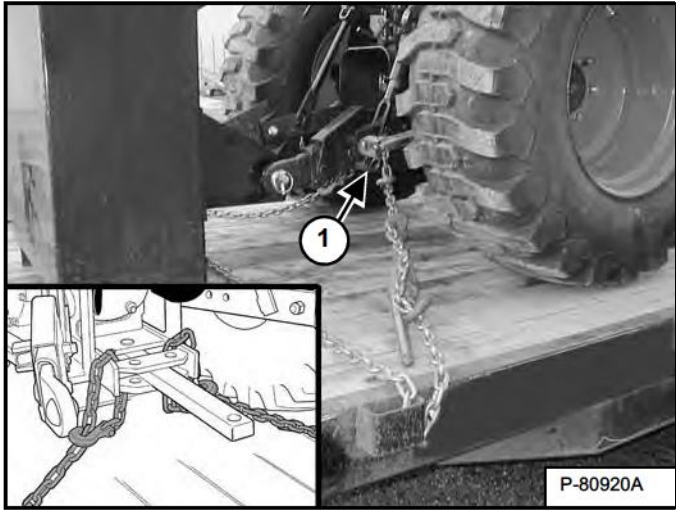

Fasten the rear of compact tractor using the drawbar mounting frame (Item 1) [Figure 10-40-4] and to the transport vehicle (both sides).

When using chains, use chain binders to tighten the chains and then secure the chain binder levers to prevent loosening.

TOWING THE COMPACT TRACTOR

Procedure

IMPORTANT

Never tow the compact tractor faster than 16 km/h (10 mph). Always have someone seated to steer and brake the towed compact tractor.

Tow the compact tractor for short distances only.

I-2263-0910

NOTE: When the engine is not running, turning the steering wheel will require more effort. Power steering assist is not available when the engine is OFF.

Install a tow chain (or cable) to the front (for towing in the forward direction) or to the drawbar (for towing in the rearward direction).

The tow chain (or cable) must be rated at 1.5 times the weight of the compact tractor and implement / attachment. (See CT440 SPECIFICATIONS (HST) on Page SPEC-10-1.) OR (See CT445 SPECIFICATIONS (HST) on Page SPEC-11-1.) OR (See CT445 SPECIFICATIONS (sST) on Page SPEC-12-1.)

Enter the compact tractor and fasten the seat belt. Move both the rear and the mid-PTO levers to the disengaged (OFF) position.

Disengage the front wheel assist.

Move the speed range lever to neutral. Place all controls in neutral.

For SST Model Only: Move the F-N-R lever to neutral (N) and the gear shift lever to neutral.

Disengage the parking brake (but leave the brake pedals locked together for slowing or stopping the compact tractor).

Always have an operator seated in the operator's seat to operate the steering and brakes while towing the compact tractor. Use ROPS and fasten seat belt. Engage the parking brake and stop the engine before leaving the machine.

If the compact tractor is equipped with a loader or has an implement attached and the engine can not be started, tow the compact tractor using one of the following procedures.

Towing Compact Tractor With Loader Installed;

If possible, slightly raise the attachment off of the ground. The compact tractor will need to be towed backwards (if possible), to avoid the bucket (or attachment) from digging into the ground while towing.

Use the towing procedure described but install the tow chain to the rear of the compact tractor and tow backwards.

Towing Compact Tractor With Implement Installed;

If the engine can be started, slightly raise the implement off of the ground. The type of implement will determine which direction to tow the compact tractor.

Implements that dig into the ground will be difficult to tow and may require the implement to be disconnected from the compact tractor before towing. (Example; plow or cultivator.) If the implement must be removed before towing, use the procedure described previously and tow forward to get the compact tractor away from the implement.

NOTE: Do not connect the tow chain (or cable) to the loader, attachment or the implement. Connect to the compact tractor only as shown. The rated strength of the tow chain or cable must be rated at 1.5 times the weight of the engine towed load (compact tractor plus the attachment or implement installed). Add the weight of the compact tractor, the loader, the attachment and / or the implement together for the total machine weight to calculate the strength of the tow chain or cable needed.

Dealer Copy -- Not for Resale

<https://www.ebooklibonline.com>

Hello dear friend!

Thank you very much for reading.

Enter the link into your browser.

The full manual is available for immediate download.

<https://www.ebooklibonline.com>