

B300

B-Series



Bobcat®

Service Manual

(S/N 572311001 & Above)

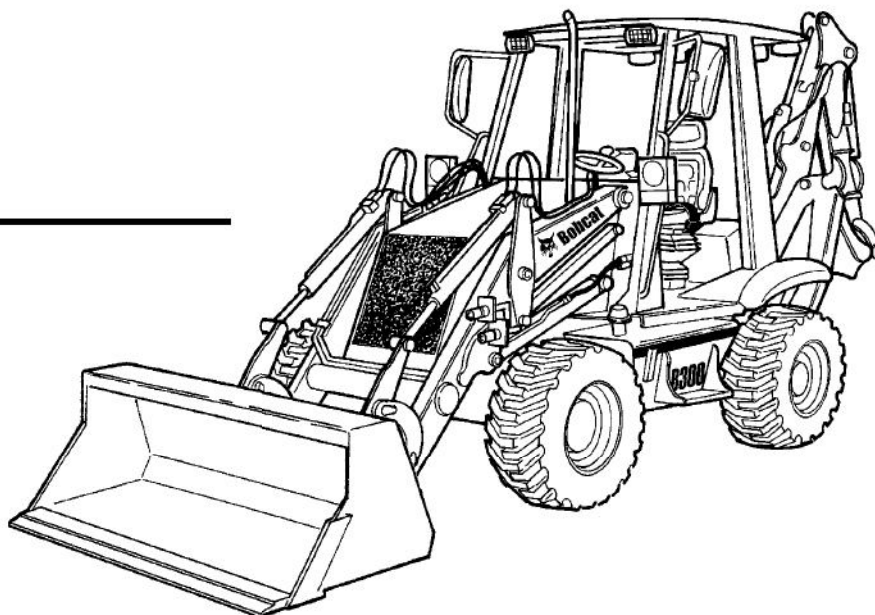

Doosan purchased Bobcat Company from Ingersoll-Rand Company in 2007. Any reference to Ingersoll-Rand Company or use of trademarks, service marks, logos, or other proprietary identifying marks belonging to Ingersoll-Rand Company in this manual is historical or nominative in nature, and is not meant to suggest a current affiliation between Ingersoll-Rand Company and Bobcat Company or the products of either.



Printed in U.S.A.

MAINTENANCE SAFETY



WARNING

Instructions are necessary before operating or servicing machine. Read and understand the Operation & Maintenance Manual, Operator's Handbook and signs (decals) on machine. Follow warnings and instructions in the manuals when making repairs, adjustments or servicing. Check for correct function after adjustments, repairs or service. Untrained operators and failure to follow instructions can cause injury or death.

W-2003-0903



Safety Alert Symbol: This symbol with a warning statement, means: "Warning, be alert! Your safety is involved!" Carefully read the message that follows.

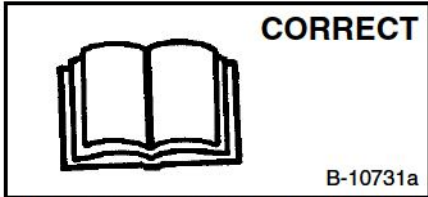

⚠ Never service the Bobcat Loader Backhoe without instructions.

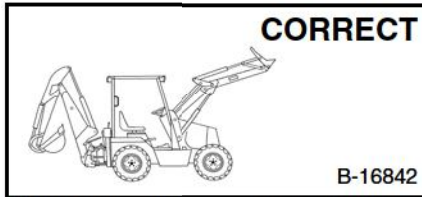

⚠ Always use an approved lift arm support device when servicing the loader backhoe with the lift arms raised. Replace the lift arm support device if damaged or missing.

⚠ Disconnecting or loosening any hydraulic tubeline, hose, fitting component, or part failure can cause lift arms or backhoe boom to drop.

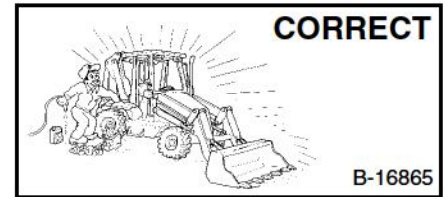

⚠ Cleaning and maintenance are required daily.

⚠ NEVER modify equipment or add attachments not approved by Bobcat.



⚠ Have good ventilation when welding or grinding painted parts.

⚠ Wear dust mask when grinding painted parts. Toxic dust and gas can be produced.



⚠ Vent exhaust to outside when engine must be run for service.

⚠ Exhaust system must be tightly sealed. Exhaust fumes can kill without warning.

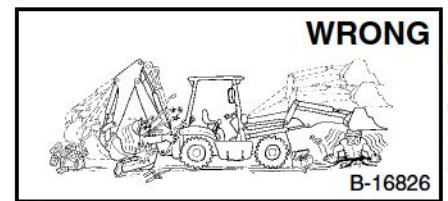

⚠ Never work on loader backhoe with lift arms raised unless supported by an approved lift arm support device.

⚠ Always lower the backhoe bucket to the ground before doing any maintenance.

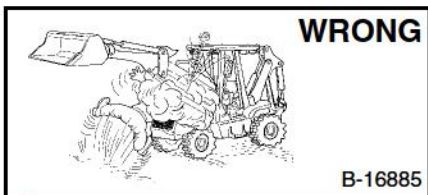

⚠ Stop, cool and clean engine of flammable materials before checking fluids.

⚠ Never service or adjust machine with the engine running unless instructed to do so in the manual.

⚠ Avoid contact with leaking hydraulic fluid or diesel fuel under pressure. It can penetrate the skin or eyes.

⚠ Never fill fuel tank with engine running, while smoking or when near open flame.

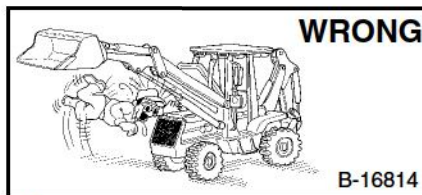

⚠ Keep body, jewelry and clothing away from moving parts, electrical contact, hot parts and exhaust.

⚠ Wear eye protection to guard from battery acid, compressed springs, fluids under pressure and flying debris when engines are running or tools are used.

⚠ Use eye protection approved for type of welding.

⚠ Keep engine cover closed except for service. Close and latch engine cover before operating the loader backhoe.

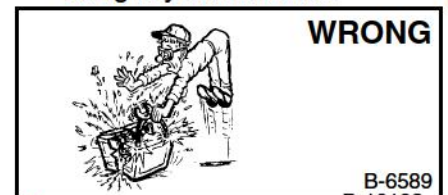

⚠ Lead-acid batteries produce flammable and explosive gases.

⚠ Keep arcs, sparks, flames and lighted tobacco away from batteries.

⚠ Batteries contain acid which burns eyes or skin on contact. Wear protective clothing. If acid contacts body, flush well with water. For eye contact flush well and get immediate medical attention.

Maintenance procedures which are given in the Operation & Maintenance Manual can be performed by the owner/operator without any specific technical training. Maintenance procedures which are not in the Operation & Maintenance Manual must be performed **ONLY BY QUALIFIED BOBCAT SERVICE PERSONNEL**. Always use genuine Bobcat replacement parts.

MSW19-0605

Dealer Copy -- Not for Resale

ALPHABETICAL INDEX

AIR CLEANER	70-01	HYDRAULIC FLUID RESERVOIR	20-01
AIR CLEANER SERVICE	10-01	HYDRAULIC SYSTEM INFORMATION	20-01
ALTERNATOR	60-01	HYDRAULIC/HYDROSTATIC FLUID	
ALTERNATOR BELT	10-01	SPECIFICATIONS	SPEC-01
APPROVED LIFT ARM SUPPORT DEVICE	10-01	HYDRAULIC/HYDROSTATIC SYSTEM.....	10-01
ARM CYLINDER	20-01	HYDROSTATIC DRIVE MOTOR	30-01
ARM	50-01	HYDROSTATIC PUMP	30-01
AXLE TOE-IN.....	10-01	HYDROSTATIC SYSTEM INFORMATION.....	30-01
		HYDROSTATIC TESTING	30-01
BACKHOE CONTROL VALVE.....	20-01		
BATTERY	60-01	INSTRUMENT PANEL.....	60-01
BOB-TACH.....	50-01		
BOB-TACH HAND LEVER.....	10-01	LIFT ARMS	50-01
BOOM	50-01	LIFT ARM STABILIZER	50-01
BOOM CYLINDER	20-01	LIFT CYLINDER	20-01
BOOM LOCK PIN	10-01	LIFTING AND BLOCKING THE	
BUCKET	50-01	LOADER BACKHOE	10-01
BUCKET CYLINDER	20-01	LOADER BACKHOE SPECIFICATIONS.....	SPEC-01
BUCKET POSITIONING LINK.....	50-01	LOADER BACKHOE TORQUE	SPEC-01
		LOADER CONTROL VALVE	20-01
CAB LIGHTS.....	60-01	LUBRICATING THE LOADER BACKHOE	10-01
CENTER FLOOR PANEL	50-01		
CONVERSIONS	SPEC-01	MAIN RELIEF VALVE	20-01
		MASTER CYLINDER	20-01
DRIVE COUPLER.....	70-01	MUFFLER.....	70-01
DRIVESHAFT	40-01		
DROP BOX	40-01	OIL COOLER.....	30-01
		OPERATOR CANOPY.....	50-01
ELECTRICAL SYSTEM INFORMATION	60-01	OPERATOR SEAT	50-01
ENCLOSED CAB	50-01		
ENGINE	70-01	PARKING BRAKE HOUSING.....	40-01
ENGINE COMPONENTS AND TESTING	70-01	PORT RELIEF VALVE	
ENGINE COOLING SYSTEM.....	10-01	(BACKHOE CONTROL VALVE)	20-01
ENGINE COVER	10-01, 50-01		
ENGINE LUBRICATION SYSTEM.....	10-01	RADIATOR	70-01
ENGINE SIDE COVERS.....	50-01	REAR AXLE	10-01, 40-01
ENGINE SPECIFICATIONS.....	SPEC-01	RECONDITIONING THE ENGINE	70-01
ENGINE SPEED CONTROL	70-01		
		SERVICE SCHEDULE	10-01
FENDER	50-01	STABILIZER	50-01
FLOOR PANELS.....	50-01	STABILIZER CYLINDER (FRONT & REAR).....	20-01
FLYWHEEL	70-01	STEERING CYLINDER	20-01
FLYWHEEL HOUSING	70-01	STEERING PUMP	20-01
FRONT AXLE	10-01, 40-01	STEERING VALVE	20-01
FRONT AXLE PIVOT FRAME	50-01	STARTER	60-01
FRONT LIGHTS.....	60-01	SWING CYLINDER	20-01
FUEL LEVEL SENDER.....	60-01	SWING FRAME	50-01
FUEL SYSTEM	10-01		
FUEL TANK.....	50-01	TILT CYLINDER	20-01
		TIRE MAINTENANCE	10-01
GEAR PUMP	20-01	TORQUE SPECIFICATIONS	
GRILL.....	50-01	FOR BOLTS.....	SPEC-01
GRILL FRAME	50-01	TOWING THE LOADER BACKHOE	10-01
		TRANSPORTING THE LOADER BACKHOE.....	10-01
HYDRAULIC FILTER	20-01	TRAVEL PEDAL	70-01
HYDRAULIC FILTER HOUSING	20-01		

Dealer Copy -- Not for Resale

ALPHABETICAL INDEX (CONT'D)

TROUBLESHOOTING.....40-01, 70-01
TURBO70-01
TURN INDICATOR LIGHTS (FRONT).....60-01
TURN INDICATOR LIGHTS (REAR).....60-01

X-CHANGE™50-01

Dealer Copy -- Not for Resale

<https://www.ebooklibonline.com>

Hello dear friend!

Thank you very much for reading.

Enter the link into your browser.

The full manual is available for immediate download.

<https://www.ebooklibonline.com>

CONTENTS

FOREWORD.....	II
SAFETY INSTRUCTIONS	V
SERIAL NUMBER LOCATION	IX
DELIVERY REPORT.....	X
LOADER BACKHOE IDENTIFICATION	XI
SAFETY AND MAINTENANCE.....	10-01
HYDRAULIC SYSTEM	20-01
HYDROSTATIC SYSTEM.....	30-01
DRIVE SYSTEM	40-01
MAIN FRAME	50-01
ELECTRICAL SYSTEM AND ANALYSIS	60-01
ENGINE SERVICE	70-01
SPECIFICATIONS.....	SPEC-01

**SAFETY &
MAINTENANCE**

**HYDRAULIC
SYSTEM**

**HYDROSTATIC
SYSTEM**

**DRIVE
SYSTEM**

MAIN FRAME

**ELECTRICAL
SYSTEM &
ANALYSIS**













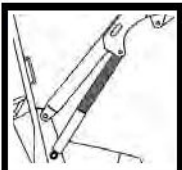
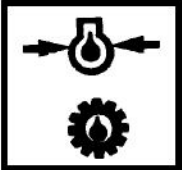

**ENGINE
SERVICE**

SPECIFICATIONS

FOREWORD

This manual is for the Bobcat loader mechanic. It provides necessary servicing and adjustment procedures for the Bobcat loader and its component parts and systems. Refer to the Operation & Maintenance Manual for operating instructions, Starting procedure, daily checks, etc.

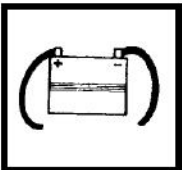
A general inspection of the following items must be made after the loader has had service or repair:

- | | |
|--|---|
| <p>1. Check that ROPS mounting hardware is tightened and is Bobcat approved.</p> | <p>9. Bob-Tach wedges and linkages must function correctly and be in good condition.</p> |
|  |  |
| <p>2. The seat belt must be correctly installed, functional and in good condition.</p> | <p>10. Safety treads must be in good condition.</p> |
|  |  |
| <p>3. Check lift arm support device, replace if damaged.</p> | <p>11. Check for correct function of indicator lamps (Optional on some models).</p> |
|  |  |
| <p>4. Machine signs must be legible and in the correct location.</p> | <p>12. Check hydraulic fluid level, engine oil level and fuel supply.</p> |
|  |  |
| <p>5. Foot pedal must return to neutral.</p> | <p>13. Inspect for fuel, oil or hydraulic fluid leaks.</p> |
|  |  |
| <p>6. Check for correct function of the work lights</p> | <p>14. Lubricate the loader backhoe.</p> |
|  |  |
| <p>7. The parking brake must function correctly.</p> | <p>15. Check the condition of the battery and cables.</p> |
|  |  |
| <p>8. Enclosure door latches must open and close freely.</p> | <p>16. Inspect the air cleaner for damage or leaks. Check the condition of the element.</p> |
|  |  |

Dealer Copy -- Not for Resale

17. Check the electrical charging system.

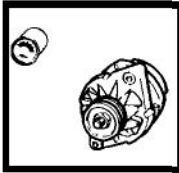

20. Operate the loader and check all functions.



18. Check tires for wear and pressure.

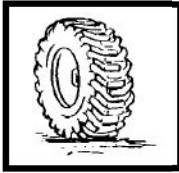

21. Check for any field modification not completed.



19. Inspect for loosen or broken parts or connections.



22. Recommend to the owner that all necessary corrections be made before the machine is returned to service.



**CALIFORNIA
PROPOSITION 65 WARNING**
Diesel engine exhaust and some of its constituents are known to the State of California to cause cancer, birth defects and other reproductive harm.

SAFETY INSTRUCTIONS



Safety Alert Symbol

This symbol with a warning statement means:
“Warning, be alert! Your safety is involved!”
Carefully read the message that follows.



WARNING

Instructions are necessary before operating or servicing machine. Read and understand the Operation & Maintenance Manual, Operator's Handbook and signs (decals) on machine. Follow warnings and instructions in the manuals when making repairs, adjustments or servicing. Check for correct function after adjustments, repairs or service. Untrained operators and failure to follow instructions can cause injury or death.

W-2003-0903



WARNING

Warnings on the machine and in the manuals are for your safety. Failure to obey warnings can cause injury or death.

W-2044-1285

IMPORTANT

This notice identifies procedures which must be followed to avoid damage to the machine.

I-2019-0284

The following publications provide information on the safe use and maintenance of the Bobcat machine and attachments:

- The Delivery Report is used to assure that complete instructions have been given to the new owner and that the machine is in safe operating condition.
- The Operation & Maintenance Manual delivered with the machine or attachment contains operating information as well as routine maintenance and service procedures. It is a part of the machine and can be stored in a container provided on the machine. Replacement Operation & Maintenance Manuals can be ordered from your Bobcat dealer.
- Machine signs (decals) instruct on the safe operation and care of your Bobcat machine or attachment. The signs and their locations are shown in the Operation & Maintenance Manual. Replacement signs are available from your Bobcat dealer.
- An Operator's Handbook fastened to the operator cab. It's brief instructions are convenient to the operator. The handbook is available from your dealer in an English edition or one of many other languages. See your Bobcat dealer for more information on translated versions.
- The AEM Safety Manual delivered with the machine gives general safety information.
- The Service Manual and Parts Manual are available from your dealer for use by mechanics to do shop-type service and repair work.
- The Loader Backhoe Operator Training Course is available through your local dealer or at www.training.bobcat.com or www.bobcat.com. This course is intended to provide rules and practices of correct operation of the Loader Backhoe.
- The Loader Backhoe Safety Video is available from your Bobcat dealer or at www.training.bobcat.com or www.bobcat.com.

Dealer Copy -- Not for Resale

SI LB-0206 SM

B300 Bobcat Loader Backhoe
Service Manual

SAFETY INSTRUCTIONS (CONT'D)

Fire Prevention

The machine and attachments have components that are at high temperature under normal operating conditions. The primary source of high temperatures is the engine and exhaust system. The electrical system, if damaged or incorrectly maintained, can be a source of arcs or sparks.

Flammable debris (leaves, straw, etc.) must be removed regularly. If flammable debris is allowed to accumulate, it will increase fire hazard. Clean often to avoid this accumulation. Flammable debris in the engine compartment is a potential hazard.

The spark arrestor muffler is designed to control the emission of hot particles from the engine and exhaust system, but the muffler and the exhaust gases are still hot.

- Do not use the machine where exhaust, arcs, sparks or hot components can contact flammable material, explosive dust or gases.
- The operator cab, engine compartment, and engine cooling system must be inspected every day and cleaned if necessary to prevent fire hazard and overheating.
- Check all electrical wiring and connections for damage. Keep the battery terminals clean and tight. Repair or replace any damaged part.
- Check fuel and hydraulic tubes, hoses and fittings for damage and leakage. Never use open flame or bare skin to check for leaks. Tighten or replace any parts that show leakage. Always clean fluid spills. Do not use gasoline or diesel fuel for cleaning parts. Use commercial nonflammable solvents.
- Do not use ether or starting fluids on any engine which has glow plugs. These starting aids can cause explosion and injure you or bystanders.
- Always clean the machine, disconnect the battery, and disconnect the wiring from the controllers before welding. Cover rubber hoses, battery and all other flammable parts. Keep a fire extinguisher near the machine when welding. Have good ventilation when grinding or welding painted parts. Wear a dust mask when grinding painted parts. Toxic dust or gas can be produced.
- Stop the engine and let it cool before adding fuel. **NO SMOKING!**

- Use the procedure in the Operation & Maintenance Manual for connecting the battery and for jump starting.
- Use the procedure in the Operation & Maintenance Manual for cleaning the spark arrestor muffler (if equipped).

Figure 1

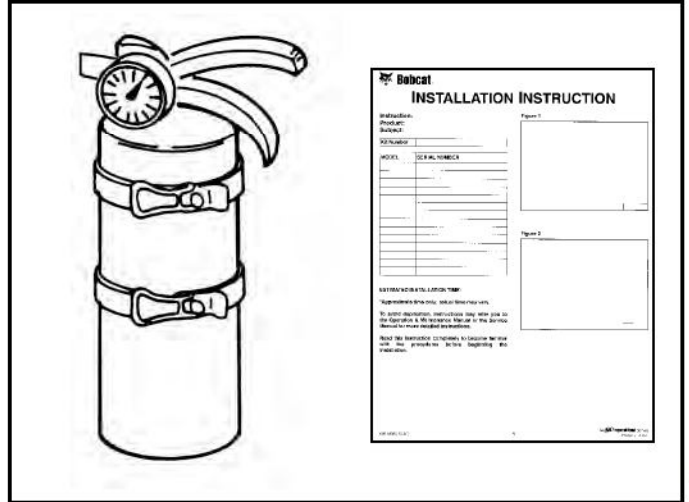

- Know where fire extinguishers and first aid kits are located and how to use them. Fire extinguishers are available from your Bobcat dealer [Figure 1].

Dealer Copy -- Not for Resale

SERIAL NUMBER LOCATION

Always use the serial number of the loader backhoe when requesting service information or when ordering parts. Early or later models (identification made by serial number) may use different parts, or it may be necessary to use a different procedure in doing a specific service operation.

Loader Backhoe Serial Number

Figure 1

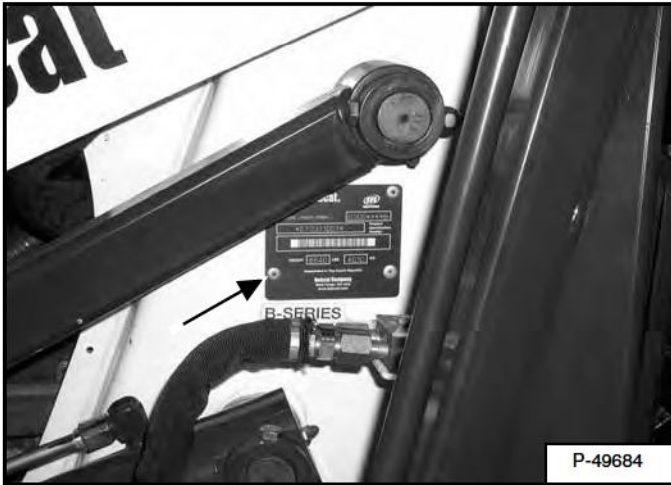

The loader backhoe serial number plate is located under the loader lift arm on the left side [Figure 1].

Explanation of loader Serial Number:

XXXX	XXXXX
Model 1.-Model/ Engine Combination	Model 2.-Production Sequence (Series)

1. The four digit Model/Engine Combination Module number identifies the model number and engine combination.
2. The five digit Production Sequence Number identifies the order which the loader is produced.

Engine Serial Number

Figure 2

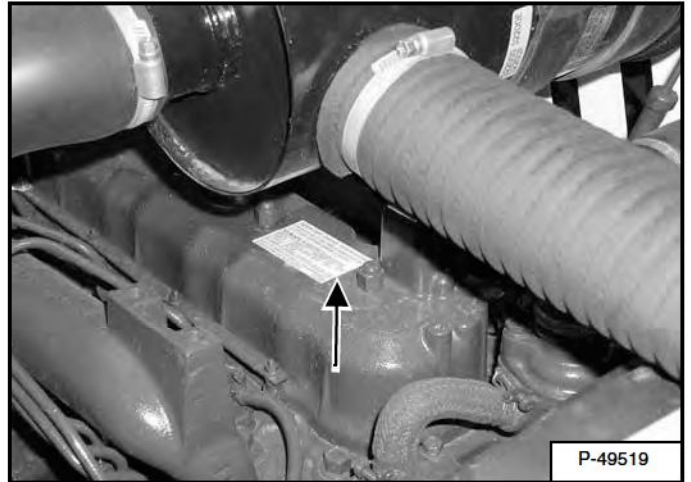

The engine serial number is located on the valve cover at the right side of the engine [Figure 2].

DELIVERY REPORT

Figure 3

B-16315

The Delivery Report must be filled out by the dealer and signed by the owner or operator when the Bobcat loader backhoe is delivered. An explanation of the form must be given to the owner. Make sure it is filled out completely [Figure 3].

LOADER BACKHOE IDENTIFICATION

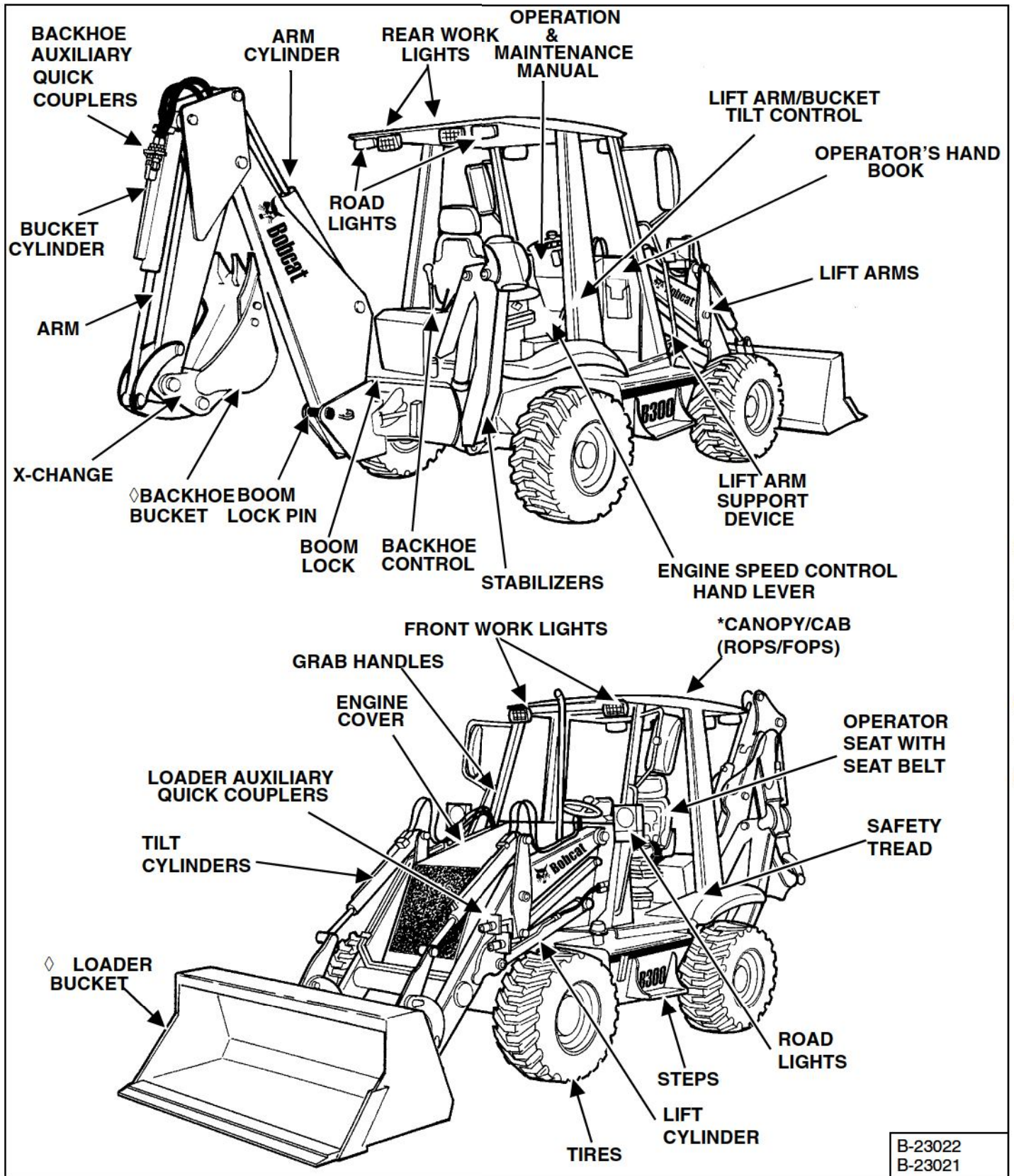

Dealer Copy -- Not for Resale

◇ BUCKET - Several different buckets and other attachments are available for the Bobcat loader backhoe.

* Roll Over Protective Structure (ROPS) per SAE J1040 and ISO 3471 and Falling Object Protective Structure (FOPS) per ISO 3449, Level I.

SAFETY AND MAINTENANCE

AIR CLEANER SERVICE 10-80-1
 Replacing The Filter 10-80-1

ALTERNATOR BELT 10-160-1
 Adjusting The Alternator Belt 10-160-1

APPROVED LIFT ARM SUPPORT DEVICE 10-20-1
 Installing The Approved Lift Arm Support Device 10-20-1
 Removing The Approved Lift Arm Support Device 10-20-2

AXLE TOE-IN 10-60-1
 Procedure 10-60-1

BOB-TACH HAND LEVER 10-150-1
 Inspection And Maintenance 10-150-1

BOOM LOCK PIN 10-140-1
 Engaging And Disengaging The Pin 10-140-1

ENGINE COOLING SYSTEM 10-90-1
 Coolant Replacement 10-90-1

ENGINE COVER 10-30-1

ENGINE LUBRICATION SYSTEM 10-110-1
 Checking Engine Oil 10-110-1
 Oil Chart 10-110-1
 Replacing Oil And Filter 10-110-2

FUEL SYSTEM 10-100-1
 Filling The Fuel Tank 10-100-1
 Fuel Filter 10-100-2
 Fuel Specifications 10-100-1
 Removing Air From The Fuel System 10-100-2

HYDRAULIC/HYDROSTATIC SYSTEM 10-120-1
 Checking And Adding Fluid 10-120-1
 Cleaning The Cooler 10-120-1
 Replacing Hydraulic Fluid 10-120-3
 Replacing Hydraulic/Hydrostatic Filter 10-120-2

LIFTING AND BLOCKING THE LOADER BACKHOE 10-10-1
 Procedure 10-10-1

Continued On Next Page

Dealer Copy -- Not for Resale

SAFETY AND MAINTENANCE

LUBRICATING THE LOADER BACKHOE	10-170-1
REAR AXLE	10-130-1
Checking Oil Level	10-130-1
Draining Oil	10-130-1
SERVICE SCHEDULE	10-70-1
Chart	10-70-1
TIRE MAINTENANCE	10-180-1
Mounting	10-180-1
Tire Pressure	10-180-1
Wheel Nuts	10-180-1
TOWING THE LOADER BACKHOE	10-50-1
Procedure	10-50-1
TRANSPORTING THE LOADER BACKHOE	10-40-1
Procedure	10-40-1

Dealer Copy -- Not for Resale

LIFTING AND BLOCKING THE LOADER BACKHOE

Procedure



Instructions are necessary before operating or servicing machine. Read and understand the Operation & Maintenance Manual, Handbook and signs (decals) on machine. Follow warnings and instructions in the manuals when making repairs, adjustments or servicing. Check for correct function after adjustments, repairs or service. Untrained operators and failure to follow instructions can cause injury or death.

W-2003-0199

Figure 10-10-1

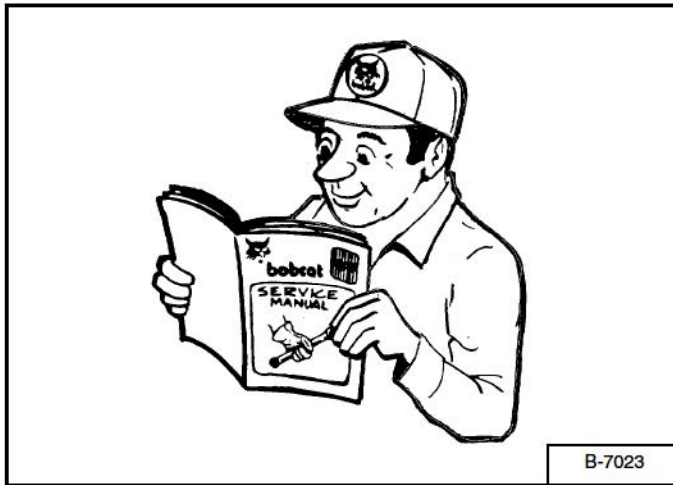

Read the removal and installation, disassembly and assembly, etc., completely to become familiar with the procedure before beginning [Figure 10-10-1].

Always park the loader backhoe on a level surface.

Stop the engine, and engage the parking brake.



Put jackstands under the front and rear axle before running the engine for service. Failure to use jackstands can allow the machine to fall or move and cause injury or death.

W-2461-0303

Figure 10-10-2

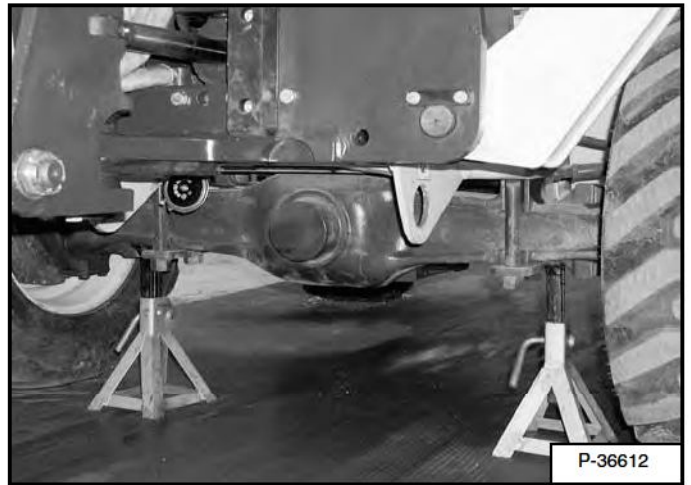

Lift the rear of the loader backhoe and install jackstands [Figure 10-10-2].

Figure 10-10-3



NOTE: Loader lift arms are raised for photo clarity.

Lift the front of the loader backhoe and put jackstands under the axle [Figure 10-10-3].

Note: Make sure the jackstands do not touch the tires.

Dealer Copy -- Not for Resale

APPROVED LIFT ARM SUPPORT DEVICE

Maintenance and service work can be done with the lift arms lowered. If the lift arms are raised, use the following procedures to install and remove the approved lift arm support device:



Never work on a machine with the lift arms up unless the lift arms are secured by an approved lift arm support device. Failure to use an approved lift arm support device can allow the lift arms or attachment to fall and cause injury or death.

W-2059-0598



Service lift arm support device if damaged or if parts are missing. Using a damaged lift arm support or with missing parts can cause lift arms to drop causing injury or death.

W-2271-1197

Installing The Approved Lift Arm Support Device

Remove the bucket or attachment from the loader.

Figure 10-20-1

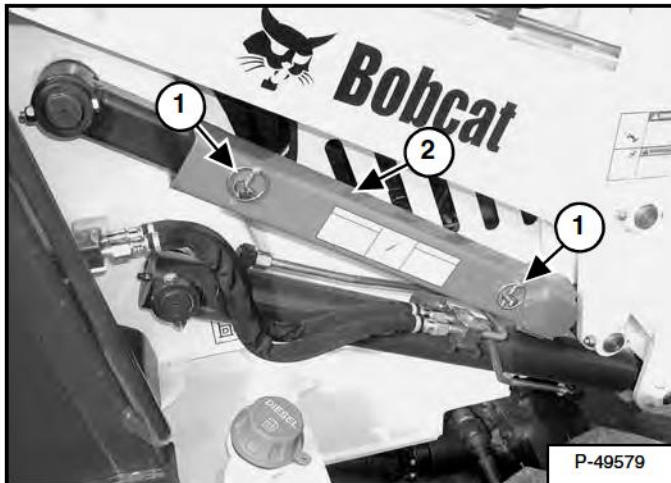

Remove the two pins (Item 1) and remove the approved lift arm support device (Item 2) [Figure 10-20-1] from the storage position.

Start the engine and raise the lift arms fully. Stop the engine.

Figure 10-20-2

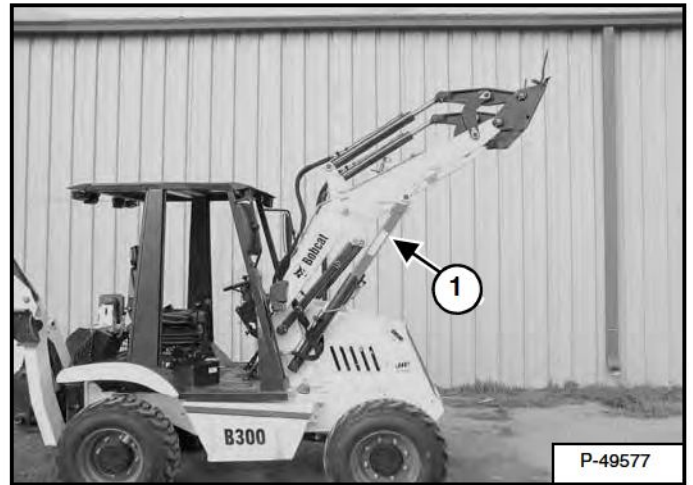

Install the approved lift arm support device (Item 1) [Figure 10-20-2] over the lift cylinder rod.

Figure 10-20-3

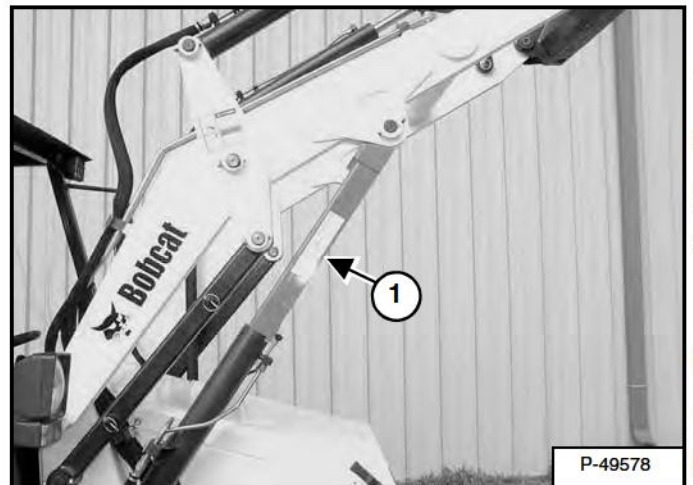

Lower the lift arms slowly until the approved lift support device (Item 1) [Figure 10-20-3] is held securely.

Dealer Copy -- Not for Resale

APPROVED LIFT ARM SUPPORT DEVICE (CONT'D)

Removing The Approved Lift Arm Support Device

Figure 10-20-4

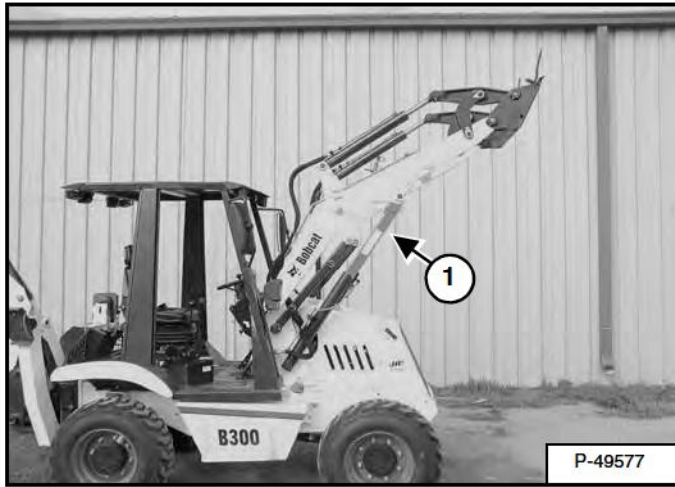

Start the engine and raise the lift arms approximately 2 inches (51 mm). Stop the engine.

Remove the approved lift arm support device (Item 1) [Figure 10-20-4].

Lower the lift arms fully.

Figure 10-20-5

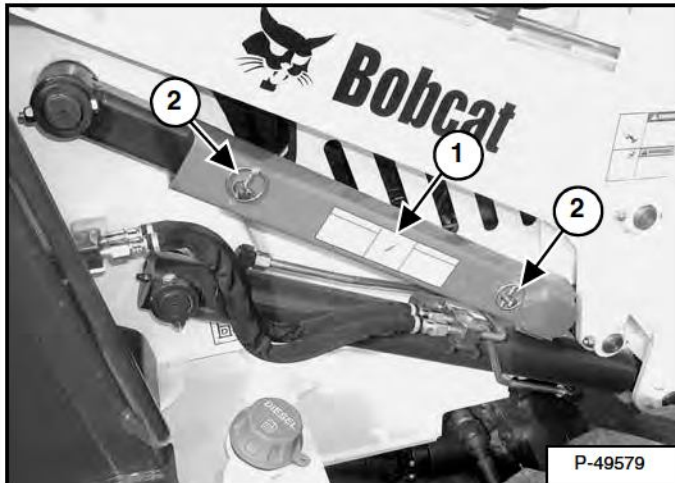

Put the approved lift arm support (Item 1) in the storage position. Install the two retaining pins (Item 2) [Figure 10-20-5].

ENGINE COVER

Figure 10-30-1

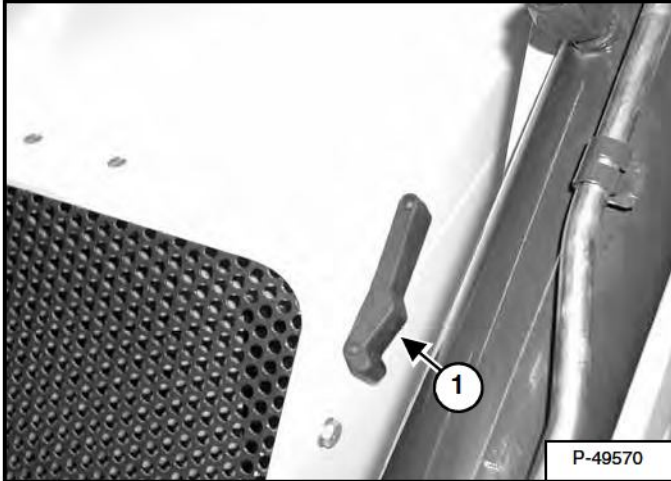

Open the latch (Item 1) [Figure 10-30-1] on each side of the engine cover.

Raise the engine cover.

Figure 10-30-2

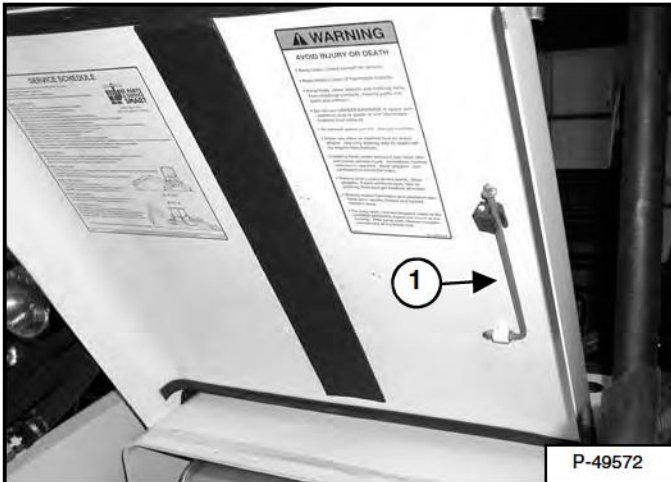

Remove the engine cover support rod (Item 1) [Figure 10-30-2] from the storage position.

Figure 10-30-3

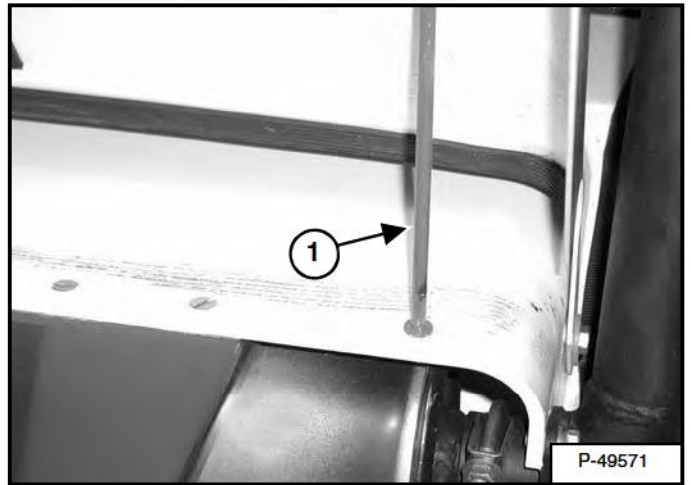

Place the end of the support rod (Item 1) [Figure 10-30-3] into the hole located on the hood to hold the engine cover open.

TRANSPORTING THE LOADER BACKHOE

Procedure



Adequately designed ramps of sufficient strength are needed to support the weight of the machine when loading onto a transport vehicle. Wood ramps can break and cause personal injury.

W-2058-0494

Be sure the transport and towing vehicles are of adequate size and capacity. (See Loader Backhoe Dimensions on Page SPEC-10-1 for weight of the loader backhoe.)

Figure 10-40-1

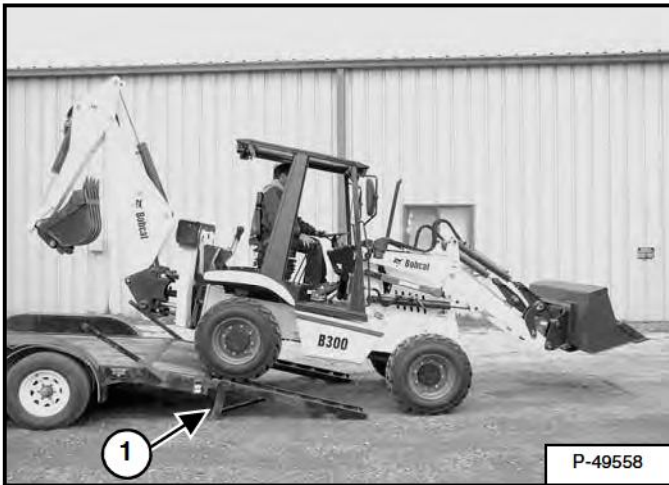

The rear of the trailer must be blocked or supported (Item 1) [Figure 10-40-1] when loading or unloading the loader backhoe to prevent the front end of the trailer from raising up.

Use the following procedure to secure the loader backhoe to the transport vehicle to prevent the loader backhoe from moving during sudden stops or when going up or down slopes.

- Lower the loader bucket.
- Lower the backhoe bucket.
- Place the Travel Direction Control Lever in neutral.
- Engage the parking brake.
- Stop the engine.

TRANSPORTING THE LOADER BACKHOE (CONT'D)

Figure 10-40-2



- Install chains at the rear of the machine [Figure 10-40-2], front of the machine [Figure 10-40-3] and at the backhoe [Figure 10-40-4].
- Fasten each end of the chain to the transport vehicle.

NOTE: For height restrictions the boom lock pin and swing lock pin must not be engaged when transporting the loader backhoe on a trailer. The backhoe boom must be lowered onto the trailer bed and chained

Figure 10-40-3

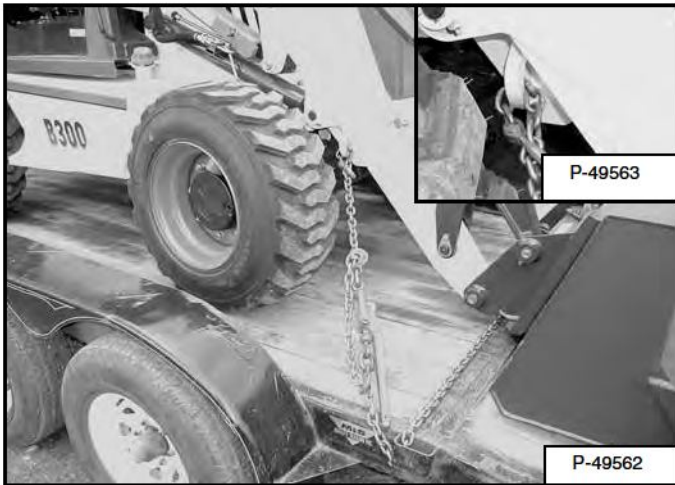
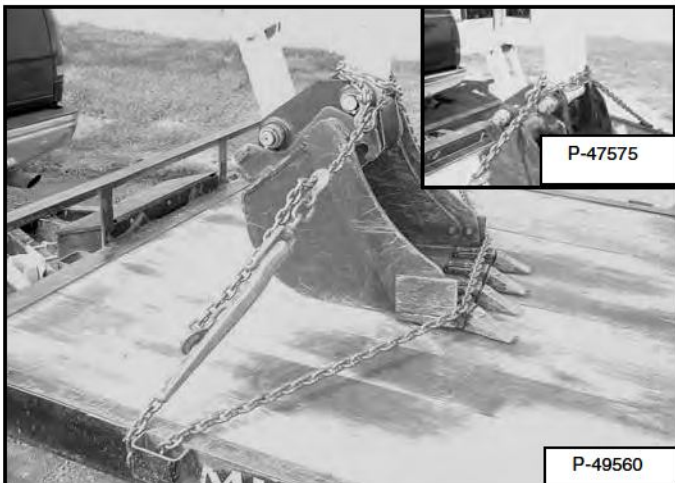

Figure 10-40-4



TOWING THE LOADER BACKHOE

Procedure

Place blocks in front and behind rear wheels.

Figure 10-50-1

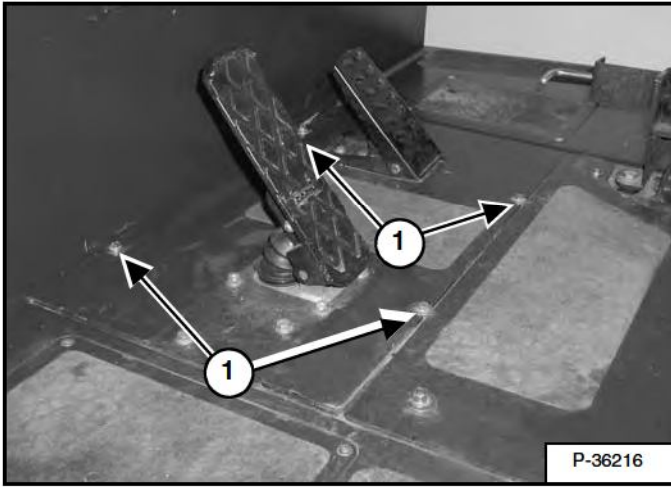

Remove the four mounting bolts (Item 1) [Figure 10-50-1].

Figure 10-50-2

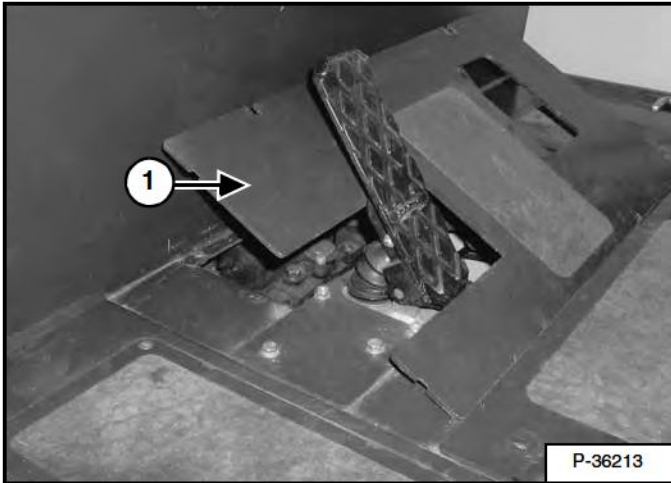

Remove the cover (Item 1) [Figure 10-50-2].

Figure 10-50-3

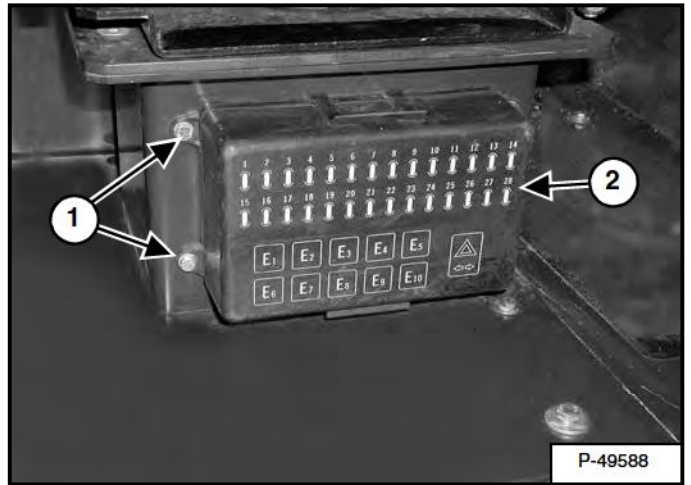

Remove the four bolts (Item 1) and remove the fuse box assembly (Item 2) [Figure 10-50-3].

Figure 10-50-4

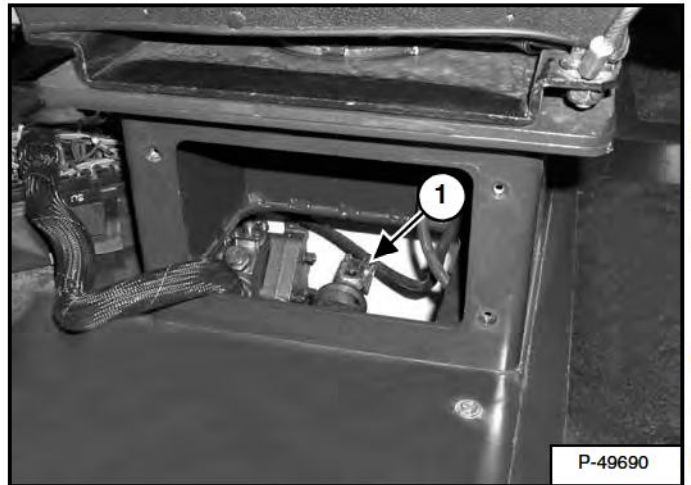

Locate the brake cylinder linkage (Item 1) [Figure 10-50-4] inside the seat housing above the rear axle.

Dealer Copy -- Not for Resale

TOWING THE LOADER BACKHOE (CONT'D)

Procedure (Cont'd)

Figure 10-50-5

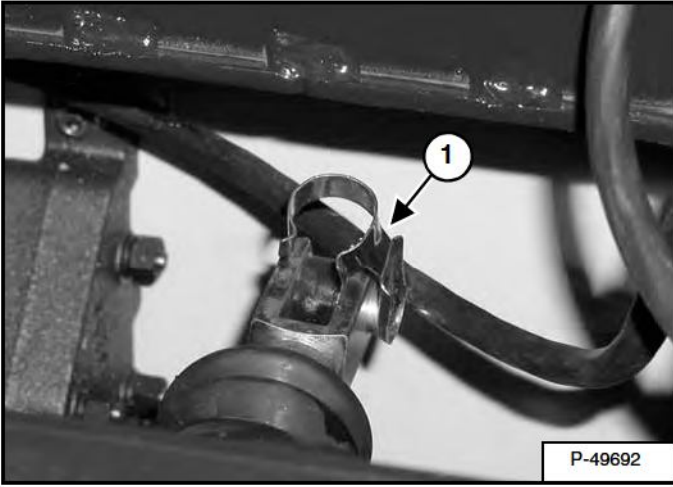

Rotate the pin (Item 1) [Figure 10-50-5] up and remove from brake cylinder.

Figure 10-50-6

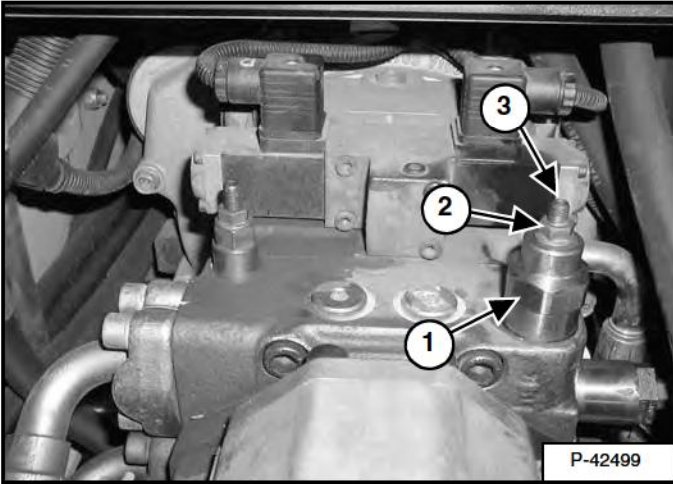

Locate the tow valve (Item 1) [Figure 10-50-6] on the top of the hydrostatic pump.

Loosen the nut (Item 2) [Figure 10-50-6].

Turn the screw (Item 3) [Figure 10-50-6] out exactly four turns.

Figure 10-50-7

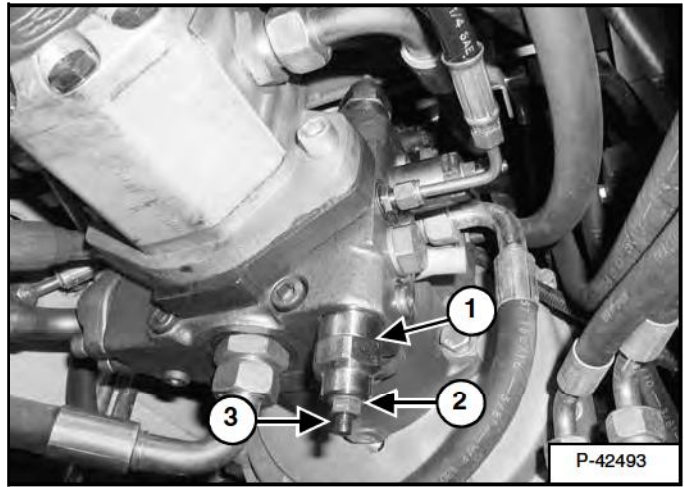

Locate the tow valve (Item 1) [Figure 10-50-7] on the bottom side of the hydrostatic pump.

Loosen the nut (Item 2) [Figure 10-50-7].

Turn the screw (Item 3) [Figure 10-50-7] out exactly four turns.

To prevent damage to the loader backhoe hydrostatic system, the loader backhoe must be towed only a short distance at a low speed. (Example: Moving the loader backhoe onto a transport vehicle.)

The towing chain (or cable) must be rated at 1-1/2 times the weight of the loader. (See Loader Backhoe Dimensions on Page SPEC-10-1.)

NOTE: Be sure to retighten the tow valves and connect the parking brake linkage before operating the loader backhoe after towing.

AXLE TOE-IN

Procedure

Raise the lift arms and install the approved lift arm support device. (See Installing The Approved Lift Arm Support Device on Page 10-20-1.)



Never work on a machine with the lift arms up unless the lift arms are secured by an approved lift arm support device. Failure to use an approved lift arm support device can allow the lift arms or attachment to fall and cause injury or death.

W-2059-0598

Figure 10-60-1

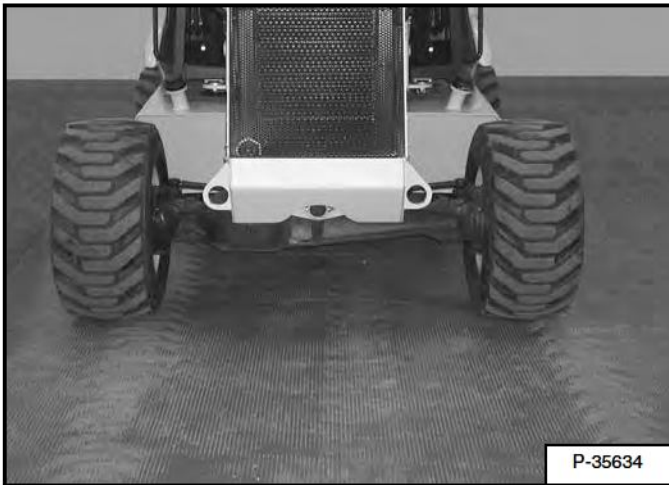

The front axle and rear axle toe-in adjustment procedure are the same. The front axle toe-in procedure is shown.

Turn the steering wheel until the front wheels are positioned as shown [Figure 10-60-1].

Figure 10-60-2



Measure the exposed part of the cylinder rod on each side of the steering cylinder housing making sure they are the same length [Figure 10-60-2].

Figure 10-60-3

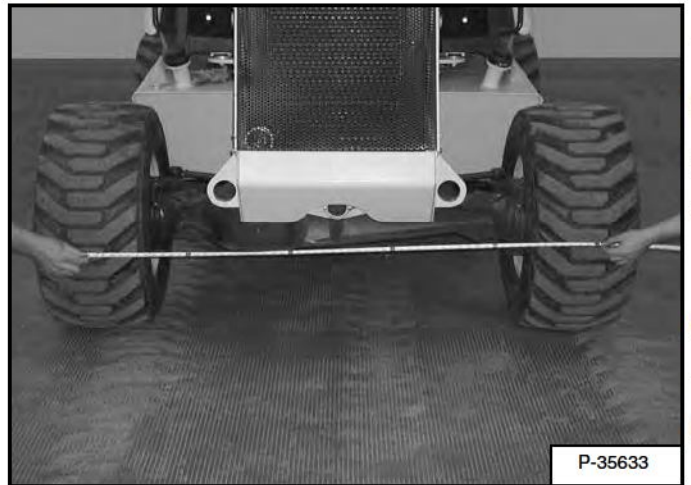

Measure the distance between the centerlines on the front of the tires and compare it to the measurement taken from the centerlines on the backside of the tires [Figure 10-60-3]. The measurement must be equal.

Dealer Copy -- Not for Resale

AXLE TOE-IN (CONT'D)

Procedure (Cont'd)

Figure 10-60-4

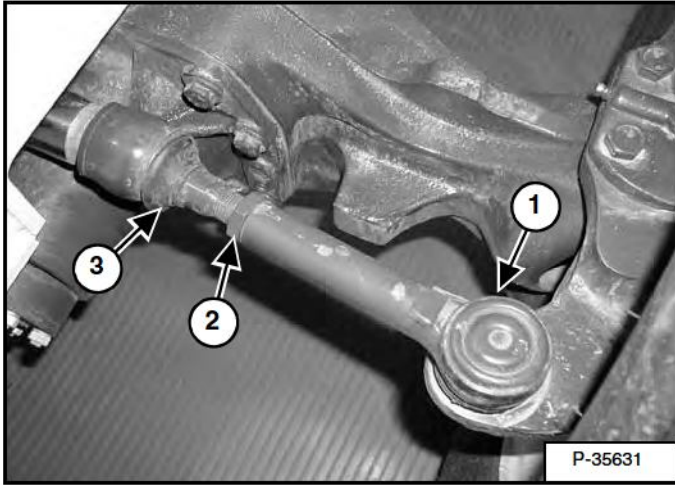

If measurement is not the same, adjust both tie rod ends (Item 1) by loosening both jam nuts (Item 2), loosen or tighten the track rod (Item 3) [Figure 10-60-4] of both tie rods until the measurement is the same.

SERVICE SCHEDULE

Chart

Maintenance work must be done at regular intervals. Failure to do so will result in excessive wear and early failures. The service schedule is a guide for correct maintenance of the Bobcat Loader Backhoe.

 <b style="font-size: 24pt; margin-left: 10px;">WARNING	<p>Instructions are necessary before operating or servicing machine. Read and understand the Operation & Maintenance Manual, Operator's Handbook and signs (decals) on machine. Follow warnings and instructions in the manuals when making repairs, adjustments or servicing. Check for correct function after adjustments, repairs or service. Untrained operators and failure to follow instructions can cause injury or death.</p> <p style="text-align: right; font-size: 10pt;">W-2003-0199</p>
--	--

SERVICE SCHEDULE		HOURS					
		8-10	50	100	250	500	1000
ITEM	SERVICE REQUIRED						
Engine Oil	Check the oil level and add as needed.						
Hydraulic Fluid	Check fluid level and add as needed.						
Fuel Filter	Remove trapped water.						
Engine Air System	Check for leaks and damaged components.						
Engine Cooling System	Clean debris from oil cooler, radiator & grill. Check coolant level.						
Lift Arms, Cyl., Bob-Tach Pivot Pins, Wedges, Etc.	Lubricate all machinery pivots with multi-purpose lithium based grease. See illustrations.						
X-Change™ System	Check for loose or damaged parts. Torque X-Change™ bolts to 130 ft.-lb. (177 N•m)						
Tires	Check for correct size, damaged tires and correct air pressure.						
Seat Belt, Seat Belt Retractors	Check the condition of seat belt. Clean or replace seat belt retractors as needed.						
Mirrors	Clean and adjust as necessary						
Steering valve	Check and adjust wheel alignment as required.						
Safety Signs and Safety Treads	Check for damaged signs (decals) and safety treads. Replace any signs or safety treads that are damaged or worn.						
Operator Canopy/Cab (ROPS/FOPS)	Check the fastening bolts, washers and nuts. Check the condition of the canopy/cab.						
Indicators and Lights	Check for correct operation of all indicators and lights.						
Parking Brake	Check operation.						
PRESS TO DRIVE System	Check for proper function.						
Backup Alarm	Check operation. Repair or replace as required.						
Hydraulic Fluid, Hoses and Tubelines	Check fluid level & add as needed. Check for damage and leaks. Repair or replace as needed.						
Front & Rear Differential	Check oil level. Add oil as needed.						
Wheel Nuts	Check for loose wheel nuts and tighten to 140 ft.-lb. (190 N•m) torque.	☐					
Battery	Check cables, connections and electrolyte level. Add distilled water as needed.						
Spark Arrestor Muffler	Empty the spark chamber (if equipped).						
Alternator/Fan Belt	Check tension and adjust as needed.		*				
Fuel Filter	Replace filter element.						
Steering King Pins	Lubricate with multi-purpose lithium based grease.						
Engine Oil and Filter	Replace oil & filter. Use CD or better grade oil and Bobcat filter.		†				
Hydraulic Oil Filter	Replace the filter element.		●				
Engine Air Filter	Replace the air filter element.		◇				
Engine Cooling System	Flush the cooling system and add new coolant.						
Hydraulic Reservoir	Replace the fluid and the filter.						
Differential Oil	Replace the differential oil.						

- ☐ Check wheel nut torque every 8 hours for the first 24 hours.
- * Inspect the new belt after first 50 hours.
- Replace hydraulic filter element after the first 50 hours and every 500 hours thereafter.
- † First oil and filter change must occur at 50 hours: 250 hours thereafter.
- ◇ Replace the engine air filter element after the first 50 hours and every 500 hours thereafter.
- Or every 12 months.

Dealer Copy -- Not for Resale

AIR CLEANER SERVICE

Replacing The Filter

See SERVICE SCHEDULE on Page 10-70-1 for the correct service interval.

Raise the loader lift arms and install the Approved Lift Arm Support Device. (See Installing The Approved Lift Arm Support Device on Page 10-20-1).



Never work on a machine with the lift arms up unless the lift arms are secured by an approved lift arm support device. Failure to use an approved lift arm support device can allow the lift arms or attachment to fall and cause injury or death.

W-2059-0598

Open the engine cover. (See ENGINE COVER on Page 10-30-1.)

Figure 10-80-1

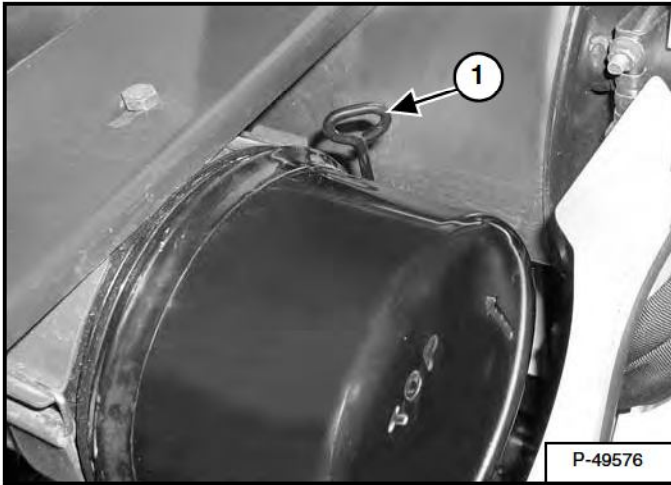

Loosen the air cleaner cover clamp (Item 1) [Figure 10-80-1].

Figure 10-80-2

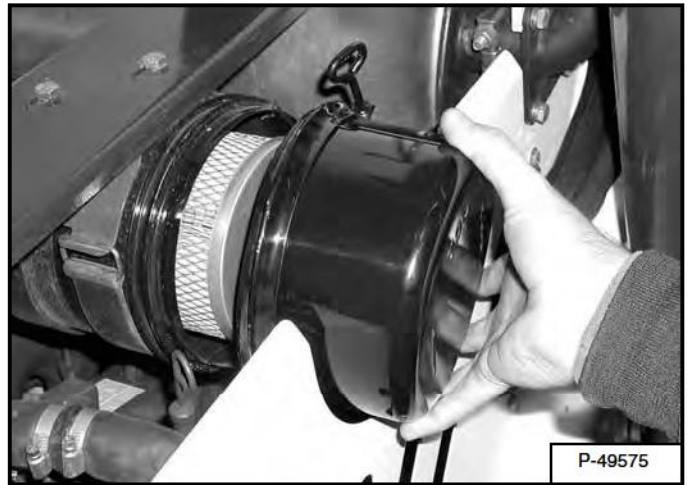

Remove the air cleaner cover [Figure 10-80-2].

Figure 10-80-3

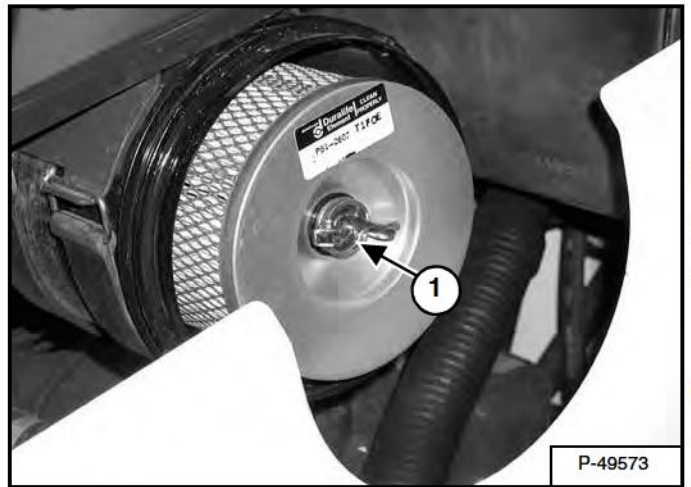

Loosen and remove the screw (Item 1) [Figure 10-80-3].

Dealer Copy -- Not for Resale



Suggest:

If the above button click is invalid.

Please download this document

first, and then click the above link

to download the complete manual.

Thank you so much for reading

AIR CLEANER SERVICE (CONT'D)

Replacing The Filter (Cont'd)

Figure 10-80-4

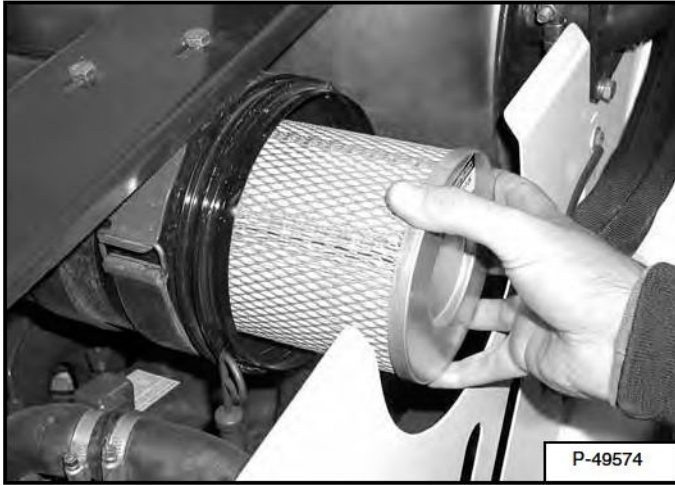

Remove the filter element [Figure 10-80-4].

NOTE: Make sure all sealing surfaces are free of dirt and debris.

Install a new element into the housing and tighten screw (Item 1) [Figure 10-80-3].

Install the air cleaner cover [Figure 10-80-2].

Tighten the air cleaner cover clamp (Item 1) [Figure 10-80-1].

<https://www.ebooklibonline.com>

Hello dear friend!

Thank you very much for reading.

Enter the link into your browser.

The full manual is available for immediate download.

<https://www.ebooklibonline.com>