

B250



Bobcat®

Service Manual

(S/N 570311001 & Above)

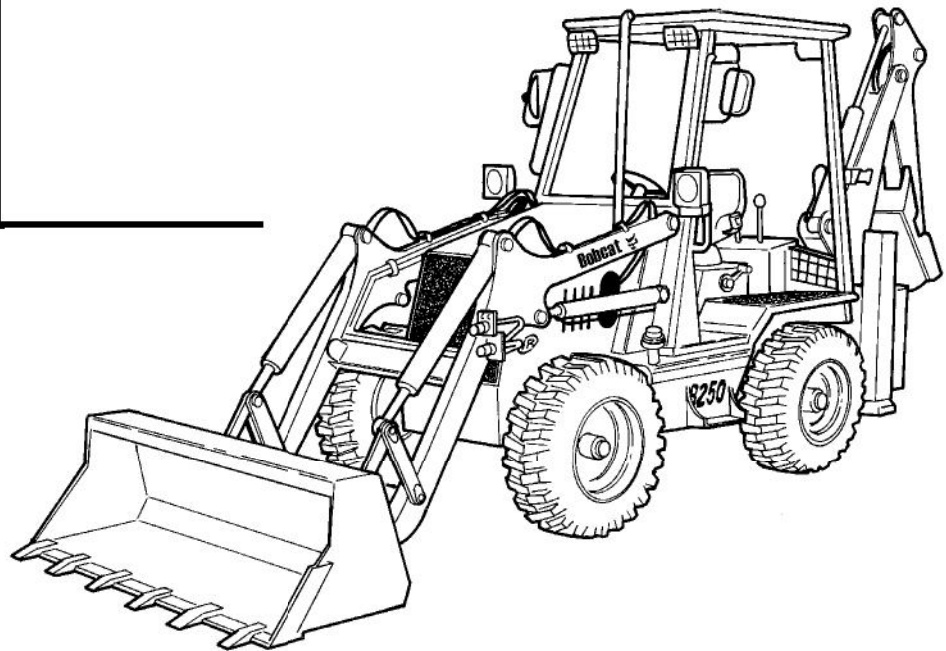

Doosan purchased Bobcat Company from Ingersoll-Rand Company in 2007. Any reference to Ingersoll-Rand Company or use of trademarks, service marks, logos, or other proprietary identifying marks belonging to Ingersoll-Rand Company in this manual is historical or nominative in nature, and is not meant to suggest a current affiliation between Ingersoll-Rand Company and Bobcat Company or the products of either.

MAINTENANCE SAFETY



WARNING

Instructions are necessary before operating or servicing machine. Read and understand the Operation & Maintenance Manual, Operator's Handbook and signs (decals) on machine. Follow warnings and instructions in the manuals when making repairs, adjustments or servicing. Check for correct function after adjustments, repairs or service. Untrained operators and failure to follow instructions can cause injury or death.

W-2003-0903



Safety Alert Symbol: This symbol with a warning statement, means: "Warning, be alert! Your safety is involved!" Carefully read the message that follows.

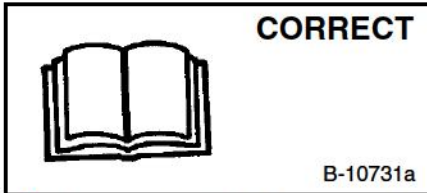

- Never service the Bobcat Loader Backhoe without instructions.

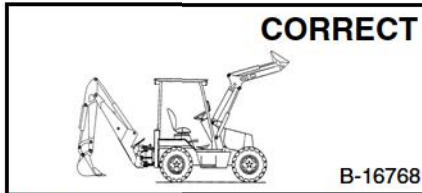

- Always use an approved lift arm support device when servicing the loader backhoe with the lift arms raised. Replace the lift arm support device if damaged or missing.
- Disconnecting or loosening any hydraulic tubeline, hose, fitting component, or part failure can cause lift arms or backhoe boom to drop.

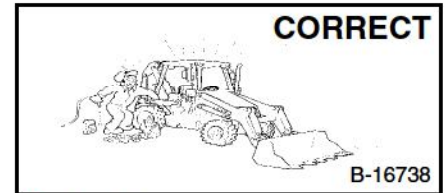

- Cleaning and maintenance are required daily.
- NEVER modify equipment or add attachments not approved by Bobcat.

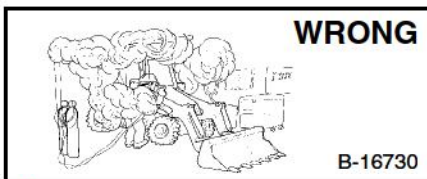

- Have good ventilation when welding or grinding painted parts.
- Wear dust mask when grinding painted parts. Toxic dust and gas can be produced.

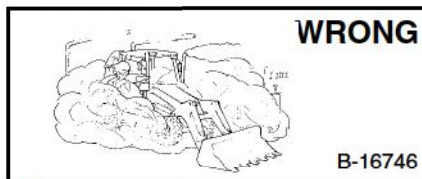

- Vent exhaust to outside when engine must be run for service.
- Exhaust system must be tightly sealed. Exhaust Fumes can kill without warning.



- Never work on loader backhoe with lift arms raised unless supported by an approved lift arm support device.
- Always lower the backhoe bucket to the ground before doing any maintenance.

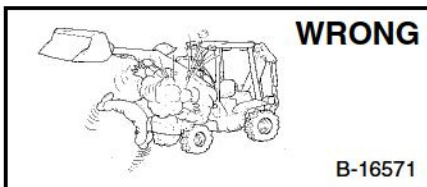

- Stop, cool and clean engine of flammable materials before checking fluids.
- Never service or adjust machine with the engine running unless instructed to do so in the manual.
- Avoid contact with leaking hydraulic fluid or diesel fuel under pressure. It can penetrate the skin or eyes.
- Never fill fuel tank with engine running, while smoking or when near open flame.

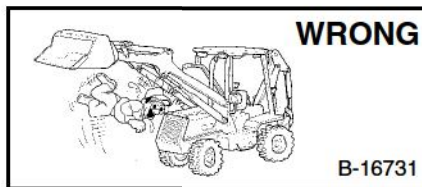

- Keep body, jewelry and clothing away from moving parts, electrical contact, hot parts and exhaust.
- Wear eye protection to guard from battery acid, compressed springs, fluids under pressure and flying debris when engines are running or tools are used.
- Use eye protection approved for type of welding.
- Keep engine cover closed except for service. Close and latch engine cover before operating the loader backhoe.



- Lead-acid batteries produce flammable and explosive gases.
- Keep arcs, sparks, flames and lighted tobacco away from batteries.
- Batteries contain acid which burns eyes or skin on contact. Wear protective clothing. If acid contacts body, flush well with water. For eye contact flush well and get immediate medical attention.

Maintenance procedures which are given in the Operation & Maintenance Manual can be performed by the owner/operator without any specific technical training. Maintenance procedures which are not in the Operation & Maintenance Manual must be performed **ONLY BY QUALIFIED BOBCAT SERVICE PERSONNEL**. Always use genuine Bobcat replacement parts.

MSW16-0805

Dealer Copy -- Not for Resale

ALPHABETICAL INDEX

AIR CLEANER	70-01	HEATER FAN	80-01
AIR CLEANER SERVICE	10-01	HEATER UNIT	80-01
ALTERNATOR	60-01	HYDRAULIC FILTER HOUSING	20-01
ALTERNATOR BELT	10-01	HYDRAULIC FLUID RESERVOIR	20-01
ARM CYLINDER	20-01	HYDRAULIC SYSTEM INFORMATION	20-01
ARM	50-01	HYDRAULIC/HYDROSTATIC FLUID SPECIFICATIONS	SPEC-01
AXLE AND DIFFERENTIAL (FRONT)	40-01	HYDRAULIC/HYDROSTATIC SYSTEM	10-01
AXLE AND DIFFERENTIAL (REAR)	40-01	HYDROSTATIC DRIVE MOTOR	30-01
AXLE TOE-IN	10-01	HYDROSTATIC PUMP	30-01
		HYDROSTATIC SYSTEM INFORMATION	30-01
		HYDROSTATIC TESTING	30-01
BACKHOE BOOM LOCK	10-01	INSTRUMENT PANEL	60-01
BACKHOE CONTROL VALVE	20-01		
BATTERY	60-01	LOADER BACKHOE SPECIFICATIONS	SPEC-01
BOB-TACH	50-01	LOADER BACKHOE TORQUE	SPEC-01
BOB-TACH HAND LEVER	10-01	LOADER CONTROL VALVE	20-01
BOOM	50-01	LIFT ARMS	50-01
BOOM CYLINDER	20-01	LIFT ARM SUPPORT DEVICE	10-01
BRAKE CALIPER	40-01	LIFT CYLINDER	20-01
BUCKET	50-01	LIFTING AND BLOCKING THE LOADER BACKHOE	10-01
BUCKET CYLINDER	20-01	LUBRICATING THE LOADER BACKHOE	10-01
CAB DOOR	50-01	MAIN RELIEF VALVE	20-01
CAB LIGHTS	60-01	MUFFLER	70-01
COMPONENTS	80-01		
CONVERSIONS	SPEC-01	OIL COOLER	30-01
		OPERATOR CAB	50-01
		OPERATOR SEAT	50-01
DRIVESHAFT	40-01		
DROP BOX	40-01	PARKING BRAKE	40-01
		PORT RELIEF VALVE (BACKHOE CONTROL VALVE)	20-01
ELECTRICAL SYSTEM INFORMATION	60-01	PORT RELIEF VALVE (LOADER CONTROL VALVE)	20-01
ENCLOSED CAB	50-01		
ENGINE	70-01	RADIATOR	70-01
ENGINE COMPONENTS AND TESTING	70-01	REAR AXLE	10-01, 40-01
ENGINE COOLING SYSTEM	10-01	REAR WINDOW	50-01
ENGINE COVER	10-01, 50-01	REAR WIPER	60-01
ENGINE LUBRICATION SYSTEM	10-01	RECONDITIONING THE ENGINE	70-01
ENGINE SIDE COVERS	50-01	RUBBER DRIVE COUPLER	70-01
ENGINE SPECIFICATIONS	SPEC-01		
ENGINE SPEED CONTROL	70-01	SERVICE SCHEDULE	10-01
		SIDE SHIFT LOCK CYLINDER	20-01
FENDER	50-01	STABILIZER FRAME	50-01
FLOOR PANELS	50-01	STABILIZER CYLINDER	20-01
FLYWHEEL	70-01	STEERING ANGLE ADJUSTMENT (FRONT AXLE)	40-01
FLYWHEEL HOUSING	70-01	STEERING ANGLE ADJUSTMENT (REAR AXLE)	40-01
FRONT AXLE	10-01, 40-01	STEERING CYLINDER (FRONT)	20-01
FRONT AXLE PIVOT FRAME	50-01	STEERING CYLINDER (REAR)	20-01
FRONT LIGHTS	60-01	STEERING PUMP	20-01
FRONT WIPER	60-01	STEERING VALVE	20-01
FUEL LEVEL SENDER	60-01		
FUEL SYSTEM	10-01		
FUEL TANK	50-01		
GEAR PUMP	20-01		
GRILL	50-01		
GRILL FRAME	50-01		

ALPHABETICAL INDEX (CONT'D)

STARTER 60-01
SWING CYLINDER 20-01
SWING FRAME 50-01

TILT CYLINDER 20-01
TIRE MAINTENANCE 10-01
TORQUE SPECIFICATIONS
 FOR BOLTS SPEC-01
TOWING THE LOADER BACKHOE 10-01
TRANSPORTING THE LOADER BACKHOE 10-01
TRAVEL PEDAL 20-01
TROUBLESHOOTING 70-01
TURBOCHARGER 70-01
TURN INDICATOR LIGHTS (FRONT) 60-01
TURN INDICATOR LIGHTS (REAR) 60-01

X-CHANGE™ 50-01

<https://www.ebooklibonline.com>

Hello dear friend!

Thank you very much for reading.

Enter the link into your browser.

The full manual is available for immediate download.

<https://www.ebooklibonline.com>

CONTENTS

FOREWORD.....	..II
SAFETY INSTRUCTIONS	V
SERIAL NUMBER LOCATION	IX
DELIVERY REPORT.....	IX
BOBCAT LOADER IDENTIFICATION.....	X
SAFETY & MAINTENANCE	10-01
HYDRAULIC SYSTEM	20-01
HYDROSTATIC SYSTEM.....	30-01
DRIVE SYSTEM	40-01
MAIN FRAME	50-01
ELECTRICAL SYSTEM AND ANALYSIS	60-01
ENGINE SERVICE	70-01
HEATER	80-01
SPECIFICATIONS.....	SPEC-01

**SAFETY &
MAINTENANCE**

**HYDRAULIC
SYSTEM**

**HYDROSTATIC
SYSTEM**

**DRIVE
SYSTEM**

MAIN FRAME

**ELECTRICAL
SYSTEM &
ANALYSIS**

**ENGINE
SERVICE**

HEATER

SPECIFICATIONS

FOREWORD

This manual is for the Bobcat loader mechanic. It provides necessary servicing and adjustment procedures for the Bobcat loader and its component parts and systems. Refer to the Operation & Maintenance Manual for operating instructions, Starting procedure, daily checks, etc.

A general inspection of the following items must be made after the loader has had service or repair:

1. Check that ROPS mounting hardware is tightened and is Bobcat approved.



2. The seat belt must be correctly installed, functional and in good condition.

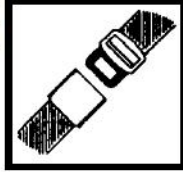

3. Check lift arm support device, replace if damaged.

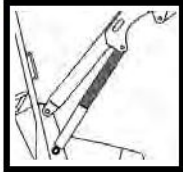

4. Machine signs must be legible and in the correct location.



5. Foot pedal must return to neutral.

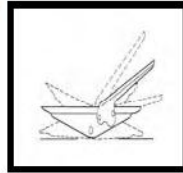

6. Check for correct function of the work lights



7. The parking brake must function correctly.



8. Enclosure door latches must open and close freely.

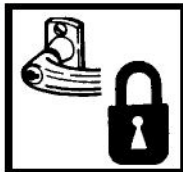

9. Bob-Tach wedges and linkages must function correctly and be in good condition.

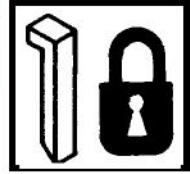

10. Safety treads must be in good condition.



11. Check for correct function of indicator lamps (Optional on some models).

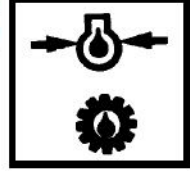

12. Check hydraulic fluid level, engine oil level and fuel supply.



13. Inspect for fuel, oil or hydraulic fluid leaks.



14. Lubricate the loader backhoe.



15. Check the condition of the battery and cables.

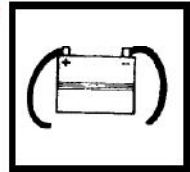

16. Inspect the air cleaner for damage or leaks. Check the condition of the element.

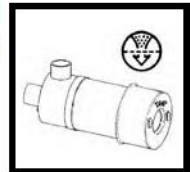

Dealer Copy -- Not for Resale

17. Check the electrical charging system.

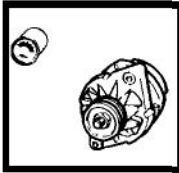

20. Operate the loader and check all functions.



18. Check tires for wear and pressure.

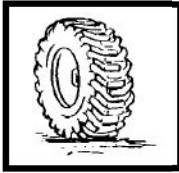

21. Check for any field modification not completed.



19. Inspect for loosen or broken parts or connections.



22. Recommend to the owner that all necessary corrections be made before the machine is returned to service.



**CALIFORNIA
PROPOSITION 65 WARNING**
Diesel engine exhaust and some of its constituents are known to the State of California to cause cancer, birth defects and other reproductive harm.

SAFETY INSTRUCTIONS



Safety Alert Symbol

This symbol with a warning statement means: "Warning, be alert! Your safety is involved!" Carefully read the message that follows.



WARNING

Instructions are necessary before operating or servicing machine. Read and understand the Operation & Maintenance Manual, Operator's Handbook and signs (decals) on machine. Follow warnings and instructions in the manuals when making repairs, adjustments or servicing. Check for correct function after adjustments, repairs or service. Untrained operators and failure to follow instructions can cause injury or death.

W-2003-0903



WARNING

Warnings on the machine and in the manuals are for your safety. Failure to obey warnings can cause injury or death.

W-2044-1285

IMPORTANT

This notice identifies procedures which must be followed to avoid damage to the machine.

I-2019-0284

The following publications provide information on the safe use and maintenance of the Bobcat machine and attachments:

- The Delivery Report is used to assure that complete instructions have been given to the new owner and that the machine is in safe operating condition.
- The Operation & Maintenance Manual delivered with the machine or attachment contains operating information as well as routine maintenance and service procedures. It is a part of the machine and can be stored in a container provided on the machine. Replacement Operation & Maintenance Manuals can be ordered from your Bobcat dealer.
- Machine signs (decals) instruct on the safe operation and care of your Bobcat machine or attachment. The signs and their locations are shown in the Operation & Maintenance Manual. Replacement signs are available from your Bobcat dealer.
- An Operator's Handbook fastened to the operator cab. It's brief instructions are convenient to the operator. The handbook is available from your dealer in an English edition or one of many other languages. See your Bobcat dealer for more information on translated versions.
- The AEM Safety Manual delivered with the machine gives general safety information.
- The Service Manual and Parts Manual are available from your dealer for use by mechanics to do shop-type service and repair work.
- The Loader Backhoe Operator Training Course is available through your local dealer or at www.training.bobcat.com or www.bobcat.com. This course is intended to provide rules and practices of correct operation of the Loader Backhoe.
- The Loader Backhoe Safety Video is available from your Bobcat dealer or at www.training.bobcat.com or www.bobcat.com.

Dealer Copy -- Not for Resale

SI LB-0206 SM
SI17-0402

B250 Bobcat Loader Backhoe
Service Manual

SAFETY INSTRUCTIONS (CONT'D)

Fire Prevention

The machine and attachments have components that are at high temperature under normal operating conditions. The primary source of high temperatures is the engine and exhaust system. The electrical system, if damaged or incorrectly maintained, can be a source of arcs or sparks.

Flammable debris (leaves, straw, etc.) must be removed regularly. If flammable debris is allowed to accumulate, it will increase fire hazard. Clean often to avoid this accumulation. Flammable debris in the engine compartment is a potential hazard.

The spark arrestor muffler is designed to control the emission of hot particles from the engine and exhaust system, but the muffler and the exhaust gases are still hot.

- Do not use the machine where exhaust, arcs, sparks or hot components can contact flammable material, explosive dust or gases.
- The operator cab, engine compartment, and engine cooling system must be inspected every day and cleaned if necessary to prevent fire hazard and overheating.
- Check all electrical wiring and connections for damage. Keep the battery terminals clean and tight. Repair or replace any damaged part.
- Check fuel and hydraulic tubes, hoses and fittings for damage and leakage. Never use open flame or bare skin to check for leaks. Tighten or replace any parts that show leakage. Always clean fluid spills. Do not use gasoline or diesel fuel for cleaning parts. Use commercial nonflammable solvents.
- Do not use ether or starting fluids on any engine which has glow plugs. These starting aids can cause explosion and injure you or bystanders.
- Always clean the machine, disconnect the battery, and disconnect the wiring from the controllers before welding. Cover rubber hoses, battery and all other flammable parts. Keep a fire extinguisher near the machine when welding. Have good ventilation when grinding or welding painted parts. Wear a dust mask when grinding painted parts. Toxic dust or gas can be produced.
- Stop the engine and let it cool before adding fuel. **NO SMOKING!**

- Use the procedure in the Operation & Maintenance Manual for connecting the battery and for jump starting.
- Use the procedure in the Operation & Maintenance Manual for cleaning the spark arrestor muffler (if equipped).

Figure 1

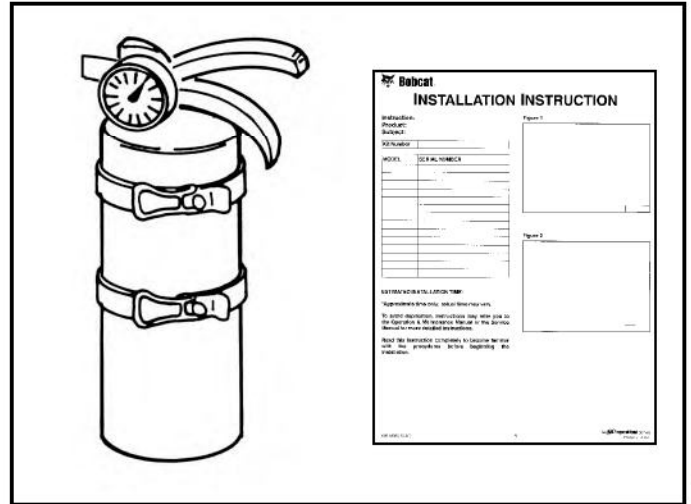

- Know where fire extinguishers and first aid kits are located and how to use them. Fire extinguishers are available from your Bobcat dealer [Figure 1].

Dealer Copy -- Not for Resale

SERIAL NUMBER LOCATION

Always use the serial number of the loader backhoe when requesting service information or when ordering parts. Early or later models (identification made by serial number) may use different parts, or it may be necessary to use a different procedure in doing a specific service operation.

Loader Backhoe Serial Number

Figure 1



The loader backhoe serial number plate is located under the fender in front of the left rear tire [Figure 1].

Explanation of loader Serial Number:

XXXX	XXXXX
Model 1.-Model/ Engine Combination	Model 2.-Production Sequence (Series)

1. The four digit Model/Engine Combination Module number identifies the model number and engine combination.
2. The five digit Production Sequence Number identifies the order which the loader is produced.

Engine Serial Number

Figure 2

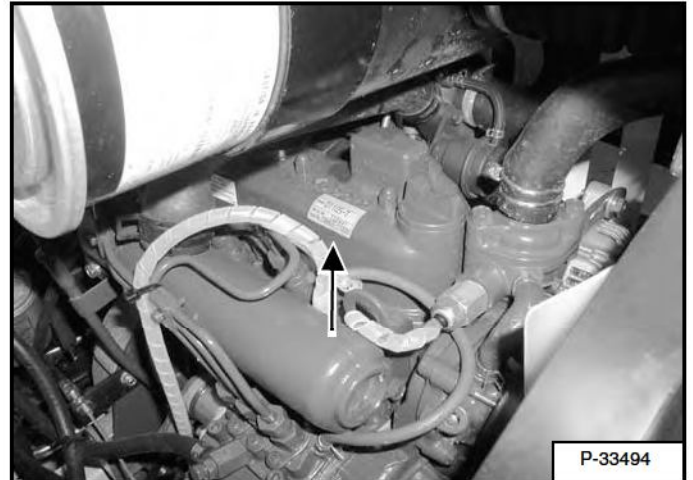

The engine serial number is located on the valve cover at the right side of the engine [Figure 2].

DELIVERY REPORT

Figure 3

The Delivery Report must be filled out by the dealer and signed by the owner or operator when the Bobcat loader backhoe is delivered. An explanation of the form must be given to the owner. Make sure it is filled out completely [Figure 3].

Dealer Copy -- Not for Resale

BOBCAT LOADER IDENTIFICATION

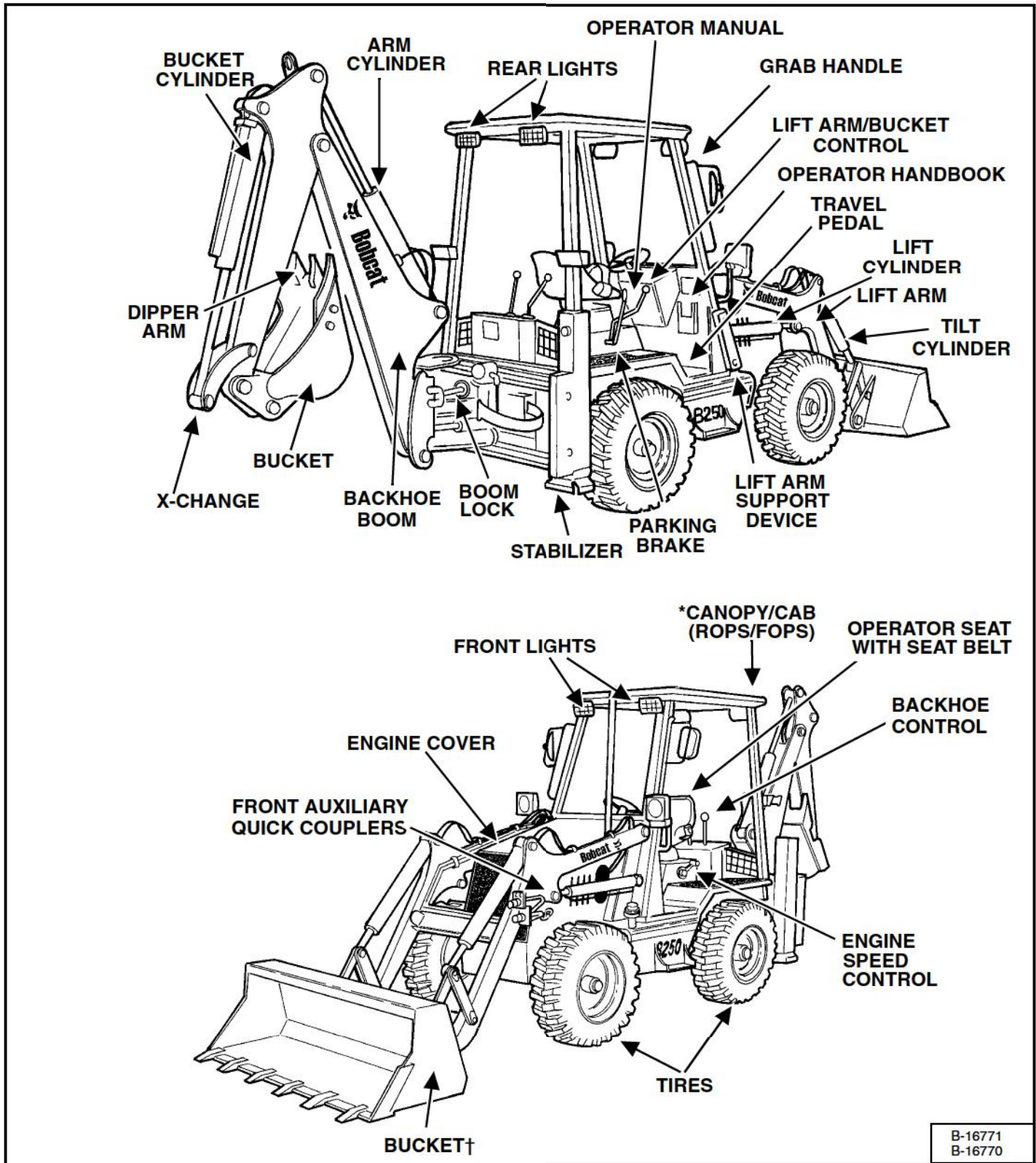

Dealer Copy -- Not for Resale

† BUCKET - Several different buckets and other attachments are available for the Bobcat loader backhoe.

* ROPS, FOPS - Roll Over Protective Structure, Falling Object Protective Structure, per SAE j1040 and ISO 3471 and Falling Object Protective Structure per SAE J1043 and ISO 3449, Level 1.

SAFETY & MAINTENANCE

AIR CLEANER SERVICE 10-80-1
 Replacing Filter Element 10-80-1

ALTERNATOR BELT 10-160-1
 Adjusting The Alternator Belt 10-160-1

AXLE TOE-IN 10-60-1
 Adjustment 10-60-1

BACKHOE BOOM LOCK 10-140-1
 Disengaging The Boom Lock 10-140-1
 Engaging Boom Lock 10-140-2

BOB-TACH HAND LEVER 10-150-1
 Inspection And Maintenance 10-150-1

ENGINE COOLING SYSTEM 10-90-1
 Coolant Replacement 10-90-1

ENGINE COVER 10-30-1

ENGINE LUBRICATION SYSTEM 10-110-1
 Checking Engine Oil 10-110-1
 Oil Chart 10-110-1
 Replacing Oil And Filter 10-110-2

FRONT AXLE 10-130-2
 Checking Oil Level 10-130-2
 Draining Oil 10-130-2

FUEL SYSTEM 10-100-1
 Filling The Fuel Tank 10-100-1
 Fuel Filter 10-100-2
 Fuel Specifications 10-100-1
 Removing Air From The Fuel System 10-100-2

HYDRAULIC/HYDROSTATIC SYSTEM 10-120-1
 Checking And Adding Fluid 10-120-1
 Cleaning The Cooler 10-120-1
 Replacing Hydraulic Fluid 10-120-3
 Replacing Hydraulic/Hydrostatic Filter 10-120-2

LIFT ARM SUPPORT DEVICE 10-20-1
 Installing The Lift Arm Support Device 10-20-1
 Removing The Lift Arm Support Device 10-20-2

LIFTING AND BLOCKING THE LOADER BACKHOE 10-10-1
 Procedure 10-10-1

Continued on next page

Dealer Copy -- Not for Resale

SAFETY & MAINTENANCE (CONT'D)

LUBRICATING THE LOADER BACKHOE	10-170-1
REAR AXLE	10-130-1
Checking Oil Level	10-130-1
Draining Oil	10-130-1
SERVICE SCHEDULE	10-70-1
Chart	10-70-1
TIRE MAINTENANCE	10-180-1
Mounting	10-180-1
Tire Pressure	10-180-1
Wheel Nuts	10-180-1
TOWING THE LOADER BACKHOE	10-50-1
TRANSPORTING THE LOADER BACKHOE	10-40-1
Procedure	10-40-1

Dealer Copy -- Not for Resale

LIFTING AND BLOCKING THE LOADER BACKHOE

Procedure



Instructions are necessary before operating or servicing machine. Read and understand the Operation & Maintenance Manual, Handbook and signs (decals) on machine. Follow warnings and instructions in the manuals when making repairs, adjustments or servicing. Check for correct function after adjustments, repairs or service. Untrained operators and failure to follow instructions can cause injury or death.

W-2003-0199

Figure 10-10-1

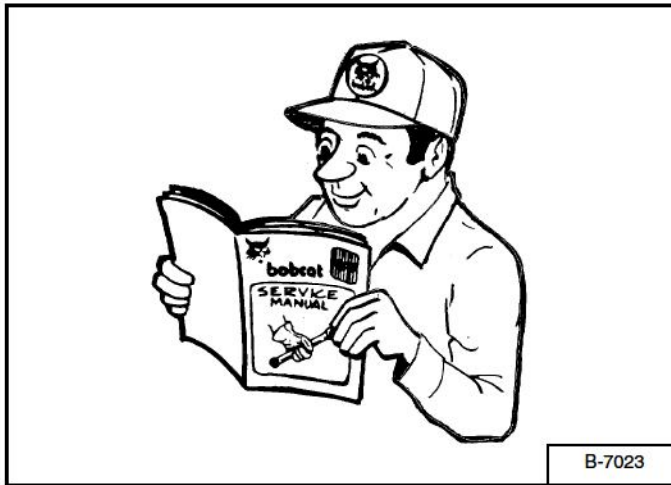

Read the removal and installation, disassembly and assembly, etc., completely to become familiar with the procedure before beginning [Figure 10-10-1].

Always park the loader backhoe on a level surface.

Stop the engine, and engage the parking brake.



Put jackstands under the front and rear axle before running the engine for service. Failure to use jackstands can allow the machine to fall or move and cause injury or death.

W-2461-0303

Figure 10-10-2

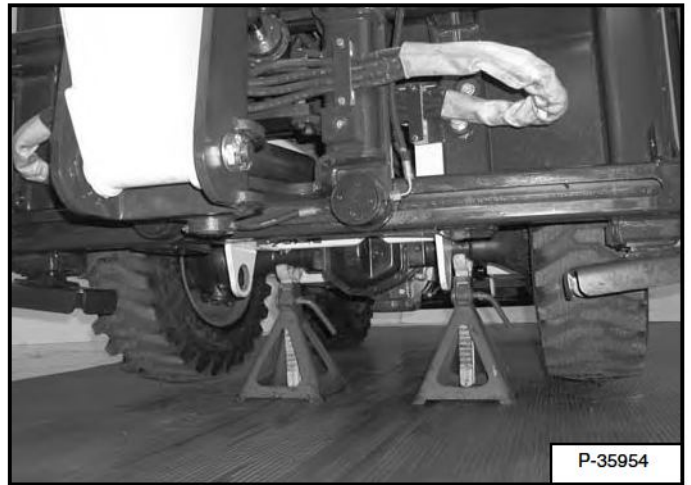

Lift the rear of the loader backhoe and install jackstands [Figure 10-10-2].

Figure 10-10-3



Lift the front of the loader backhoe and put jackstands under the axle [Figure 10-10-3].

Note: Make sure the jackstands do not touch the tires.

Dealer Copy -- Not for Resale

LIFT ARM SUPPORT DEVICE

Maintenance and service work can be done with the lift arms lowered. If the lift arms are raised, use the following procedures to install and remove the approved lift arm support device:

Installing The Lift Arm Support Device



Never work on a machine with the lift arms up unless the lift arms are secured by an approved lift arm support device. Failure to use an approved lift arm support device can allow the lift arms or attachment to fall and cause injury or death.

W-2059-0598



Service lift arm support device if damaged or if parts are missing. Using a damaged lift arm support or with missing parts can cause lift arms to drop causing injury or death.

W-2271-1197

Figure 10-20-1

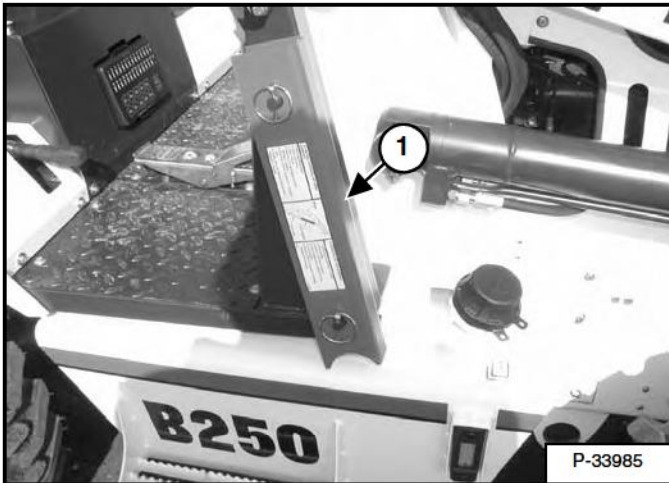

Remove the approved lift arm support device (Item 1) [Figure 10-20-1] from the storage position.

With the operator in the seat, fasten seat belt and engage the parking brake. Start the engine and raise the lift arms. After the lift arms are raised fully, stop the engine.

Figure 10-20-2

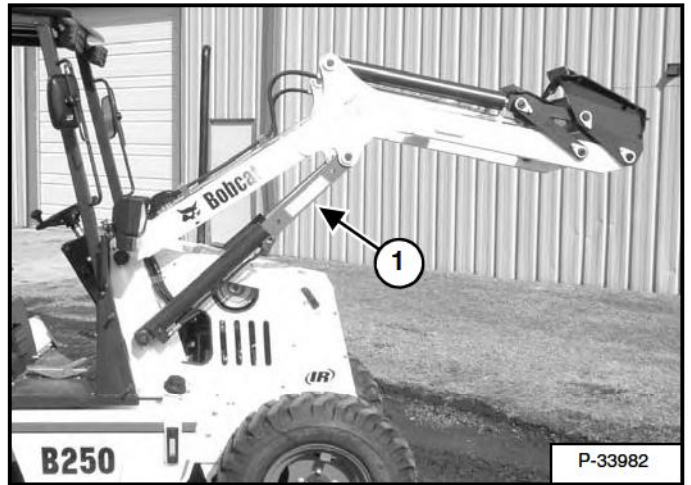

Install the lift arm support device (Item 1) [Figure 10-20-2] over the lift cylinder rod.

Figure 10-20-3



Start the engine and lower the lift arms slowly until the support device is held securely [Figure 10-20-3].

Stop the engine.

Dealer Copy -- Not for Resale

LIFT ARM SUPPORT DEVICE (CONT'D)

Removing The Lift Arm Support Device

Figure 10-20-4

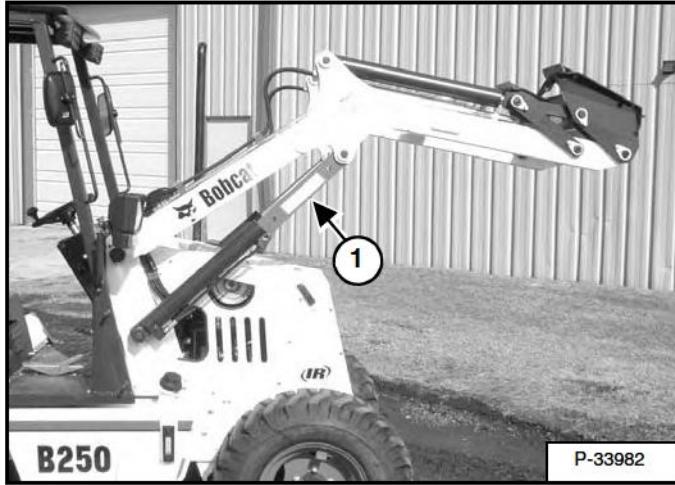

With the operator in the seat, seat belt fastened and the parking brake engaged, start the engine and raise the lift arms. After the lift arms are raised fully, stop the engine.

Remove the approved lift arm support device (Item 1) [Figure 10-20-4].

Start the engine and lower the lift arms fully.

Figure 10-20-5

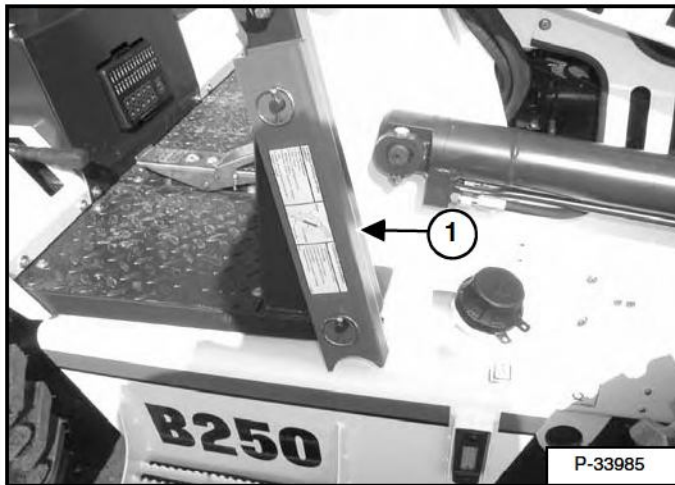

Put the lift arm support (Item 1) [Figure 10-20-5] in the storage position.

ENGINE COVER

Figure 10-30-1

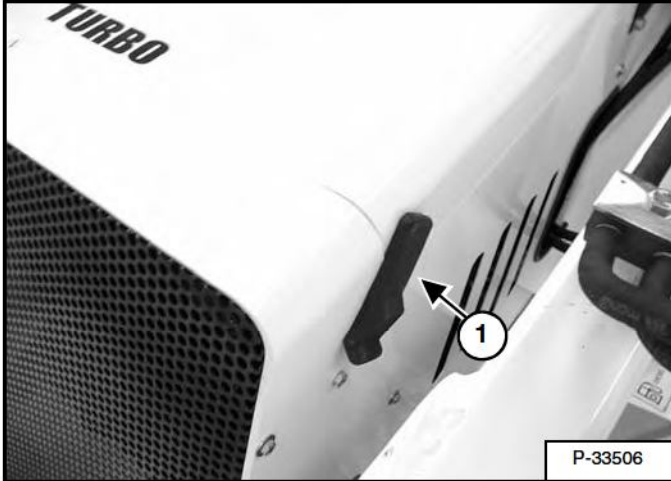

Open the latch (Item 1) [Figure 10-30-1] on each side of the engine cover.

Raise the engine cover.

Figure 10-30-2

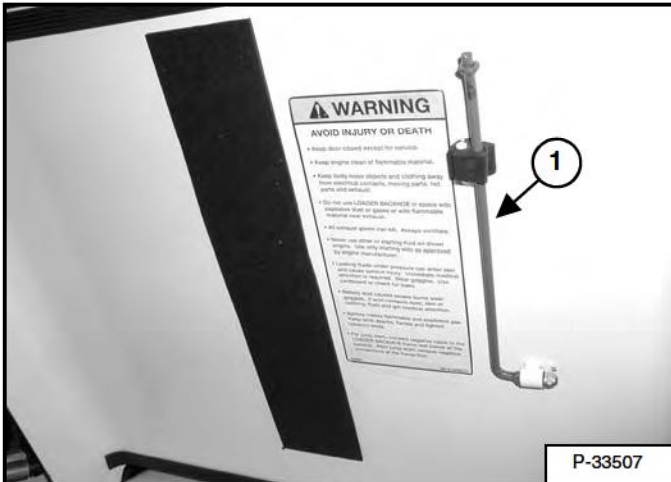

Remove the engine cover support rod (Item 1) [Figure 10-30-2] from the storage position.

Figure 10-30-3

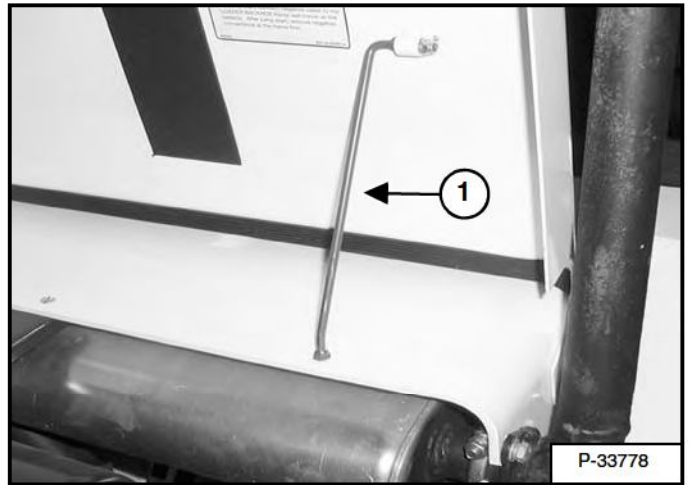

Place the end of the support rod (Item 1) [Figure 10-30-3] into the hole located on the hood to hold the engine cover open.

Dealer Copy -- Not for Resale

TRANSPORTING THE LOADER BACKHOE

Procedure

WARNING

Adequately designed ramps of sufficient strength are needed to support the weight of the machine when loading onto a transport vehicle. Wood ramps can break and cause personal injury.

W-2058-0494

Figure 10-40-1



Be sure the transport and towing vehicles are of adequate size and capacity. (See Performance on Page SPEC-10-2.)

The rear of the trailer must be blocked or supported (Item 1) [Figure 10-40-1] when loading or unloading the loader backhoe to prevent the front end of the trailer from raising up.

Figure 10-40-2

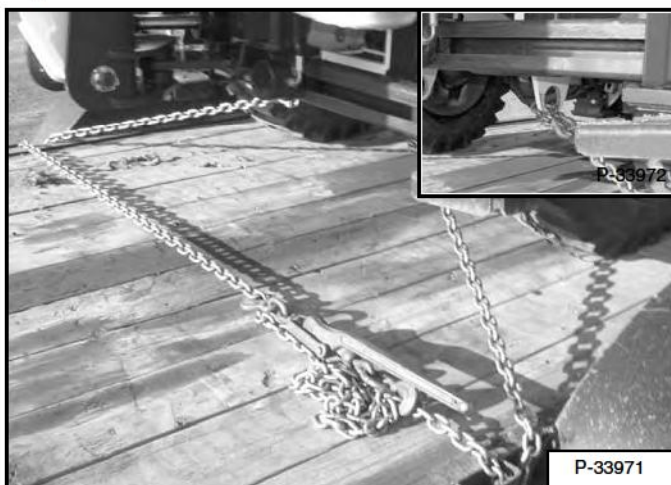

Figure 10-40-3

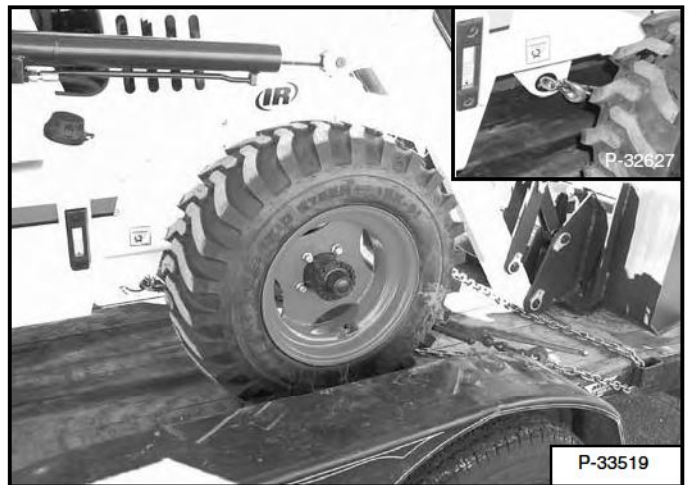
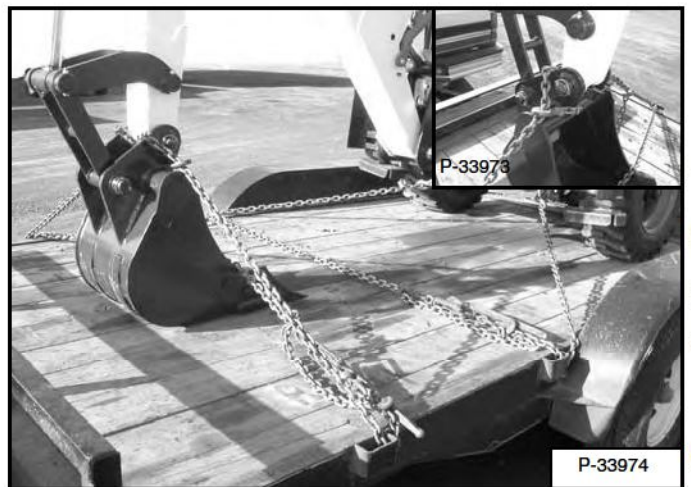

Figure 10-40-4



Use the following procedure to fasten the loader backhoe to the transport vehicle to prevent the loader backhoe from moving during sudden stops or when going up or down slopes.

- Lower the loader bucket.
- Lower the backhoe bucket.
- Stop the engine.
- Engage the parking brake.
- Install chains at the rear of the machine [Figure 10-40-2] front of the machine [Figure 10-40-3] and the backhoe [Figure 10-40-4].
- Fasten each end of the chain to the transport vehicle

For height restrictions when transporting the loader backhoe on a trailer, the backhoe boom lock **must not** be engaged. The backhoe boom **must** be lowered onto the trailer bed and chained.

Dealer Copy -- Not for Resale

TOWING THE LOADER BACKHOE

Procedure

Place blocks in front and behind rear wheels.

Remove the front floor panel. (See FLOOR PANELS on Page 50-30-1.)

Figure 10-50-1

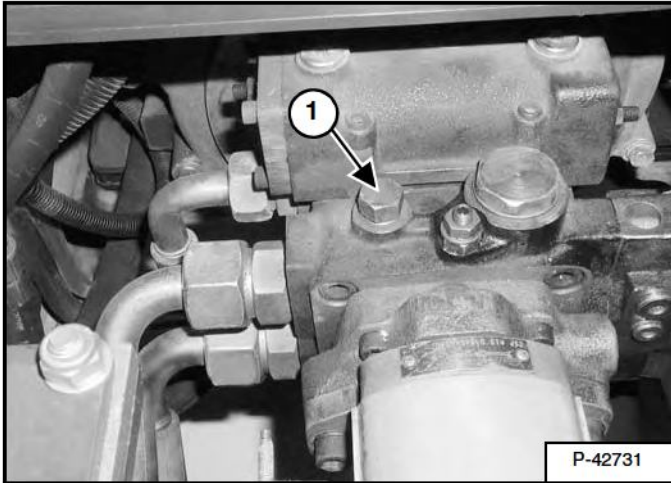

Loosen the tow valve (Item 1) [Figure 10-50-1].

Figure 10-50-2

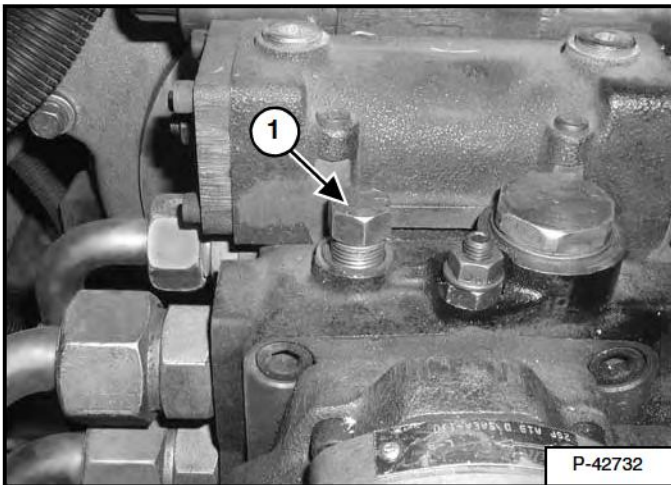

Rotate the tow valve (Item 1) [Figure 10-50-2] counterclockwise approximately three turns.

To prevent damage to the loader backhoe hydrostatic system, the loader backhoe must be towed only a short distance at a low speed. (Example: Moving the loader backhoe onto a transport vehicle.)

The towing chain (or cable) must be rated at 1-1/2 times the weight of the loader. (See Performance on Page SPEC-10-2.)

AXLE TOE-IN

Adjustment

WARNING

Never work on a machine with the lift arms up unless the lift arms are secured by an approved lift arm support device. Failure to use an approved lift arm support device can allow the lift arms or attachment to fall and cause injury or death.

W-2059-0598

Figure 10-60-1

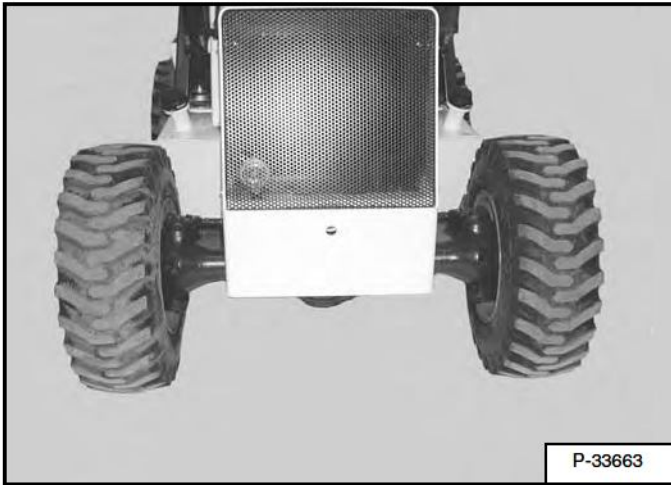

Turn the steering wheel until the front wheels are positioned as shown [Figure 10-60-1].

Figure 10-60-2

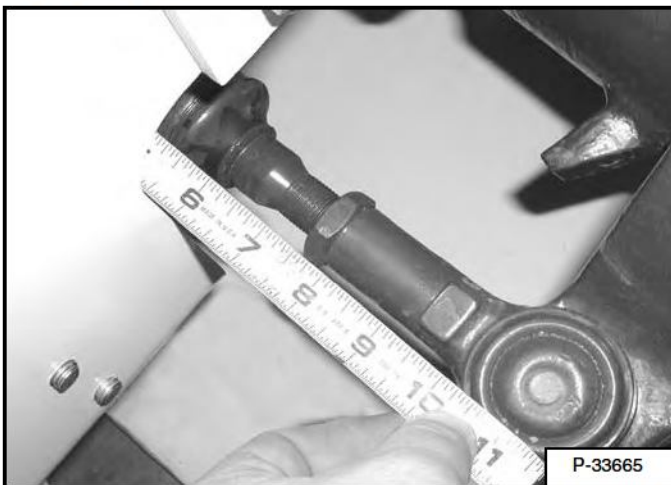

Measure the exposed part of the cylinder rod on each side of the steering cylinder housing making sure they are the same length [Figure 10-60-2].

Figure 10-60-3

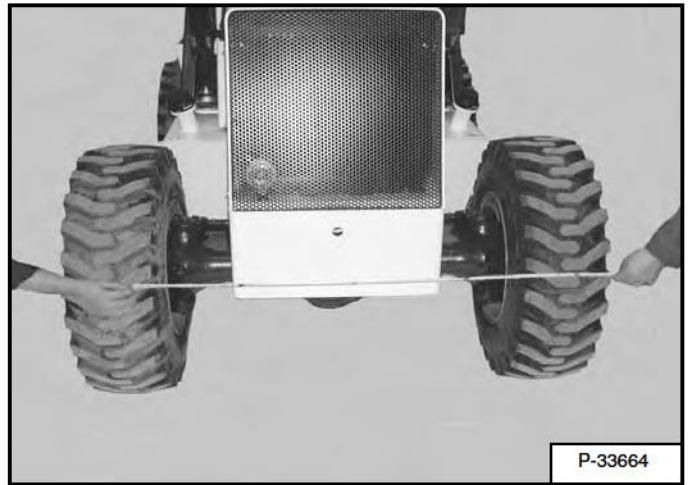

Measure the distance between the centerlines on the front of the tires and compare it to the measurement taken from the centerlines on the backside of the tires [Figure 10-60-3]. The measurement must be equal.

Figure 10-60-4

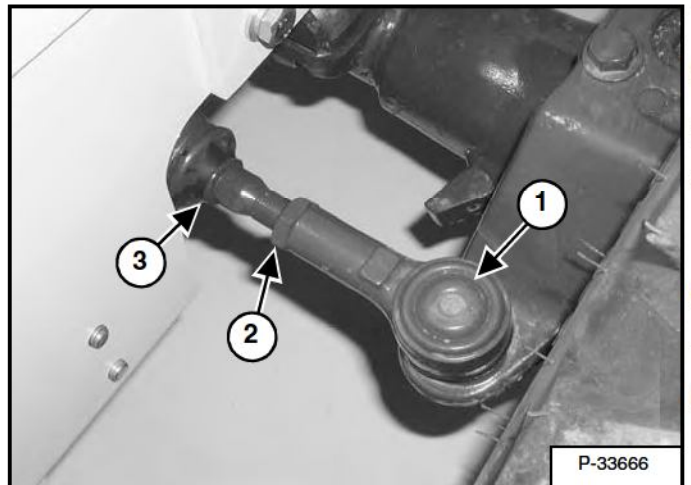

If measurement is not the same, adjust both tie rod ends (Item 1) [Figure 10-60-4] by loosening both jam nuts (Item 2) [Figure 10-60-4], loosen or tighten the track rod (Item 3) [Figure 10-60-4] of both tie rods until the measurement is the same.

Dealer Copy -- Not for Resale

SERVICE SCHEDULE

Chart

Maintenance work must be done at regular intervals. Failure to do so will result in excessive wear and early failures. The service schedule is a guide for correct maintenance of the Bobcat loader backhoe.

 <b style="font-size: 24pt; margin-left: 10px;">WARNING	<p>Instructions are necessary before operating or servicing machine. Read and understand the Operation & Maintenance Manual and signs (decals) on machine. Follow warnings and instructions in the manuals when making repairs, adjustments or servicing. Check for correct function after adjustments, repairs or service. Untrained operators and failure to follow instructions can cause injury or death.</p> <p style="text-align: right; font-size: 10pt;">W-2003-1285</p>
--	---

SERVICE SCHEDULE		HOURS					
ITEM	SERVICE REQUIRED	8-10	50	100	250	500	1000
Engine Oil	Check the engine oil level and add as needed.						
Hydraulic Fluid	Check fluid level and add as needed.						
Fuel Filter	Remove trapped water.						
Engine Air System	Check for leaks and damaged components.						
Engine Cooling System	Clean debris from oil cooler, radiator & grill. Check coolant level.						
Lift Arms, Cyl., Bob-Tach Pivot Pins, Wedges, Etc.	Lubricate with multi-purpose lithium based grease.						
Tires	Check for correct size, damaged tires and correct air pressure.						
Seat Belt, Seat Belt Retractors	Check the condition of seat belt. Clean or replace seat belt retractors as needed.						
Mirrors	Clean, adjust, replace if damaged						
Steering Valve	Check and set steering as required.						
Safety Signs and Safety Treads	Check for damaged signs (decals) and safety treads. Replace any signs or safety treads that are damaged or worn.						
Operator Cab	Check the fastening bolts, washers and nuts. Check the condition of the cab.						
Indicators and Lights	Check for correct operation of all indicators and lights.						
Parking Brake	Check operation, adjust as required.						
Backup Alarm	Check operation. Repair or replace as required.						
Hydraulic Fluid, Hoses and Tubelines	Check fluid level & add as needed. Check for damage & leaks. Repair or replace as needed.						
Front and Rear Differential	Check oil level. Add oil as needed.						
Wheel Nuts	Check for loose wheel nuts and tighten to 140 ft.-lbs.	□					
Battery	Check cables, connections and electrolyte level. Add distilled water as needed.						
Spark Arrestor Muffler	Empty the spark chamber (if equipped).						
Alternator/Fan Belt	Check tension and adjust as needed.		*				
Fuel Filter	Replace the filter element.		●				
Engine Oil and Filter	Replace oil & filter. Use CD or better grade oil and Bobcat filter.		†				
Hydraulic Oil Filter	Replace the filter element.						
Engine Air Filter	Replace the air filter element.		#				
Engine Cooling System	Flush cooling system and add new coolant.						
Hydraulic Reservoir	Replace the fluid and the filter.						
Differential Oil	Replace the differential oil.						

- Check wheel nut torque every 8 hours for the first 24 hours.
- * Inspect the new belt after first 50 hours.
- Also replace hydraulic/hydrostatic filter element when the transmission warning light comes ON.
- † First oil and filter change must occur at 50 hours; 250 hours thereafter.
- # After the first 500 hours on new engine, adjust engine valves; 1000 hours thereafter. (See Servicing The Cylinder Head on Page 70-80-15.)

Dealer Copy -- Not for Resale

AIR CLEANER SERVICE

Replacing Filter Element

Figure 10-80-1

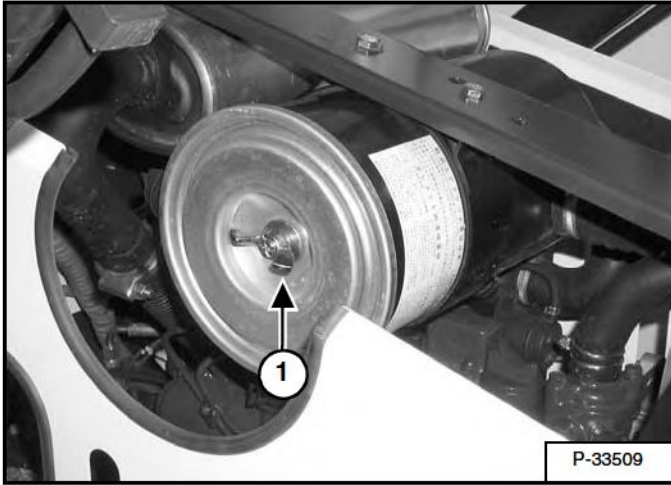

(See SERVICE SCHEDULE on Page 10-70-1.) for the correct service interval.

Open the engine cover. (See ENGINE COVER on Page 10-30-1.)

Loosen the filter cover nut (Item 1) [Figure 10-80-1].

Figure 10-80-2

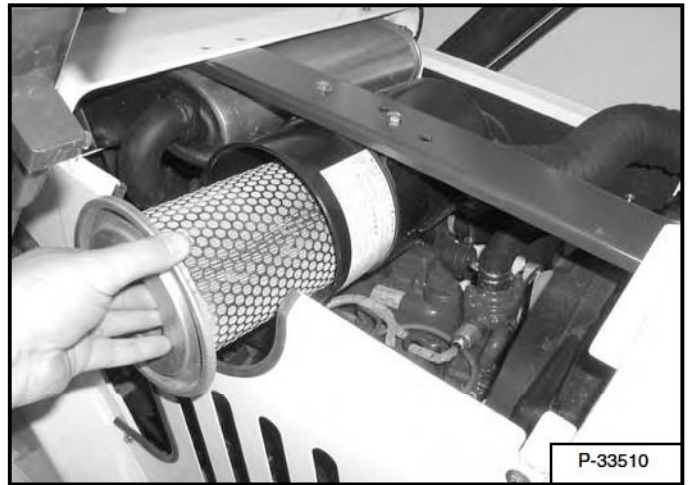

Remove the filter element and cover from the housing [Figure 10-80-2].

NOTE: Make sure all sealing surfaces are free of dirt and debris.

Install a new element onto the housing cover.

Install filter element/cover [Figure 10-80-2].

Tighten the filter cover nut (Item 1) [Figure 10-80-1].

Dealer Copy -- Not for Resale

ENGINE COOLING SYSTEM

Coolant Replacement



Do not remove radiator cap when the engine is hot. You can be seriously burned.

W-2070-1285

Figure 10-90-1

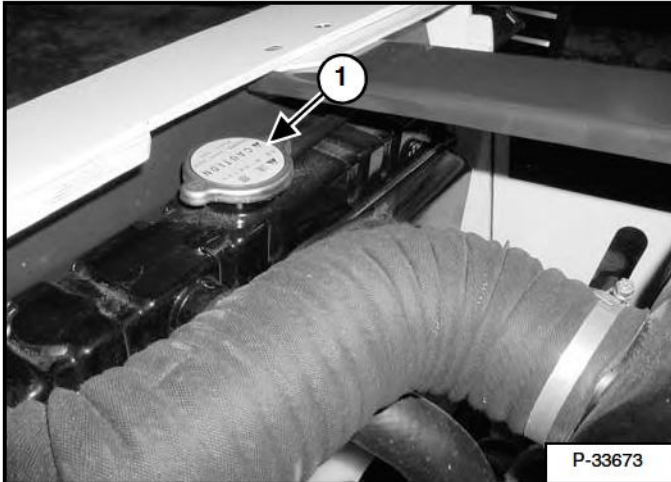

(See SERVICE SCHEDULE on Page 10-70-1.) for the correct service intervals.

Stop the engine, open the engine cover.

When the engine is cool, loosen and remove the radiator cap (Item 1) [Figure 10-90-1].

Figure 10-90-2



Open the radiator drain valve (Item 1) [Figure 10-90-2] at bottom of radiator. Drain the coolant into a container.

Figure 10-90-3

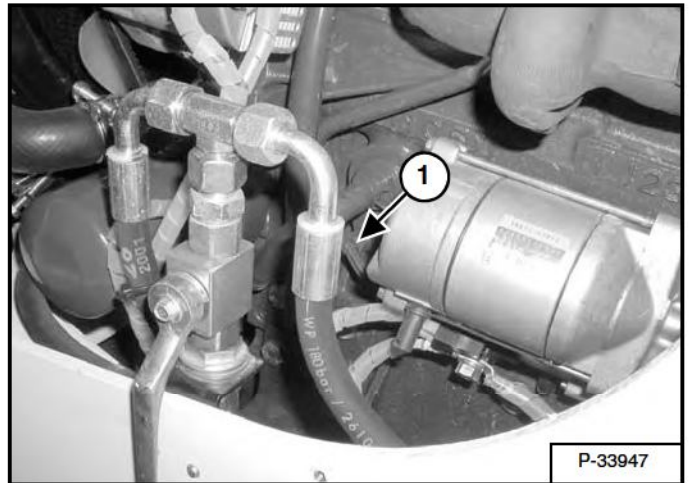

Open the engine block drain valve (Item 1) [Figure 10-90-3] and drain the coolant into a container.

After all the coolant is removed, close both drain valves.

Recycle or dispose of coolant in an environmentally safe manner.

Mix the coolant in a separate container. (See Specifications on Page SPEC-50-1 for correct capacity.)

NOTE: The loader backhoe is factory filled with ethylene glycol. DO NOT mix propylene glycol with ethylene glycol.

Add premixed coolant; 50% water and 50% ethylene glycol to the recovery tank if the coolant level is low.

One gallon and one pint of ethylene glycol mixed with one gallon of water is the correct mixture of coolant to provide a -34°F (-37°C) freeze protection.

Use a refractometer to check the condition of ethylene glycol in your cooling system.

Fill the radiator with the premixed coolant until it is full.

Run the engine at idle speed for about 5-10 minutes to remove the air from the cooling system (leave the radiator cap off during this operation).

Stop the engine. Check the coolant level and add as needed to bring it up to the radiator filler neck. Install the radiator cap and tighten.

Dealer Copy -- Not for Resale

FUEL SYSTEM

Fuel Specifications

Use only clean, high quality diesel fuel, Grade No. 2 or Grade No. 1.

The following is one suggested blending guideline which should prevent fuel gelling during cold temperatures:

Temp. F° (C°)	No. 2	No. 1
+15° (9°)	100%	0%
Down to -20° (-29°)	50%	50%
Below -20° (-29°)	0%	100%

Contact your fuel supplier for local recommendations.

Filling The Fuel Tank

Figure 10-100-1

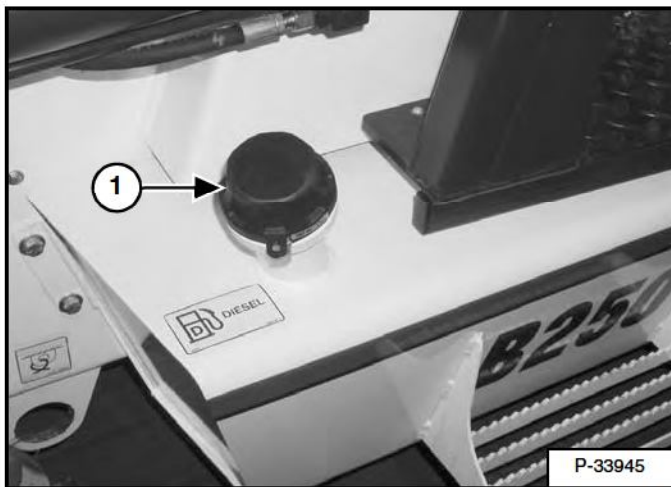

Remove the fuel fill cap (Item 1) [Figure 10-100-1].

! WARNING

Always clean up spilled fuel or oil. Keep heat, flames, sparks or lighted tobacco away from fuel and oil. Failure to use care around combustibles can cause explosion or fire which can result in injury or death.

W-2103-1285

! WARNING

Stop and cool the engine before adding fuel. **NO SMOKING!** Failure to obey warnings can cause an explosion or fire.

W-2063-0887

Figure 10-100-2

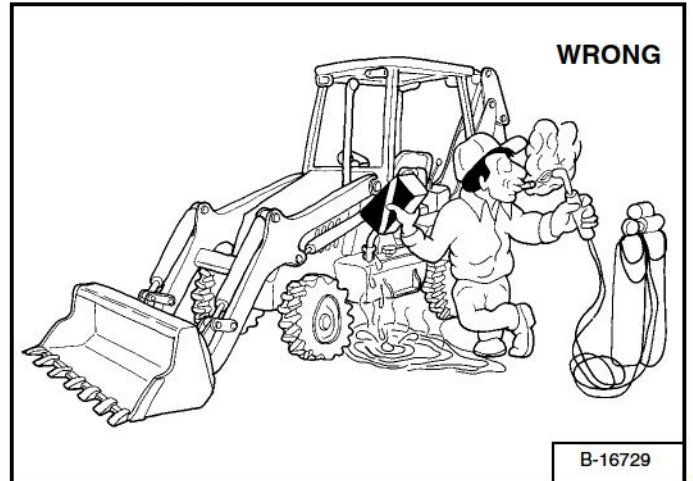

Use a clean, approved safety container to add fuel of the correct specifications. Add fuel only in an area that has free movement of air and no open flames or sparks. **NO SMOKING!** [Figure 10-100-2].

Install and tighten the fuel fill cap (Item 1) [Figure 10-100-1].

Dealer Copy -- Not for Resale

FUEL SYSTEM (CONT'D)

Fuel Filter

Figure 10-100-3

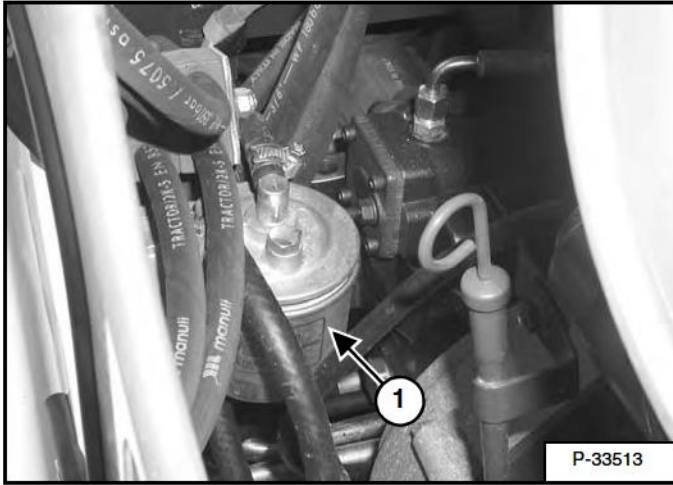

(See SERVICE SCHEDULE on Page 10-70-1.) for the service interval for removing water from, or replacing the fuel filter.

Open the engine cover.

Remove the filter element (Item 1) [Figure 10-100-3].

Clean the area around the filter housing. Put clean oil on the seal of the new filter element. Install the fuel filter, and hand tighten.

Remove the air from the fuel system. (See Removing Air From The Fuel System on Page 10-100-2.)

Removing Air From The Fuel System

WARNING

Diesel fuel or hydraulic fluid under pressure can penetrate skin or eyes, causing serious injury or death. Fluid leaks under pressure may not be visible. Use a piece of cardboard or wood to find leaks. Do not use your bare hand. Wear safety goggles. If fluid enters skin or eyes, get immediate medical attention from a physician familiar with this injury.

W-2072-0496

WARNING

Always clean up spilled fuel or oil. Keep heat, flames, sparks or lighted tobacco away from fuel and oil. Failure to use care around combustibles can cause explosion or fire which can result in injury or death.

W-2103-1285

Figure 10-100-4

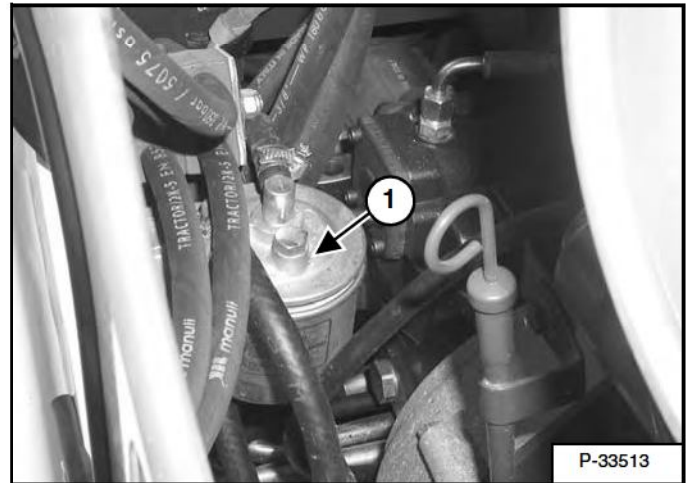

After replacing the filter element or when the fuel tank has run out of fuel, the air must be removed from the fuel system before starting the engine.

Open the vent (Item 1) [Figure 10-100-4] on the fuel filter housing.

Turn the engine over with the starter until fuel flows from the vent with no air bubbles.

Close the vent (Item 1) [Figure 10-100-4].

ENGINE LUBRICATION SYSTEM

Checking Engine Oil

Figure 10-110-1



Check the engine oil level every day before starting the engine for the work shift.

Open the engine cover and remove the dipstick (Item 1) [Figure 10-110-1].

Keep the oil level between the marks on the dipstick.

Engine oil is also used to provide engine cooling. Check oil level every day for correct engine lubrication and cooling.

Use a good quality motor oil that meets API Service Classification of CD or better. (See Oil Chart.)

Oil Chart

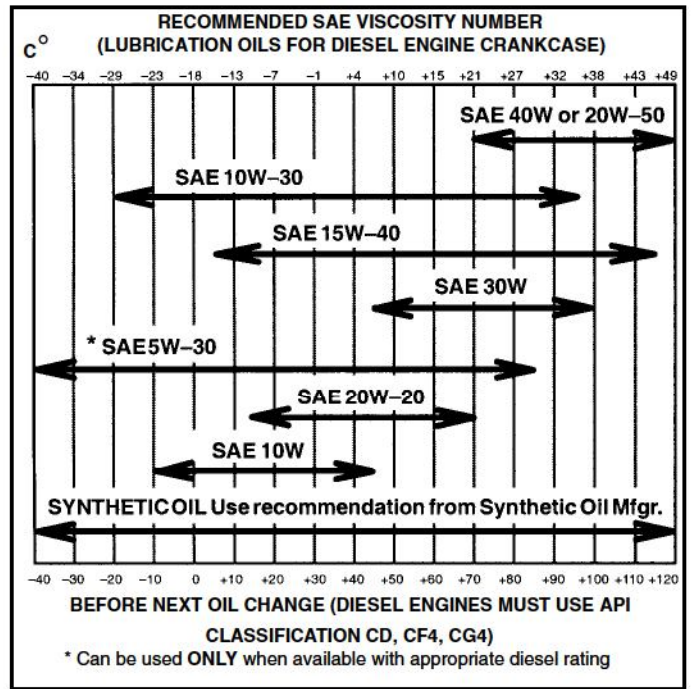

Dealer Copy -- Not for Resale

ENGINE LUBRICATION SYSTEM (CONT'D)

Replacing Oil And Filter

(See SERVICE SCHEDULE on Page 10-70-1.) for the service interval for replacing the engine oil and filter.

Run the engine until it is at operating temperature. Stop the engine.

Figure 10-110-2

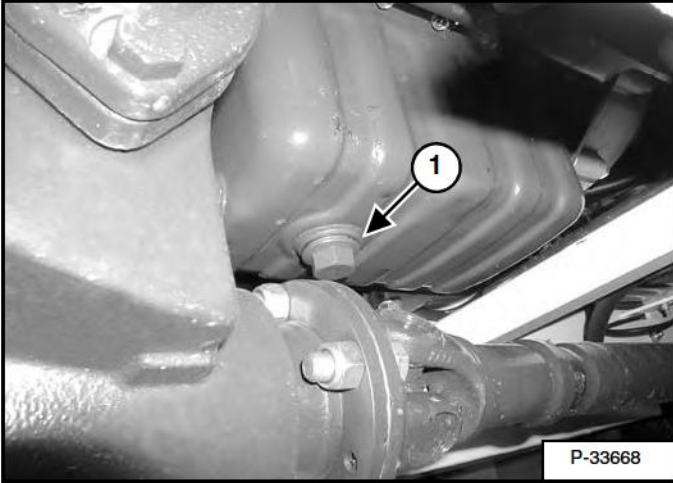

Remove the drain plug (Item 1) [Figure 10-110-2].

Drain the oil into a container and dispose of used oil in an environmentally safe manner.

Reinstall the drain plug.

WARNING

Always clean up spilled fuel or oil. Keep heat, flames, sparks or lighted tobacco away from fuel and oil. Failure to use care around combustibles can cause explosion or fire which can result in injury or death.

W-2103-1285

Figure 10-110-3

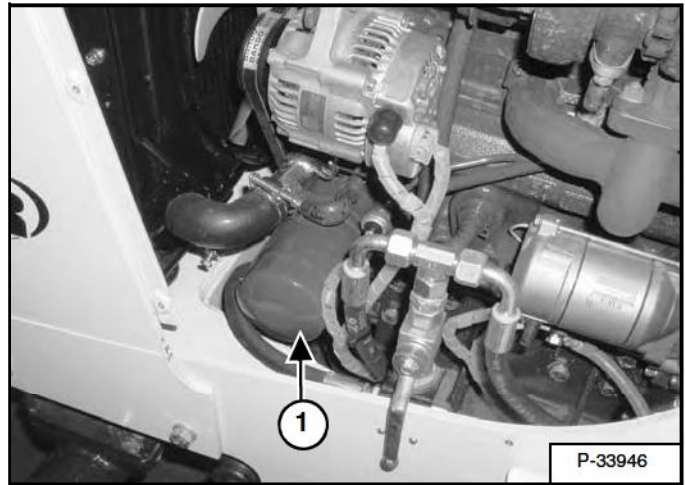

Remove the oil filter (Item 1) [Figure 10-110-3].

Clean the filter housing surface.

Use genuine Bobcat filter only.

Put oil on the new filter gasket. Install the filter and hand tighten.

Figure 10-110-4

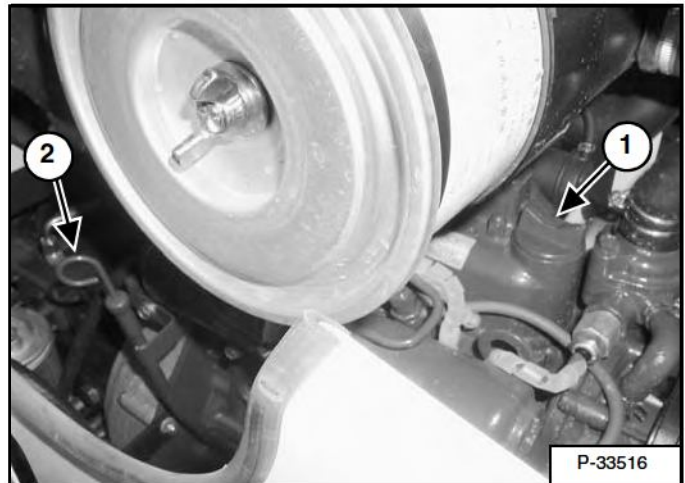

Remove the fill cap (Item 1) [Figure 10-110-4]. Put 4.3 qts. (4 L) of oil in the engine.

Start the engine and let it run for several minutes.

Stop the engine and check for leaks at the oil filter.



Suggest:

If the above button click is invalid.

Please download this document

first, and then click the above link

to download the complete manual.

Thank you so much for reading

ENGINE LUBRICATION SYSTEM (CONT'D)

Replacing Oil And Filter (Cont'd)

Figure 10-110-5

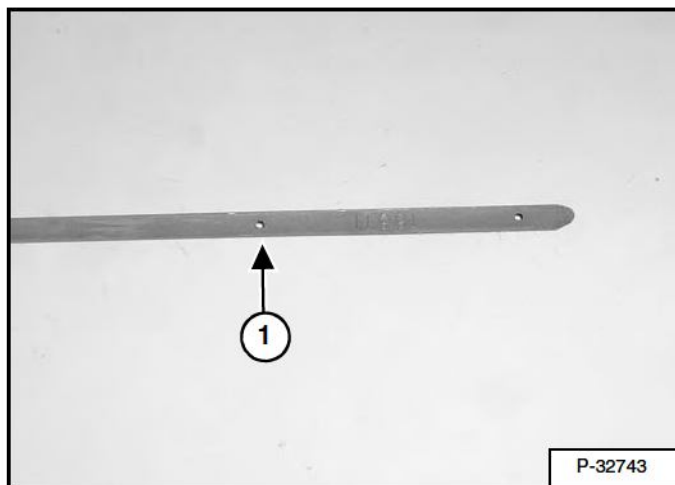

Remove the dipstick (Item 2) [Figure 10-110-4 on Page 10-110-2] and check the oil level. Add oil as needed if it is not at the top mark on the dipstick (Item 1) [Figure 10-110-5].

Install the dipstick and close the engine cover.

<https://www.ebooklibonline.com>

Hello dear friend!

Thank you very much for reading.

Enter the link into your browser.

The full manual is available for immediate download.

<https://www.ebooklibonline.com>