

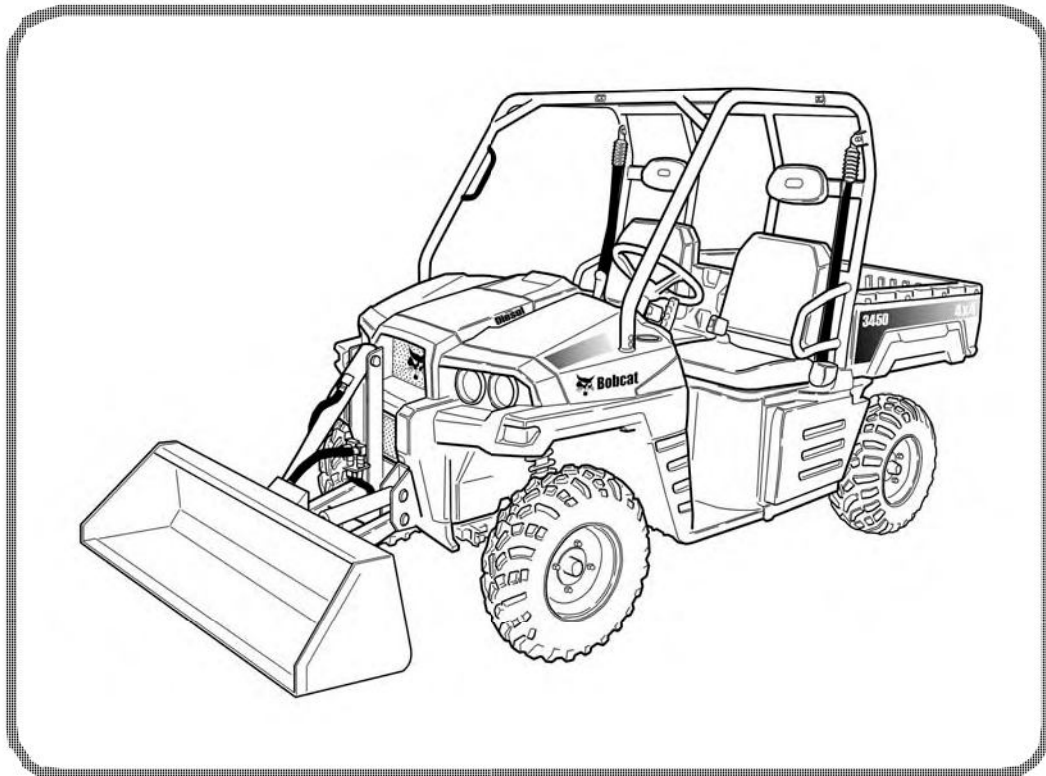

Bobcat®

Service Manual 3450 Utility Vehicle

S/N AJNY11001 & Above



Dealer Copy -- Not for Resale



MAINTENANCE SAFETY



WARNING

Instructions are necessary before operating or servicing utility vehicle. Read and understand the Operation & Maintenance Manual, Operator's Handbook and signs (decals) on the utility vehicle. Follow warnings and instructions in the manuals when making repairs, adjustments or servicing. Check for correct function after adjustments, repairs or service. Untrained operators and failure to follow instructions can cause injury or death.



Safety Alert Symbol: This symbol with a warning statement, means: "Warning, be alert! Your safety is involved!" Carefully read the message that follows.

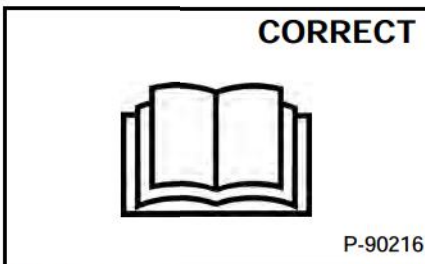

⚠ Never service the utility vehicle without instructions.

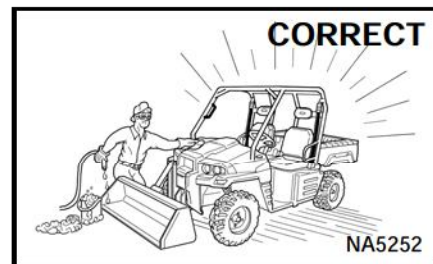

⚠ Cleaning and maintenance are required daily.

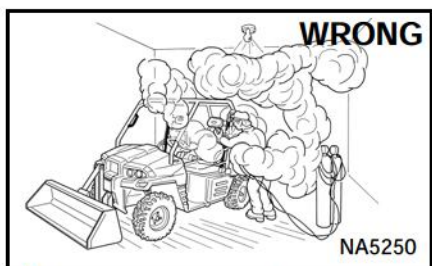

- ⚠ Have good ventilation when welding or grinding painted parts.
- ⚠ Wear dust mask when grinding painted parts. Toxic dust and gas can be produced.
- ⚠ Avoid exhaust fume leaks which can kill without warning. Exhaust system must be tightly sealed.

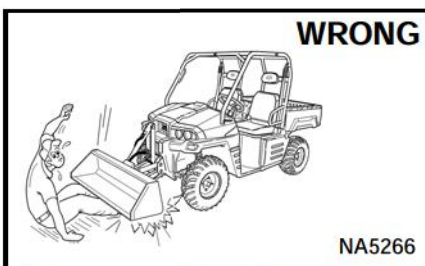

⚠ Disconnecting or loosening any hydraulic tubeline, hose, fitting, component or a part failure can cause attachment arm to drop.

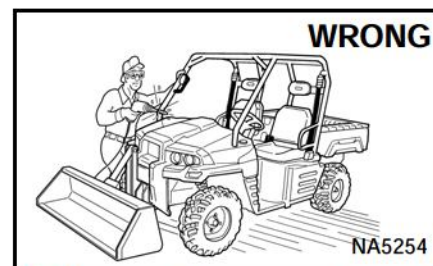

⚠ Never modify equipment or add attachments and accessories not approved by Bobcat Company.

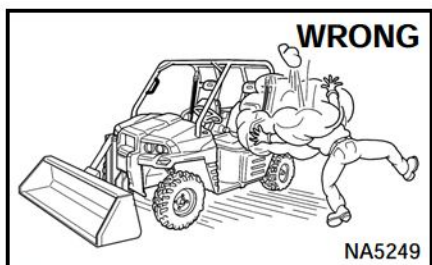

- ⚠ Stop, cool and clean engine of flammable materials before checking fluids.
- ⚠ Never service or adjust utility vehicle with the engine running unless instructed to do so in the manual.
- ⚠ Avoid contact with leaking hydraulic fluid or diesel fuel under pressure. It can penetrate the skin or eyes.
- ⚠ Never fill fuel tank with engine running, while smoking or when near open flame.

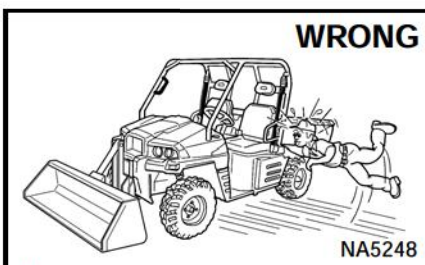

- ⚠ Keep body, jewelry and clothing away from moving parts, electrical contact, hot parts and exhaust.
- ⚠ Wear eye protection to guard from battery acid, compressed springs, fluids under pressure and flying debris when engines are running or tools are used. Use eye protection approved for type of welding.
- ⚠ Keep access doors closed except for service.



- ⚠ Lead-acid batteries produce flammable and explosive gases.
- ⚠ Keep arcs, sparks, flames and lighted tobacco away from batteries.
- ⚠ Batteries contain acid which burns eyes or skin on contact. Wear protective clothing. If acid contacts body, flush well with water. For eye contact, flush well and get immediate medical attention.

Maintenance procedures which are given in the Operation & Maintenance Manual can be performed by the owner/operator without any specific technical training. Maintenance procedures which are **not** in the Operation & Maintenance Manual must be performed **ONLY BY QUALIFIED BOBCAT SERVICE PERSONNEL**. Always use genuine Bobcat replacement parts.

Dealer Copy -- Not for Resale

MSW42-0610

CONTENTS

SAFETY AND MAINTENANCE	10-01
DRIVE SYSTEM	20-01
MAINFRAME	30-01
ELECTRICAL SYSTEM AND ANALYSIS	40-01
ENGINE SERVICE	50-01
HYDRAULIC SYSTEM	60-01
SPECIFICATIONS	SPEC-01
ALPHABETICAL INDEX	INDEX-01

Dealer Copy -- Not for Resale

FOREWORD

FOREWORD	1-7
SAFETY INSTRUCTIONS	1-9
FIRE PREVENTION	1-11
Maintenance	1-11
Operation	1-11
Electrical	1-11
Fueling	1-11
Starting	1-11
Spark Arrester Exhaust System	1-11
Welding And Grinding	1-11
Fire Extinguishers	1-12
SERIAL NUMBER LOCATIONS	1-13
Utility Vehicle Serial Number	1-13
Engine Serial Number	1-13
DELIVERY REPORT	1-14
UTILITY VEHICLE IDENTIFICATION	1-15

Dealer Copy -- Not for Resale

<https://www.ebooklibonline.com>

Hello dear friend!

Thank you very much for reading.

Enter the link into your browser.

The full manual is available for immediate download.

<https://www.ebooklibonline.com>

FOREWORD

This manual is for the Utility Vehicle mechanic. It provides necessary servicing and adjustment procedures for the Utility Vehicle and its component parts and systems. Refer to the for operating instructions, starting procedure, daily checks, etc.

A general inspection of the following items must be made after the Vehicle has had service or repair:

1. Check that the ROPS is in good condition and is not modified.



2. Check that ROPS mounting hardware is tightened and is Bobcat approved.



3. The operator and passenger seat belts must be correctly installed, functional and in good condition.

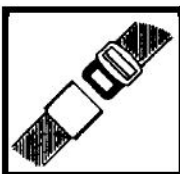

4. Safety signs (decals) must be legible and in the correct location.



5. Foot pedals must return to neutral.

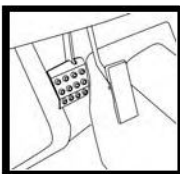

6. Check for correct function of the head lights and tail lights.



7. The parking brake must function correctly.



8. RapidLink™ must function correctly and be in good condition (3450 only).

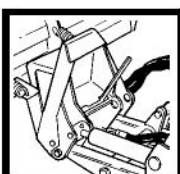

9. Check for correct function of indicator lamps.

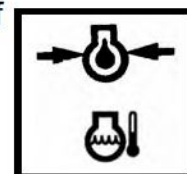

10. Check hydraulic fluid level, engine oil level and fuel supply (3450 only).

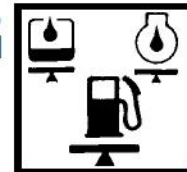

11. Inspect for fluid, oil or hydraulic fluid leaks (3450 only).

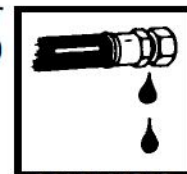

12. Lubricate the machine.



13. Check the condition of the battery and cables.

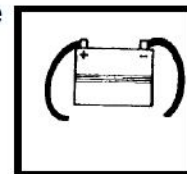

14. Inspect the air cleaner for damage or leaks. Check the condition of the element.

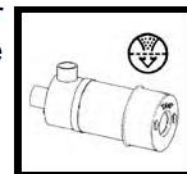

15. Check the electrical charging system.

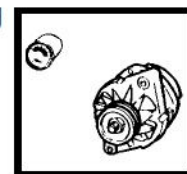

16. Check tires for wear and pressure. Use only approved tires.



Dealer Copy -- Not for Resale

FW UV-0510 SM

17. Inspect for loose or broken parts or connections.



20. Check for correct function of the Start Interlock System before the machine is returned to the customer.



18. Check for any field modification not completed.



21. Check function or condition of all equipped options and accessories.



19. Operate the vehicle and check all functions.

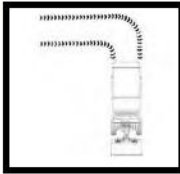

22. Recommend to the owner that all necessary corrections be made before the machine is returned to service.



**CALIFORNIA
PROPOSITION 65 WARNING**

Diesel engine exhaust and some of its constituents are known to the state of California to cause cancer, birth defects and other reproductive harm.

SAFETY INSTRUCTIONS



Safety Alert Symbol

This symbol with a warning statement means: "Warning, be alert! Your safety is involved!" Carefully read the message that follows.



WARNING

Operator must have instructions before operating the utility vehicle. Untrained operators can cause injury or death.

W-2855-0510

IMPORTANT

This notice identifies procedures which must be followed to avoid damage to the utility vehicle.

I-2317-0510



DANGER

The signal word DANGER on the utility vehicle and in the manuals indicates a hazardous situation which, if not avoided, will result in death or serious injury.

D-1022-0510



WARNING

The signal word WARNING on the utility vehicle and in the manuals indicates a potentially hazardous situation which, if not avoided, could result in death or serious injury.

W-2856-0510

The following publications provide information on the safe use and maintenance of the Bobcat utility vehicle and attachments:

- The Delivery Report is used to assure that complete instructions have been given to the new owner and that the vehicle is in safe operating condition.
- The Operation & Maintenance Manual delivered with the vehicle or attachment contains operating information as well as routine maintenance and service procedures. It is a part of the vehicle and can be stored in a container provided on the vehicle. Replacement Operation & Maintenance Manuals can be ordered from your Bobcat dealer.
- Safety signs (decals) instruct on the safe operation and care of your Bobcat utility vehicle or attachment. The signs and their locations are shown in the Operation & Maintenance Manual. Replacement signs are available from your Bobcat dealer.
- An Operator's Handbook fastened to the operator cab. It's brief instructions are convenient to the operator. The handbook is available from your dealer in an English edition or one of many other languages. See your Bobcat dealer for more information on translated versions.
- The Service Manual and Parts Manual are available from your dealer for use by mechanics to do shop-type service and repair work.
- The Utility Vehicle Operator Training Course is available through your local dealer or at www.training.bobcat.com or www.bobcat.com. This course is intended to provide rules and practices of correct operation of the utility vehicle. The course is available in English and Spanish versions.
- The Utility Vehicle Safety Video is available from your Bobcat dealer or at www.training.bobcat.com or www.bobcat.com.

Dealer Copy -- Not for Resale

SI UV-0511 SM

FIRE PREVENTION



Maintenance

The utility vehicle and some attachments and accessories have components that are at high temperatures under normal operating conditions. The primary source of high temperatures is the engine and exhaust system. The electrical system, if damaged or incorrectly maintained, can be a source of arcs or sparks.

Flammable debris (leaves, straw, etc.) must be removed regularly. If flammable debris is allowed to accumulate, it can cause a fire hazard. Clean often to avoid this accumulation. Flammable debris in the engine compartment is a potential fire hazard.

The operator's area, engine compartment and engine cooling system must be inspected every day and cleaned if necessary to prevent fire hazards and overheating.

All fuels, most lubricants and some coolants mixtures are flammable. Flammable fluids that are leaking or spilled onto hot surfaces or onto electrical components can cause a fire.

Operation

Do not use the utility vehicle where exhaust, arcs, sparks or hot components can contact flammable material, explosive dust or gases. Do not park this vehicle near open flames or pilot lights.

Electrical



Check all electrical wiring and connections for damage. Keep the battery terminals clean and tight. Repair or replace any damaged part or wires that are loose or frayed.

Battery gas can explode and cause serious injury. Use the procedure in the Operation & Maintenance Manual for connecting the battery and for jump starting. Do not jump start or charge a frozen or damaged battery. Keep any open flames or sparks away from batteries. Do not smoke in battery charging area.

Fueling



Stop the engine and let it cool before adding fuel. No smoking! Do not refuel a utility vehicle near open flames or sparks. Fill the fuel tank outdoors.

Starting

Use the procedure in the Operation & Maintenance Manual for connecting the battery and for jump starting.

Spark Arrester Exhaust System

The spark arrester exhaust system is designed to control the emission of hot particles from the engine and exhaust system, but the muffler and the exhaust gases are still hot.

Check the spark arrester exhaust system regularly to make sure it is maintained and working properly. Use the procedure in the Operation & Maintenance Manual for cleaning the spark arrester muffler

Welding And Grinding

Always clean the utility vehicle attachments and accessories, disconnect the battery, and disconnect the wiring from the Bobcat controllers before welding. Cover fuel tank, rubber hoses, battery and all other flammable parts. Keep a fire extinguisher near the utility vehicle when welding.

Have good ventilation when grinding or welding painted parts. Wear dust mask when grinding painted parts. Toxic dust or gas can be produced.

Dust generated from repairing nonmetallic parts such as hoods, fenders or covers can be flammable or explosive. Repair such components in a well ventilated area away from open flames or sparks.

Dealer Copy -- Not for Resale

FIRE PREVENTION (CONT'D)

Fire Extinguishers

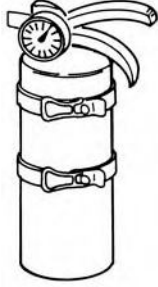

Know where fire extinguishers and first aid kits are located and how to use them. Inspect the fire extinguisher and service the fire extinguisher regularly. Obey the recommendations on the instructions plate.

SERIAL NUMBER LOCATIONS

Always use the serial number of the utility vehicle when requesting service information or when ordering parts. Early or later models (identification made by serial number) may use different parts, or it may be necessary to use a different procedure in doing a specific service operation.

Utility Vehicle Serial Number

Figure 1

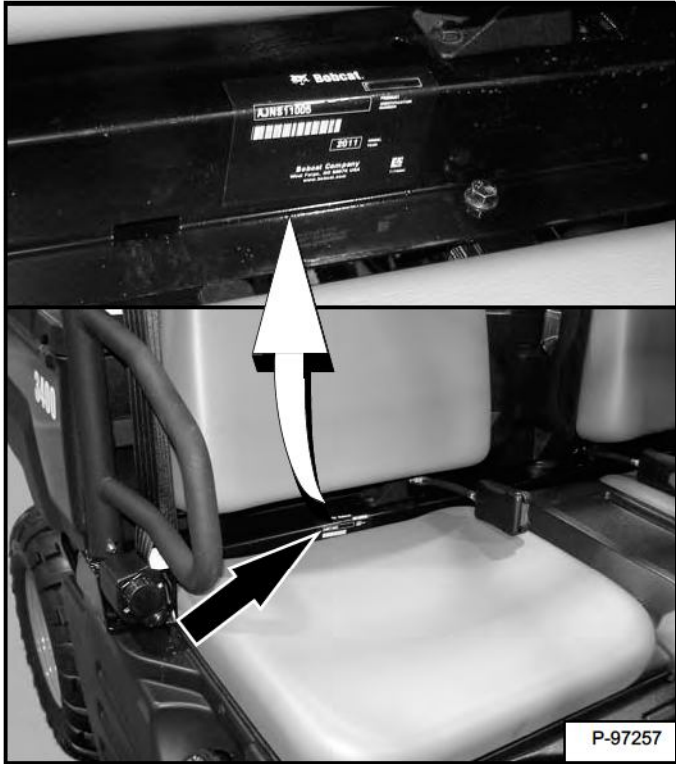

The utility vehicle serial number plate is located on the seat frame just behind the passenger(s) seat [Figure 1].

Figure 2

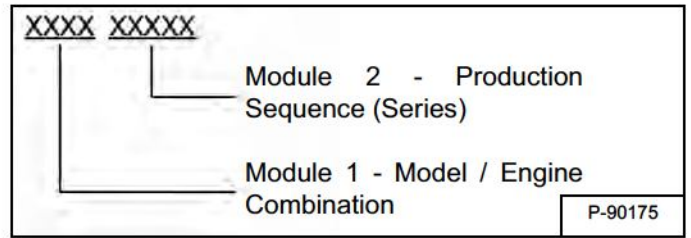

Explanation of utility vehicle Serial Number [Figure 2]:

1. The four digit Model / Engine Combination Module number identifies the model number and engine combination.
2. The five digit Production Sequence Number identifies the order which the utility vehicle is produced.

Engine Serial Number

Figure 3

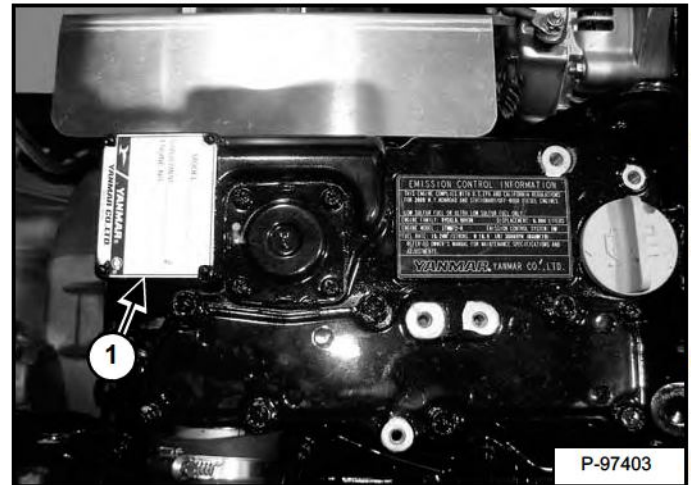

The engine serial number is located on the top of the engine (Item 1) [Figure 3].

Dealer Copy -- Not for Resale

DELIVERY REPORT

Figure 4

The diagram shows a form titled "DELIVERY REPORT" with various sections for text entry, including a "WARNING" section. A small box at the bottom right of the form contains the identifier "B-16315".

The delivery report [Figure 4] must be completed by the dealer and signed by the owner or operator when the Bobcat utility vehicle is delivered. An explanation of the form must be given to the owner.

UTILITY VEHICLE IDENTIFICATION

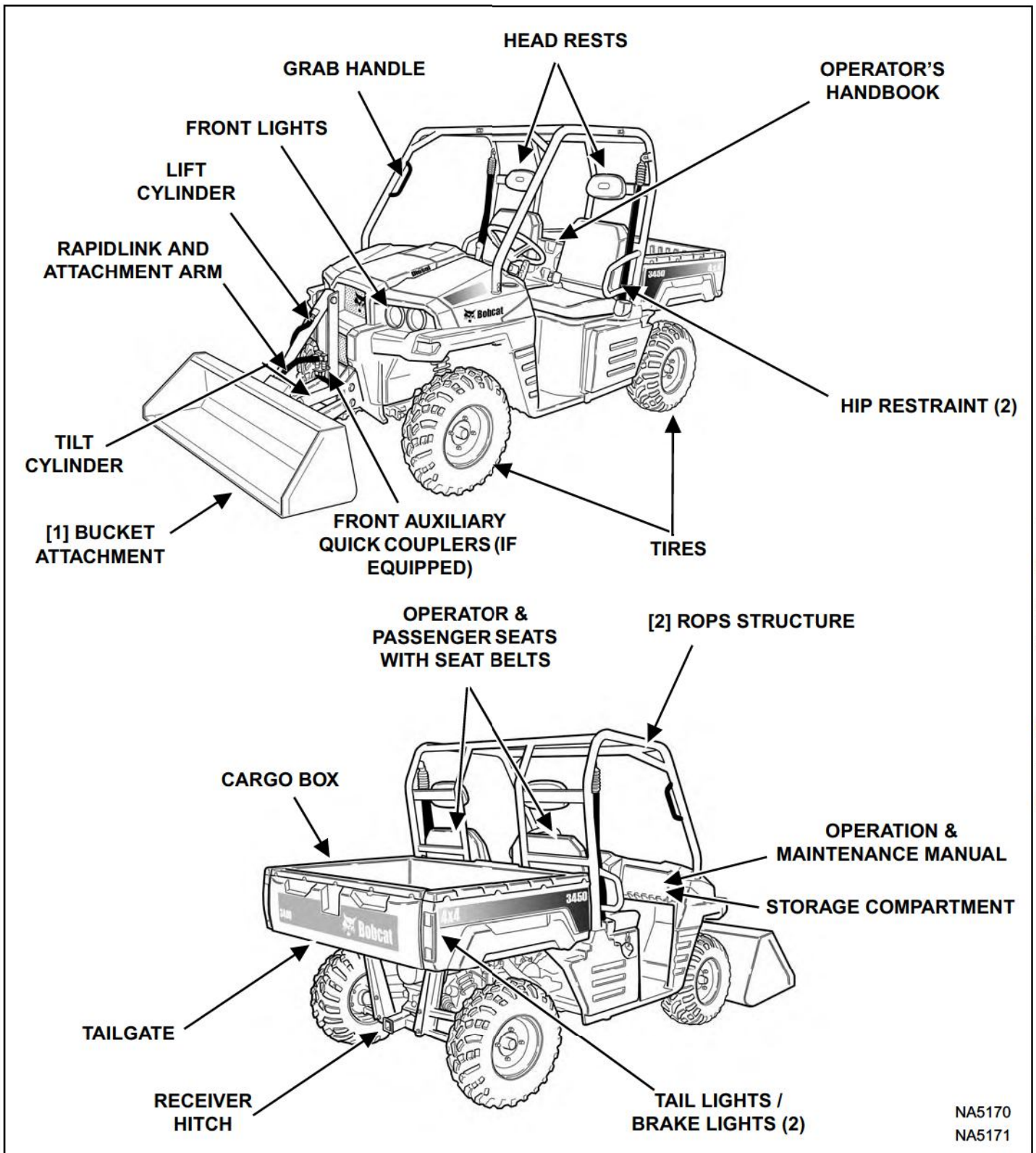

Dealer Copy -- Not for Resale

NA5170
NA5171

[1] BUCKET - Buckets and other attachments are available for the 3450 utility vehicle.

[2] ROPS - Rollover Protective Structure, per OSHA 1928.53: 2006, ISO 5700: 2006 and SAE J2194: 2009.

SAFETY AND MAINTENANCE

LIFTING AND BLOCKING THE UTILITY VEHICLE	10-10-1
Procedure	10-10-1
ROLLOVER PROTECTIVE STRUCTURE (ROPS)	10-20-1
Description	10-20-1
TRANSPORTING THE UTILITY VEHICLE ON A TRAILER	10-30-1
Loading And Unloading	10-30-1
Fastening	10-30-1
TOWING THE UTILITY VEHICLE	10-40-1
Procedure	10-40-1
SERVICE SCHEDULE	10-50-1
Chart	10-50-1
AIR CLEANER SERVICE	10-60-1
Pre-Filter Element	10-60-1
Replacing Filter Element	10-60-2
ENGINE COOLING SYSTEM	10-70-1
Checking Level	10-70-1
Cleaning	10-70-2
Removing And Replacing Coolant	10-70-3
FUEL SYSTEM	10-80-1
Fuel Specifications	10-80-1
Biodiesel Blend Fuel	10-80-1
Filling The Fuel Tank	10-80-2
Fuel Filter	10-80-2
Removing Air From The Fuel System	10-80-3
Filling A Portable Fuel Container	10-80-3
ENGINE LUBRICATION SYSTEM	10-90-1
Checking And Adding Engine Oil	10-90-1
Engine Oil Chart	10-90-1
Removing And Replacing Oil And Filter	10-90-2
CONTINUOUS VARIABLE TRANSMISSION (CVT)	10-100-1
CVT Drying	10-100-1
CVT Filter	10-100-2

Dealer Copy -- Not for Resale

GEARCASE	10-110-1
Checking Transmission Fluid	10-110-1
Transmission Fluid	10-110-1
Adding Transmission Fluid	10-110-1
Removing And Replacing Transmission Fluid	10-110-1
Checking Front Gearcase Fluid	10-110-2
Front Gearcase Fluid	10-110-2
Adding Front Gearcase Fluid	10-110-2
Removing And Replacing Front Gearcase Fluid	10-110-2
Checking Rear Gearcase Fluid	10-110-3
Rear Gearcase Fluid	10-110-3
Adding Rear Gearcase Fluid	10-110-3
Removing And Replacing Rear Gearcase Fluid	10-110-3
TIRE MAINTENANCE	10-120-1
Tires	10-120-1
Tire Tread Depth	10-120-1
Axle And Wheel Nut Torque	10-120-1
Wheel Removal And Installation	10-120-1
Mounting	10-120-2
Tire Pressure	10-120-2
SPARK ARRESTER MUFFLER	10-130-1
Cleaning Procedure	10-130-1
UTILITY VEHICLE STORAGE AND RETURN TO SERVICE	10-140-1
Storage	10-140-1
Return To Service	10-140-1
STOPPING THE ENGINE AND LEAVING THE UTILITY VEHICLE	10-150-1
Procedure	10-150-1
RELIEVING HYDRAULIC PRESSURE	10-160-1
Procedure	10-160-1
HYDRAULIC SYSTEM	10-170-1
Description	10-170-1
Checking Fluid	10-170-1
Hydraulic Fluid	10-170-1
Removing And Replacing Hydraulic Fluid	10-170-2

LIFTING AND BLOCKING THE UTILITY VEHICLE

Procedure

For service work under the utility vehicle, or to remove the wheels, always support the utility vehicle with jackstands or blocks of adequate capacity for weight of utility vehicle (See Performance on Page SPEC-10-2.)

Always park the utility vehicle on a flat level surface.

Engage the park brake. Stop the engine and put the gear selector in gear.

If removing wheel(s), loosen the wheel nuts slightly before lifting the vehicle.



AVOID INJURY OR DEATH

Instructions are necessary before operating or servicing machine. Read and understand the Operation & Maintenance Manual, Operator's Handbook and signs (decals) on machine. Follow warnings and instructions in the manuals when making repairs, adjustments or servicing. Check for correct function after adjustments, repairs or service. Untrained operators and failure to follow instructions can cause injury or death.

W-2003-0807

Figure 10-10-1

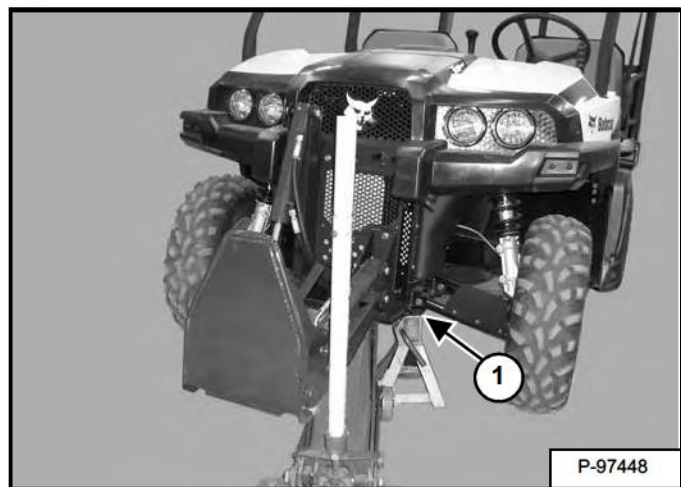

Place the jackstands (Item 1) [Figure 10-10-1] under the frame at the front of the utility vehicle (both sides).

NOTE: When lifting the utility vehicle, place the jack under front frame [Figure 10-10-1].

Figure 10-10-2

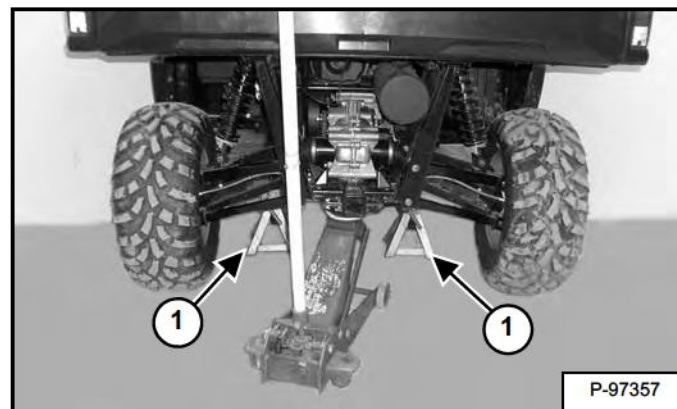

Place the jackstands (Item 1) [Figure 10-10-2] under the rear frame of the utility vehicle.

NOTE: When lifting the utility vehicle, place the jack under the rear frame [Figure 10-10-2].

ROLLOVER PROTECTIVE STRUCTURE (ROPS)

Description

Figure 10-20-1



The utility vehicle has a Rollover Protective Structure (ROPS) to provide protection from rollover [Figure 10-20-1]. The seat belt must be worn for rollover protection.

Check the ROPS, mounting, and hardware for damage. Never modify the ROPS. Replace the ROPS and hardware if damaged.

ROPS - Rollover Protective Structure per ISO 5700: 2006, SAE J2194: 2009, and OSHA 1928.53: 2006.



AVOID INJURY OR DEATH

Never modify ROPS by welding, grinding, drilling holes or adding attachments unless instructed to do so by Bobcat Company. Changes to the ROPS can cause loss of operator protection from rollover and result in injury or death.

W-2596-0510

Figure 10-20-2

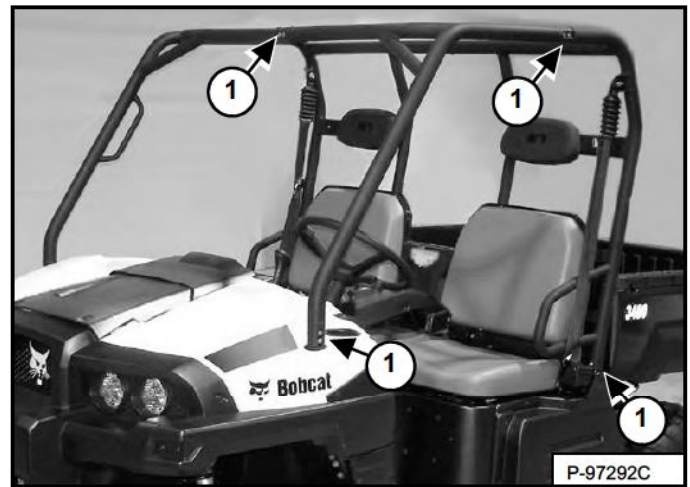

Make sure all ROPS mounting hardware [Figure 10-20-2] and [Figure 10-20-3] is tight.

The correct torque for ROPS tube to ROPS tube mounting hardware (Item 1) [Figure 10-20-2] is 34 - 38 N•m (25 - 28 ft-lb).

Figure 10-20-3



The correct torque for ROPS to frame mounting hardware (Item 1) [Figure 10-20-3] is 20 - 24 N•m (16 - 18 ft-lb).

Dealer Copy -- Not for Resale

TRANSPORTING THE UTILITY VEHICLE ON A TRAILER

Loading And Unloading

! WARNING

AVOID SERIOUS INJURY OR DEATH

Adequately designed ramps of sufficient strength are needed to support the weight of the machine when loading onto a transport vehicle. Wood ramps can break and cause personal injury.

W-2058-0807

Be sure the transport and towing vehicles are of adequate size and capacity for the weight of utility vehicle. (See Performance on Page SPEC-10-2.)

Figure 10-30-1



The utility vehicle can be loaded or unloaded forward or backward [Figure 10-30-1].

The rear of the trailer must be blocked or supported [Figure 10-30-1] when loading or unloading to prevent the front end of the trailer from raising up.

Figure 10-30-2

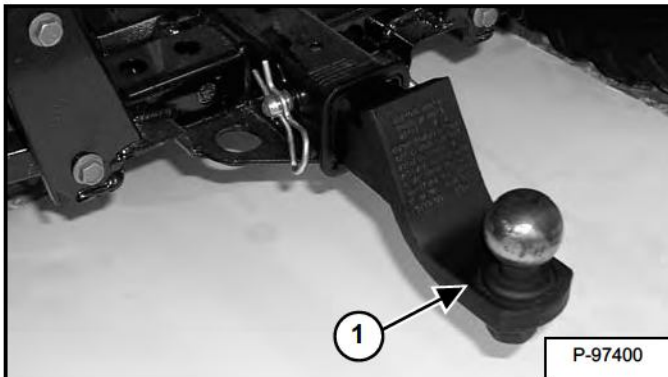

It may be necessary to remove items installed in the receiver hitch (Item 1) [Figure 10-30-2] before loading or unloading to prevent them from hitting the ground.

Fastening

Use the following procedure to fasten the utility vehicle to the transport vehicle to prevent it from moving during turns, sudden stops or when going up and down slopes.

Put the gear selector in gear, engage the park brake, stop the engine and remove the key.

Figure 10-30-3

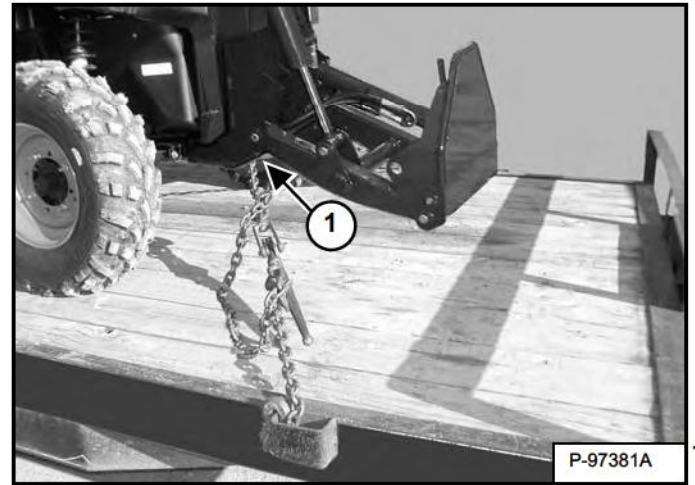

Fasten the front of utility vehicle using the attachment arm frame (Item 1) [Figure 10-30-3] (both sides).

Figure 10-30-4

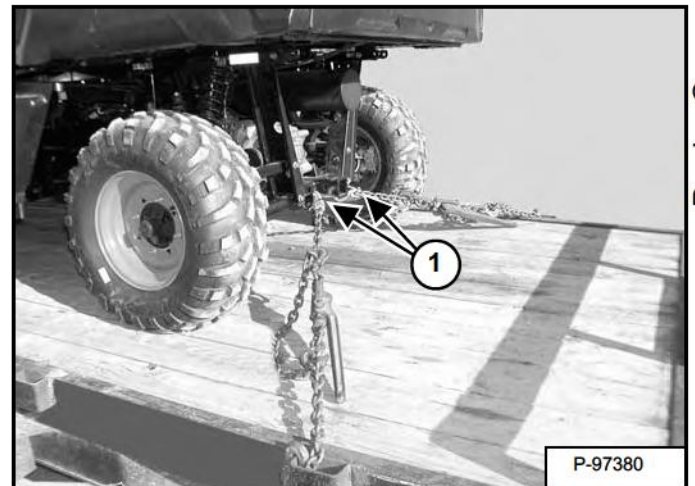

Fasten the rear of utility vehicle using the receiver hitch safety chain loops (Item 1) [Figure 10-30-4] as the tie down point.

Use chain binders to tighten the chains and then safely tie the chain binder levers to prevent loosening.

Dealer Copy -- Not for Resale

TOWING THE UTILITY VEHICLE

Procedure

The utility vehicle can be towed using the following procedure.

- Connect a strap or chain to the front tow loop for towing forward. Connect the strap or the chain to the receiver hitch to tow in the reverse direction. (Only tow for a short distance in the reverse direction.)
- Have an operator in the utility vehicle, with the seat belt fastened, for steering and applying the brakes while towing.
- Disengage the parking brake and place the gear selector in neutral.
- Tow vehicle at a slow speed.

The towing strap (chain or cable) must be rated at one and one-half times the weight of the utility vehicle. (See Performance on Page SPEC-10-2.)

SERVICE SCHEDULE

Chart

Maintenance work must be done at regular intervals. Failure to do so will result in excessive wear and early failures. The service schedule is a guide for correct maintenance of the Bobcat product.



Instructions are necessary before operating or servicing the utility vehicle. Read and understand the Operation & Maintenance Manual and signs (decals) on the utility vehicle. Follow warnings and instructions in the manuals when making repairs, adjustments or servicing. Check for correct function after adjustments, repairs or service. Untrained operators and failure to follow instructions can cause injury or death.

W-2859-0510

SERVICE SCHEDULE		HOURS				
ITEM	SERVICE REQUIRED	DAILY	10	25	100	200
Brake Fluid, Fuel, Engine Oil, Coolant and Hydraulic Fluid	Check the levels and add as needed.	[4]				
Brake System and Pedal Travel	Ensure proper operation.	[4]				
Throttle	Ensure proper operation.					
Tires	Check wear, damage and correct air pressure.	[4]				
ROPS and Seat Belt	Check the condition of the ROPS and mounting hardware. Check the condition of seat belts. Clean or replace seat belt retractors as needed.					
Front and Rear Suspension and Steering	Inspect for broken parts, loose hardware and free operation.	[4]				
Safety Signs (Decals)	Check for damaged or missing signs (decals). Replace any signs that are damaged or missing.					
Frame Fasteners	Inspect and ensure tightness.					
Head Lights, Tail Lights, Indicator Lights and Switches	Check for proper operation and apply dielectric grease when a lamp is replaced.					
Wheel Nuts	Check for loose wheel nuts and tighten to correct torque. See TIRE MAINTENANCE in this Manual.	[8]				
Fuel Filter	Remove the trapped water.					
Engine Air Filter And Pre-Filter	Inspect, clean and replace as needed.		[4] [5]			
Battery	Check cables, connections, clean and test.					
Front And Rear Differential Lubricant	Check lubricant level; add as needed.			[2] [4]		
Transmission Lubricant	Check lubricant level; add as needed.			[2] [4]		
Brake Pad And Parking Brake Pad Wear	Inspect. Replace if necessary.				[4]	
Shift Linkage	Inspect, lubricate and adjust.					
Prop Shaft Yoke And Attachment Arm	Grease prop shaft yoke fitting(s) (3 pumps maximum) and attachment arm and cylinder fittings.				[4]	
Throttle Cable And Throttle Pedal	Inspect for damage. Adjust or replace if necessary.			[5]		
Air Intake System	Inspect all air intake lines for leaks and repair if necessary.			[5]		
Park Brake Cable Tension	Check tension and adjust if necessary.				[6]	
Fuel System	Check for leaks at tank cap, lines and fuel pump.				[7]	
Radiator	Check for leaks and clean external surfaces.					
Cooling Hoses, Engine Mounts, Exhaust Pipe and Muffler	Inspect for damage or leaks (if applicable) Replace components if necessary.					
Engine Oil and Filter	Replace oil and filter. Clean oil tank screen. See specification section for proper oil requirements.			[1]	[4]	
Wiring	Inspect for wear and routing. Apply dielectric grease to connectors subjected to water, mud, etc.					
Clutches, (Drive and Driven) and Drive Belt	Inspect for damage or wear. Clean clutches and replace worn parts.				[4]	
Front and Rear Suspension and Steering	Inspect for steering freeplay and suspension wear.				[4]	
Front Wheel Bearings	Inspect. Replace as needed.					
Fuel Filter	Replace filter element.					
Alternator / Fan / Water Pump Belt	Check belt tension and adjust or replace as needed.					[1]
Toe Adjust	Inspect front axle toe adjustment. Adjust if necessary and when parts are replaced.					
Brake Fluid	Replace the fluid.					[3]
Cooling System	Test coolant strength and pressure test system.					Every year
Coolant	Replace the coolant					Every two years
Spark Arrester Muffler	Empty Spark Chamber.					Every 300 Hours or 3 years
Engine Valves	Adjust the engine valves. See your Bobcat dealer for this service.					1000 Hours
Engine Breather System	Inspect crankcase breather system. See your Bobcat dealer for this service.					1500 Hours

- [1] Perform first service at 50 hours; then as scheduled.
- [2] Change yearly.
- [3] Change as scheduled or every 2 years (whichever comes first).
- [4] Perform these procedure more often for vehicles subjected to severe use.
- [5] Emission Control System Service.
- [6] Adjust after the first 25 hours of operation.
- [7] Replace fuel hoses every 2 years.
- [8] The wheel nuts must be checked and torqued after the first eight hours of operation of a new machine and after the first eight hours of operation when wheel(s) have been removed for service.

Dealer Copy -- Not for Resale

AIR CLEANER SERVICE

Pre-Filter Element

For the correct service interval of the pre-filter element (See SERVICE SCHEDULE on Page 10-50-1.)

The intake air pre-filter is located under the front cover. The pre-filter traps larger particles before the air reaches the main engine air filter.

Removal

Figure 10-60-1

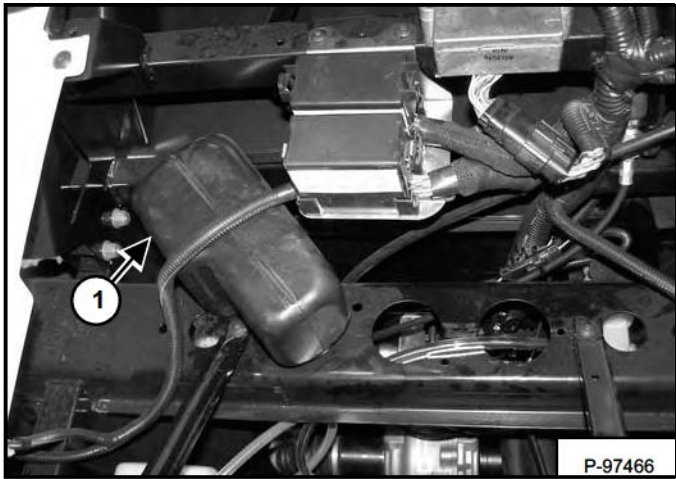

Remove the front cover.

The pre-filter box (Item 1) [Figure 10-60-1] is connected to a rubber hose so the box can be relocated to access the element.

Figure 10-60-2

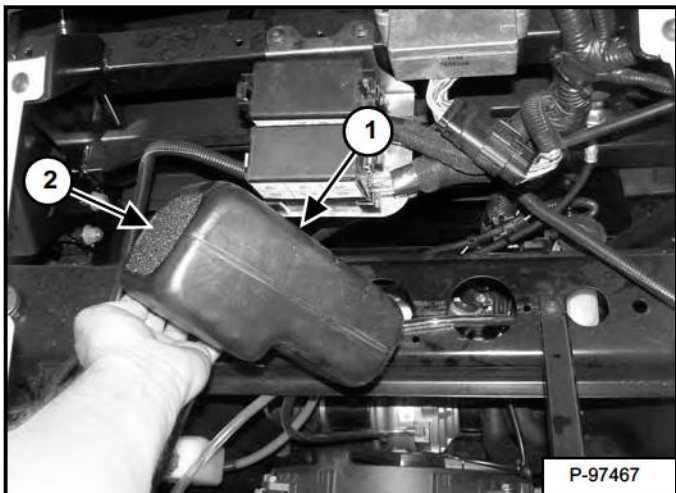

Rotate the pre-filter box (Item 1) back to access the pre-filter element (Item 2) [Figure 10-60-2] for removal.

Figure 10-60-3

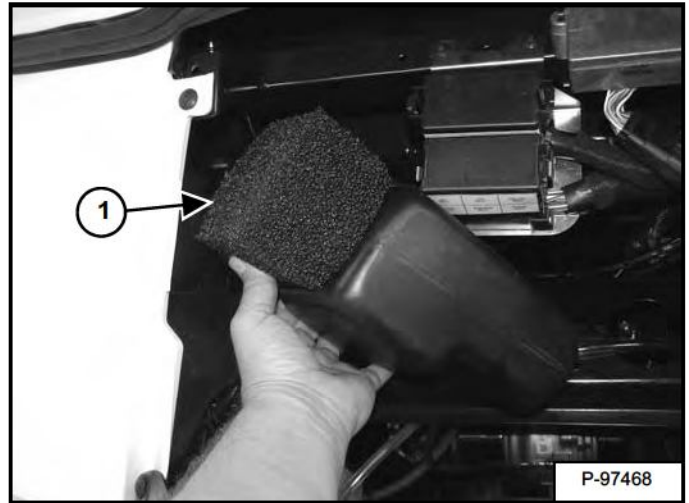

NOTE: The fiber pre-filter element must be gently removed from the box to avoid tearing or damaging the element. Inspect the element for damage. If any damage is found, replace the element.

Reach into the pre-filter box and squeeze the pre-filter element (Item 1) [Figure 10-60-3] to collapse it to aid in removal.

DO NOT use compressed air to clean the pre-filter box. Use a clean damp cloth and wipe out the inside of the box.

Cleaning Element

If the element is dirty, clean it with a high flash point solvent, followed by hot soapy water. Rinse and dry the filter element thoroughly. Inspect element for tears or damage. Replace if necessary.

Installation

Squeeze the pre-filter element (Item 1) [Figure 10-60-3] and insert into the box. Make sure the element is properly installed so that it fits snugly back into the box.

Reposition the pre-filter box (Item 1) [Figure 10-60-1] back to its original location.

Reinstall the front cover.

Dealer Copy -- Not for Resale

AIR CLEANER SERVICE (CON'D)

Replacing Filter Element

Raise the cargo box.

For the correct service interval of the air cleaner (See SERVICE SCHEDULE on Page 10-50-1.)

Check the air intake hose, the filter element and the air cleaner housing for cracks, tears or damage. Check to make sure all connections are tight.

Figure 10-60-4

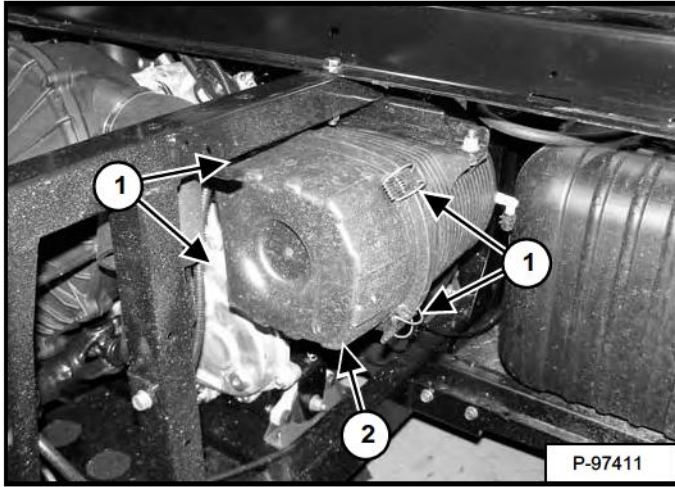

Open the four retaining clamps (Item 1) and remove the cover (Item 2) [Figure 10-60-4].

Figure 10-60-5

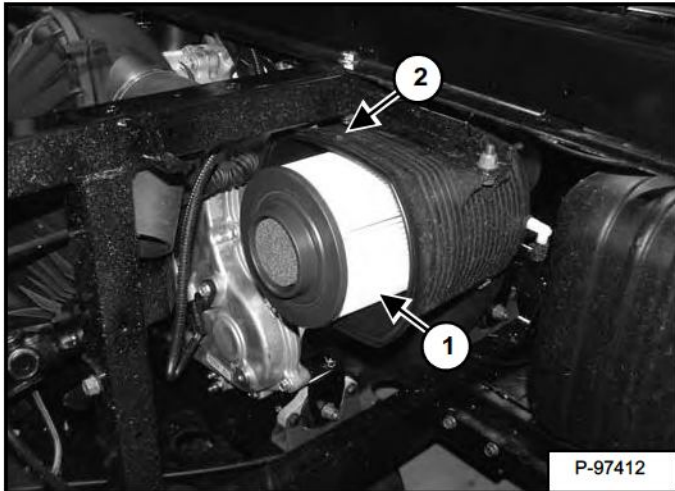

Rotate the element to aid in removing the filter element (Item 1) [Figure 10-60-5].

Clean the inside of the filter housing. (Do not use compressed air.)

Figure 10-60-6

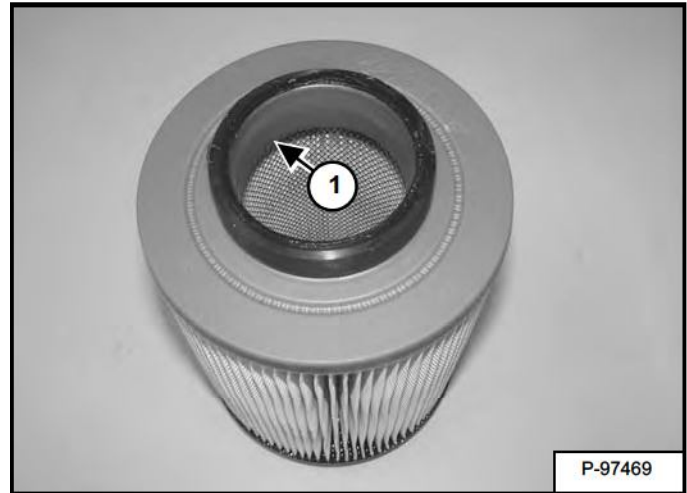

NOTE: Apply a small amount of general purpose grease to the inner sealing surface (Item 1) [Figure 10-60-6] of the filter to aid in installing.

Install the new filter element (Item 1) [Figure 10-60-5] until fully seated.

Figure 10-60-7

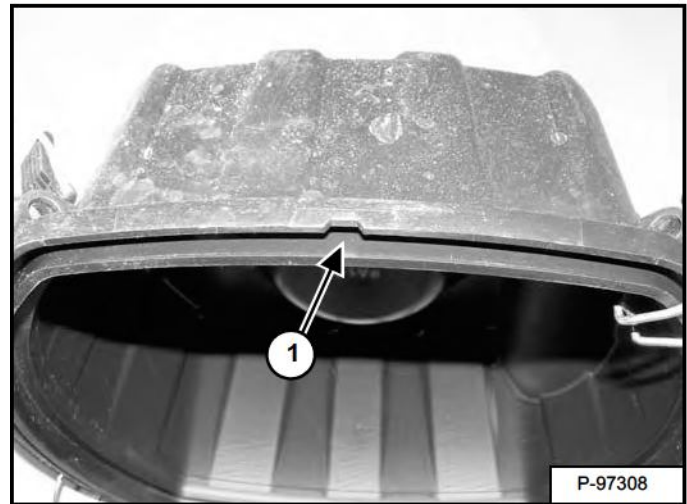

NOTE: There is a small notch (Item 1) [Figure 10-60-7] that locates the cover correctly on the filter housing. Make sure the notch in the cover matches the tab (Item 2) [Figure 10-60-5] on the housing when reinstalling the cover.

Locate the notch on the cover (Item 1) [Figure 10-60-7] with the tab (Item 2) [Figure 10-60-5] on the housing and install the cover.

Secure the cover (Item 2) with the four retaining clamps (Item 1) [Figure 10-60-4].

ENGINE COOLING SYSTEM

Checking Level

Follow the service interval for checking the coolant level. (See SERVICE SCHEDULE on Page 10-50-1.)

! WARNING

AVOID INJURY

Stop the engine and allow to cool before adding coolant or you can be burned.

W-2106-0907

Figure 10-70-1

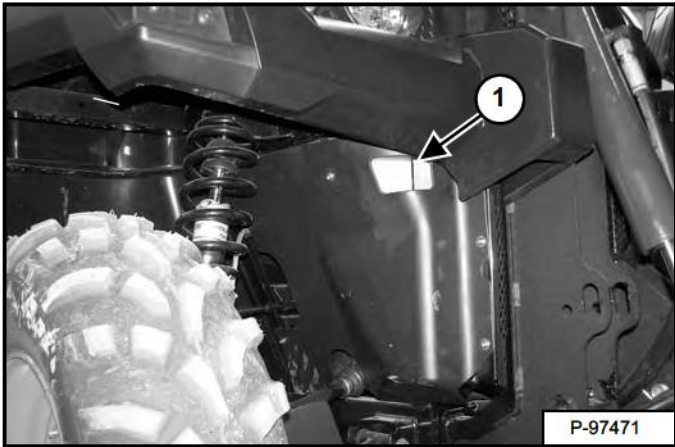

The coolant recovery tank is located under the front cover. The coolant level can be visually checked by looking through an access hole (Item 1) [Figure 10-70-1] in the right front corner of the utility vehicle.

Figure 10-70-2

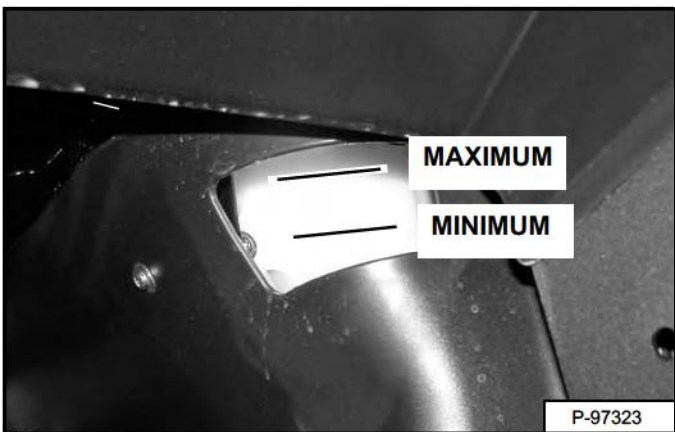

The coolant level in the recovery tank must be between the marks on the tank when the engine is cool [Figure 10-70-2]. (Illuminate the back side of the recovery tank with a flash light to see the fluid level easier.)

NOTE: The cooling system is factory filled with ethylene glycol coolant (green color). **DO NOT** mix ethylene glycol with propylene glycol.

IMPORTANT

AVOID ENGINE DAMAGE

Always use the correct ratio of water to antifreeze.

Too much antifreeze reduces cooling system efficiency and may cause serious premature engine damage.

Too little antifreeze reduces the additives which protect the internal engine components; reduces the boiling point and freeze protection of the system.

Always add a premixed solution. Adding full strength concentrated coolant can cause serious premature engine damage.

I-2124-0497

Ethylene Glycol

! WARNING

AVOID BURNS

Do not remove radiator cap when the engine is hot. You can be seriously burned.

W-2070-1203

Mix new coolant in a separate container. (See Fluid And Capacities on Page -150.)

The correct mixture of coolant to provide a -37°C (-34°F) freeze protection is 4 L ethylene glycol mixed with 4 L of water **OR** 1 U.S. gal ethylene glycol mixed with 1 U.S. gal of water.

Add premixed coolant, 50% water and 50% ethylene glycol to the coolant recovery tank until the coolant level reaches the lower marker on the tank [Figure 10-70-2]. (Mixture of up to 60% ethylene glycol 40% water is acceptable.)

Use a refractometer to check the condition of ethylene glycol in your cooling system.

Dealer Copy -- Not for Resale

ENGINE COOLING SYSTEM (CONT'D)

Cleaning

! WARNING

AVOID INJURY

Use safety goggles when using air or water under pressure. Do not use cold water to clean a hot engine.

W-2064-0907

Check the cooling system every day to prevent overheating, loss of performance or engine damage.

Do not obstruct or deflect air flow through the radiator by installing unauthorized accessories in front of the radiator or behind the cooling fan. Interference with the radiator air flow can lead to overheating and consequent engine damage.

IMPORTANT

Do not use a pressure washer to clean the radiator. High pressure can damage the fins.

I-2318-0710

Figure 10-70-3

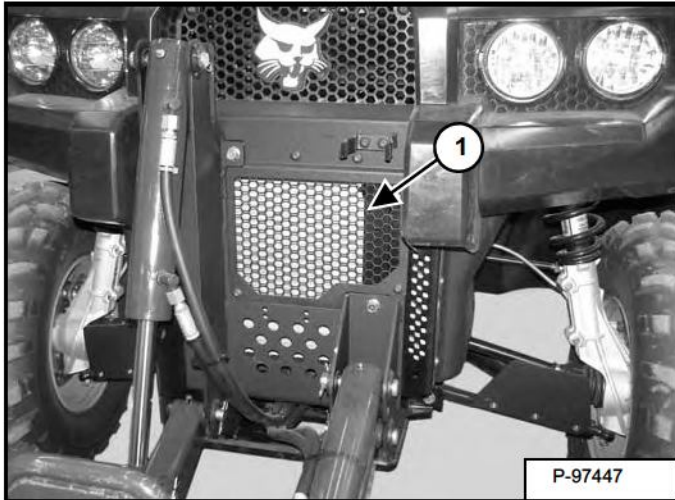
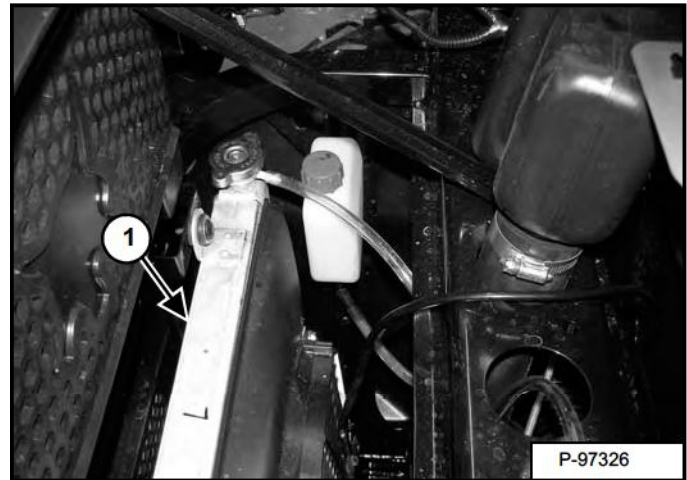

Figure 10-70-4



Remove the front cover.

Use low air or water pressure to remove debris in the area of the radiator (Item 1) [Figure 10-70-3] and (Item 1) [Figure 10-70-4].

Check the cooling system for leaks.

Reinstall the front cover.

ENGINE COOLING SYSTEM (CONT'D)

Removing And Replacing Coolant

Follow the service interval for replacing the coolant. (See SERVICE SCHEDULE on Page 10-50-1.)

Remove the front cover.

! WARNING

AVOID INJURY

Stop the engine and allow to cool before adding coolant or you can be burned.

W-2106-0907

! WARNING

AVOID BURNS

Do not remove radiator cap when the engine is hot. You can be seriously burned.

W-2070-1203

Figure 10-70-5

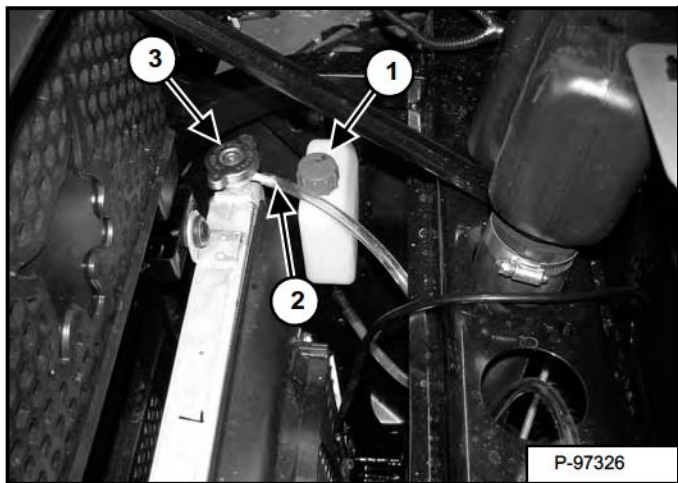

Remove the cap (Item 1) [Figure 10-70-5] from the coolant recovery tank.

Remove the hose (Item 2) [Figure 10-70-5] from the coolant recovery tank where it attaches to the radiator. Drain the coolant into a container.

Reconnect the hose (Item 2) [Figure 10-70-5].

Open the radiator cap (Item 3) [Figure 10-70-5].

Figure 10-70-6

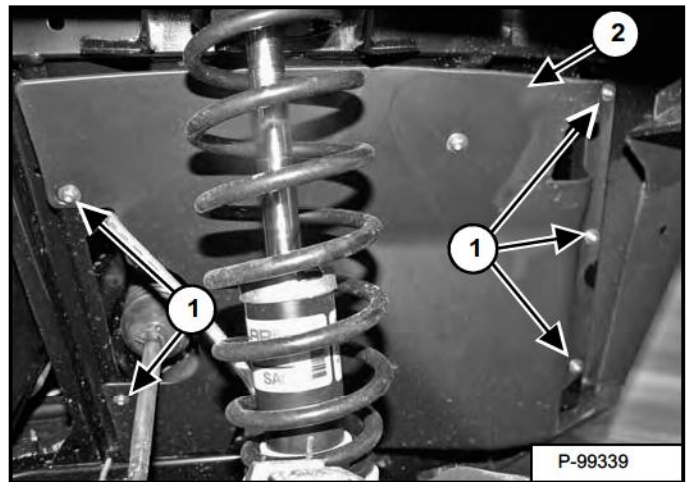

Remove the five bolts (Item 1) and remove the right front inner fender panel (Item 2) [Figure 10-70-6].

Figure 10-70-7

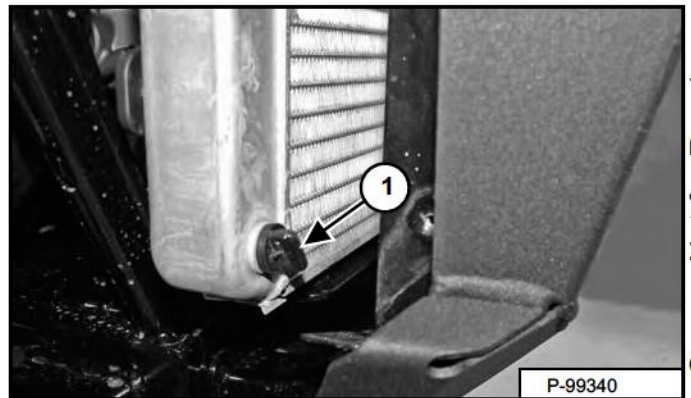

At the bottom right corner of the radiator, open the drain valve (Item 1) [Figure 10-70-7] and drain the coolant into a container.

Close the drain valve.

Dispose of the used coolant in an environmentally safe manner.

Add premixed coolant to the coolant radiator until it is full. Install the cap (Item 3) [Figure 10-70-5].

Add premixed coolant to the coolant recovery tank until it is at the full mark. Install the cap (Item 1) [Figure 10-70-5].

Dealer Copy -- Not for Resale

ENGINE COOLING SYSTEM (CONT'D)

Removing And Replacing Coolant (Cont'd)

WARNING

**HOT PRESSURIZED FLUID CAN CAUSE
SERIOUS BURNS**

- Never open hot.
- OPEN SLOWLY.

W-2755-0908

Figure 10-70-8

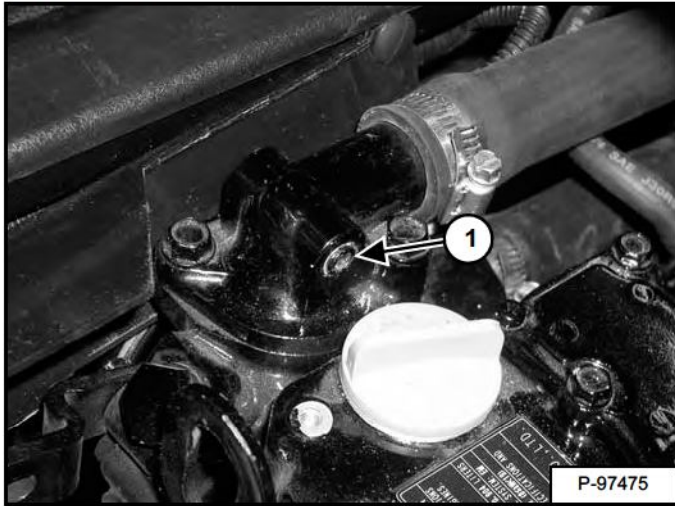

To bleed air from the cooling system, do the following:

Remove the seat. (See Seat Base Removal And Installation on Page 30-20-1.)

Put the transmission in neutral, engage the parking brake and start the engine.

At the rear of the engine thermostat housing, slowly loosen the plug (Item 1) [Figure 10-70-8] (Do not remove the plug, just loosen the plug) and allow any air to escape by the plug threads. When coolant, free of air bubbles is visible, tighten the plug.

Stop the engine and check the coolant level. Add premixed coolant to the recovery tank as needed.

Reinstall the right panel, the front cover and the seat.

NOTE: Some coolant level drop is normal after the coolant system has been drained and refilled. The system will need to purge any air that was trapped in the system. Observe the coolant levels and maintain as recommended by adding coolant to recovery tank.

FUEL SYSTEM

Fuel Specifications

Use only clean, high quality diesel fuel, Grade No. 2 or Grade No. 1.

The following is one suggested blending guideline which should prevent fuel gelling during cold temperatures:

TEMPERATURE C° (F°)	NO. 2	NO. 1
-9° (+15°)	100%	0%
Down to -29° (-20°)	50%	50%
Below -29° (-20°)	0%	100%

The following fuels may be used in this machine:

- Low Sulfur (500 ppm sulfur) Diesel Fuel.
- Ultra Low Sulfur (15 ppm sulfur) Diesel Fuel.
- Biodiesel Blend Fuel - Must contain no more than five percent biodiesel mixed with low sulfur or ultra low sulfur petroleum based diesel. This is commonly marketed as B5 blended diesel fuel. B5 blended diesel fuel must meet ASTM D975 (US Standard) or EN590 (EU Standard) specifications.

Biodiesel Blend Fuel

Biodiesel blend fuel has unique qualities that should be considered before using in this machine:

- Cold weather conditions can lead to plugged fuel system components and hard starting.
- Biodiesel blend fuel is an excellent medium for microbial growth and contamination which can cause corrosion and plugging of fuel system components.
- Use of biodiesel blend fuel may result in premature failure of fuel system components, such as plugged fuel filters and deteriorated fuel lines.
- Shorter maintenance intervals may be required, such as cleaning the fuel system and replacing fuel filters and fuel lines.
- Using biodiesel blended fuels containing more than five percent biodiesel can affect engine life and cause deterioration of hoses, tubelines, injectors, injector pump and seals.

Apply the following guidelines if biodiesel blend fuel is used:

- Ensure the fuel tank is as full as possible at all times to prevent moisture from collecting in the fuel tank.
- Ensure that the fuel tank cap is securely tightened.
- Biodiesel blend fuel can damage painted surfaces, remove all spilled fuel from painted surfaces immediately.
- Drain all water from the fuel filter daily before operating the machine.
- Do not exceed engine oil change interval. Extended oil change intervals can cause engine damage.
- Before vehicle storage; drain the fuel tank, refill with 100% petroleum diesel fuel, add fuel stabilizer and run the engine for at least 30 minutes.

NOTE: Biodiesel blend fuel does not have long term stability and should not be stored for more than three months.

Dealer Copy -- Not for Resale

FUEL SYSTEM (CONT'D)

Filling The Fuel Tank

! WARNING

AVOID INJURY OR DEATH

Stop and cool the engine before adding fuel. **NO SMOKING!** Failure to obey warnings can cause an explosion or fire.

W-2063-0807

Figure 10-80-1



Remove the fill cap (Item 1) [Figure 10-80-1].

Use a clean, approved safety container to add fuel of the correct specification. Add fuel only in an area that has free movement of air and no open flames or sparks. **NO SMOKING!**

Install and tighten the fuel cap (Item 1) [Figure 10-80-1].

Fuel Filter

Remove water from, or replace the fuel filter at the correct interval. (See SERVICE SCHEDULE on Page 10-50-1.)

Figure 10-80-2

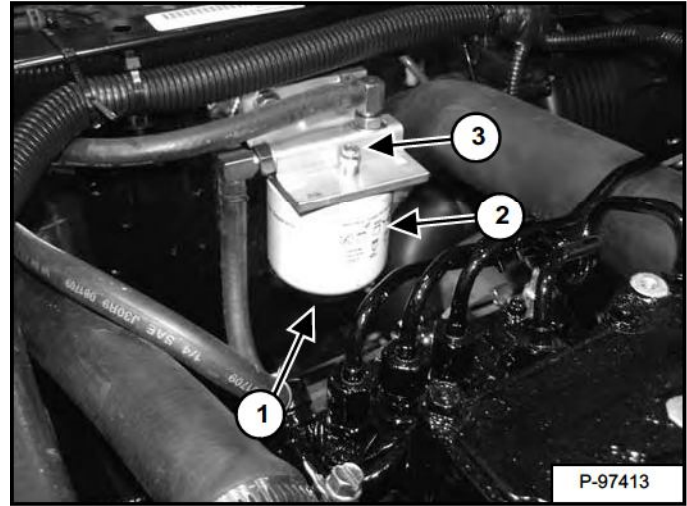

Removing Water:

The fuel filter is located under the seat, on the right side of the engine. (See Seat Base Removal And Installation on Page 30-20-1.)

Loosen the drain (Item 1) [Figure 10-80-2] at the bottom of the filter element to remove water from the filter. Close the drain.

Replacing Element:

Remove the filter element (Item 2) [Figure 10-80-2].

NOTE: Be sure the filter gasket is removed with the old fuel filter.

Clean the area around the filter housing.

Put clean oil on the seal of the new filter element.

Install the fuel filter, and hand tighten until the gasket contacts the surface, then an additional 1/2 - 3/4 turn.

Remove air from the fuel system. (See Removing Air From The Fuel System on Page 10-80-3.)



Suggest:

If the above button click is invalid.

Please download this document

first, and then click the above link

to download the complete manual.

Thank you so much for reading

FUEL SYSTEM (CONT'D)

Removing Air From The Fuel System



AVOID INJURY OR DEATH

Always clean up spilled fuel or oil. Keep heat, flames, sparks or lighted tobacco away from fuel and oil. Failure to use care around combustibles can cause explosion or fire.

W-2103-0508

After replacing the filter element or when the fuel tank has run out of fuel, air must be removed from the fuel system before starting the engine.

Be sure the engine is cool.

Remove the seat. (See Seat Base Removal And Installation on Page 30-20-1.)

Figure 10-80-3

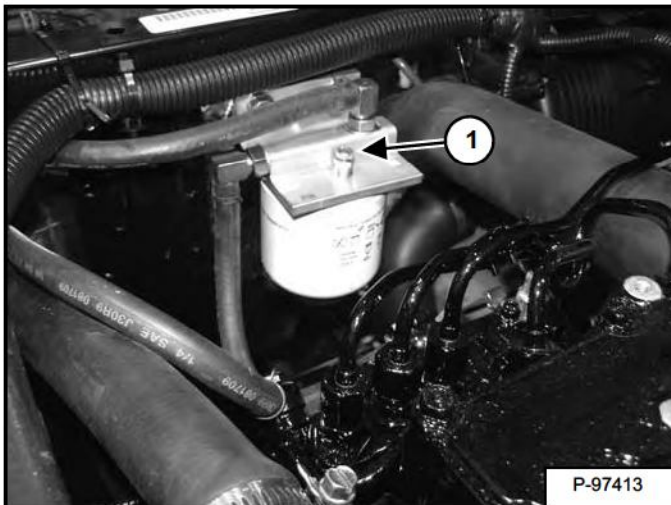

With the park brake engage and the gear selector lever in neutral, turn the key to the ON position. Do Not start the engine.

The fuel pump will start pumping fuel with the key in the ON position (10 -15 seconds) and will force air out of the fuel system.

At times it may be necessary to open the valve (Item 1) [Figure 10-80-3] on the fuel filter housing until fuel comes from the valve with no air bubbles.

Start the engine.

Repeat until the engine starts.

Filling A Portable Fuel Container

Static electric spark can explosively ignite gasoline vapors when filling ungrounded portable containers.

Always put the container **ON THE GROUND** before filling.

Keep the nozzle in contact with container while filling.

NEVER fill container in the cargo box or on the utility vehicle.



FIRE AND EXPLOSION CAN CAUSE SERIOUS INJURY OR DEATH

Static electric spark can explosively ignite gasoline vapors when filling ungrounded portable containers.

- **ALWAYS** place the container **ON THE GROUND** before filling.
- Keep the nozzle in contact with container while filling.
- **NEVER** fill container in the cargo box, storage bins or on the machine.

W-2801-0709

Dealer Copy -- Not for Resale

<https://www.ebooklibonline.com>

Hello dear friend!

Thank you very much for reading.

Enter the link into your browser.

The full manual is available for immediate download.

<https://www.ebooklibonline.com>