



---

# Service Manual

## 3400, 3400XL Utility Vehicle

---

**S/N B3FK11001 & Above**  
**S/N B3FK17001 & Above**  
**S/N B3FM11001 & Above**  
**S/N B3FM17001 & Above**

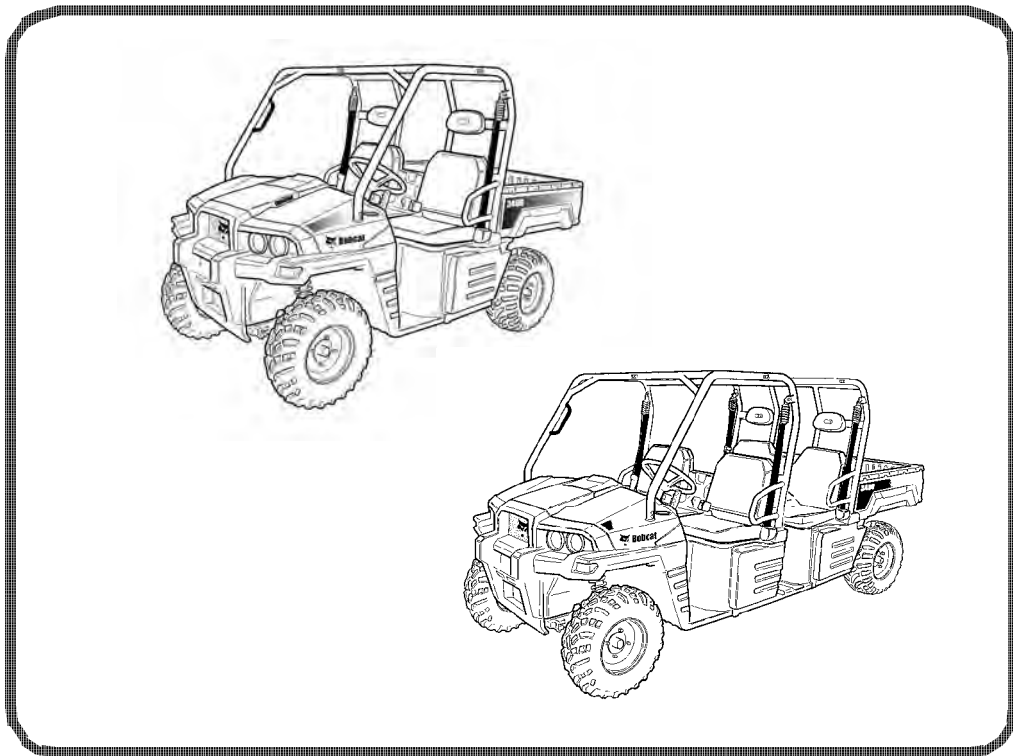

Dealer Copy -- Not for Resale



# MAINTENANCE SAFETY



## WARNING

Instructions are necessary before operating or servicing the utility vehicle. Read and understand the Operation & Maintenance Manual and signs (decals) on utility vehicle. Follow warnings and instructions in the manuals when making repairs, adjustments or servicing. Check for correct function after adjustments, repairs or service. Untrained operators and failure to follow instructions can cause injury or death.

W-2859-0510



**Safety Alert Symbol:** This symbol with a warning statement, means: "Warning, be alert! Your safety is involved!" Carefully read the message that follows.

### CORRECT

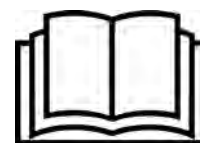

P-90216

⚠ Never service the utility vehicle without instructions.

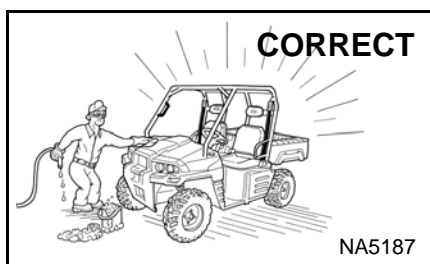

NA5187

⚠ Cleaning and maintenance are required daily.

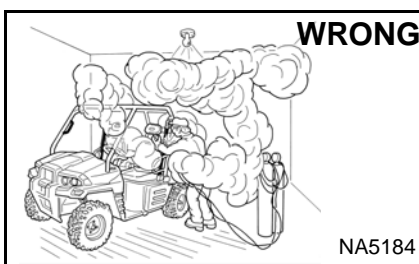

NA5184

⚠ Have good ventilation when welding or grinding painted parts.  
 ⚠ Wear dust mask when grinding painted parts. Toxic dust and gas can be produced.  
 ⚠ Avoid exhaust fume leaks which can kill without warning. Exhaust system must be tightly sealed.

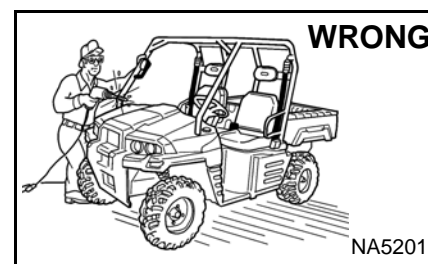

NA5201

⚠ Never modify equipment or add attachments and accessories not approved by Bobcat Company.

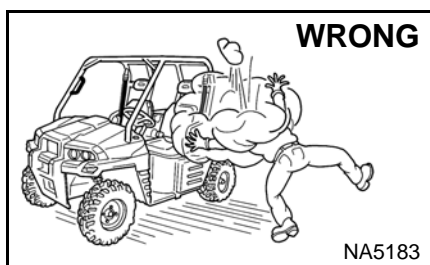

NA5183

⚠ Stop, cool and clean engine of flammable materials before checking fluids.  
 ⚠ Never service or adjust utility vehicle with the engine running unless instructed to do so in the manual.  
 ⚠ Never fill fuel tank with engine running, while smoking or when near open flame.

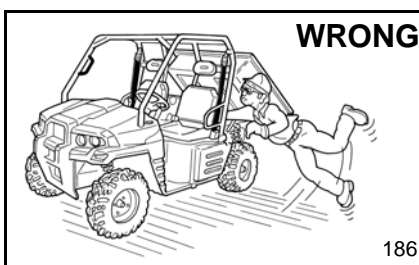

186

⚠ Keep body, jewelry and clothing away from moving parts, electrical contact, hot parts and exhaust.  
 ⚠ Wear eye protection to guard from battery acid, compressed springs, fluids under pressure and flying debris when engines are running or tools are used. Use eye protection approved for type of welding.  
 ⚠ Keep access doors closed except for service.



B-6589

⚠ Lead-acid batteries produce flammable and explosive gases.  
 ⚠ Keep arcs, sparks, flames and lighted tobacco away from batteries.  
 ⚠ Batteries contain acid which burns eyes or skin on contact. Wear protective clothing. If acid contacts body, flush well with water. For eye contact, flush well and get immediate medical attention.

Maintenance procedures which are given in the Operation & Maintenance Manual can be performed by the owner/operator without any specific technical training. Maintenance procedures which are **not** in the Operation & Maintenance Manual must be performed **ONLY BY QUALIFIED BOBCAT SERVICE PERSONNEL**. Always use **genuine Bobcat replacement parts**.

MSW41-0510

## CONTENTS

SAFETY & MAINTENANCE .....	10-01
DRIVE SYSTEM .....	20-01
MAINFRAME .....	30-01
ELECTRICAL SYSTEM & ANALYSIS .....	40-01
ENGINE SERVICE .....	50-01
SPECIFICATIONS .....	SPEC-01
ALPHABETICAL INDEX .....	INDEX-01

**<https://www.ebooklibonline.com>**

Hello dear friend!

Thank you very much for reading.

Enter the link into your browser.

The full manual is available for immediate download.

**<https://www.ebooklibonline.com>**

## FOREWORD

FOREWORD .....	1-7
SAFETY INSTRUCTIONS .....	1-9
FIRE PREVENTION .....	1-11
Maintenance .....	1-11
Operation .....	1-11
Electrical .....	1-11
Fueling .....	1-11
Starting .....	1-11
Spark Arrester Exhaust System .....	1-11
Welding And Grinding .....	1-11
Fire Extinguishers .....	1-12
SERIAL NUMBER LOCATIONS .....	1-13
Utility Vehicle Serial Number .....	1-13
Engine Serial Number .....	1-13
DELIVERY REPORT .....	1-14
UTILITY VEHICLE IDENTIFICATION (3400) .....	1-15
UTILITY VEHICLE IDENTIFICATION (3400XL) .....	1-16

# FOREWORD

This manual is for the Utility Vehicle mechanic. It provides necessary servicing and adjustment procedures for the Utility Vehicle and its component parts and systems. Refer to the for operating instructions, starting procedure, daily checks, etc.

A general inspection of the following items must be made after the Vehicle has had service or repair:

1. Check that the ROPS is in good condition and is not modified.



2. Check that ROPS mounting hardware is tightened and is Bobcat approved.

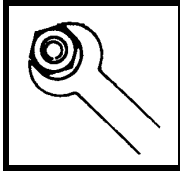

3. The operator and passenger seat belts must be correctly installed, functional and in good condition.

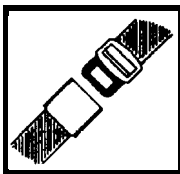

4. Safety signs (decals) must be legible and in the correct location.

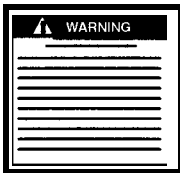

5. Foot pedals must return to neutral.

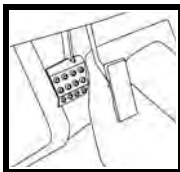

6. Check for correct function of the head lights and tail lights.



7. The parking brake must function correctly.

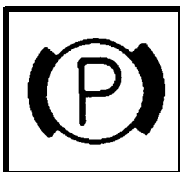

8. RapidLink™ must function correctly and be in good condition (3450 only).

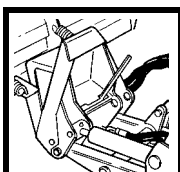

9. Check for correct function of indicator lamps.

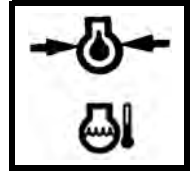

10. Check hydraulic fluid level, engine oil level and fuel supply (3450 only).

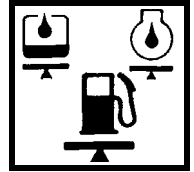

11. Inspect for fluid, oil or hydraulic fluid leaks (3450 only).

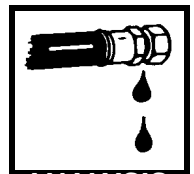

12. Lubricate the machine.



13. Check the condition of the battery and cables.

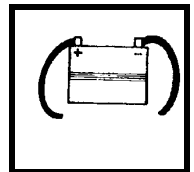

14. Inspect the air cleaner for damage or leaks. Check the condition of the element.

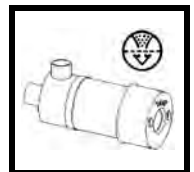

15. Check the electrical charging system.

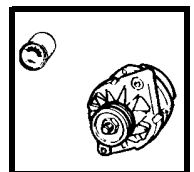

16. Check tires for wear and pressure. Use only approved tires.

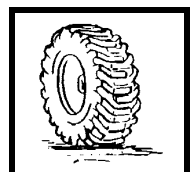

FW UV-0510 SM

17. Inspect for loose or broken parts or connections.



18. Check for any field modification not completed.



19. Operate the vehicle and check all functions.



20. Check for correct function of the Start Interlock System before the machine is returned to the customer.

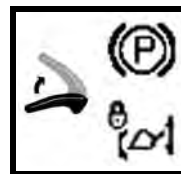

21. Check function or condition of all equipped options and accessories.



22. Recommend to the owner that all necessary corrections be made before the machine is returned to service.

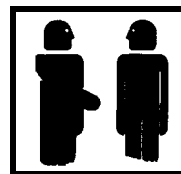

**CALIFORNIA  
PROPOSITION 65 WARNING**  
Diesel engine exhaust and some of its constituents are known to the state of California to cause cancer, birth defects and other reproductive harm.

## SAFETY INSTRUCTIONS



### Safety Alert Symbol

This symbol with a warning statement means: **“Warning, be alert! Your safety is involved!”** Carefully read the message that follows.



## WARNING

Operator must have instructions before operating the utility vehicle. Untrained operators can cause injury or death.

W-2855-0510

## IMPORTANT

This notice identifies procedures which must be followed to avoid damage to the utility vehicle.

I-2317-0510



## DANGER

The signal word **DANGER** on the utility vehicle and in the manuals indicates a hazardous situation which, if not avoided, will result in death or serious injury.

D-1022-0510



## WARNING

The signal word **WARNING** on the utility vehicle and in the manuals indicates a potentially hazardous situation which, if not avoided, could result in death or serious injury.

W-2856-0510

The following publications provide information on the safe use and maintenance of the Bobcat utility vehicle and attachments:

- The Delivery Report is used to assure that complete instructions have been given to the new owner and that the vehicle is in safe operating condition.
- The Operation & Maintenance Manual delivered with the vehicle or attachment contains operating information as well as routine maintenance and service procedures. It is a part of the vehicle and can be stored in a container provided on the vehicle. Replacement Operation & Maintenance Manuals can be ordered from your Bobcat dealer.
- Safety signs (decals) instruct on the safe operation and care of your Bobcat utility vehicle or attachment. The signs and their locations are shown in the Operation & Maintenance Manual. Replacement signs are available from your Bobcat dealer.
- An Operator's Handbook fastened to the operator cab. It's brief instructions are convenient to the operator. The handbook is available from your dealer in an English edition or one of many other languages. See your Bobcat dealer for more information on translated versions.
- The Service Manual and Parts Manual are available from your dealer for use by mechanics to do shop-type service and repair work.
- The Utility Vehicle Operator Training Course is available through your local dealer or at [www.training.bobcat.com](http://www.training.bobcat.com) or [www.bobcat.com](http://www.bobcat.com). This course is intended to provide rules and practices of correct operation of the utility vehicle. The course is available in English and Spanish versions.
- The Utility Vehicle Safety Video is available from your Bobcat dealer or at [www.training.bobcat.com](http://www.training.bobcat.com) or [www.bobcat.com](http://www.bobcat.com).

SI UV-0913 SM

## FIRE PREVENTION



### Maintenance

The utility vehicle and some attachments and accessories have components that are at high temperatures under normal operating conditions. The primary source of high temperatures is the engine and exhaust system. The electrical system, if damaged or incorrectly maintained, can be a source of arcs or sparks.

Flammable debris (leaves, straw, etc.) must be removed regularly. If flammable debris is allowed to accumulate, it can cause a fire hazard. Clean often to avoid this accumulation. Flammable debris in the engine compartment is a potential fire hazard.

The operator's area, engine compartment and engine cooling system must be inspected every day and cleaned if necessary to prevent fire hazards and overheating.

All fuels, most lubricants and some coolants mixtures are flammable. Flammable fluids that are leaking or spilled onto hot surfaces or onto electrical components can cause a fire.

### Operation

Do not use the utility vehicle where exhaust, arcs, sparks or hot components can contact flammable material, explosive dust or gases. Do not park this vehicle near open flames or pilot lights.

### Electrical



Check all electrical wiring and connections for damage. Keep the battery terminals clean and tight. Repair or replace any damaged part or wires that are loose or frayed.

Battery gas can explode and cause serious injury. Use the procedure in the Operation & Maintenance Manual for connecting the battery and for jump starting. Do not jump start or charge a frozen or damaged battery. Keep any open flames or sparks away from batteries. Do not smoke in battery charging area.

## Fueling



Stop the engine and let it cool before adding fuel. No smoking! Do not refuel a utility vehicle near open flames or sparks. Fill the fuel tank outdoors.

Ultra Low Sulfur Diesel (ULSD) poses a greater static ignition hazard than earlier diesel formulations with higher Sulfur content. Avoid death or serious injury from fire or explosion. Consult with your fuel or fuel system supplier to ensure the delivery system is in compliance with fueling standards for proper grounding and bonding practices.

### Starting

Use the procedure in the Operation & Maintenance Manual for connecting the battery and for jump starting.

### Spark Arrester Exhaust System

The spark arrester exhaust system is designed to control the emission of hot particles from the engine and exhaust system, but the muffler and the exhaust gases are still hot.

Check the spark arrester exhaust system regularly to make sure it is maintained and working properly. Use the procedure in the Operation & Maintenance Manual for cleaning the spark arrester muffler

### Welding And Grinding

Always clean the utility vehicle attachments and accessories, disconnect the battery, and disconnect the wiring from the Bobcat controllers before welding. Cover fuel tank, rubber hoses, battery and all other flammable parts. Keep a fire extinguisher near the utility vehicle when welding.

Have good ventilation when grinding or welding painted parts. Wear dust mask when grinding painted parts. Toxic dust or gas can be produced.

Dust generated from repairing nonmetallic parts such as hoods, fenders or covers can be flammable or explosive. Repair such components in a well ventilated area away from open flames or sparks.

SI UV-0913 SM

## FIRE PREVENTION (CONT'D)

### Fire Extinguishers



Know where fire extinguishers and first aid kits are located and how to use them. Inspect the fire extinguisher and service the fire extinguisher regularly. Obey the recommendations on the instructions plate.

## SERIAL NUMBER LOCATIONS

Always use the serial number of the utility vehicle when requesting service information or when ordering parts. Early or later models (identification made by serial number) may use different parts, or it may be necessary to use a different procedure in doing a specific service operation.

### Utility Vehicle Serial Number

Figure 1

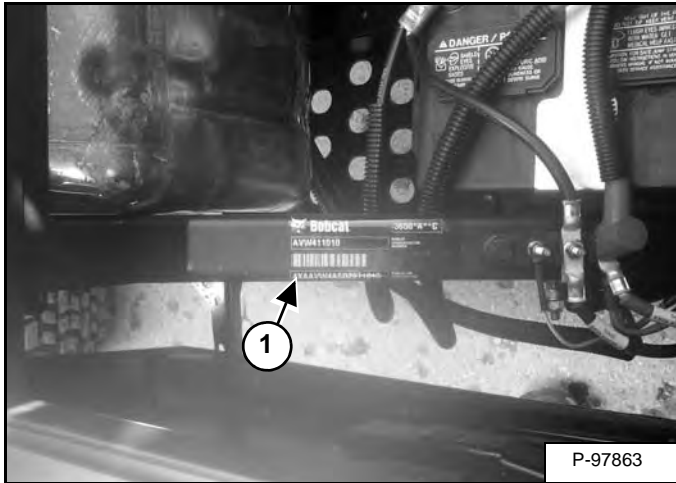

The utility vehicle serial number plate is located on the frame, under the passenger seat by the battery (Item 1) [Figure 1].

Figure 2

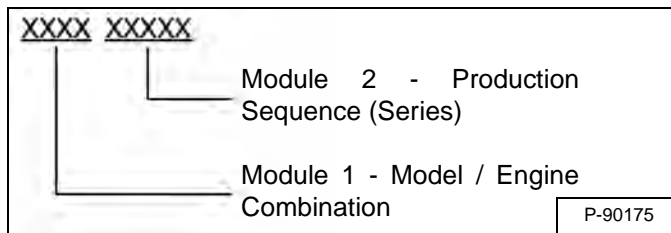

Explanation of utility vehicle Serial Number [Figure 2]:

1. The four digit Model / Engine Combination Module number identifies the model number and engine combination.
2. The five digit Production Sequence Number identifies the order which the utility vehicle is produced.

### Engine Serial Number

Figure 3

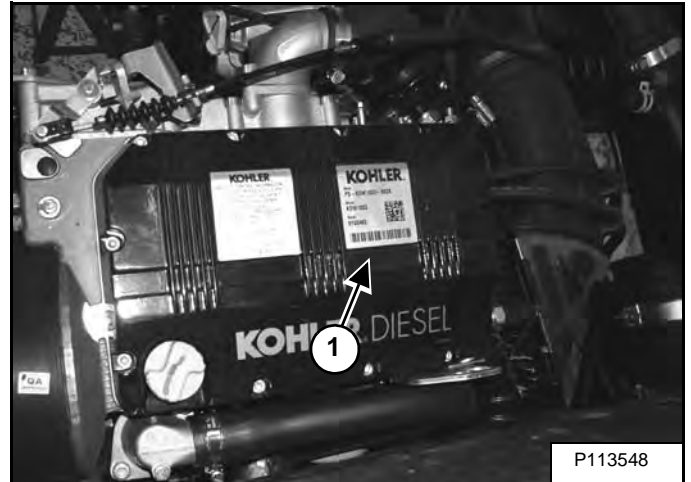

The engine serial number is located on top of the engine cover (Item 1) [Figure 3].

## DELIVERY REPORT

Figure 4

The diagram shows a form layout for a delivery report. At the top, there is a header area with the title "DELIVERY REPORT" and a list of items. Below this is a section with a "WARNING" header and another list of items. At the bottom, there is a final list of items. A small box in the bottom right corner contains the text "B-16315".

The delivery report **[Figure 4]** contains a list of items that must be explained or shown to the owner or operator by the dealer when the Bobcat utility vehicle is delivered.

The delivery report must be reviewed and signed by the owner or operator and the dealer.

UTILITY VEHICLE IDENTIFICATION (3400)

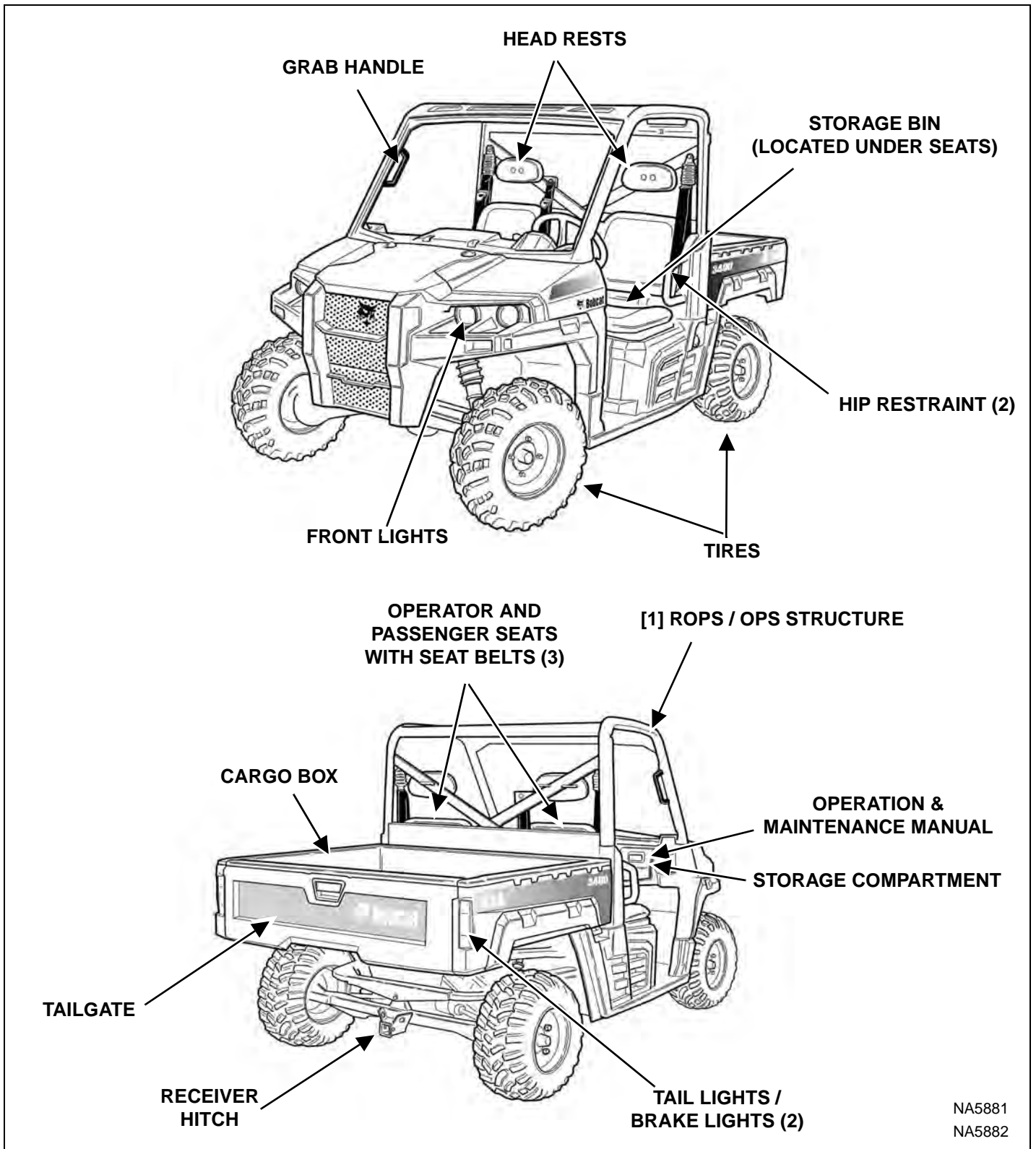

[1] ROPS - Roll-Over Protective Structure, per OSHA 1928.53: 2006.  
OPS - Occupant Protective Structure per ANSI/OPEI B71.9-2012.

UTILITY VEHICLE IDENTIFICATION (3400XL)

STORAGE BINS  
(LOCATED UNDER SEATS)

HEAD RESTS

GRAB HANDLE

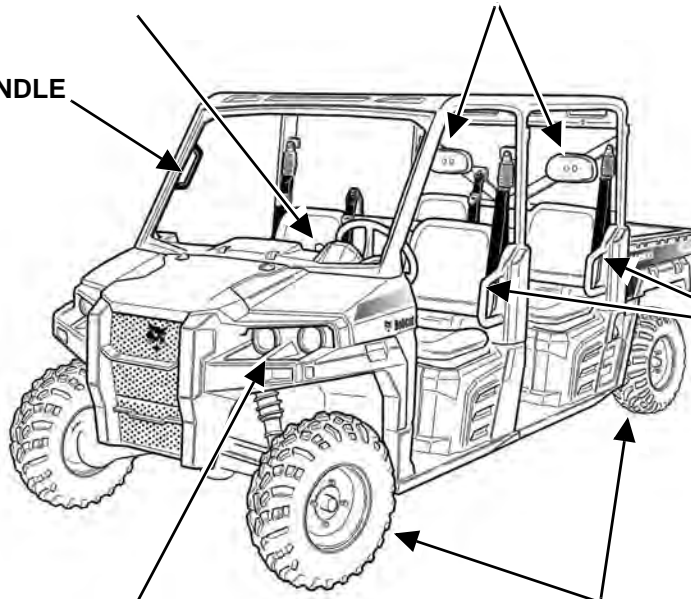

HIP RESTRAINT (4)

FRONT LIGHTS

TIRES

OPERATOR AND  
PASSENGER SEATS  
WITH SEAT BELTS

[1] ROPS / OPS STRUCTURE

CARGO BOX

OPERATION &  
MAINTENANCE MANUAL

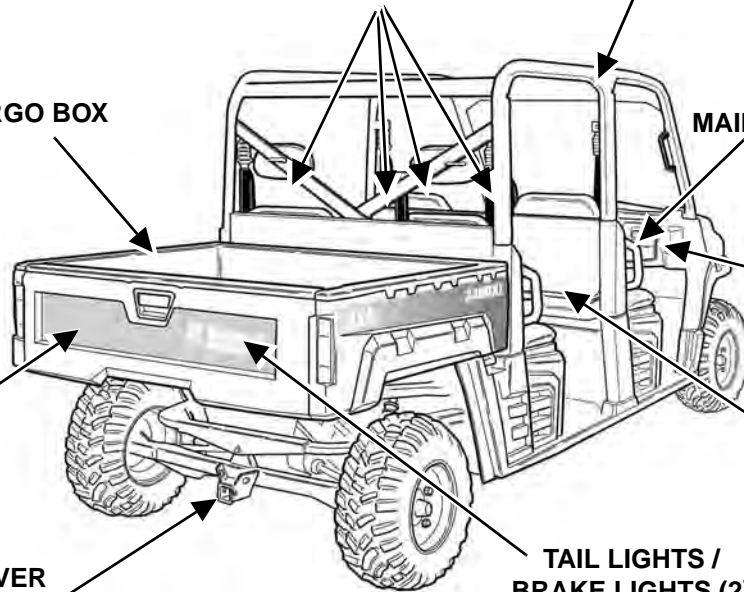

STORAGE  
COMPARTMENT

GRAB HANDLE

TAILGATE

RECEIVER  
HITCH

TAIL LIGHTS /  
BRAKE LIGHTS (2)

NA9393

NA9394

[1] ROPS - Roll-Over Protective Structure, per OSHA 1928.53: 2006.  
OPS - Occupant Protective Structure per ANSI/OPEI B71.9-2012.

## SAFETY & MAINTENANCE

LIFTING AND BLOCKING THE UTILITY VEHICLE .....	10-10-1
Procedure .....	10-10-1
ROLLOVER PROTECTIVE STRUCTURE (ROPS) .....	10-20-1
Description .....	10-20-1
TRANSPORTING THE UTILITY VEHICLE ON A TRAILER .....	10-30-1
Loading And Unloading .....	10-30-1
Fastening .....	10-30-2
TOWING THE UTILITY VEHICLE .....	10-40-1
Procedure .....	10-40-1
SERVICE SCHEDULE .....	10-50-1
Maintenance Intervals .....	10-50-1
AIR CLEANER SERVICE .....	10-60-1
Pre-Filter Element .....	10-60-1
Replacing Filter Element .....	10-60-2
ENGINE COOLING SYSTEM .....	10-70-1
Checking Level .....	10-70-1
Cleaning .....	10-70-2
Removing And Replacing Coolant .....	10-70-3
FUEL SYSTEM .....	10-80-1
Fuel Specifications .....	10-80-1
Biodiesel Blend Fuel .....	10-80-1
Filling The Fuel Tank .....	10-80-2
Fuel Filter .....	10-80-2
Removing Air From The Fuel System .....	10-80-3
Filling A Portable Fuel Container .....	10-80-3
ENGINE LUBRICATION SYSTEM .....	10-90-1
Checking And Adding Engine Oil .....	10-90-1
Engine Oil Chart .....	10-90-1
Removing And Replacing Oil And Filter .....	10-90-2
CONTINUOUS VARIABLE TRANSMISSION (CVT) .....	10-100-1
CVT Drying .....	10-100-1
CVT Filter .....	10-100-2

GEARCASE .....	10-110-1
Checking Transmission Fluid .....	10-110-1
Transmission Fluid .....	10-110-1
Adding Transmission Fluid .....	10-110-1
Removing And Replacing Transmission Fluid .....	10-110-2
Checking Front Gearcase Fluid .....	10-110-3
Front Gearcase Fluid .....	10-110-3
Adding Front Gearcase Fluid .....	10-110-3
Removing And Replacing Front Gearcase Fluid .....	10-110-4
TIRE MAINTENANCE .....	10-120-1
Tires .....	10-120-1
Tire Tread Depth .....	10-120-1
Axle And Wheel Nut Torque .....	10-120-1
Wheel Removal And Installation .....	10-120-2
Mounting .....	10-120-2
Tire Pressure .....	10-120-2
SPARK ARRESTER MUFFLER .....	10-130-1
Cleaning Procedure .....	10-130-1
UTILITY VEHICLE STORAGE AND RETURN TO SERVICE .....	10-140-1
Storage .....	10-140-1
Return To Service .....	10-140-1
STOPPING THE ENGINE AND LEAVING THE UTILITY VEHICLE .....	10-150-1
Procedure .....	10-150-1
SEAT BELT .....	10-160-1
Inspection And Maintenance .....	10-160-1
LUBRICATING THE UTILITY VEHICLE .....	10-170-1
Lubrication Locations .....	10-170-1

## LIFTING AND BLOCKING THE UTILITY VEHICLE

### Procedure

For service work under the utility vehicle, or to remove the wheels, always support the utility vehicle with jackstands or blocks of adequate capacity for weight of utility vehicle. (See Performance on Page SPEC-10-5.)

Always park the utility vehicle on a flat level surface.

Stop the engine and put the gear selector in PARK.

If removing wheel(s), loosen the wheel nuts slightly before lifting the vehicle.



### AVOID INJURY OR DEATH

Instructions are necessary before operating or servicing machine. Read and understand the Operation & Maintenance Manual, Operator's Handbook and signs (decals) on machine. Follow warnings and instructions in the manuals when making repairs, adjustments or servicing. Check for correct function after adjustments, repairs or service. Untrained operators and failure to follow instructions can cause injury or death.

W-2003-0807

Figure 10-10-1



Place the jackstands (Item 1) [Figure 10-10-1] under the frame at the front of the utility vehicle.

**NOTE: When lifting the utility vehicle, place the jack under front frame [Figure 10-10-1].**

Figure 10-10-2

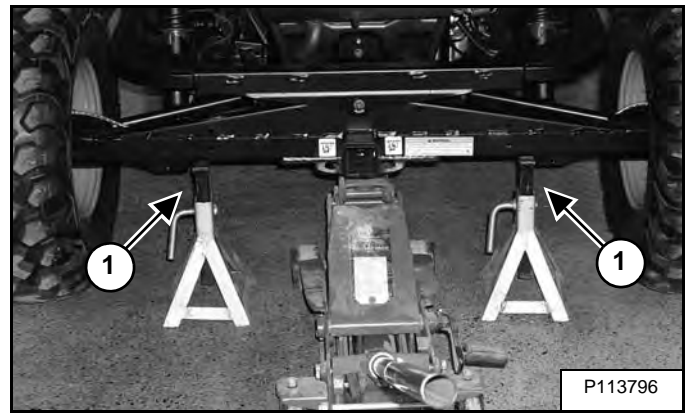

Place the jackstands (Item 1) [Figure 10-10-2] under the rear frame of the utility vehicle.

**NOTE: When lifting the utility vehicle, place the jack under the rear frame [Figure 10-10-2].**

## ROLLOVER PROTECTIVE STRUCTURE (ROPS)

### Description

Figure 10-20-1



The utility vehicle has a Roll-Over Protective Structure (ROPS) / Occupant Protective Structure (OPS) to provide protection from rollover [Figure 10-20-1]. The seat belts must be worn for ROPS / OPS protection.

Check the ROPS / OPS, mounting and hardware for damage. Never modify the ROPS / OPS. Replace the ROPS / OPS and hardware if damaged.

ROPS - Roll-Over Protective Structure per OSHA 1928.53: 2006

OPS - Occupant Protective Structure per ANSI/OPEI B71.9-2012.

## WARNING

### AVOID INJURY OR DEATH

Never modify ROPS by welding, grinding, drilling holes or adding attachments unless instructed to do so by Bobcat Company. Changes to the ROPS can cause loss of operator protection from rollover and result in injury or death.

W-2596-0510

Figure 10-20-2

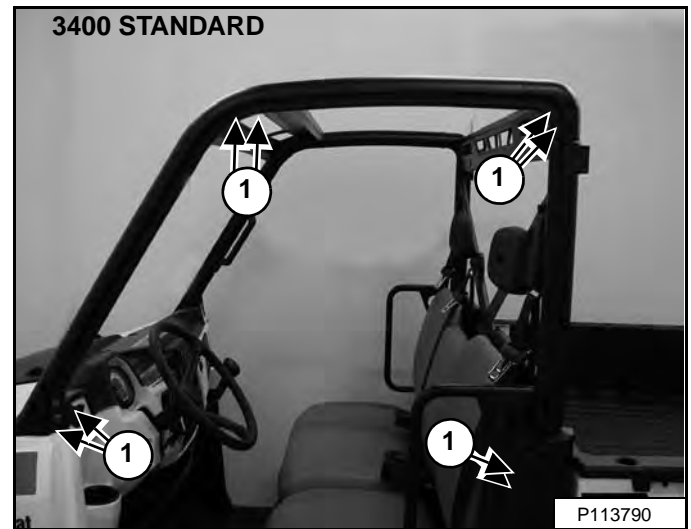
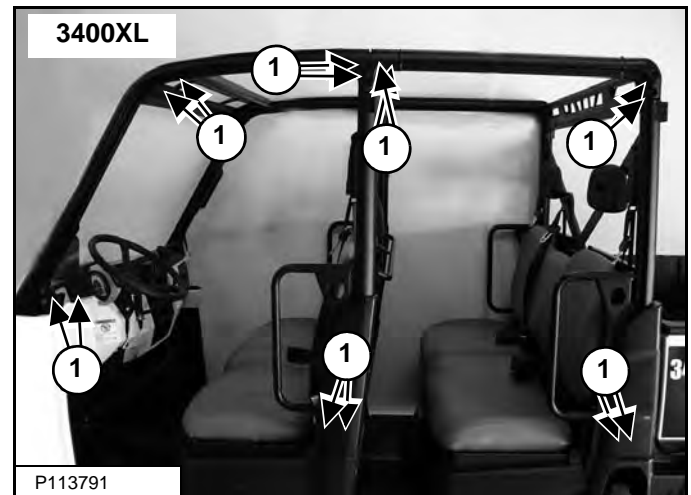

Figure 10-20-3



Make sure all ROPS mounting hardware [Figure 10-20-2], [Figure 10-20-3] is tight (both sides).

**NOTE:** For 3400 Standard machine, there are 8 locations on each side (16 total) to check the torque. For the 3400XL, there are 14 locations on each side (28 total) to check the torque.

The correct torque for ROPS tube to ROPS tube mounting hardware (Item 1) [Figure 10-20-2] and [Figure 10-20-3] is 48 N•m (36 ft-lb).

**NOTE:** The side panels (behind the seat(s)) will need to be removed to access the lower hardware on the ROPS structures.

## TRANSPORTING THE UTILITY VEHICLE ON A TRAILER

### Loading And Unloading

# ! WARNING

### AVOID SERIOUS INJURY OR DEATH

Adequately designed ramps of sufficient strength are needed to support the weight of the machine when loading onto a transport vehicle. Wood ramps can break and cause personal injury.

W-2058-0807

Be sure the transport and towing vehicles are of adequate size and capacity for the weight of utility vehicle. (See Performance on Page SPEC-10-5.)

Figure 10-30-1



The Utility Vehicle can be loaded or unloaded forward or backward [Figure 10-30-1].

The rear of the trailer must be blocked or supported [Figure 10-30-1] when loading or unloading to prevent the front end of the trailer from raising up.

Figure 10-30-2

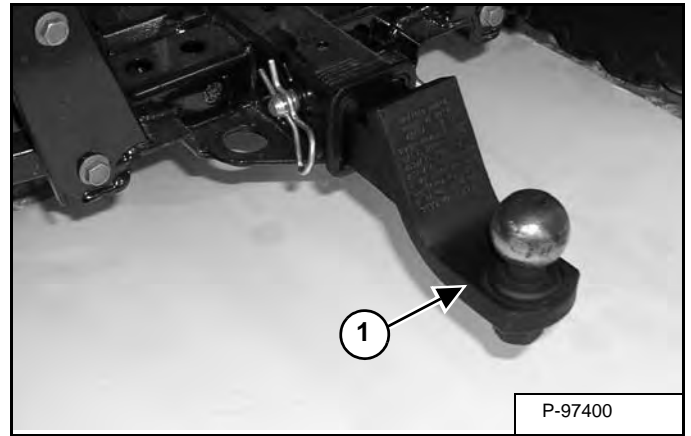

It may be necessary to remove items installed in the receiver hitch (Item 1) [Figure 10-30-2] before loading or unloading to prevent them from hitting the ground.



**Suggest:**

**If the above button click is invalid.**

**Please download this document first, and then click the above link to download the complete manual.**

**Thank you so much for reading**

## TRANSPORTING THE UTILITY VEHICLE ON A TRAILER (CONT'D)

### Fastening

Use the following procedure to fasten the utility vehicle to the transport vehicle to prevent it from moving during turns, sudden stops or when going up and down slopes.

Put the gear selector to PARK, stop the engine and remove the key.

**Figure 10-30-3**

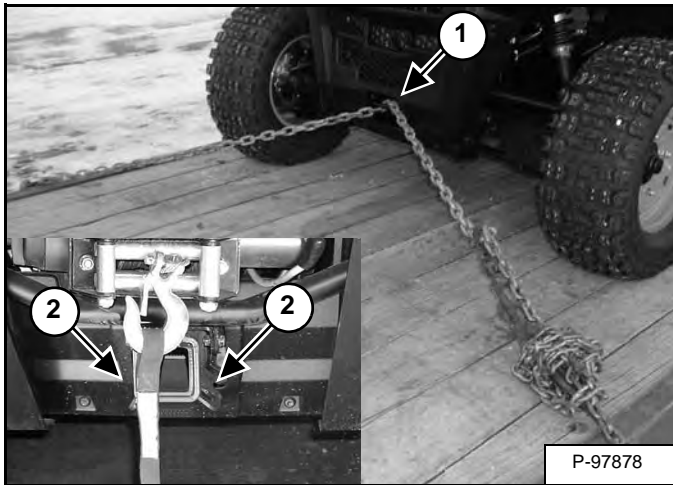

Fasten the front of utility vehicle using the front tie down point (Item 1) [Figure 10-30-3].

If equipped with the front receiver hitch, connect chains to front receiver hitch loops (Item 2) [Figure 10-30-3]

**Figure 10-30-4**

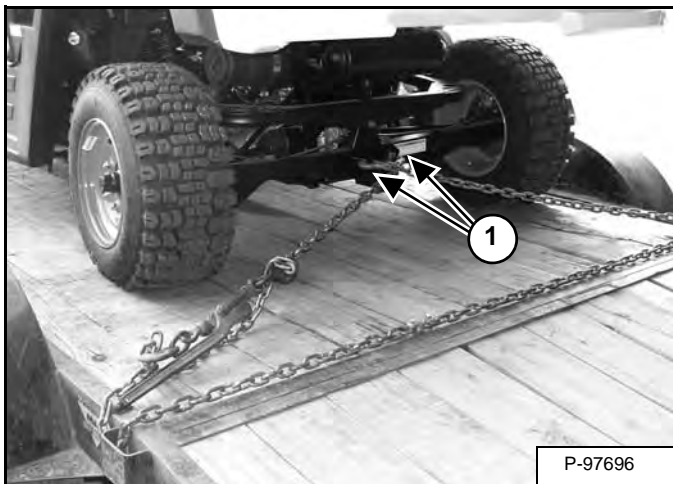

Fasten the rear of utility vehicle using the receiver hitch safety chain loops (Item 1) [Figure 10-30-4] as the tie down point.

Use chain binders to tighten the chains and then safely tie the chain binder levers to prevent loosening.

**<https://www.ebooklibonline.com>**

Hello dear friend!

Thank you very much for reading.

Enter the link into your browser.

The full manual is available for immediate download.

**<https://www.ebooklibonline.com>**