

7

5

3



Service Manual

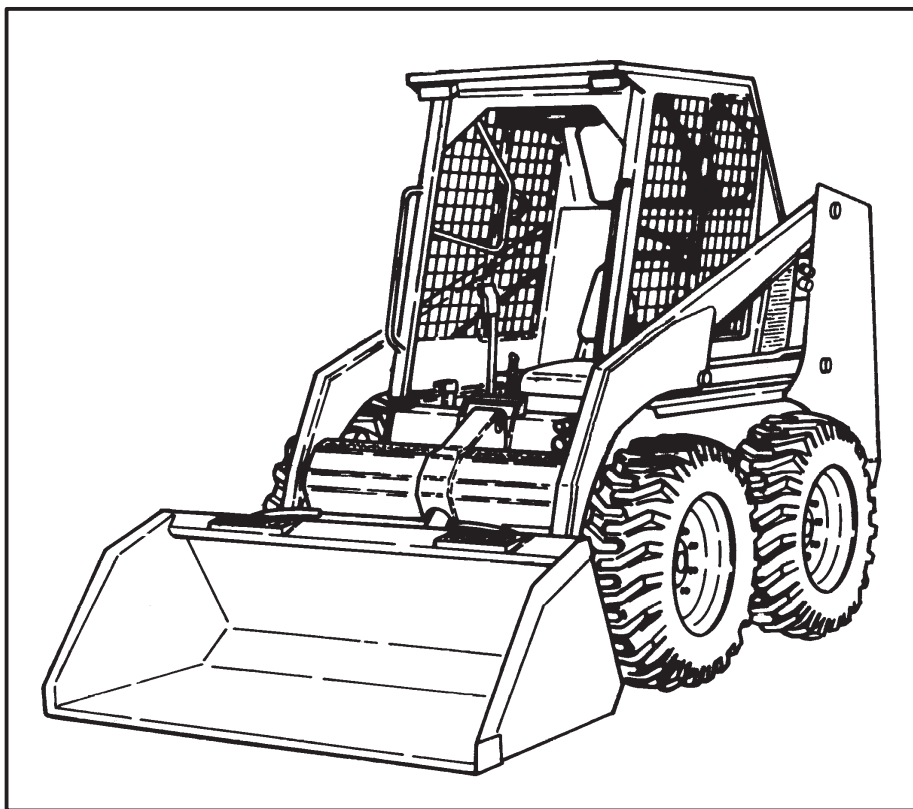

MELROE
INGERSOLL-RAND

6720326(8-90)

Printed in U.S.A.



© Melroe Company 1990

MAINTENANCE SAFETY



WARNING

Instructions are necessary before operating or servicing machine. Read and understand the Operation & Maintenance Manual, Operator's Handbook and signs (decals) on machine. Follow warnings and instructions in the manuals when making repairs, adjustments or servicing. Check for correct function after adjustments, repairs or service. Untrained operators and failure to follow instructions can cause injury or death.

W-2003-0903



Safety Alert Symbol: This symbol with a warning statement, means: "Warning, be alert! Your safety is involved!" Carefully read the message that follows.

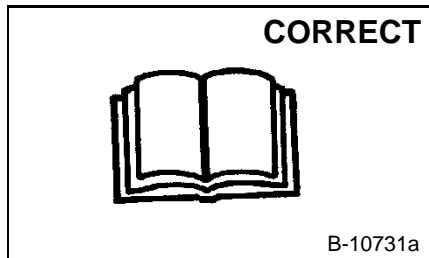

B-10731a

⚠ Never service the Bobcat Skid-Steer Loader without instructions.

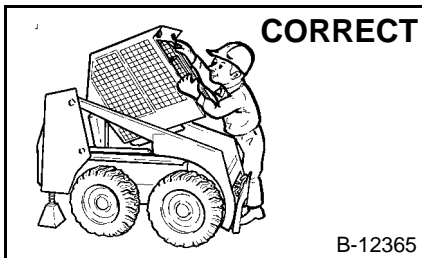

B-12365

⚠ Use the correct procedure to lift or lower operator cab.

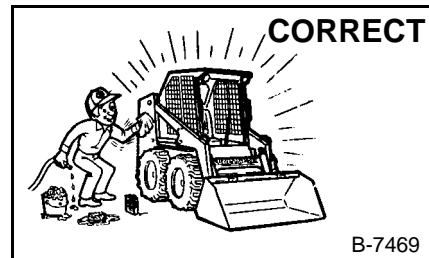

B-7469

⚠ Cleaning and maintenance are required daily.

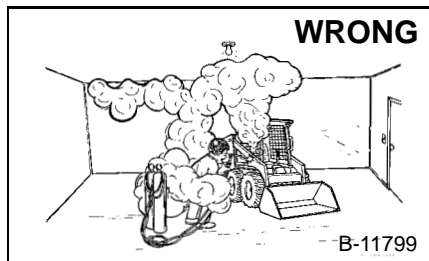

B-11799

- ⚠ Have good ventilation when welding or grinding painted parts.
- ⚠ Wear dust mask when grinding painted parts. Toxic dust and gas can be produced.
- ⚠ Avoid exhaust fume leaks which can kill without warning. Exhaust system must be tightly sealed.

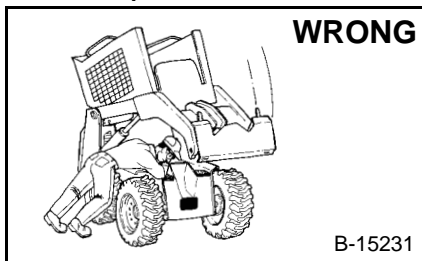

B-15231

⚠ Disconnecting or loosening any hydraulic tubeline, hose, fitting, component or a part failure can cause lift arms to drop. Do not go under lift arms when raised unless supported by an approved lift arm support device. Replace it if damaged.

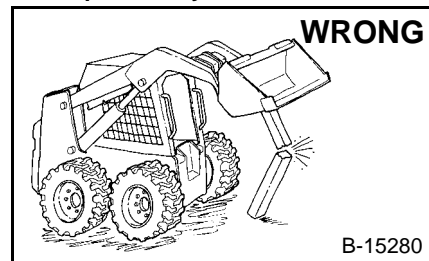

B-15280

- ⚠ Never work on loader with lift arms up unless lift arms are held by an approved lift arm support device. Replace if damaged.
- ⚠ Never modify equipment or add attachments not approved by Bobcat Company.

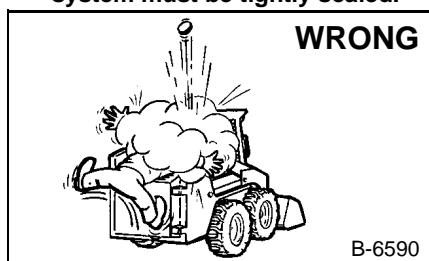

B-6590

- ⚠ Stop, cool and clean engine of flammable materials before checking fluids.
- ⚠ Never service or adjust loader with the engine running unless instructed to do so in the manual.
- ⚠ Avoid contact with leaking hydraulic fluid or diesel fuel under pressure. It can penetrate the skin or eyes.
- ⚠ Never fill fuel tank with engine running, while smoking or when near open flame.

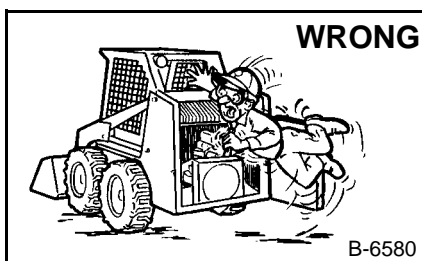

B-6580

- ⚠ Keep body, jewelry and clothing away from moving parts, electrical contact, hot parts and exhaust.
- ⚠ Wear eye protection to guard from battery acid, compressed springs, fluids under pressure and flying debris when engines are running or tools are used. Use eye protection approved for type of welding.
- ⚠ Keep rear door closed except for service. Close and latch door before operating the loader.

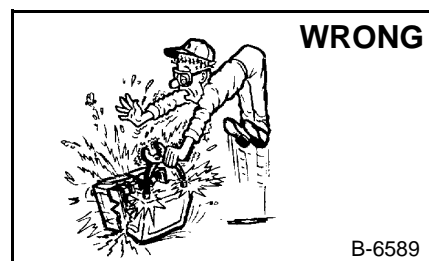

B-6589

- ⚠ Lead-acid batteries produce flammable and explosive gases.
- ⚠ Keep arcs, sparks, flames and lighted tobacco away from batteries.
- ⚠ Batteries contain acid which burns eyes or skin on contact. Wear protective clothing. If acid contacts body, flush well with water. For eye contact flush well and get immediate medical attention.

Maintenance procedures which are given in the Operation & Maintenance Manual can be performed by the owner/operator without any specific technical training. Maintenance procedures which are **not** in the Operation & Maintenance Manual must be performed **ONLY BY QUALIFIED BOBCAT SERVICE PERSONNEL**. Always use genuine Bobcat replacement parts. The Service Safety Training Course is available from your Bobcat dealer.

MSW01-0805

FOREWORD

This manual is for the Bobcat loader mechanic. It provides necessary servicing and adjustment procedures for the Bobcat loader and its component parts and systems. Refer to the Operation & Maintenance Manual for operating instructions, starting procedure, daily checks, etc.

A general inspection of the following items must be made after the loader has had service or repair:

1. Check that the ROPS/FOPS (Including sidescreens) is in good condition and is not modified.

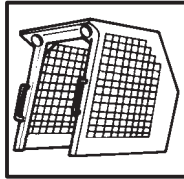

2. Check that ROPS mounting hardware is tightened and is Melroe approved.

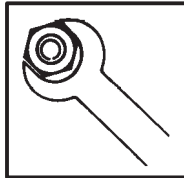

3. The seat belt must be correctly installed, functional and in good condition.

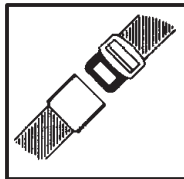

4. The seat bar and pedal interlocks must be correctly adjusted, clean and lubricated.

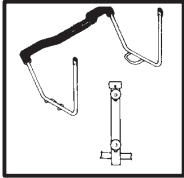

5. Machine signs must be legible and in the correct location.

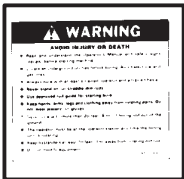

6. Steering levers and foot pedals must return to neutral.

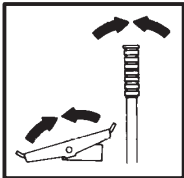

7. Check for correct function of the work lights and travel lights.



8. The parking brake must function correctly.



9. Enclosure door latches must open and close freely.



10. Bob-Tach wedges and linkages must function correctly and be in good condition.

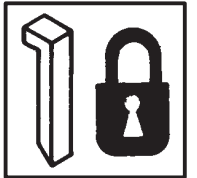

11. Safety treads must in good condition.

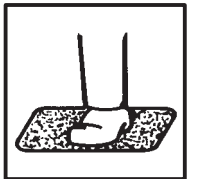

12. Check for correct function of indicator lamps (Optional on some models).

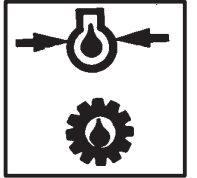

13. Check hydraulic fluid level, engine oil level and fuel supply.

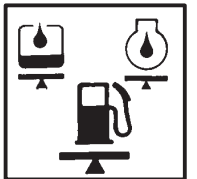

14. Inspect for fuel, oil or hydraulic fluid leaks.

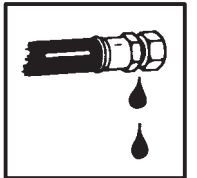

15. Lubricate the loader.



16. Check the condition of the battery and cables.

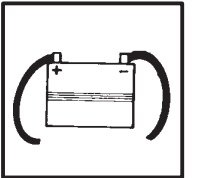

17. Inspect the air cleaner for damage or leaks. Check the condition of the element.

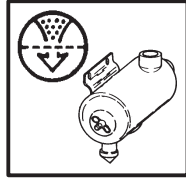

18. Check the electrical charging system.

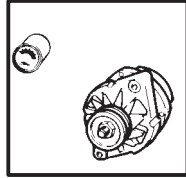

19. Check tires for wear and pressure.

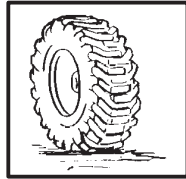

20. Inspect for loose or broken parts or connections.

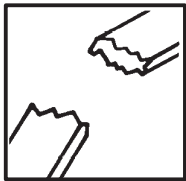

21. Operate the loader and check all functions.

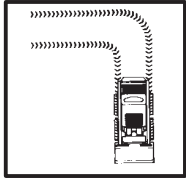

22. Check for any field modification not completed.



Recommend to the owner that all necessary corrections be made before the machine is returned to service.



<https://www.ebooklibonline.com>

Hello dear friend!

Thank you very much for reading.

Enter the link into your browser.

The full manual is available for immediate download.

<https://www.ebooklibonline.com>

CONTENTS

SAFETY INSTRUCTIONS	i
SERIAL NUMBER LOCATIONS	ii
DELIVERY REPORT	iii
BOBCAT LOADER IDENTIFICATION	iii
PREVENTIVE MAINTENANCE	1-1
HYDRAULIC SYSTEM	2-1
HYDROSTATIC SYSTEM	3-1
DRIVE SYSTEM	4-1
MAIN FRAME	5-1
ELECTRICAL SYSTEM	6-1
ENGINE SERVICE	7-1
SPECIFICATIONS	8-1

**PREVENTIVE
MAINTENANCE**

**HYDRAULIC
SYSTEM**

**HYDROSTATIC
SYSTEM**

**DRIVE
SYSTEM**

**MAIN
FRAME**

**ELECTRICAL
SYSTEM**

**ENGINE
SERVICE**

SPECIFICATIONS

**Both new and rebuilt starters
are available from Melroe.**

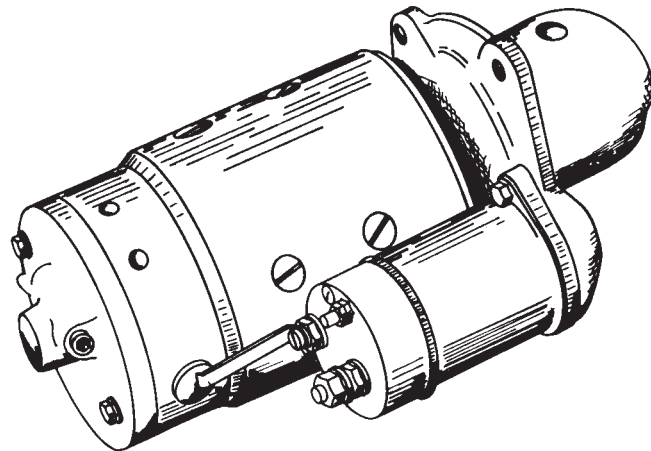

Available at your local Bobcat Dealer.

SAFETY INSTRUCTIONS

WARNING

Instructions are necessary before operating or servicing machine. Read and understand the Operation & Maintenance Manual, Handbook and signs (decals) on machine. Follow warnings and instructions in the manuals when making repairs, adjustments or servicing. Check for correct function after adjustments, repairs or service. Untrained operators and failure to follow instructions can cause injury or death.

W-2003-0299

The following publications provide information on the safe use and maintenance of the loader and attachments:

1. The Delivery Report is used to assure that complete instructions have been given to the new owner and that the machine is in safe operating condition.
2. The Operation & Maintenance Manual delivered with the loader gives operating information as well as routine maintenance and service procedures. It is a part of the loader and must stay with the machine when it is sold.
3. The loader has machine signs (decals) which instruct on the safe care and operation. The signs and their locations are shown in the Operation & Maintenance Manual. Replacement signs are available from your Bobcat loader dealers.
4. The FIEI Manual delivered with the loader gives general safety information.
5. The Service Manual and Parts Manual are available from Bobcat loader dealers for use by mechanics to do shop type service and repair work.

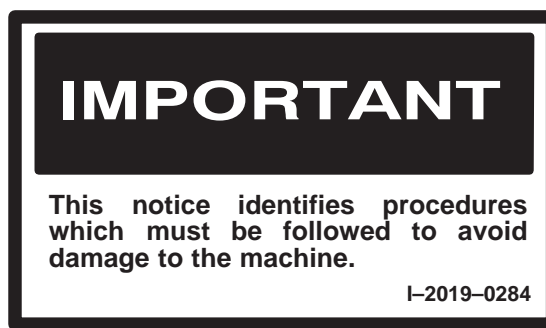

Safety Alert Symbol: This Safety Symbol is used for important safety messages. When you see this symbol follow the safety message to avoid personal injury.

- Wear tight fitting clothing and any other required safety apparel when operating or servicing the loader.
- Wear safety glasses when maintaining or servicing the loader.
- Exhaust gases can kill, vent engine exhaust outdoors.
- Know where fire extinguishers and first aid kits are located and how to use them.
- Do not run the Bobcat loader where exhaust, arcs, sparks or hot components can contact flammable material, explosive dust or gases.
- Check fuel and hydraulic tubes, hoses and fittings for damage and leakage. Never use open flame or bare skin to check for leaks. Tighten or replace any parts that show leakage. Always clean fluid spills. DO NOT use gasoline or diesel fuel for cleaning parts. Use commercial nonflammable solvents.
- Clean the loader before doing any welding. Cover rubber hoses, battery and all other flammable parts. Keep a fire extinguisher near the loader when welding.
- Have good ventilation when welding or grinding painted parts. Wear a dust mask when grinding painted parts. Toxic dust or gas can be produced.
- Stop the engine and let it cool before adding fuel. No smoking!
- Use the procedure in this manual for connecting battery.
- Use the procedure in this manual for cleaning the spark arrestor muffler after each 100 hours of operation.

SERIAL NUMBER LOCATIONS

Always use the serial number of the loader when requesting service information or when ordering parts. Early or later models (identification made by serial number) may use different parts, or it may be necessary to use a different procedure in doing a specific service operation.

LOADER SERIAL NUMBER

The loader serial number plate is located on the inside of the left upright, above the grill [A].

Explanation of loader Serial Number:

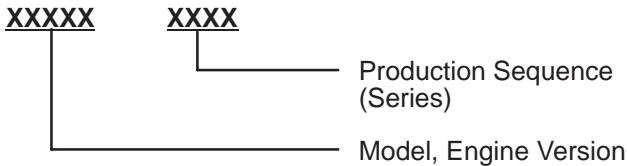

ENGINE SERIAL NUMBER LOCATION

The serial number is near the fuel injection pump on the engine block [B].

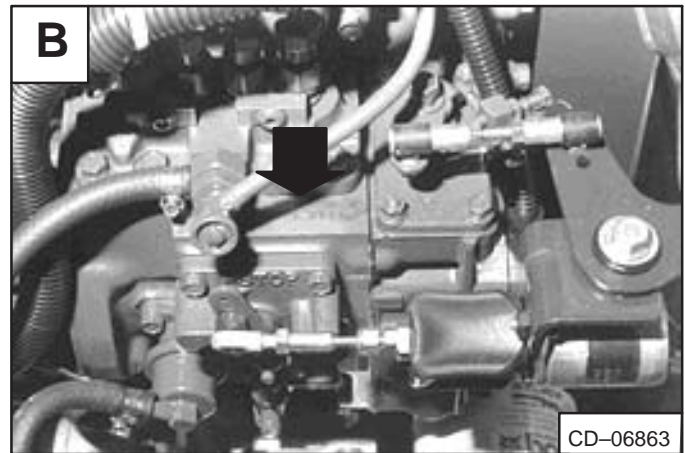
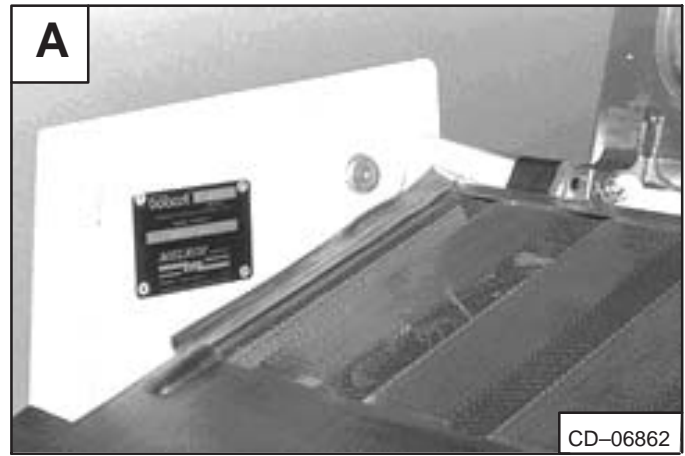

DELIVERY REPORT

The Delivery Report must be filled out by the dealer and signed by the owner or operator when the Bobcat loader is delivered. An explanation of the form must be given to the owner. Make sure it is filled out completely [C].

C

WARNING

Loader must be used only as recommended by manufacturer and used under proper conditions. Operator must read and understand the Operator's Manual, Safety Manual, and any other attachments. Failure to do so may result in injury or death.

The following items are to be checked to stay and explained in detail to the Owner/Operator by the Dealer at time of delivery:

1. Explain delivery jacket (Operator's Manual, Safety Manual and Warranty Brochure) when given to Owner/Operator.
2. Advise owner that dealer is the source for operator training by providing demonstrations, publications and review of job requirements and recommended loader attachment usage.
3. Explain capabilities and restrictions of loader and attachments for job usage, as specified by Owner/Operator.
4. Review machine Safety Signs (Stickers), Operator's Manual and Safety Manual operations.
5. Explain plastic Operator Handbook attached with a label on the operator's cab, on Models A400 through 800 Series, 1080-B, 1600 & 2000.
6. Show how to enter and exit loader safely, with lift arms down.
7. Demonstrate use of seat belt and seat L or R bar as provided for this model. Seat bars are available for all Models A400 through 800 Series, 1600 and 2000.
8. Demonstrate how to start, stop, turn and park the loader. Also show how to lift, carry and dump the bucket or use other attachments.
9. Explain use of operator cab which is a Fall-Over and Falling Object Protection Structure. Cuts are available for all loaders and lift trucks. DO NOT modify or remove operator cab.
10. Explain Enclosures and Spacing Application Kit available to keep operator from entering cab openings.
11. Explain the use of the rear window opening of the cab door handle in an emergency exit. DO NOT modify this opening or spacing enclosure which blocks this exit.
12. Explain rated operating capacity for safety and stability of the loader and attachments.
13. Explain about rated & availability of bucket types and sizes for use with different materials.
14. Explain recommended hoisting and lubricating procedures.
15. Advise owner to use the loader in an environment with explosive dusts or gases or with flammable materials near machine. Explain availability of loader with DE rating for use indoors.
16. Advise Owner/Operator of all available attachments and accessories, such as: Lift Arm Stops, Single Point Lift Warning Alarm and Lights and others.
17. Review maintenance procedure with Operator under maintenance plan as found in Operator's Manual.
18. Explain "Warranty Policy" and limitations to Owner/Operator. Copy of Warranty Statement found in Operator's Manual and Warranty Brochure included in delivery package.

The above delivery information has been explained to me. I understand the operation and maintenance of the machine. I also acknowledge the warranty conditions and limitations as outlined in my copy of the warranty statement.

Owner/Operator Signature _____ Date _____

Dealer Representative Signature _____ Date _____

1400 1st Street, Bristol, Vermont 05435 • 800-445-9633 • 802-548-2100 • Fax 802-548-2101 • www.bobcat.com • Printed in U.S.A.

V. BOBCAT LOADER IDENTIFICATION

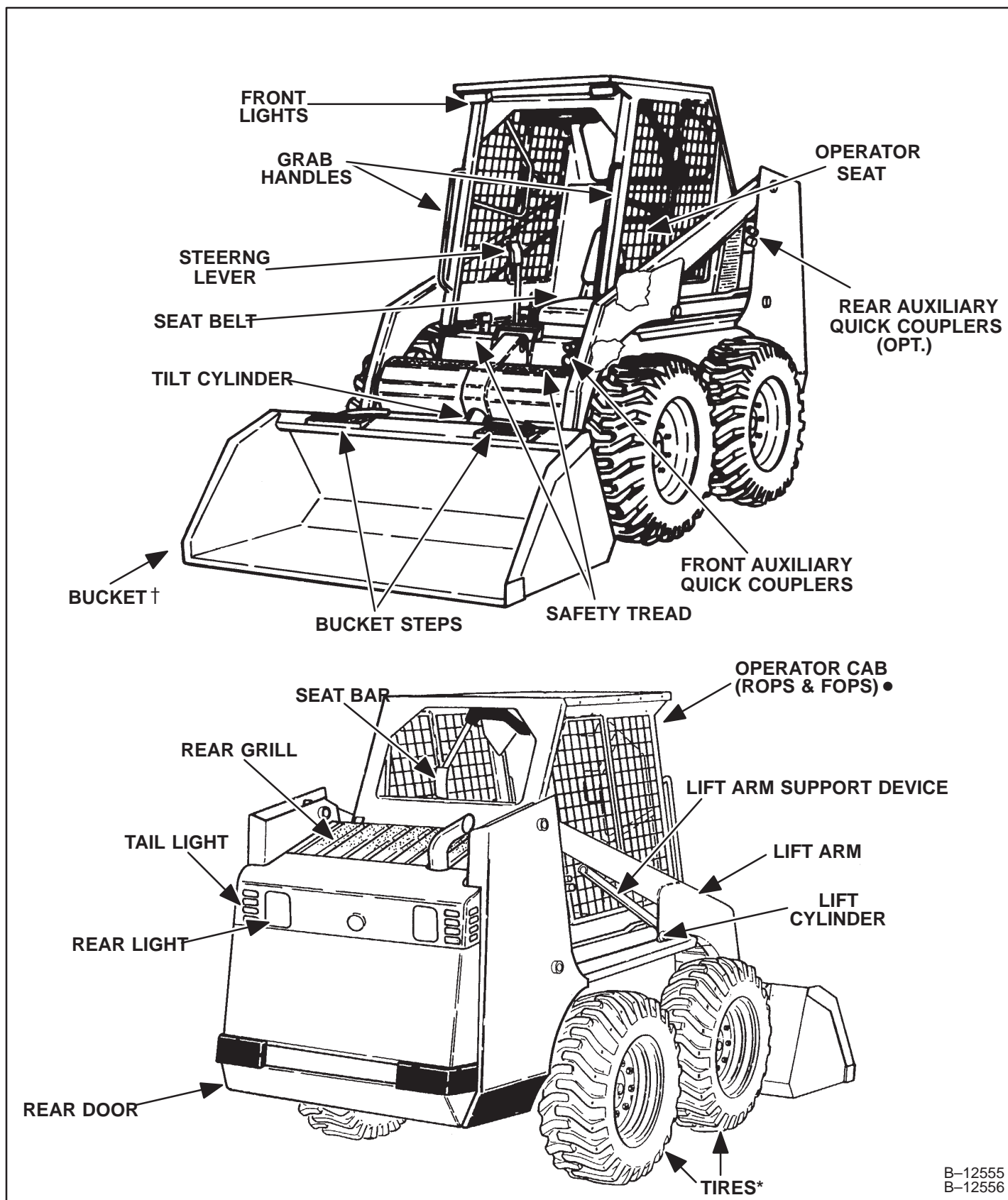

B-12555
B-12556

- * TIRES – Flotation tires are shown. The Bobcat loader is base-equipped with standard tires.
- † BUCKET – Several different buckets and other attachments are available for the Bobcat loader.
- ROPS, FOPS – Roll-Over Protective Structure, Falling Object Protective Structure, per SAE J1040 and SAE J1043. The Bobcat loader is base-equipped with standard operator cab as shown.

**Melroe has engine oil
blended to our specifications
which meet or exceed the highest
demands of your engine.**

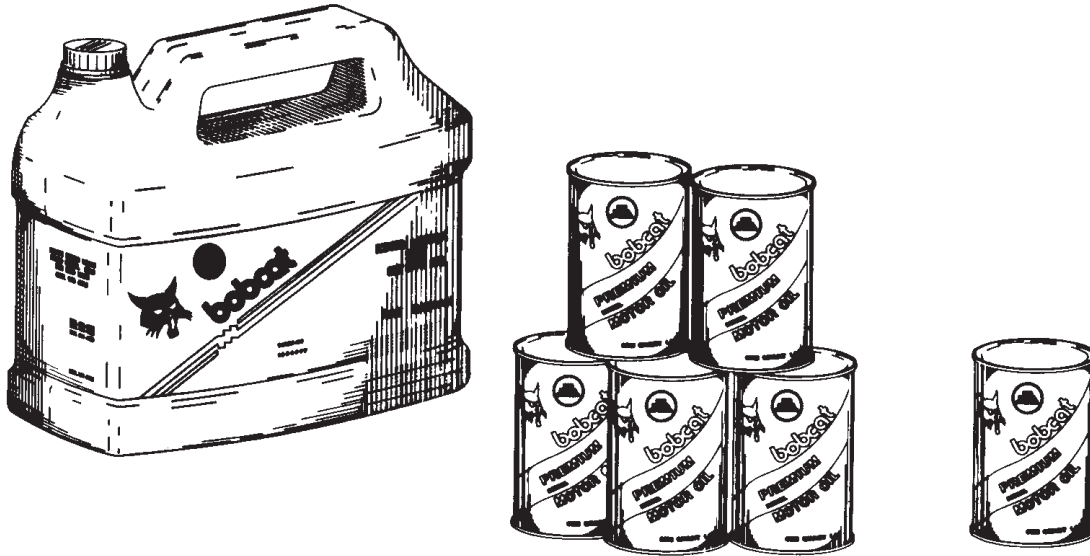

Available at your local Bobcat Dealer.

PREVENTIVE MAINTENANCE

PREVENTIVE MAINTENANCE

	Page Number
AIR CLEANER	
Replacement of the Filter Element	1-7
ALTERNATOR BELT	
Adjusting the Alternator Belt	1-15
DIAGNOSTIC TOOL	
Procedure	1-26
DRIVE BELT	
Adjustment	1-21
Drive Belt Replacement	1-22
ENGINE COOLING SYSTEM	
Cleaning the Cooling System	1-13
Coolant Level	1-13
Removing Coolant from the Cooling System	1-14
ENGINE LUBRICATION SYSTEM	
Checking Engine Oil	1-11
Replacement of Oil and Filter	1-11
FAN GEARBOX	
Checking Grease Level	1-20
FINAL DRIVE TRANSMISSION (CHAINCASE)	
Checking and Adding Oil	1-20
FUEL SYSTEM	
Filling the Fuel Tank	1-9
Fuel Filter	1-9
Fuel Specifications	1-9
Removing Air from the Fuel System	1-10
HYDRAULIC/HYDROSTATIC SYSTEM	
Checking and Adding Fluid	1-17
Hydraulic/Hydrostatic Filter Replacement	1-17
Hydraulic Reservoir Breather Cap	1-17
LIFT ARM SUPPORT DEVICE	
To Disengage Lift Arm Support Device	1-4
To Engage Lift Arm Support Device	1-4
LIFTING AND BLOCKING THE LOADER	
Procedure	1-2
LIFTING THE LOADER	
Procedure	1-3
LUBRICATION OF THE LOADER	
Procedure	1-23
MONITOR SERVICE CODES	
Chart	1-27
OPERATOR CAB	
Description	1-5
Lowering the Operator Cab	1-5
Raising the Operator Cab	1-5
Lowering the Operator Cab (W/Hand Controls)	1-5b
Raising the Operator Cab (W/Hand Controls)	1-5a

PREVENTIVE MAINTENANCE (Cont'd)

	Page Number
REMOTE START SWITCH	
Procedure	1-25
SEAT BAR SYSTEM	
Description	1-6
Seat Bar Inspection	1-6
Seat Bar Maintenance	1-6
SENDER AND SENSORS	
Service Checks	1-26
SERVICE CODES	
Chart	1-28
SERVICE SCHEDULE	
Chart	1-1
SPARK ARRESTOR MUFFLER	
Cleaning Procedure	1-18
TIRE MAINTENANCE	
Tire Inflation	1-19
Tire Rotation	1-19
Wheel Nuts	1-19
TRANSPORTING THE LOADER	
Procedure	1-3
TROUBLESHOOTING THE B.O.S.S. & L.C.D. DISPLAY	
Chart	1-30
USING AN BOOSTER BATTERY (JUMP STARTING)	
Procedure	1-16

SERVICE SCHEDULE

Maintenance work must be done at regular intervals. Failure to do so will result in excessive wear and early failures. The service schedule is a guide for correct maintenance of the Bobcat loader.



Instructions are necessary before operating or servicing machine. Read Operation & Maintenance Manual, Handbook and signs (decals) on machine. Follow warnings and instructions in the manuals when making repairs, adjustments or servicing. Check for correct function after adjustments, repairs or service. Failure to follow instructions can cause injury or death.

W-2003-1289

SERVICE SCHEDULE		HOURS				
ITEM	SERVICE REQUIRED	8-10	50	100	250	1000
Engine Oil	Check the oil level & add oil as needed.					
Air Cleaner	Check display. Service only when required.					
Engine Cooling System	Clean debris from oil cooler, radiator & grill. Check coolant level cold in recovery tank. Add 50/50 ethylene glycol & water as needed.					
Lift Arms, Cyl., Bob-Tach Pivot Pins & Wedges	Lubricate with multi-purpose lithium based grease (20 places).					
Engine Air System	Check for leaks & damaged components.					
Tires	Check for damaged tires & correct air pressure.					
Seat Belt, Seat Bar & Pedal Interlocks	Check the condition of seat belt. Check the seat bar & pedal interlocks correct operation. Clean dirt & debris from moving parts.					
Safety Signs & Safety	Check for damaged signs (decals) & safety tread. Replace any signs or safety treads that are damaged or worn.					
Operator Cab	Check the fastening bolts, washers & nuts. Check the condition of cab.					
Fuel Filter	Remove the trapped water.					
Hyd. Fluid, Hoses & Tubelines	Check fluid level & add as needed. Check for damage & leaks. Repair & replace as needed.					
Final Drive Trans. (Chaincase)	Check oil level.					
Battery	Check cables & electrolyte level.					
Control Pedals & Steering	Check for correct operation. Repair or adjust as needed.					
Wheel Nuts	★ Check for loose wheel nuts & tighten to 105-115 ft.-lbs. (142-156 Nm) torque.					
Parking Brake	Check operation & adjust as needed.					
Alternator Belt	Check tension & adjust as needed.					
Engine Oil & Filter	Replace oil & filter.					
Spark Arrestor Muffler	Clean the spark chamber.					
Engine/Hydro. Drive Belt	* Check for wear or damage. Make adjustment as needed.					
Fuel Filter	Replace filter element.					
Seat Bar	Grease pivots as needed.					
Steering Shaft	Grease two fittings.					
Hyd./Hydro. Filter	● Replace the filter element.					
Hyd. Reservoir Breather Cap	Replace the reservoir breather cap.					
Fan Drive Gearbox	Check gear lube level.					
Final Drive Trans.	Replace the oil in the chaincase.					
Hyd. Reservoir	Replace the fluid.					
Case Drain Filters	Replace the filters.					

★ Check wheel nut torque every 8 hours for the first 24 hours.

● Also replace hydraulic/hydrostatic filter element when the transmission warning light comes "ON".

■ Or Every 12 Months.

* Inspect the new belt after first 50 hours.

1 PREVENTIVE MAINTENANCE

! WARNING

Instructions are necessary before operating or servicing machine. Read Operation & Maintenance Manual, Handbook and signs (decals) on machine. Follow warnings and instructions in the manuals when making repairs, adjustments or servicing. Check for correct function after adjustments, repairs or service. Failure to follow instructions can cause injury or death.

W-2003-0797

LIFTING AND BLOCKING THE LOADER

Procedure

Always park the loader on a level surface.

! WARNING

Put jackstands under the front axles and rear corners of the frame before running the engine for service. Failure to use jackstands can allow the machine to fall or move and cause injury or death.

W-2017-0286

Put floor jack under the rear of the loader [B].

Lift the rear of the loader and install jackstands [B].

Put the floor jack under the front of the loader [C].

Lift the front of the loader and put jackstands under the axle tubes [C].

NOTE: Make sure the jackstands do not touch the tires.

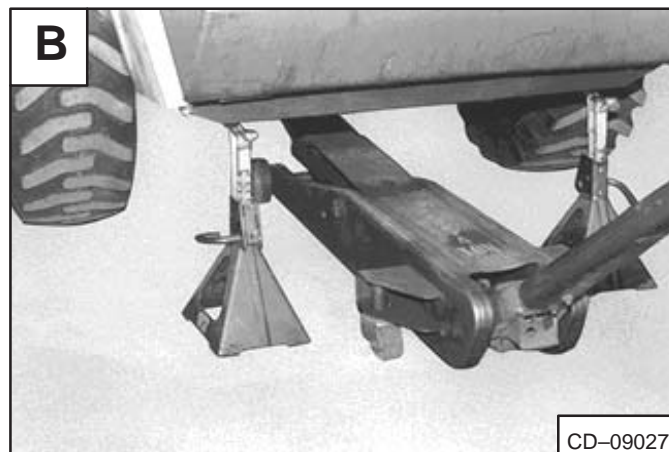
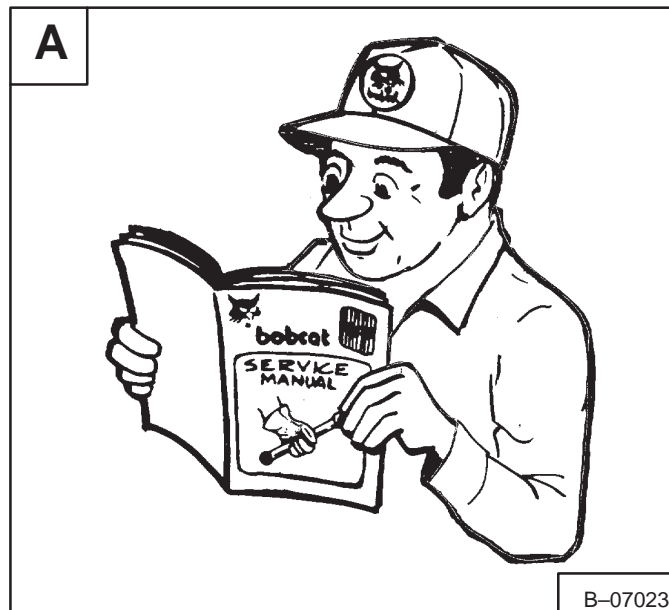

TRANSPORTING THE LOADER

Procedure



WARNING

Adequately designed ramps of sufficient strength are needed to support the weight of the machine when loading onto a transport vehicle. Wood ramps can break and cause personal injury.

W-2058-0494

A loader with an empty bucket or no attachment must be loaded backward onto the transport vehicle [A].

Use the following procedure to fasten the Bobcat loader to the transport vehicle to prevent the loader from moving during sudden stops or when going up or down slopes [B]:

1. Lower the bucket or attachment to the floor. Stop the engine.
2. Engage the parking brake.
3. Install chains at the front and rear of the loader.

LIFTING THE LOADER

Procedure



WARNING

AVOID INJURY OR DEATH

- Before lifting, check fasteners on four point lift.
- Never allow riders in the cab or bystanders within 15 feet (5 meters) while lifting the machine.

W-2160-0694

The loader can be lifted with the four point lift which is available as a kit from your Bobcat loader dealer.

Install the lift eyes in the kit as shown in Fig. [C].

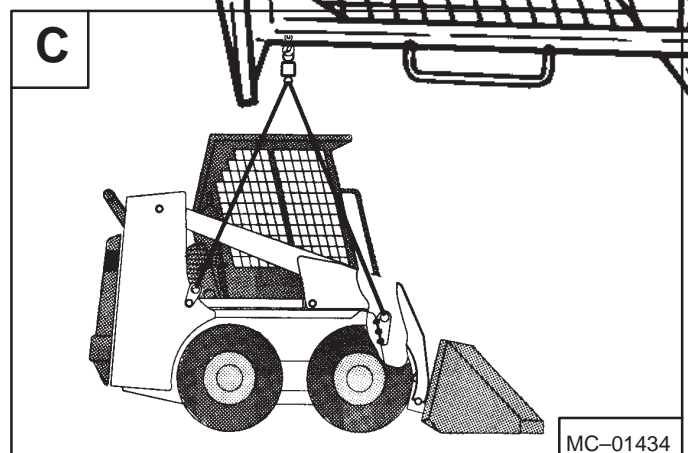
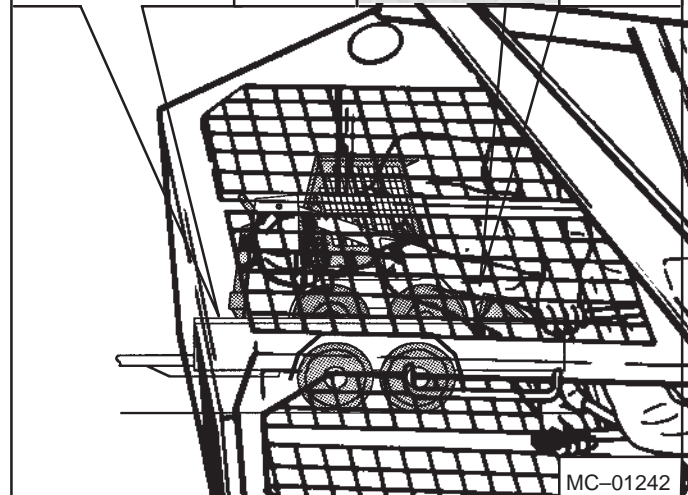
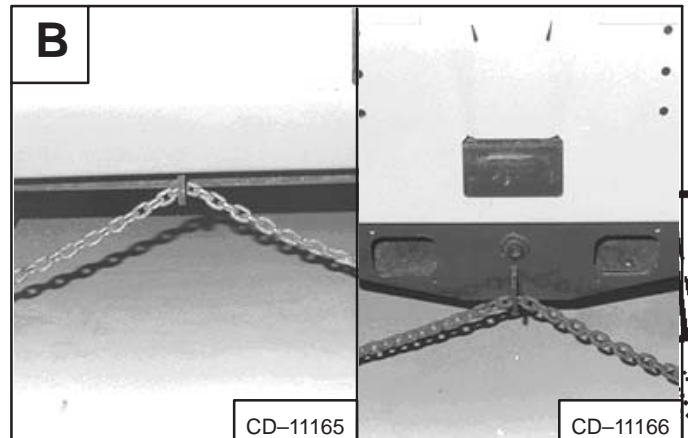
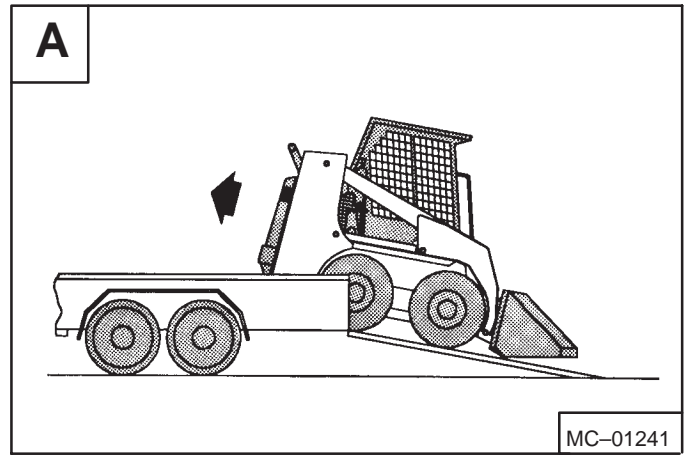

LIFT ARM SUPPORT DEVICE

To Engage Lift Arm Support Device



WARNING

Never work on a machine with the lift arms up unless the lift arms are secured by an approved lift arm support device. Failure to use an approved lift arm support device can allow the lift arms or attachment to fall and cause injury or death.

W-2059-0598

Maintenance and service work can be done with the lift arms lowered. If the lift arms are raised, use the following procedure:

Put jackstands under the rear corners of the loader.

Disconnect the spring from the lift arm support device retaining pin, hold onto the support device and remove the retaining pin **[A]**.

Lower the lift arm support device on top of the lift cylinder. Hook the free end of the spring to the lift arm support device so there will be no interference with the support device installation. With the operator in the seat, seat belt fastened and seat bar lowered, start the engine.

Raise the lift arms, until the lift arm support device drops onto the lift cylinder rod **[B]**.

Lower the lift arms slowly until the support device is held between the lift arm and the lift cylinder. Stop the engine. Raise the seat bar and unfasten the seat belt.

Install pin into the rear of the lift arm support device below the cylinder rod.

To Disengage Lift Arm Support Device

Remove the pin from the lift arm support device.

Connect the spring from the lift arm support device to the retainer plate on the lift arms **[C]**.

With the operator in the seat, seat belt fastened and seat bar lowered, start the engine. Raise the lift arms a small amount and the spring will lift the support device off the lift cylinder rod. Lower the lift arms. Stop the engine.

Lift the support device into the storage position and install the retaining pin and connect the spring **[A]**.



OPERATOR CAB

Description

The Bobcat loader has an operator cab (ROPS and FOPS) as standard equipment to protect the operator from rollover and falling objects. Replace the operator cab if it has been damaged.

WARNING

Never modify operator cab by welding, grinding, drilling holes or adding attachments unless instructed to do so by Melroe Company. Changes to the cab can cause loss of operator protection from rollover and falling objects, and result in injury or death.

W-2069-1285

Raising the Operator Cab

Stop the loader on a level surface. Lower the lift arms, if the lift arms must be up while raising the operator cab, install the lift arm support device (Page 1-4).

WARNING

Before the cab or the lift arms are raised for service, jackstands must be put under the rear corners of the frame. Failure to use jackstands can allow the machine to tip backward causing injury or death.

W-2014-0895

Loosen the nut (both sides) at the front corner of the operator cab [A].

Remove the nut and plate (both sides) [B].

Lift on the grab handle and bottom of the operator cab slowly until the cab latching mechanism engages and the cab is all the way up [C].

Lowering the Operator Cab

Pull down on the bottom of the operator cab until it is stopped by the latching mechanism. Release the latching mechanism and pull the cab all the way down [D].

Install the nut and plate (both sides) [B].

Tighten the nuts to 40–50 ft.-lbs. (54–68 Nm) torque.

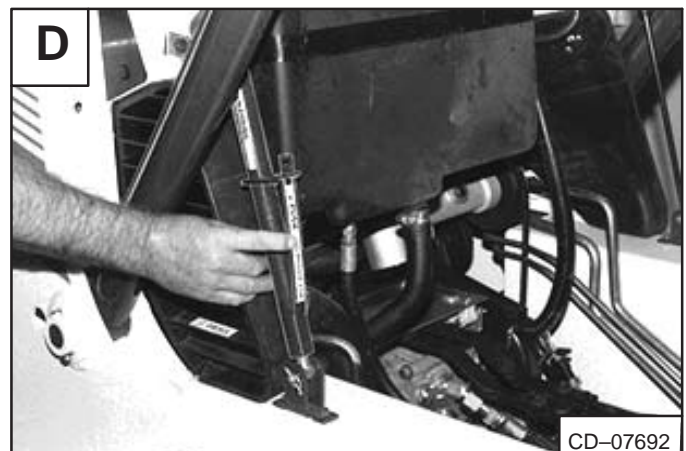
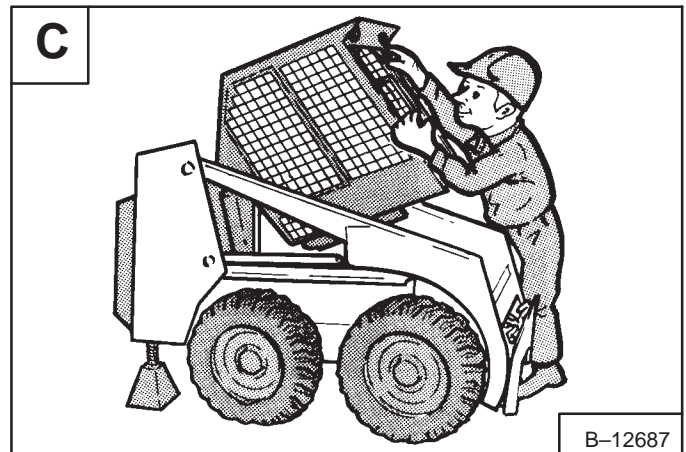
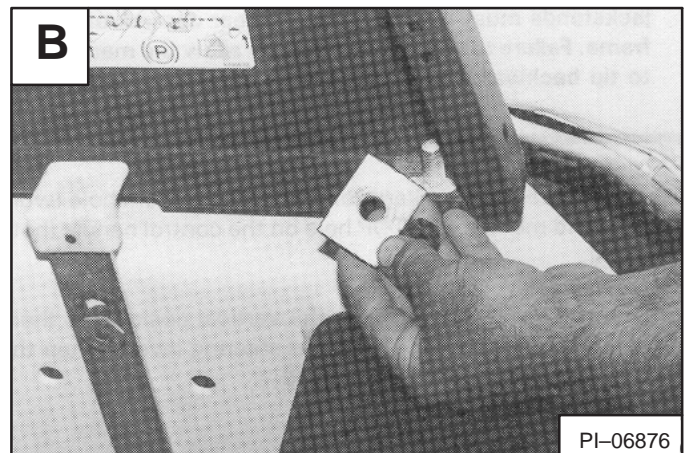
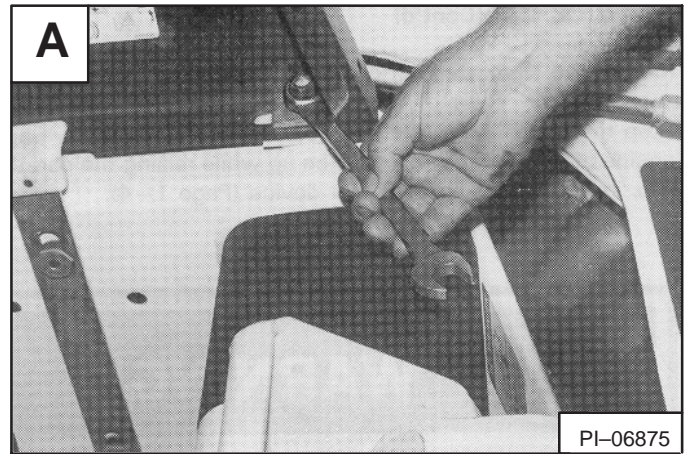

OPERATOR CAB (Cont'd)

Raising the Operator Cab (W/Hand Controls)

Stop the loader on a level surface. Lower the lift arms. Shut engine off. If the lift arms must be up while raising the operator cab, install the lift arm support device (Page 1-4).

WARNING

Before the cab or the lift arms are raised for service, jackstands must be put under the rear corners of the frame. Failure to use jackstands can allow the machine to tip backward causing injury or death.

W-2014-0895

Disconnect the control linkage joint from the bottom hole (work position) and move to the TOP hole on the control handle (both sides) [A].

Both control handles must be in the vertical position so there will be no cab interference with the steering levers when the operator cab is raised or lowered [B].

WARNING

AVOID INJURY OR DEATH

Accidental movement of the loader, the lift arms or the attachment can occur if the lift or tilt control handles are not positioned correctly before lifting or lowering the cab.

Move control linkage to top hole in handles as shown, so cab does not hit handles when being lifted or lowered.

W-2157-0594

Loosen the nut (both sides) at the front corner of the operator cab [C].

Remove the nut and plate (both sides) [D].

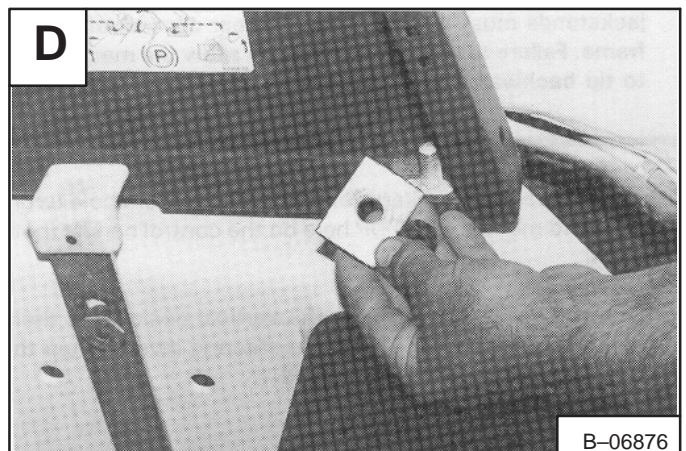
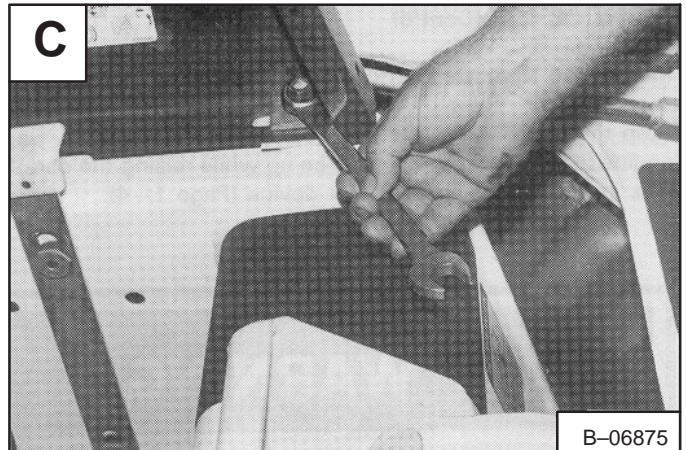
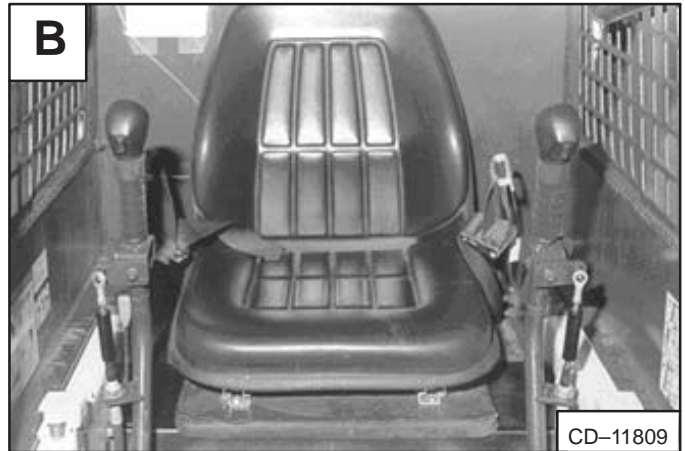
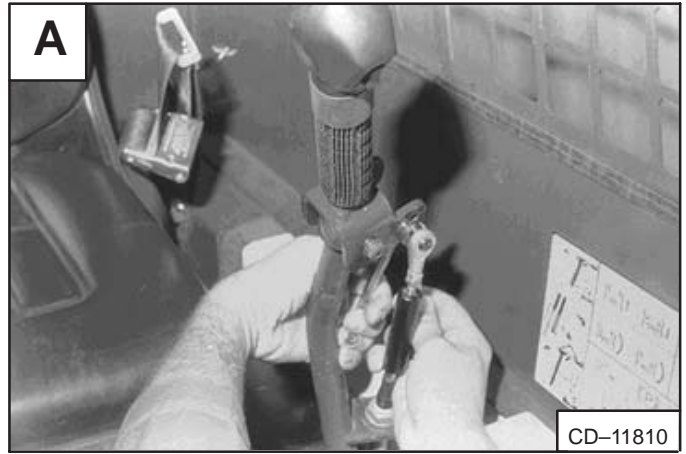

OPERATOR CAB (Cont'd)

Lift on the grab handle and bottom of the loader cab slowly until the cab latching mechanism engages and the cab is all the way up [A].

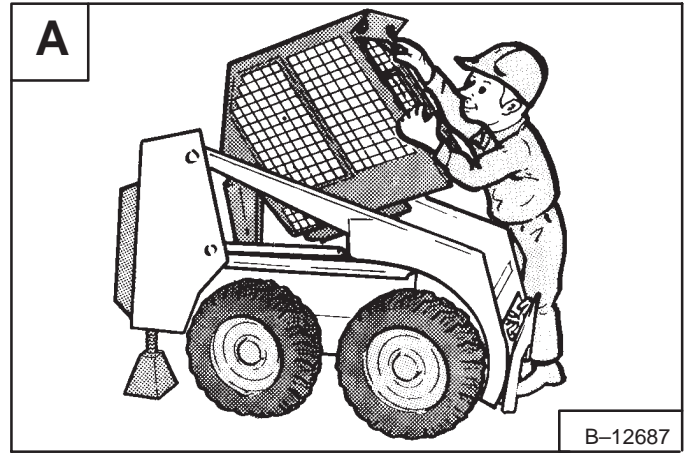

Lowering the Operator Cab (W/Hand Controls)

Pull down on the bottom of the operator cab until it stops at the latching mechanism. Release the latching mechanism and pull the cab all the way down [B].

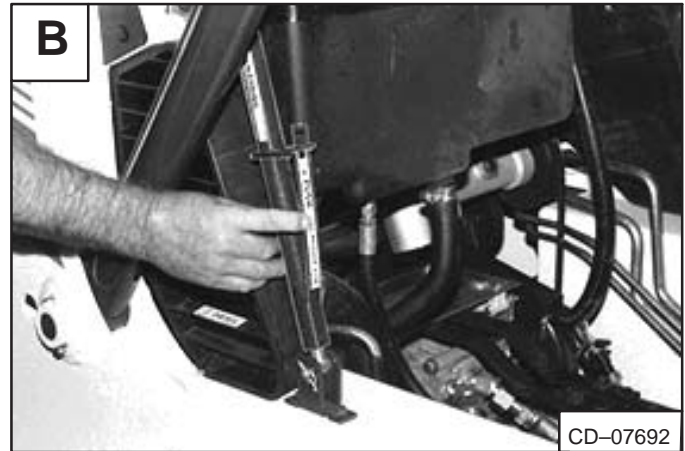

Install the plate and nut (both sides).

Tighten the nuts to 40–50 ft.-lbs. (54–68 Nm) torque [C].

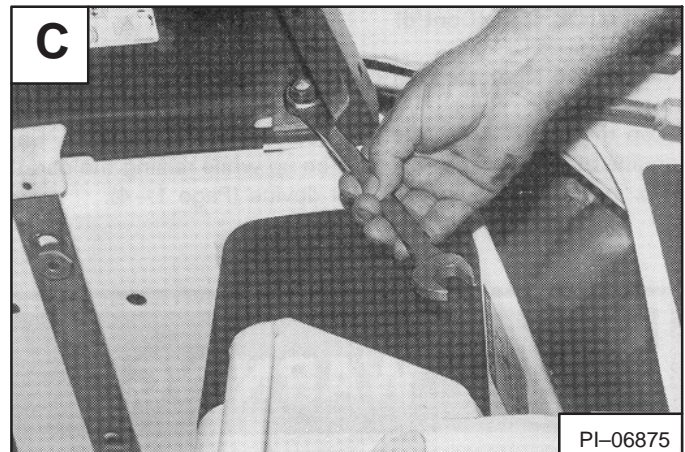

Move the control linkage from the top hole to the BOTTOM hole (work position) on the control handle (both sides) [D].



SEAT BAR SYSTEM

Description

The seat bar system has a pivoting seat bar with arm rests and has spring loaded interlocks for the lift and tilt control pedals. The operator controls the use of the seat bar. The seat bar in the down position helps to keep the operator in the seat, also the interlocks require the operator to lower the seat bar in order to operate the foot pedal controls. When the seat bar is up, the lift and tilt pedals are locked when returned to the neutral position.



Seat Bar Inspection

Sit in the seat and fasten the seat belt. Engage the parking brake. Pull the seat bar all the way down. Start the engine. Operate each foot pedal to check both the lift and tilt functions. Raise the lift arms until the bucket is about 2 feet (600 mm) off the ground.

Raise the seat bar. Try to move each foot pedal. Pedals must be firmly locked in neutral position. There must be no motion of the lift arms or tilt (bucket) when the pedals are pushed.

Pull the seat bar down, lower the lift arms and place the bucket flat on the ground. Stop the engine. Raise the seat bar and operate the foot pedals to be sure that the pedals are firmly locked in the neutral position. Un-buckle the seat belt.

Seat Bar Maintenance

See the Service Schedule (Page 1-1) for the correct service interval.

Clean any debris or dirt from the moving parts **[A]** & **[B]**.

Inspect the linkage bolts and nuts for tightness.

Use a general purpose grease to lubricate the seat bar pivot points on each side of the cab **[A]**.

If the seat bar system does not function correctly, check for free movement of each linkage part. Check for excessive wear. Adjust pedal control linkage. Replace parts that are worn or damaged. Use only genuine Melroe replacement parts.

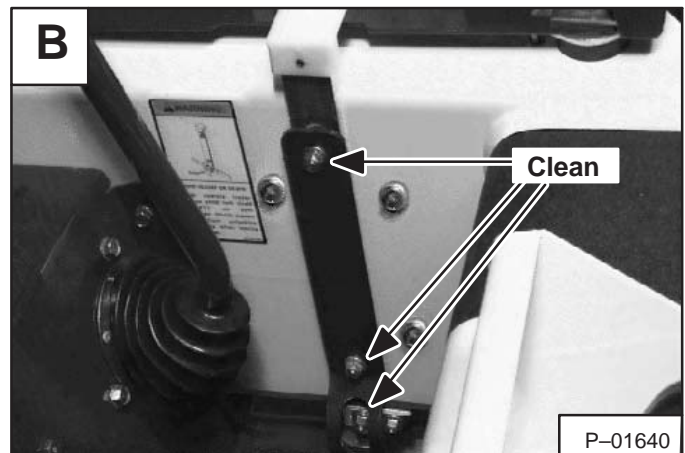
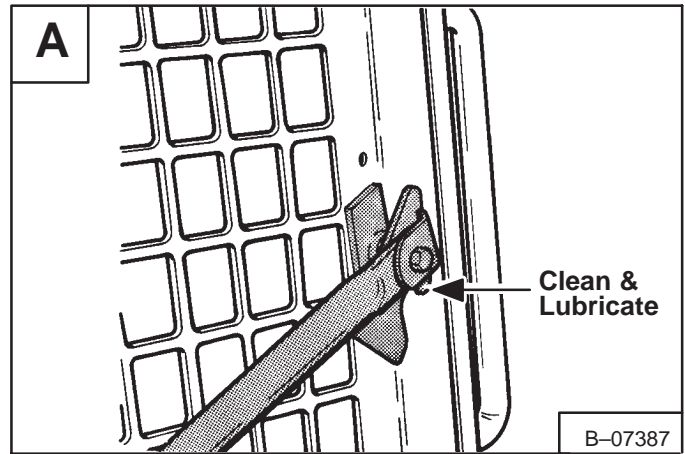

AIR CLEANER

Replacement of the Filter Element

It is important to change the air filter element only when the service code (on the instrument panel) shows the symbol as shown in figure [A].

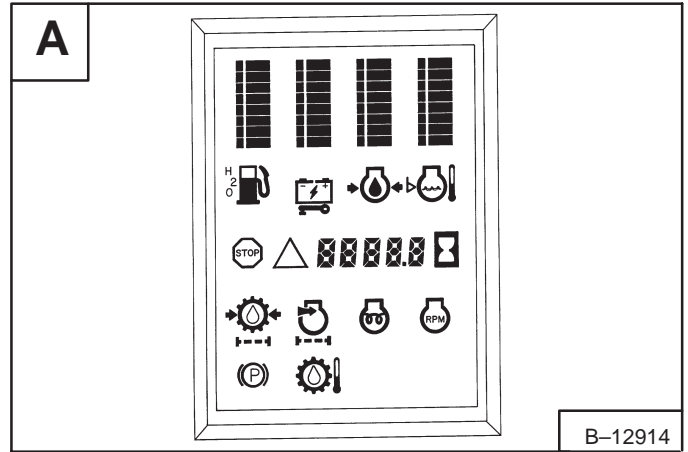

Service the air cleaner as follows:

Remove the dust cover wing nut [B].

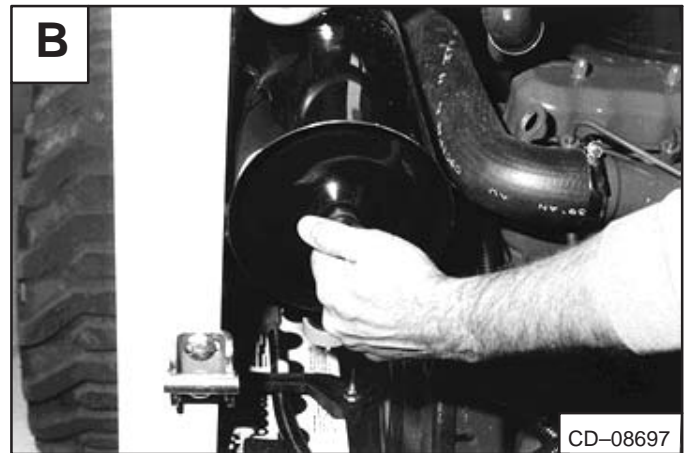

Remove the dust cover [C].

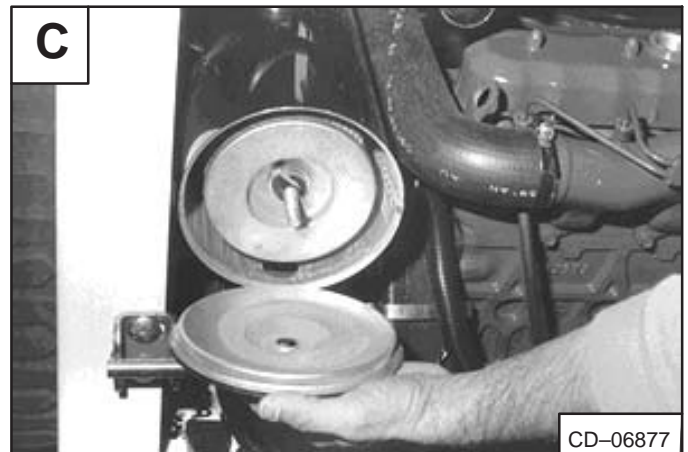

Remove the wing nut holding the large air filter element [D].

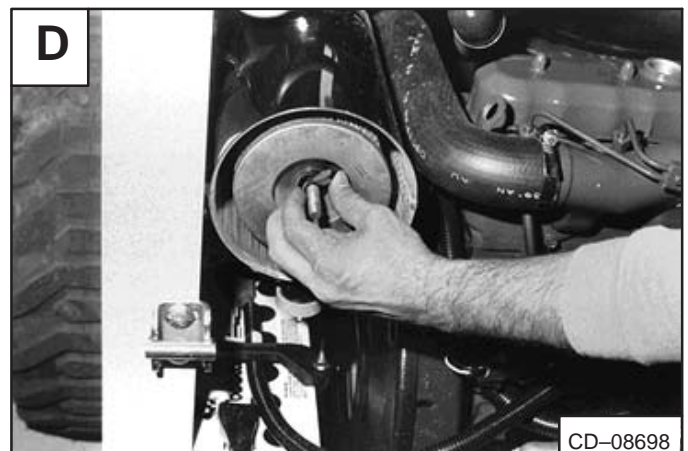

AIR CLEANER (Cont'd)

Remove the large filter element [A].

NOTE: Make sure all sealing surfaces are free of dirt and debris.

Install the new filter element and tighten the wing nut. Install the dust cover and tighten the wing nut.

Check the air intake hose for damage. Check the air cleaner housing for damage. Check to make sure all connections are tight.

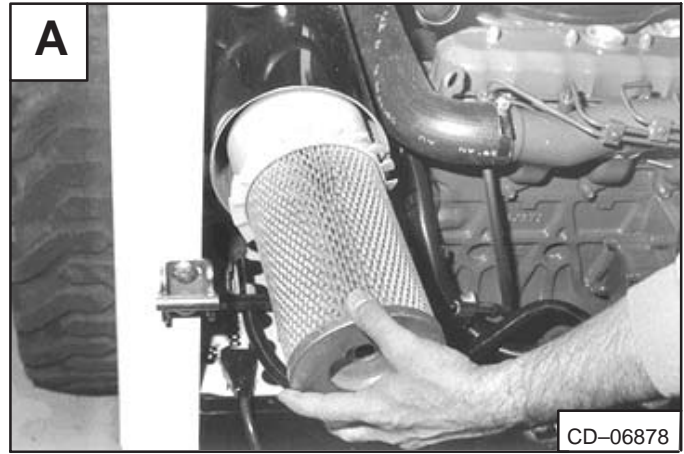

Only replace the inner filter element under the following conditions [B]:

1. Every third time the outer filter is replaced.
2. When the service code shows the symbol (Page 1-7, Figure [A]), only after the outer filter element has been changed and the engine speed is at full RPM.

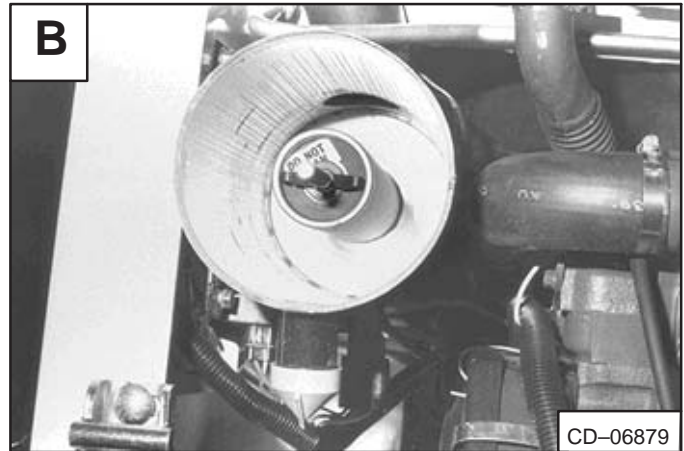

FUEL SYSTEM

Fuel Specifications

Use only clean, high quality fuel. Use Grade No. 2 fuel above 40°F (4°C). Use Grade No. 1 fuel at temperatures below 40°F (4°C).

Filling the Fuel Tank

! WARNING

Stop and cool the engine before adding fuel. **NO SMOKING!** Failure to obey warnings can cause an explosion or fire.

W-2063-0887

Remove the fuel fill cap [A].

Use a clean, approved safety container to add fuel of the correct specifications.

Add fuel only in an area that has free movement of air and no open flames or sparks. **NO SMOKING!** [B].

Install and tighten the fuel fill cap [A].

Fuel Filter

! WARNING

Always clean up spilled fuel or oil. Keep heat, flames, sparks or lighted tobacco away from fuel and oil. Failure to use care around combustibles can cause explosion or fire which can result in injury or death.

W-2103-1285

See the Service Schedule (Page 1-1) for the service interval when to remove the water from the fuel filter.

Loosen the drain at the bottom of the filter element to drain the water from the filter [C].

See the Service Schedule (Page 1-1) for the service interval when to replace the fuel filter.

Use a filter wrench to remove the filter element (Item 1) [D].

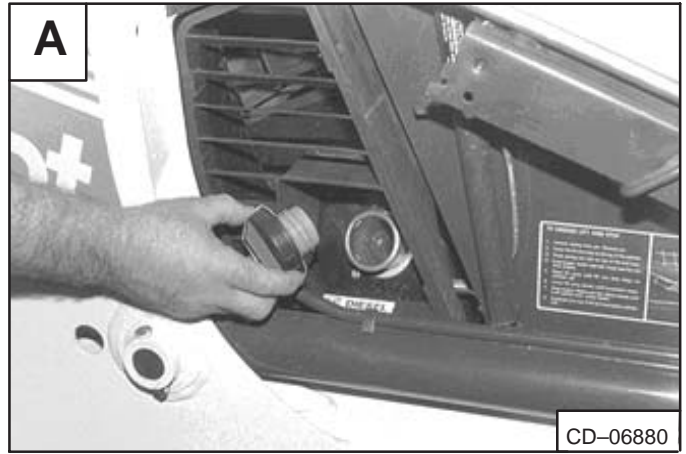

CD-06880

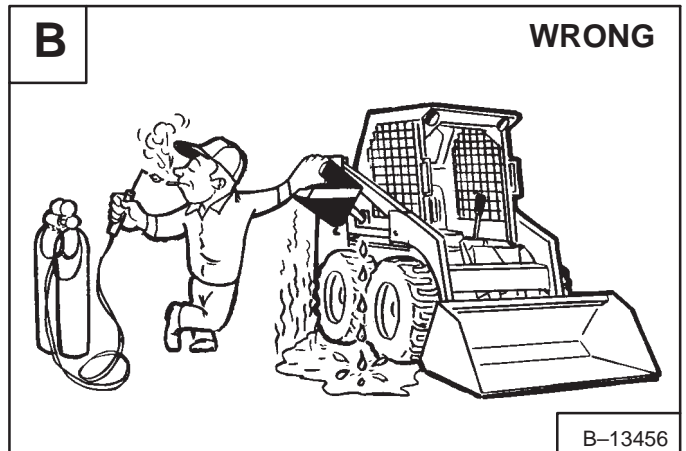

B-13456

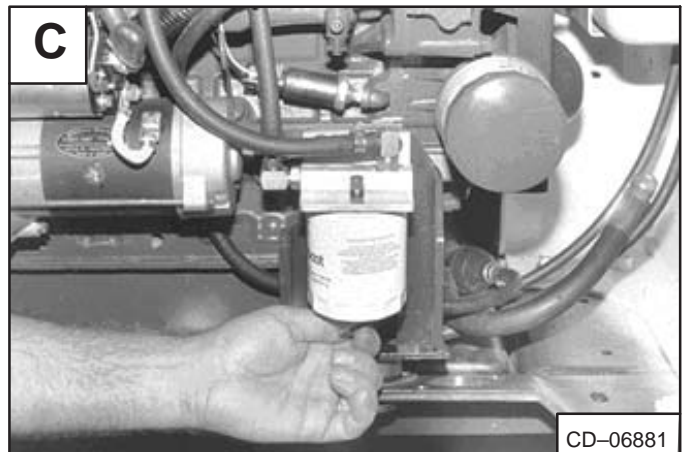

CD-06881

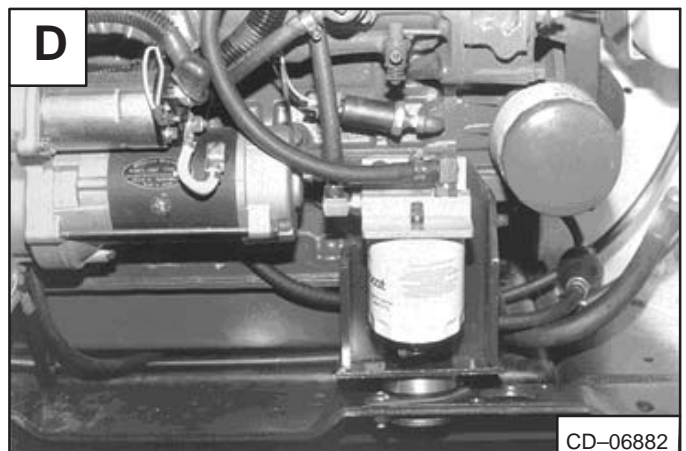

CD-06882

FUEL SYSTEM (Cont'd)

Clean the area around the filter housing. Put oil on the seal of the new filter element. Install the fuel filter.

Remove the air from the fuel system (See Below).

Removing Air from the Fuel System

After replacing the fuel filter element or when the fuel tank has run out of fuel, the air must be removed from the fuel system to start the engine.

Open the vent on the fuel filter housing **[A]**.

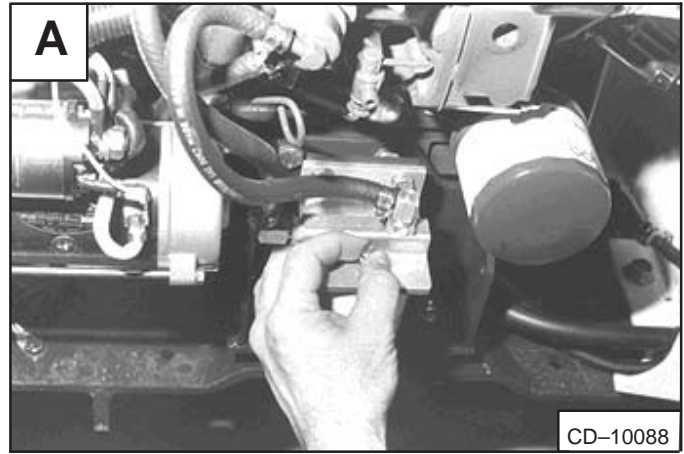

Operate the hand pump (priming bulb) until fuel flows from the vent with no air bubbles **[B]**.

Close the vent on the fuel filter housing **[A]**.

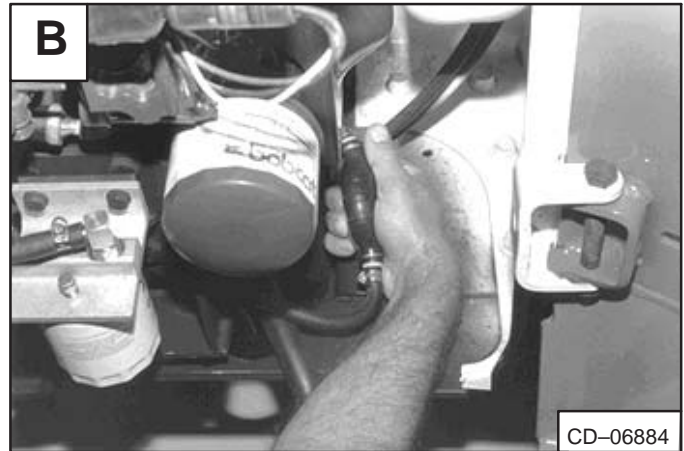

Open the vent on the fuel injection pump **[C]**.

Operate the hand pump (priming bulb) until the pump feels solid **[B]**.

Tighten the vent plug **[C]**.

Start the engine. It may be necessary to open the vent plug (at the injection pump) briefly until the engine runs smoothly.

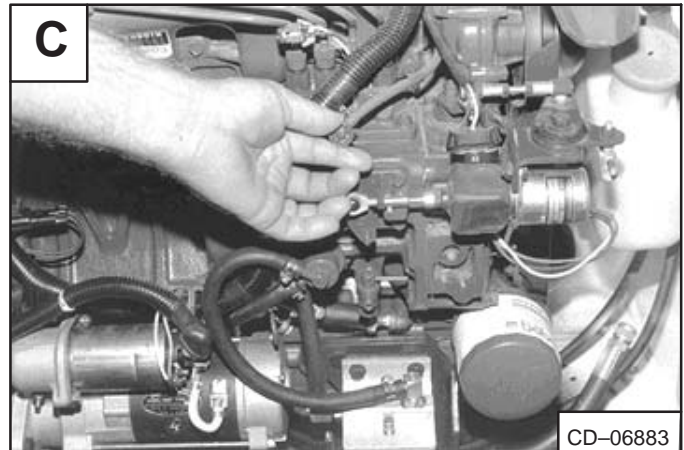

WARNING

Always clean up spilled fuel or oil. Keep heat, flames, sparks or lighted tobacco away from fuel and oil. Failure to use care around combustibles can cause explosion or fire which can result in injury or death.

W-2103-1285

ENGINE LUBRICATION SYSTEM

Checking Engine Oil

Check the oil level every day.

Before starting the engine for the work shift. Open the rear door. Remove the dipstick **[A]**.

Keep the oil level between the marks on the dipstick.

Use a good quality motor oil that meets API Service Classification of CC, CD or CE (See Oil Chart below).

RECOMMENDED SAE VISCOSITY NUMBER (LUBRICATION OILS FOR ENGINE CRANKCASE)

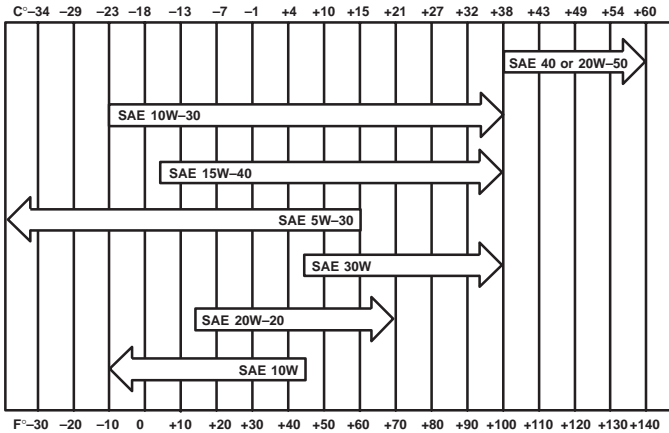

TEMPERATURE RANGE ANTICIPATED BEFORE
NEXT OIL CHANGE
(DIESEL: USE API CLASSIFICATION CC, CD OR CE)

Replacement of Oil and Filter

See the Service Schedule (Page 1-1) for the service interval for replacing the engine oil and filter.

1. Run the engine until it is at operating temperature. Stop the engine.
2. Open the rear door. Remove the drain plug **[B]**. Drain the oil into a container.
3. Remove the oil filter **[C]**.
4. Clean the filter housing surface. Put clean oil on the new oil filter gasket. Install the filter and hand tighten only.
5. Install and tighten the drain plug **[B]**.

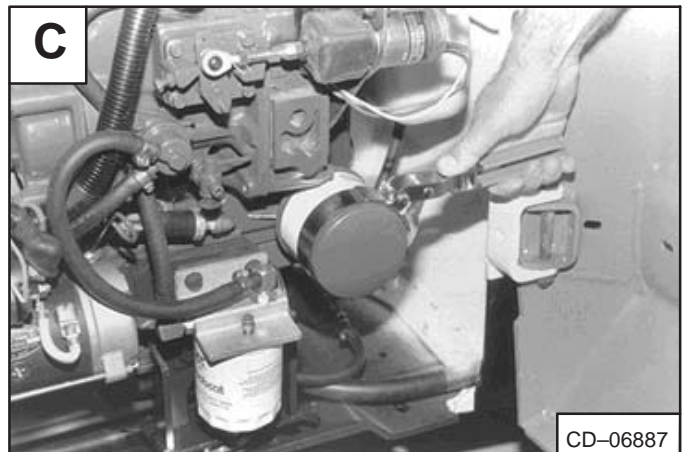
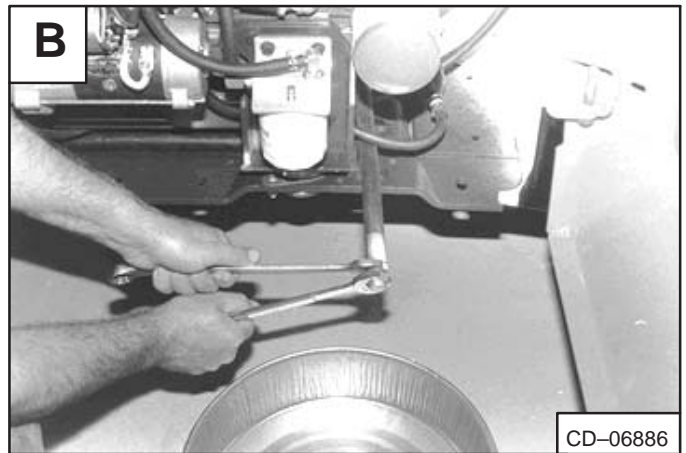
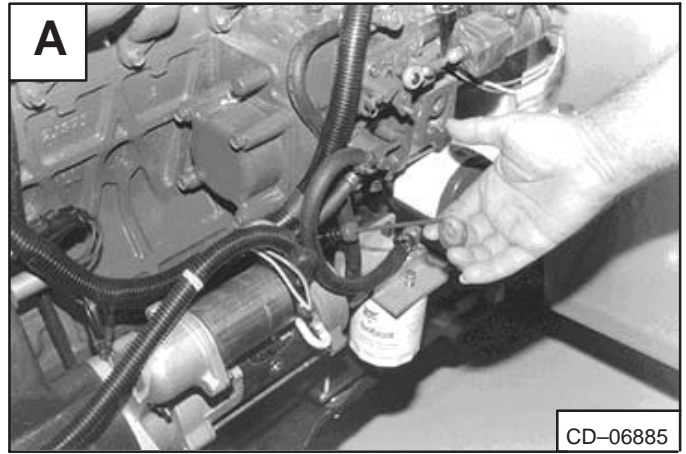

ENGINE LUBRICATION SYSTEM (Cont'd)

6. Remove the filler cap from the valve cover [A].

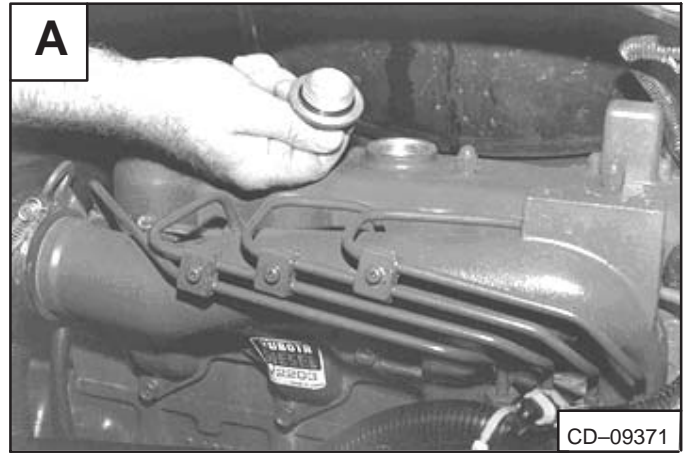

7. Put 7.5 qts (7,1 L) of oil in the engine (See Oil Chart, Page 1-11) [B].

8. Start the engine and let it run for several minutes. Stop the engine. Check for leaks and check the oil level. Add oil as needed if it is not at the top mark on the dipstick.

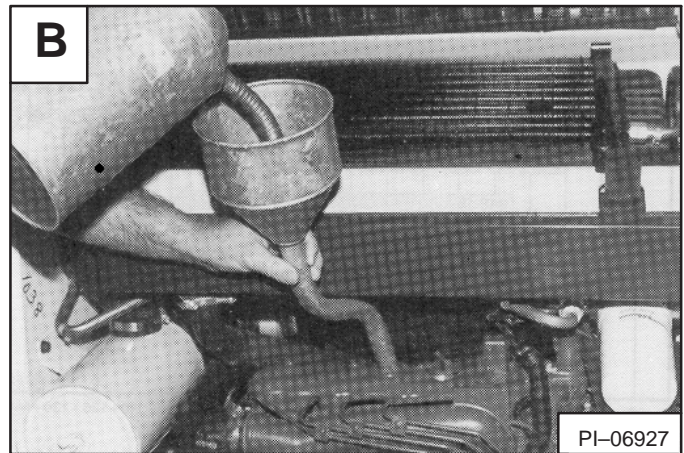

WARNING

Always clean up spilled fuel or oil. Keep heat, flames, sparks or lighted tobacco away from fuel and oil. Failure to use care around combustibles can cause explosion or fire which can result in injury or death.

W-2103-1285



Suggest:

If the above button click is invalid.

Please download this document

first, and then click the above link

to download the complete manual.

Thank you so much for reading

ENGINE COOLING SYSTEM

Cleaning the Cooling System

Check the cooling system every day to prevent over-heating, loss of performance or engine damage.

WARNING

Wear safety glasses to prevent eye injury when any of the following conditions exist:

- When fluids are under pressure.
- Flying debris or loose material is present.
- Engine is running.
- Tools are being used.

W-2019-1285

Raise the rear grill.

Use air pressure or water pressure to clean the top of the oil cooler **[A]**.

Raise the oil cooler and clean the top of the radiator **[B]**.

Check the cooling system for leaks.

Coolant Level

Open the rear door. Check the coolant level in the coolant recovery tank on the right side of the engine **[C]**.

The coolant recovery tank must be 1/3 full.

Add pre-mixed coolant, 50% water and 50% ethylene glycol to the recovery tank if the coolant level is low.

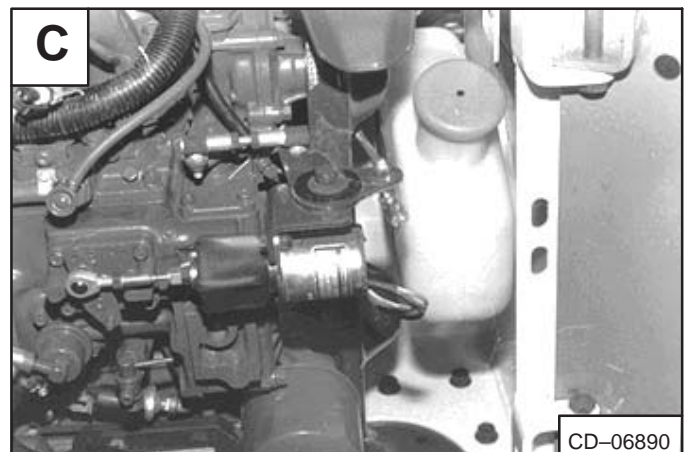
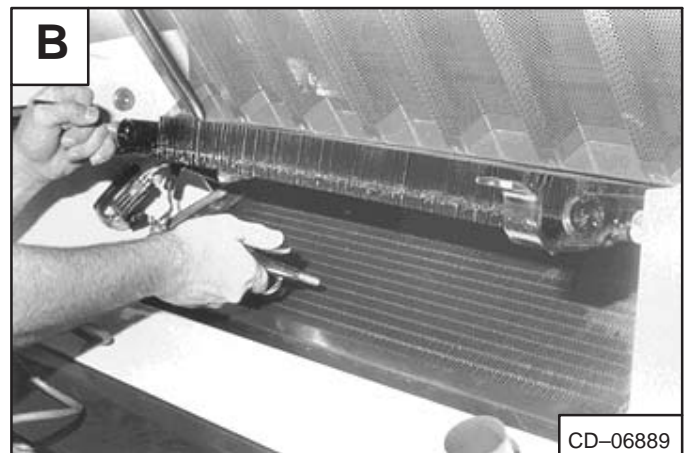
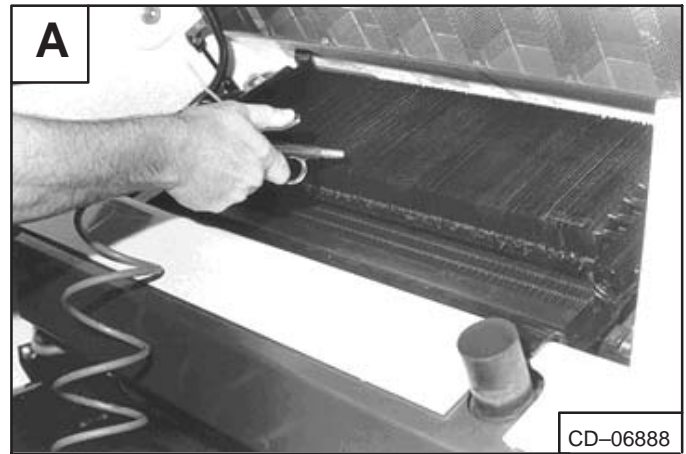

<https://www.ebooklibonline.com>

Hello dear friend!

Thank you very much for reading.

Enter the link into your browser.

The full manual is available for immediate download.

<https://www.ebooklibonline.com>