

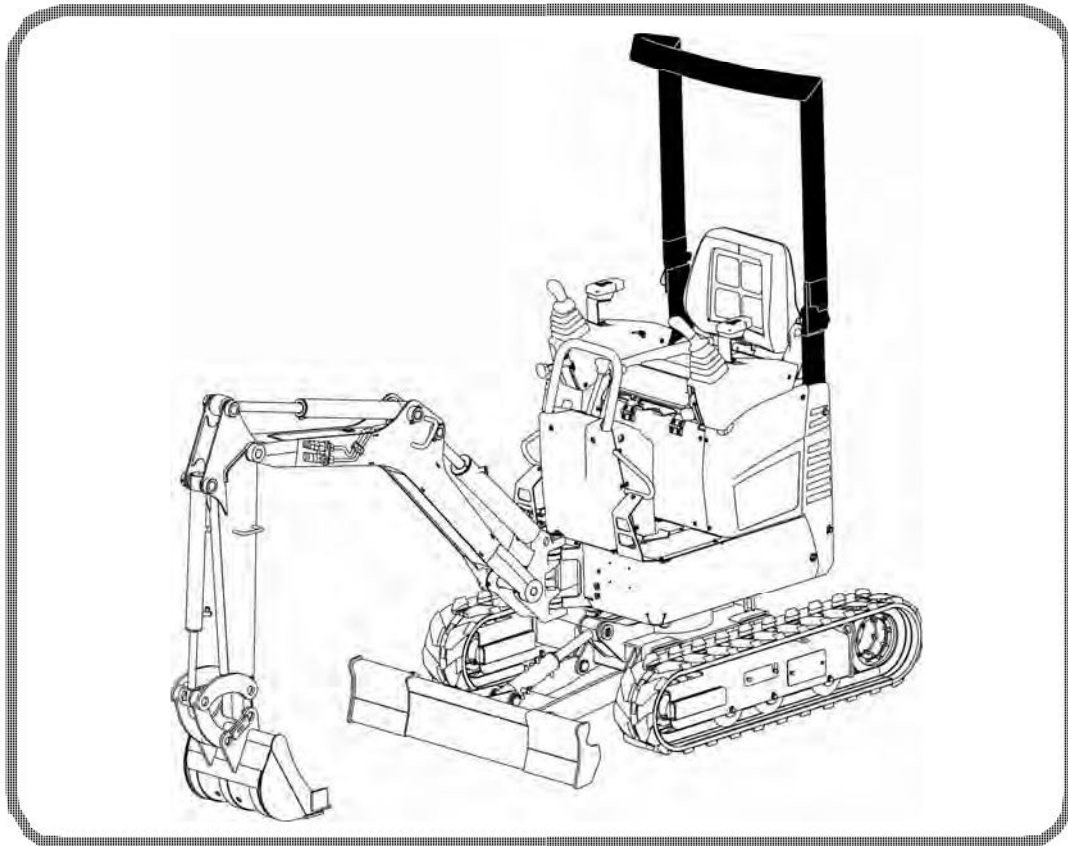

Bobcat®

Service Manual 418 Compact Excavator

S/N AB4711001 & Above
S/N B39211001 & Above



Dealer Copy -- Not for Resale



MAINTENANCE SAFETY

WARNING

Training is necessary before operating or servicing machine. Read and understand the Operation and Maintenance Manual, Operator's Handbook and signs (stickers) on machine. Follow warnings and instructions in the manuals when making repairs, adjustments or servicing. Check for correct function after adjustments, repairs or service. Untrained operators and failure to follow instructions can cause injury or death.

W-2003-0807

 **Safety Alert Symbol:** This symbol with a warning statement, means: "Warning, be alert! Your safety is involved!" Carefully read the message that follows.

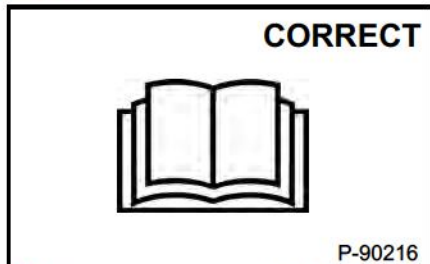

 Never service the Bobcat Compact Excavator without instructions.

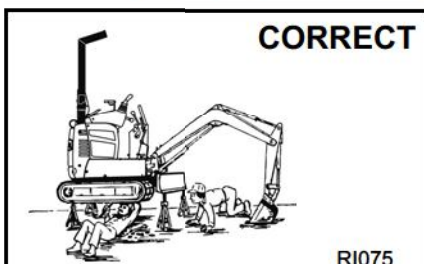

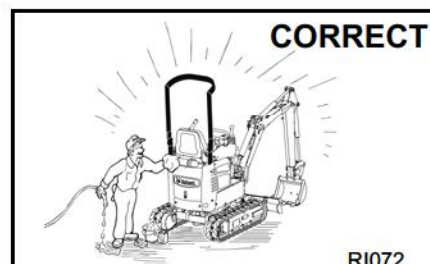

 Use the correct procedure to lift and support the excavator.



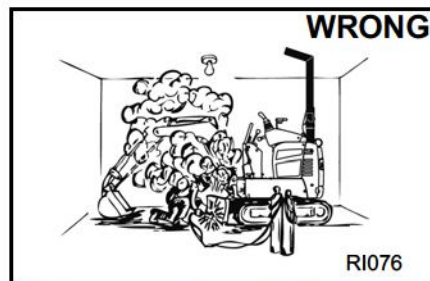

 Cleaning and maintenance are required daily.



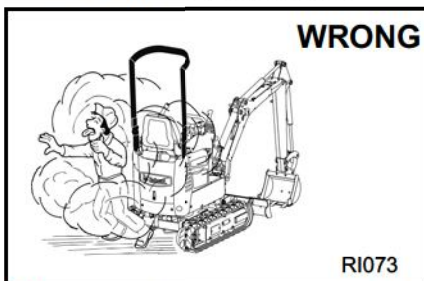

 Have good ventilation when welding or grinding painted parts.
 Wear dust mask when grinding painted parts. Toxic dust and gas can be produced.



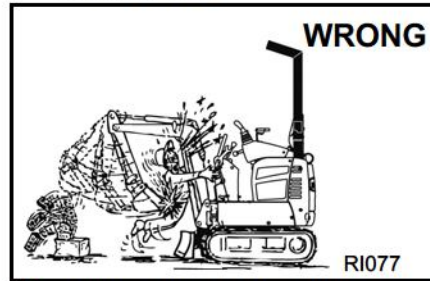



 Vent exhaust to outside when engine must be run for service.
 Exhaust system must be tightly sealed. Exhaust fumes can kill without warning.

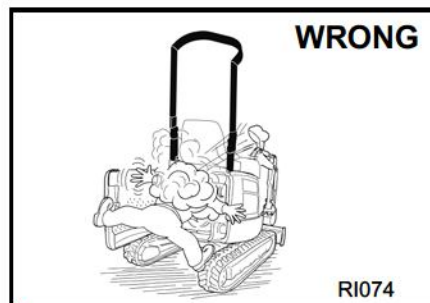



 Always lower the bucket and blade to the ground before doing any maintenance.
 Never modify equipment or add attachments not approved by Bobcat Company.



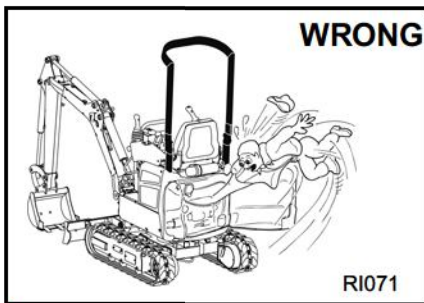



 Stop, cool and clean engine of flammable materials before checking fluids.
 Never service or adjust machine with the engine running unless instructed to do so in the manual.
 Avoid contact with leaking hydraulic fluid or diesel fuel under pressure. It can penetrate the skin or eyes.
 Never fill fuel tank with engine running, while smoking, or when near open flame.

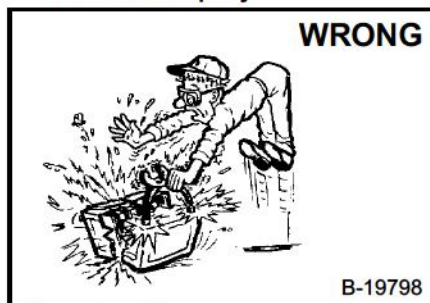

 Keep body, jewellery and clothing away from moving parts, electrical contact, hot parts and exhaust.
 Wear eye protection to guard from battery acid, compressed springs, fluids under pressure and flying debris when engines are running or tools are used. Use eye protections approved for type of welding.
 Keep tailgate closed except for service. Close and latch tailgate before operating the excavator.



 Lead-acid batteries produce flammable and explosive gases.
 Keep arcs, sparks, flames and lighted tobacco away from batteries.
 Batteries contain acid which burns eyes or skin on contact.
 Wear protective clothing. If acid contacts body, flush well with water. For eye contact flush well and get immediate medical attention.

Maintenance procedures which are given in the Operation and Maintenance Manual can be performed by the owner/operator without any specific technical training. Maintenance procedures which are not in the Operation and Maintenance Manual must be performed **ONLY BY QUALIFIED BOBCAT SERVICE PERSONNEL**. Always use genuine Bobcat replacement parts.

Dealer Copy -- Not for Resale

CONTENTS

SAFETY AND MAINTENANCE	10-01
HYDRAULIC SYSTEM	20-01
UNDERCARRIAGE	30-01
UPPERSTRUCTURE AND SWING SECTION	40-01
ELECTRICAL SYSTEM & ANALYSIS	50-01
ENGINE SERVICE	60-01
SPECIFICATIONS	SPEC-01
ALPHABETICAL INDEX	INDEX-01

FOREWORD

FOREWORD	1-7
SAFETY INSTRUCTIONS	1-9
FIRE PREVENTION	1-11
Maintenance	1-11
Operation	1-11
Electrical	1-11
Hydraulic System	1-11
Fueling	1-11
Starting	1-11
Spark Arrester Exhaust System	1-11
Welding And Grinding	1-12
Fire Extinguishers	1-12
SERIAL NUMBER LOCATIONS	1-13
Excavator Serial Number	1-13
Engine Serial Number	1-13
DELIVERY REPORT	1-14
BOBCAT EXCAVATOR IDENTIFICATION	1-15

Dealer Copy -- Not for Resale

<https://www.ebooklibonline.com>

Hello dear friend!

Thank you very much for reading.

Enter the link into your browser.

The full manual is available for immediate download.

<https://www.ebooklibonline.com>

FOREWORD

This manual is for the Bobcat excavator mechanic. It provides necessary servicing and adjustment procedures for the Bobcat excavator and its component parts and systems. Refer to the Operation & Maintenance Manual for operating instructions, starting procedure, daily checks, etc.

A general inspection of the following items must be made after the excavator has had service or repair:

1. Check that the fold-down TOPS is in good condition and is not modified.

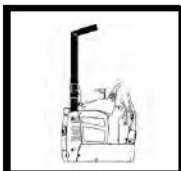

2. Check that fold-down TOPS mounting hardware is tightened and is Bobcat approved.



3. The seat belt must be correctly installed, functional and in good condition.

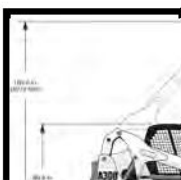

4. Machine signs (decals) must be legible and in the correct location.



5. Travel levers, control levers and foot pedals must return to neutral. Check that the pedal locks are in working order.



6. Check for correct function of the work lights.



7. Attachment locking pins must function correctly and be in good condition.

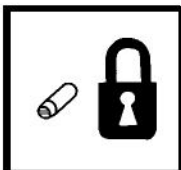

8. Safety treads must be in good condition.

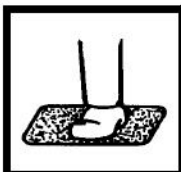

9. Check for correct function of indicator lamps.

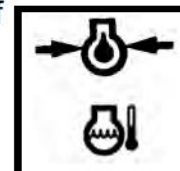

10. Check hydraulic fluid level, engine oil level and fuel supply.



11. Inspect for fuel, oil or hydraulic fluid leaks.

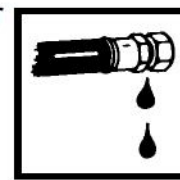

12. Lubricate the excavator.



13. Check the condition of the battery and cables.

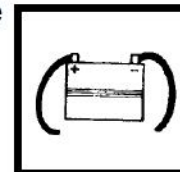

14. Inspect the air cleaner for damage or leaks. Check the condition of the element.

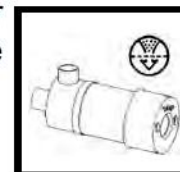

15. Check the electrical charging system.

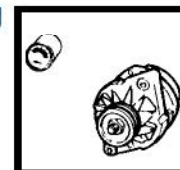

16. Check tracks for wear and tension. Use only approved tracks.

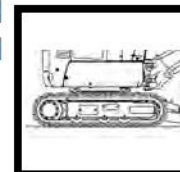

Dealer Copy -- Not for Resale

FW EXC UC-0508 SM

17. Inspect for loose or broken parts or connections.



20. Check the control console interlocks for correct function.

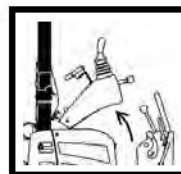

18. Check for any field modification not completed.



21. Check function or condition of all equipped options and accessories (examples: boom light, motion alarm, etc.).



19. Operate the machine and check all functions.



22. Recommend to the owner that all necessary corrections be made before the machine is returned to service.



**CALIFORNIA
PROPOSITION 65 WARNING**
Diesel engine exhaust and some of its constituents are known to the state of California to cause cancer, birth defects and other reproductive harm.

SAFETY INSTRUCTIONS



Safety Alert Symbol

This symbol with a warning statement means:
"Warning, be alert! Your safety is involved!"
Carefully read the message that follows.



WARNING

AVOID INJURY OR DEATH

Instructions are necessary before operating or servicing machine. Read and understand the Operation & Maintenance Manual, Operator's Handbook and signs (decals) on machine. Follow warnings and instructions in the manuals when making repairs, adjustments or servicing. Check for correct function after adjustments, repairs or service. Untrained operators and failure to follow instructions can cause injury or death.

W-2003-0807

IMPORTANT

This notice identifies procedures which must be followed to avoid damage to the machine.

I-2019-0284



DANGER

The signal word DANGER on the machine and in the manuals indicates a hazardous situation which, if not avoided, will result in death or serious injury.

D-1002-1107



WARNING

The signal word WARNING on the machine and in the manuals indicates a potentially hazardous situation which, if not avoided, could result in death or serious injury.

W-2044-1107

The following publications provide information on the safe use and maintenance of the Bobcat machine and attachments:

- The Delivery Report is used to assure that complete instructions have been given to the new owner and that the machine is in safe operating condition.
- The Operation & Maintenance Manual delivered with the machine or attachment contains operating information as well as routine maintenance and service procedures. It is a part of the machine and can be stored in a container provided on the machine. Replacement Operation & Maintenance Manuals can be ordered from your Bobcat dealer.
- Machine signs (decals) instruct on the safe operation and care of your Bobcat machine or attachment. The signs and their locations are shown in the Operation & Maintenance Manual. Replacement signs are available from your Bobcat dealer.
- An Operator's Handbook fastened to the operator cab. It's brief instructions are convenient to the operator. The handbook is available from your dealer in an English edition or one of many other languages. See your Bobcat dealer for more information on translated versions.
- The AEM Safety Manual delivered with the machine gives general safety information.
- The Service Manual and Parts Manual are available from your dealer for use by mechanics to do shop-type service and repair work.
- The Compact Excavator Operator Training Course is available through your local dealer or at www.training.bobcat.com or www.bobcat.com. This course is intended to provide rules and practices of correct operation of the Bobcat excavator. The course is available in English and Spanish versions.
- Service Safety Training Courses are available from your Bobcat dealer or at www.training.bobcat.com or www.bobcat.com. They provide information for safe and correct service procedures.
- The Bobcat compact excavator Safety Video is available from your Bobcat dealer or at www.training.bobcat.com or www.bobcat.com.

Dealer Copy -- Not for Resale

SI EXC-0913 SM

FIRE PREVENTION



Maintenance

The machine and some attachments have components that are at high temperatures under normal operating conditions. The primary source of high temperatures is the engine and exhaust system. The electrical system, if damaged or incorrectly maintained, can be a source of arcs or sparks.

Flammable debris (leaves, straw, etc.) must be removed regularly. If flammable debris is allowed to accumulate, it can cause a fire hazard. Clean often to avoid this accumulation. Flammable debris in the engine compartment is a potential fire hazard.

The operator's area, engine compartment and engine cooling system must be inspected every day and cleaned if necessary to prevent fire hazards and overheating.

All fuels, most lubricants and some coolants mixtures are flammable. Flammable fluids that are leaking or spilled onto hot surfaces or onto electrical components can cause a fire.

Operation

Do not use the machine where exhaust, arcs, sparks or hot components can contact flammable material, explosive dust or gases.

Electrical



Check all electrical wiring and connections for damage. Keep the battery terminals clean and tight. Repair or replace any damaged part or wires that are loose or frayed.

Battery gas can explode and cause serious injury. Use the procedure in the Operation & Maintenance Manual for connecting the battery and for jump starting. Do not jump start or charge a frozen or damaged battery. Keep any open flames or sparks away from batteries. Do not smoke in battery charging area.

Hydraulic System

Check hydraulic tubes, hoses and fittings for damage and leakage. Never use open flame or bare skin to check for leaks. Hydraulic tubes and hoses must be properly routed and have adequate support and secure clamps. Tighten or replace any parts that show leakage.

Always clean fluid spills. Do not use gasoline or diesel fuel for cleaning parts. Use commercial nonflammable solvents.

Fueling



Stop the engine and let it cool before adding fuel. No smoking! Do not refuel a machine near open flames or sparks. Fill the fuel tank outdoors.

Ultra Low Sulfur Diesel (ULSD) poses a greater static ignition hazard than earlier diesel formulations with higher Sulfur content. Avoid death or serious injury from fire or explosion. Consult with your fuel or fuel system supplier to ensure the delivery system is in compliance with fueling standards for proper grounding and bonding practices.

Starting

Do not use ether or starting fluids on any engine that has glow plugs. These starting aids can cause explosion and injure you or bystanders.

Use the procedure in the Operation & Maintenance Manual for connecting the battery and for jump starting.

Spark Arrester Exhaust System

The spark arrester exhaust system is designed to control the emission of hot particles from the engine and exhaust system, but the muffler and the exhaust gases are still hot.

Check the spark arrester exhaust system regularly to make sure it is maintained and working properly. Use the procedure in the Operation & Maintenance Manual for cleaning the spark arrester muffler (if equipped).

Dealer Copy -- Not for Resale

SI EXC-0913 SM

FIRE PREVENTION (CONT'D)

Welding And Grinding

Always clean the machine and attachment, disconnect the battery, and disconnect the wiring from the Bobcat controllers before welding. Cover rubber hoses, battery and all other flammable parts. Keep a fire extinguisher near the machine when welding.

Have good ventilation when grinding or welding painted parts. Wear dust mask when grinding painted parts. Toxic dust or gas can be produced.

Dust generated from repairing nonmetallic parts such as hoods, fenders or covers can be flammable or explosive. Repair such components in a well ventilated area away from open flames or sparks.

Fire Extinguishers



Know where fire extinguishers and first aid kits are located and how to use them. Inspect the fire extinguisher and service the fire extinguisher regularly. Obey the recommendations on the instructions plate.

SERIAL NUMBER LOCATIONS

Always use the serial number of the excavator when requesting service information or when ordering parts. Early or later models (identification made by serial number) may use different parts, or it may be necessary to use a different procedure in doing a specific service operation.

Excavator Serial Number

Figure 1

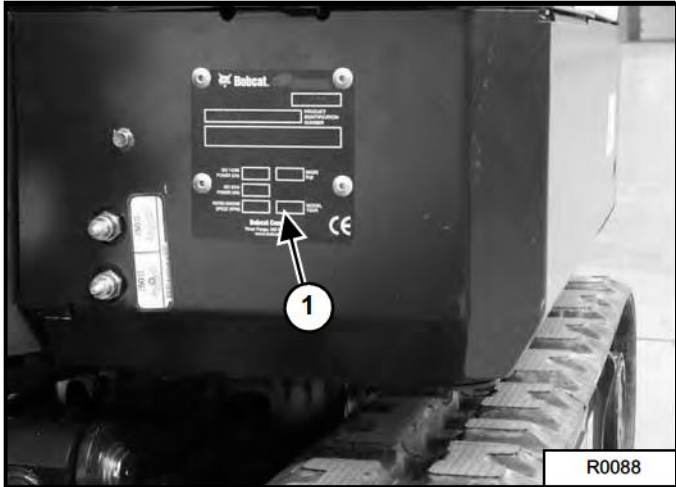

The excavator serial number plate (Item 1) [Figure 1] is located on the front left hand corner of the frame.

Figure 2

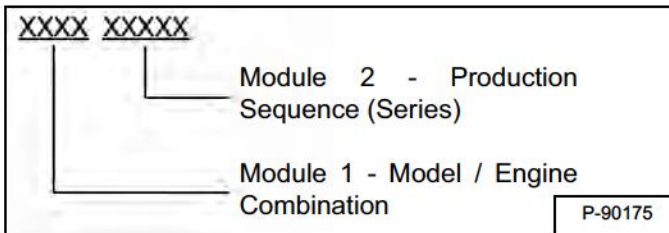

Explanation of excavator Serial Number [Figure 2]:

1. The four digit Model / Engine Combination Module number identifies the model number and engine combination.
2. The five digit Production Sequence Number identifies the order which the excavator is produced.

Engine Serial Number

Figure 3



The engine serial number is located as a plate (Item 1) on top of the engine [Figure 3].

Figure 4

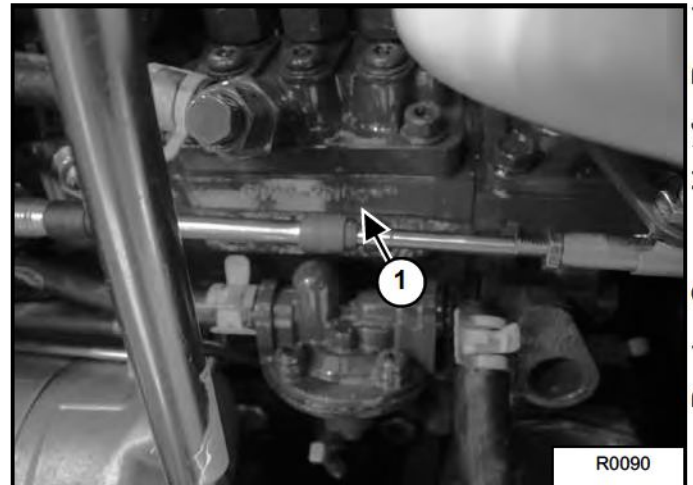

The engine serial number also appears engraved on the side of the engine (Item 1) [Figure 4].

Dealer Copy -- Not for Resale

DELIVERY REPORT

Figure 5

The diagram shows a form layout with the following sections:

- DELIVERY REPORT**: A box at the top right containing a list of items.
- WARNING**: A large section below the delivery report, containing multiple lines of text.
- B-16315**: A small box at the bottom right of the form.

The delivery report **[Figure 5]** contains a list of items that must be explained or shown to the owner or operator by the dealer when the Bobcat excavator is delivered.

The delivery report must be reviewed and signed by the owner or operator and the dealer.

BOBCAT EXCAVATOR IDENTIFICATION

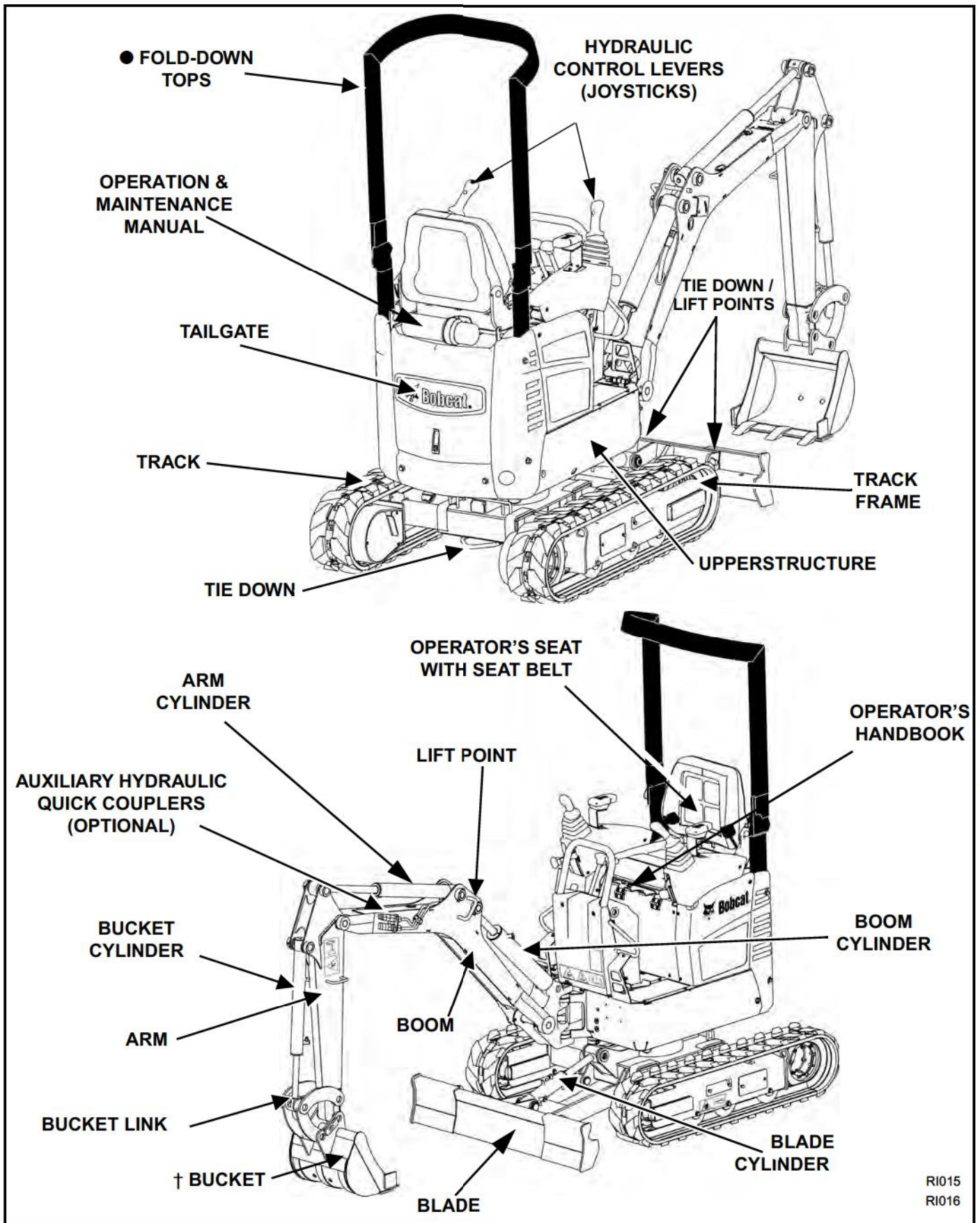

Dealer Copy -- Not for Resale

† BUCKET - Several different buckets and other attachments are available for the Bobcat excavator.
 ● TOPS (Tip-Over Protective Structure) as standard equipment. The TOPS meets ISO 12117.

RI015
RI016

SAFETY AND MAINTENANCE

LIFTING AND BLOCKING THE EXCAVATOR	10-10-1
Procedure	10-10-1
UPPERSTRUCTURE SLEW LOCK	10-20-1
Operation	10-20-1
LIFTING THE EXCAVATOR	10-30-1
Procedure	10-30-1
TRANSPORTING THE EXCAVATOR ON A TRAILER	10-40-1
Loading And Unloading	10-40-1
Fastening	10-40-2
FOLD-DOWN TOPS	10-50-1
TOPS Position	10-50-1
Lowering The Fold-Down TOPS	10-50-1
Raising The Fold-Down TOPS	10-50-2
TAILGATE	10-60-1
Opening And Closing	10-60-1
SERVICE SCHEDULE	10-70-1
Chart	10-70-1
AIR CLEANER SERVICE	10-80-1
Daily Check	10-80-1
Replacing The Filter Elements	10-80-1
ENGINE COOLING SYSTEM	10-90-1
Cleaning	10-90-1
Checking Level	10-90-1
Removing And Replacing The Coolant	10-90-2
FUEL SYSTEM	10-100-1
Fuel Specifications	10-100-1
Biodiesel Blend Fuel	10-100-1
Filling The Fuel Tank	10-100-2
Fuel Filters	10-100-2
Draining The Fuel Tank	10-100-2
Removing Air From The Fuel System	10-100-3
ENGINE LUBRICATION SYSTEM	10-110-1
Checking And Adding Engine Oil	10-110-1
Engine Oil Chart	10-110-1
Removing And Replacing Oil And Filter	10-110-2

Dealer Copy -- Not for Resale

HYDRAULIC SYSTEM	10-120-1
Checking And Adding Hydraulic Oil	10-120-1
Hydraulic / Hydrostatic Fluid Chart	10-120-1
Removing And Replacing Hydraulic Filter	10-120-2
Removing And Replacing Hydraulic Fluid	10-120-3
LUBRICATING THE EXCAVATOR	10-130-1
Lubrication Locations	10-130-1
TRAVEL MOTOR	10-140-1
Checking And Adding Oil	10-140-1
Removing And Replacing Oil	10-140-1
SPARK ARRESTER MUFFLER	10-150-1
Cleaning Procedure	10-150-1
ALTERNATOR BELT	10-160-1
Belt Adjustment	10-160-1
Belt Replacement	10-160-2
SEAT BELT	10-170-1
Inspection And Maintenance	10-170-1
CONTROL CONSOLE LOCKOUT	10-180-1
Inspection And Maintenance	10-180-1
EXCAVATOR STORAGE AND RETURN TO SERVICE	10-190-1
Storage	10-190-1
Return To Service	10-190-1
STOPPING THE ENGINE AND LEAVING THE EXCAVATOR	10-200-1
Procedure	10-200-1
MOTION ALARM	10-210-1
Description	10-210-1
Inspecting	10-210-1
Adjusting Switch Position	10-210-2
REMOTE START TOOL KIT - MEL1563	10-220-1
Remote Start Tool - MEL1563	10-220-1
Service Tool Harness Communicator - MEL1566	10-220-3
REMOTE START TOOL (SERVICE TOOL) KIT - 7003031	10-221-1
Description	10-221-1
Remote Start Tool (Service Tool) - 7003030	10-221-2
Excavator Service Tool Harness - 6689747	10-221-3
Computer Service Tool Harness - 6689746	10-221-4

LIFTING AND BLOCKING THE EXCAVATOR

Procedure

Always park the machine on a level surface.

Figure 10-10-1



Raise one side of the machine (approximately 4 inches) using the boom and arm as shown in [Figure 10-10-1].

Figure 10-10-2

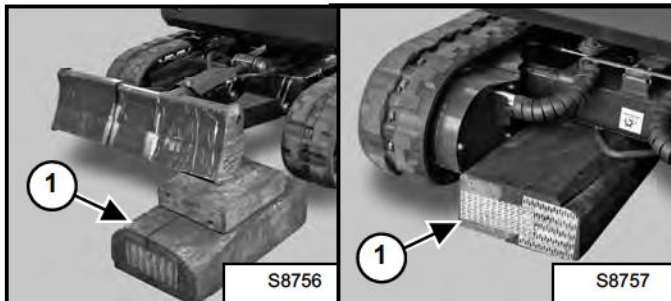

Raise the blade fully and install wooden blocks (Item 1) [Figure 10-10-2] or jackstands under the blade and the track frame. Lower the machine until all machine weight is on the wooden blocks or jackstands.

Rotate the upperstructure 180° and repeat procedure for other side.

Figure 10-10-3

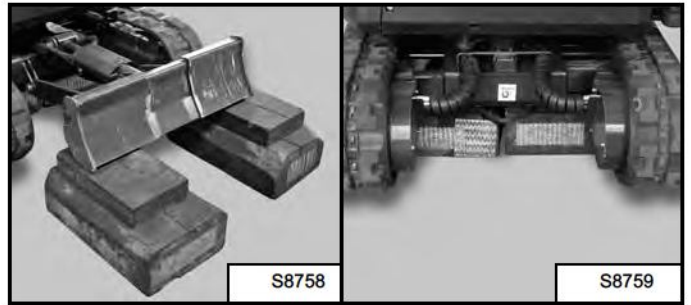

The machine must be blocked up as shown in [Figure 10-10-3].

Stop the engine.



Put jackstands under the blade and rear corners of the undercarriage before working under the machine. Failure to block up the machine may allow it to move or fall and result in injury or death.

W-2218-1195



AVOID INJURY

Keep fingers and hands out of pinch points when checking the track tension.

W-2142-0903

Dealer Copy -- Not for Resale

UPPERSTRUCTURE SLEW LOCK

Operation

Figure 10-20-1

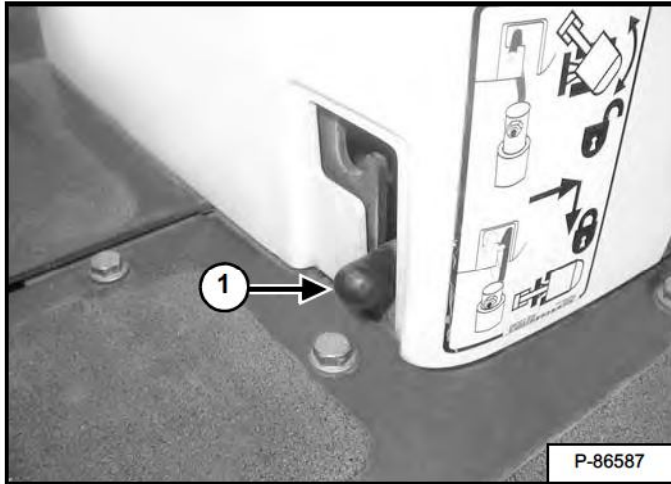

Move the slow lock pin (Item 1) [Figure 10-20-1] to the right and down to engage the Upperstructure Slew Lock. When the Slew Lock is engaged (locked), the upperstructure of the excavator is locked to the track frame and will not rotate.

NOTE: The upperstructure must be in the straight forward or straight backward position for the upperstructure to lock.

Move the slow lock pin (Item 1) [Figure 10-20-1] up and to the left to disengage the upperstructure from the track frame. Fit the lever properly to fully disengage the Slew Lock.

WARNING

AVOID INJURY

The upperstructure slew lock lever must be engaged when transporting the machine.

W-2197-0904

LIFTING THE EXCAVATOR

Procedure

Fully extend the cylinders of the bucket, arm and boom.

Raise the blade all the way.

Turn the upper structure so that the boom is at the opposite end as the blade.

Put all the controls in neutral and engage the slew lock. (See UPPERSTRUCTURE SLEW LOCK on Page 10-20-1.)

WARNING

AVOID INJURY OR DEATH

- Use a lifting fixture with sufficient capacity for the weight of the excavator plus any added attachments.
- Maintain center of gravity and balance when lifting.
- Do not swing boom or upperstructure. Engage the upperstructure slew lock.
- Never lift with operator on machine.

W-2202-0607

Figure 10-30-2

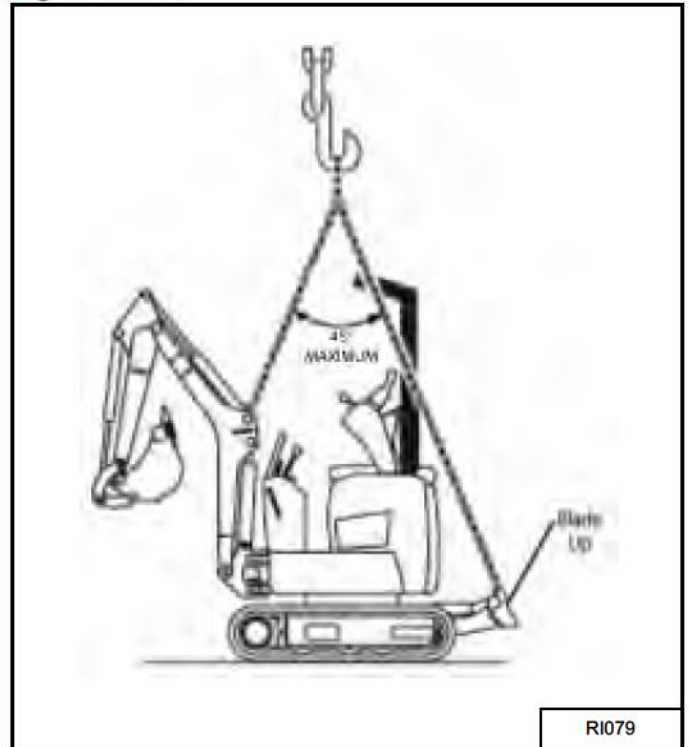

The maximum angle between the front and rear chains must not exceed 45° [Figure 10-30-2].

Figure 10-30-1

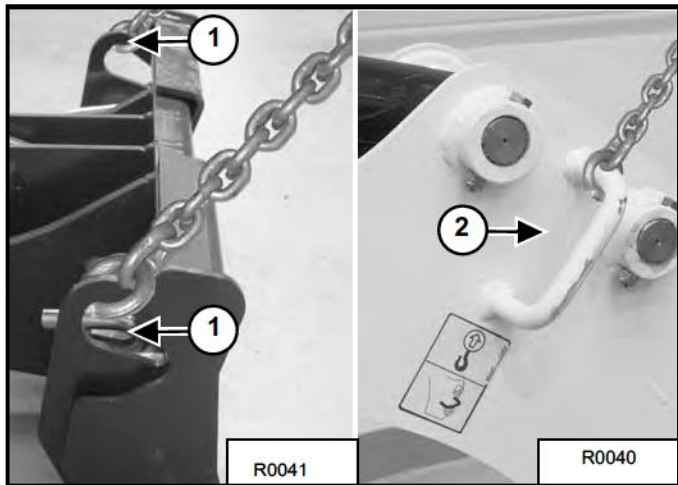

Fasten the chains to the ends of the blade (Item 1) [Figure 10-30-1] and up to a lifting fixture above the canopy.

Fasten a chain in the hook of the boom (Item 2) [Figure 10-30-1].

Dealer Copy -- Not for Resale

TRANSPORTING THE EXCAVATOR ON A TRAILER

Loading And Unloading

When transporting the machine, observe the rules, motor vehicle laws and vehicle limit ordinances. Use a transportation and towing vehicle of adequate length and capacity.

Secure the brakes and block the wheels of the transport vehicle.

Align the ramps with the center of the transport vehicle. Secure the ramps to the truck (or trailer) bed and be sure ramp angle does not exceed 15 degrees.

Use metal loading ramps with a slip resistant surface.

Use ramps that are the correct length and width, and can support the weight of the machine.

The rear of the trailer must be blocked or supported when loading or unloading the excavator to prevent the front of the transport vehicle from raising.

Determine the direction of the track movement before moving the machine (blade forward). Engage the upperstructure slew lock. (See UPPERSTRUCTURE SLEW LOCK on Page 10-20-1.)

Figure 10-40-1



Move the machine forward onto the transport vehicle [Figure 10-40-1].

Do not change direction of the machine while it is on the ramps.

Lower the boom, arm, bucket and blade to the transport vehicle.

Stop the engine and remove the key.

Put blocks under the front and rear of the tracks shoes.

Dealer Copy -- Not for Resale

TRANSPORTING THE EXCAVATOR (CONT'D)

Fastening

Figure 10-40-2

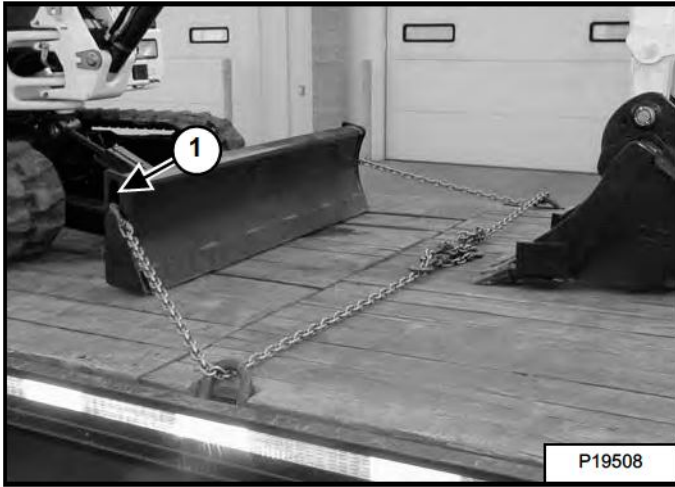

Figure 10-40-3

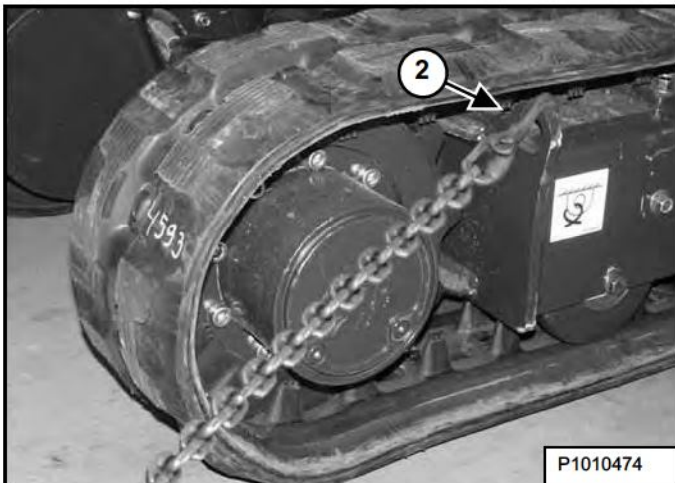
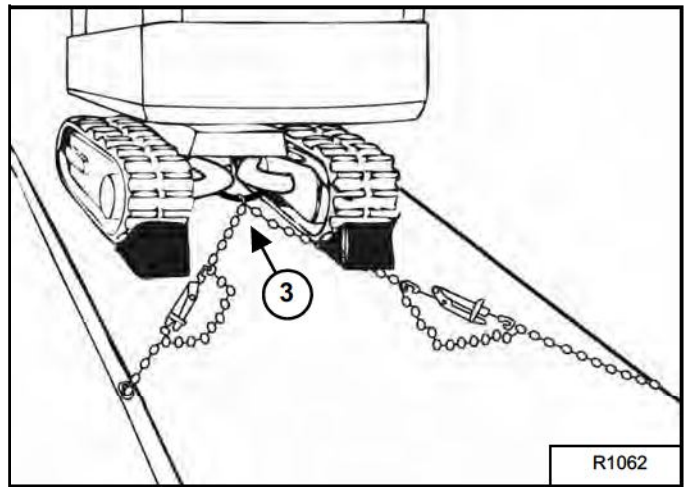

Figure 10-40-4



Fasten chains to the front corners of the blade (Item 1) [Figure 10-40-2], to both sides of the tracks (Item 2) [Figure 10-40-3] and to the tie down loop at the rear of the track frame (Item 3) [Figure 10-40-4].

Use chain binders to tighten the chains and then safely tie the chain binder levers to prevent loosening.

! WARNING

AVOID SERIOUS INJURY OR DEATH

Adequately designed ramps of sufficient strength are needed to support the weight of the machine when loading onto a transport vehicle. Wood ramps can break and cause personal injury.

W-2058-0807

FOLD-DOWN TOPS

TOPS Position



AVOID INJURY OR DEATH

Use the Tip Over Protective Structure (TOPS). TOPS changes not approved by Bobcat Company can cause loss of operator protection and result in injury or death. The TOPS must be in the raised position with the seat belt fastened. There is no tip-over protection when the TOPS is in the lowered position.

W-2742-0608

The excavator can be operated temporarily with the TOPS lowered for access through height restricted openings. Do not fasten seat belt when the TOPS is in the DOWN position.

Stop the engine, exit the machine and put the TOPS in the UP and LOCKED position after passing through height restricted opening.

Lowering The Fold-Down TOPS

Figure 10-50-1

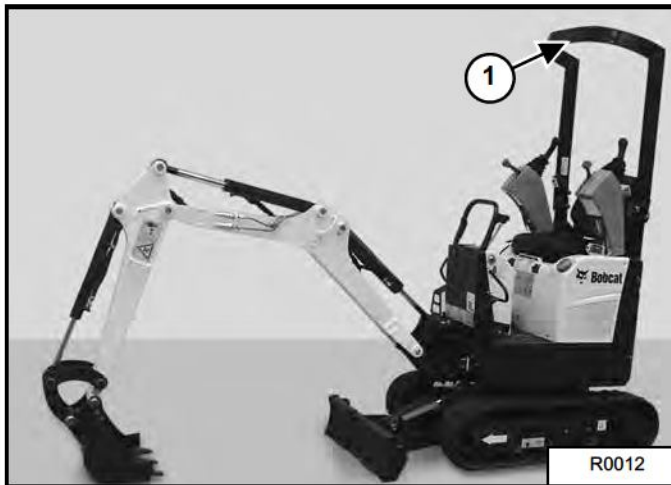

The excavator is equipped with a Tip-Over Protective Structure (TOPS) (Item 1) [Figure 10-50-1].

Figure 10-50-2

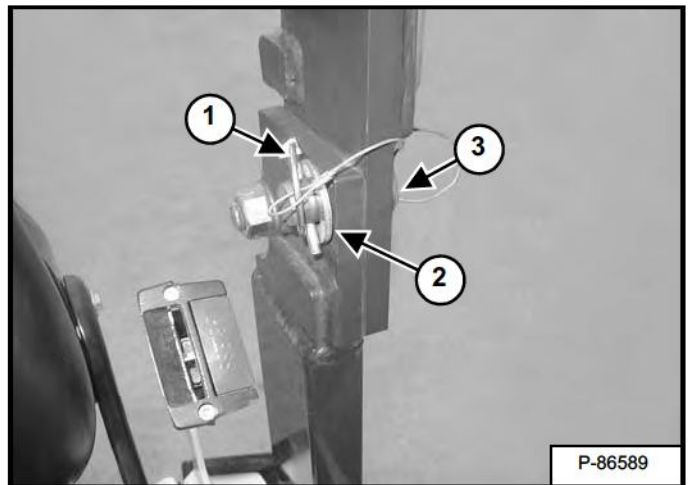

Remove the retainer clip (Item 1) and washer (Item 2) [Figure 10-50-2] (both sides).

Figure 10-50-3

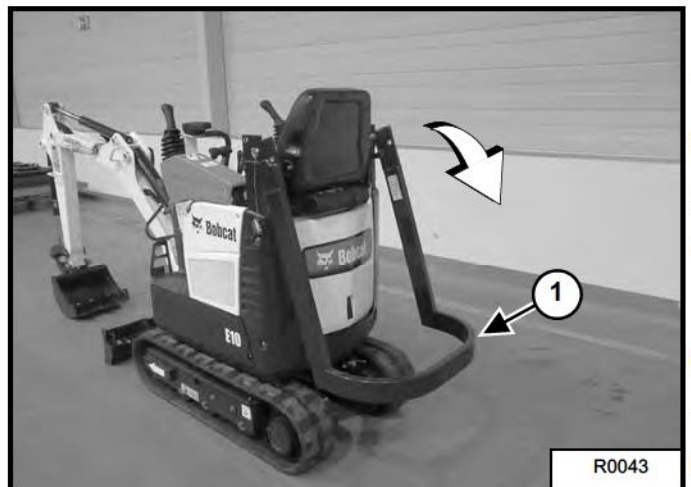

Securely grasp the TOPS (Item 1) [Figure 10-50-1] with one hand and remove the pin (Item 3) [Figure 10-50-2] (both sides) and lower the TOPS (Item 1) [Figure 10-50-3] to the down position.

Dealer Copy -- Not for Resale

FOLD-DOWN TOPS (CONT'D)

Lowering The Fold-Down TOPS (Cont'd)

Figure 10-50-4

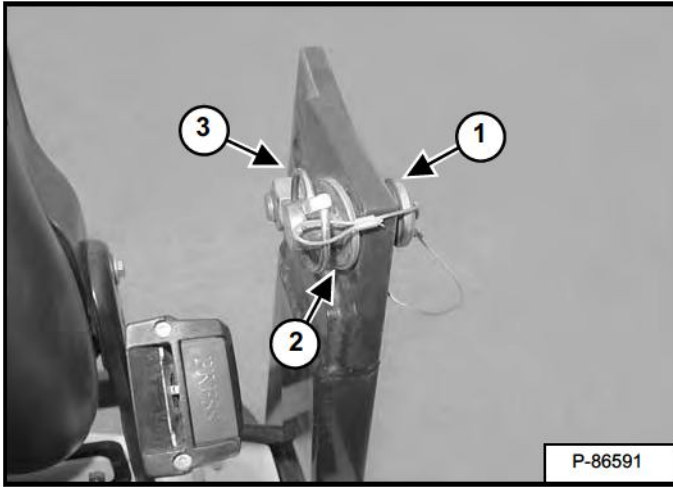

Reinstall the pin (Item 1) and the washer (Item 2) on the retainer clip (Item 3) [Figure 10-50-4] into the TOPS for storage.

Raising The Fold-Down TOPS

Figure 10-50-5

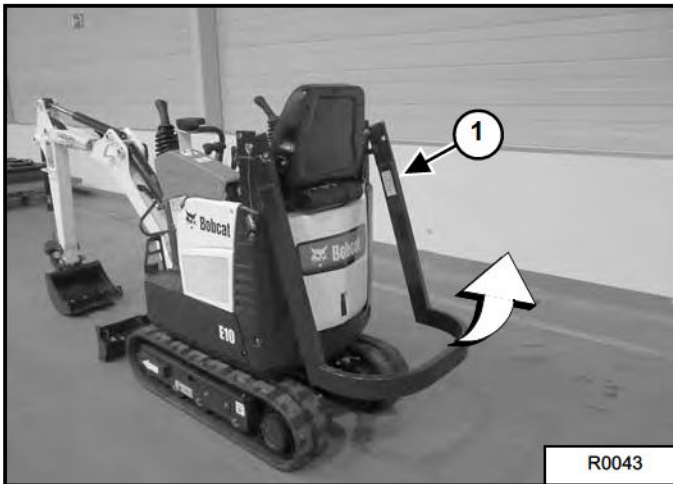

Remove the retainer clip (Item 3) and the washer (Item 2) from the pin (Item 1) [Figure 10-50-4] (both sides).

Securely grasp the TOPS (Item 1) [Figure 10-50-5] and raise to the upright position and install the pin (Item 1) [Figure 10-50-6] (both sides).

Figure 10-50-6

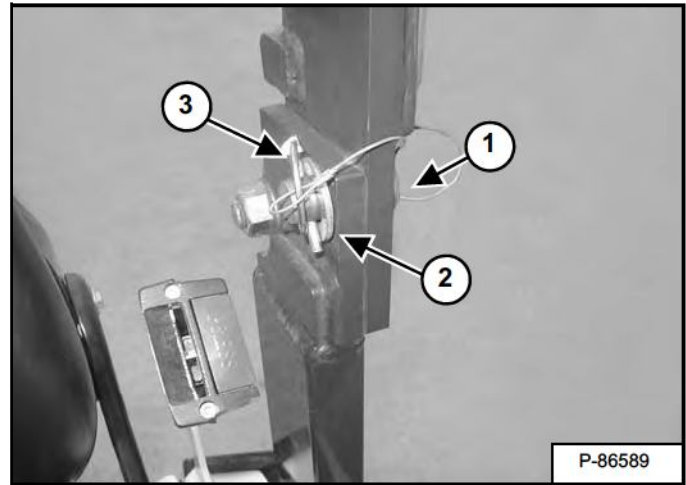

Install the washer (Item 2) and the retainer clip (Item 3) [Figure 10-50-6] (both sides).

WARNING

AVOID INJURY OR DEATH

The Tip Over Protective Structure (TOPS) must be properly secured in the raised position. Make sure the pins are correctly installed through the mounting frame and the TOPS tube and secured with the retainer pins. Improperly installed fasteners will cause loss of TOPS protection.

W-2753-0808

TAILGATE

Opening And Closing

! WARNING

AVOID INJURY OR DEATH

Never service or adjust the machine when the engine is running unless instructed to do so in the manual.

W-2012-0497

! WARNING

Keep the rear door closed when operating the machine. Failure to do so could seriously injure a bystander.

W-2020-1285

Figure 10-60-1

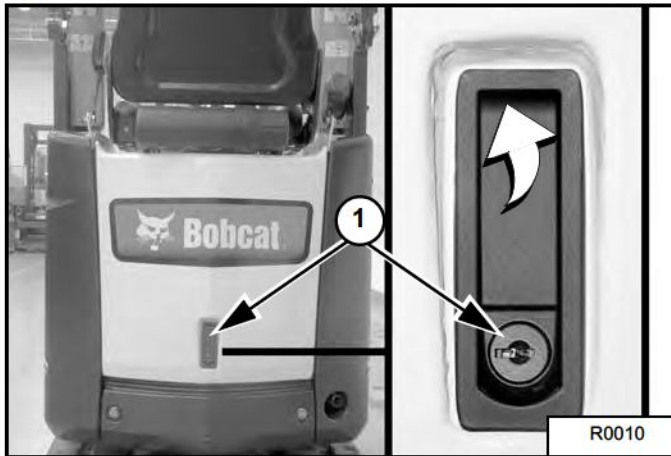

Release the latch (Item 1) [Figure 10-60-1] and pull the tailgate open.

Close the tailgate before operating the excavator.

Figure 10-60-2

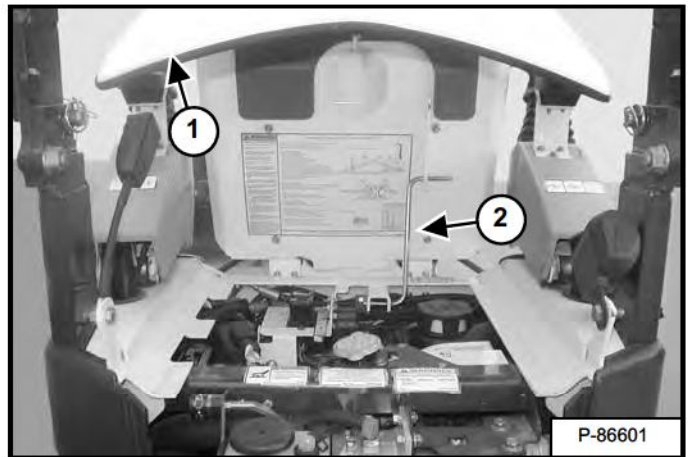

Raise the tailgate (Item 1) until the rod (Item 2) [Figure 10-60-2] is in the engaged position.

To close the tailgate, lift up slightly on the tailgate (Item 1) until the rod (Item 2) [Figure 10-60-2] can be moved to the disengaged position. Slowly lower the tailgate until it is completely lowered and in the latched position.

NOTE: The tailgate can be locked using the start key.

Dealer Copy -- Not for Resale

SERVICE SCHEDULE

Chart

Maintenance work must be done at regular intervals. Failure to do so will result in excessive wear and early failures. The service schedule is a guide for correct maintenance of the Bobcat Excavator.



AVOID INJURY OR DEATH

Instructions are necessary before operating or servicing machine. Read and understand the Operation & Maintenance Manual, Operator's Handbook and signs (decals) on machine. Follow warnings and instructions in the manuals when making repairs, adjustments or servicing. Check for correct function after adjustments, repairs or service. Untrained operators and failure to follow instructions can cause injury or death.

W-2003-0807

Every 10 Hours (Before Starting The Excavator)

- **Engine Oil** - Check level and add as needed. (See Checking And Adding Engine Oil on Page 10-110-1.)
- **Engine Air Filters and Air System** - Check condition indicator and empty dust cup as needed. Check air system for leaks. (See AIR CLEANER SERVICE on Page 10-80-1.)
- **Engine Cooling System** - Check coolant level COLD and add premixed coolant as needed. (See Checking Level on Page 10-90-1.)
- **Seat Belt, Seat Belt Retractors, Seat Belt Mounting hardware, Control Console Lockout** - Check the condition of seat belt and mounting hardware. Clean or replace seat belt retractors as needed. Check the control console lockout lever for proper operation. Clean dirt and debris from moving parts. (See Inspection And Maintenance on Page 10-170-1.) & (See Inspection And Maintenance on Page 10-180-1.)
- **Motion Alarm** - Check for proper function. (See Inspecting on Page 10-210-1.)
- **TOPS** - Check condition. Check mounting hardware. (See FOLD-DOWN TOPS on Page 10-50-1.)
- **Indicators and Lights** - Check for correct operation of all indicators and lights.
- **Safety Signs and Safety Tread** - Check for damaged signs (decals) and safety treads. Replace any signs or safety treads that are damaged.
- **Hydraulic Fluid, Hoses and Tubelines** - Check fluid level and add as needed. Check for damage and leaks. Repair or replace as needed. (See Checking And Adding Hydraulic Oil on Page 10-120-1.)
- **Track Tension** - Check tension and adjust as needed. (See Checking Tension on Page 30-20-2.)
- **Pivot Points** - Grease all machinery pivot points. (See Lubrication Locations on Page 10-130-1.)

Every 50 Hours

- **Swing Bearing** - Grease swing bearing and swing pinion. Service every 10 hours when operating in water. (See Lubrication Locations on Page 10-130-1.)
- **Battery** - Check cables, connections, and electrolyte level; add distilled water as needed. (See Servicing on Page 50-20-1.)
- **Fuel Tank** - Drain water and sediment from fuel tank and fuel filter. (See Fuel Filters on Page 10-100-2.)

Every 100 Hours

- **Spark Arrestor Muffler** - Clean spark chamber. (See Cleaning Procedure on Page 10-150-1.)
- **Drive Belts (Alternator / Fan)** - Check condition. Replace as needed. Service at first 50 hours, then as scheduled.
- **Alternator and Starter** - Service at first 50 hours, then as scheduled. Check connections.

Every 250 Hours Or Every 12 Months

- **Fuel Filter** - Replace filter. (See Fuel Filters on Page 10-100-2.)
- **Travel Motors (Final Drive)** - Check fluid level and add as needed. (See Checking And Adding Oil on Page 10-140-1.)

Dealer Copy -- Not for Resale

SERVICE SCHEDULE (CONT'D)

Maintenance Intervals (Cont'd)

Every 500 Hours Or Every 12 Months

- **Engine Oil and Filter** - Service at first 50 hours, then as scheduled. Replace oil and filter. (See Removing And Replacing Oil And Filter on Page 10-110-2.)
- **Cooling System** - Clean debris from radiator and hydraulic fluid cooler (if equipped). (See Cleaning on Page 10-90-1.)
- **Hydraulic Filter and Hydraulic Reservoir Breather Cap** - Replace the hydraulic filter and the reservoir breather cap. (See Removing And Replacing Hydraulic Filter on Page 10-120-2.)
- **Alternator and Starter** - Service at first 50 hours, then as scheduled. Check connections.
- **Engine Valves** - Adjust the engine valve clearance.

Every 1000 Hours Or Every 12 Months

- **Coolant** - Replace the coolant. (See Removing And Replacing The Coolant on Page 10-90-2.)
- **Hydraulic Fluid and Filters** - Replace hydraulic fluid and filters. Clean reservoir. (See Removing And Replacing Hydraulic Filter on Page 10-120-2.) & (See Removing And Replacing Hydraulic Fluid on Page 10-120-3.)
- **Travel Motors (Final Drive)** - Service at first 100 hours, then as scheduled. Replace fluid. (See Removing And Replacing Oil on Page 10-140-1.)

AIR CLEANER SERVICE

See the SERVICE SCHEDULE for the correct service interval (See SERVICE SCHEDULE on Page 10-70-1.).

Daily Check

Figure 10-80-1

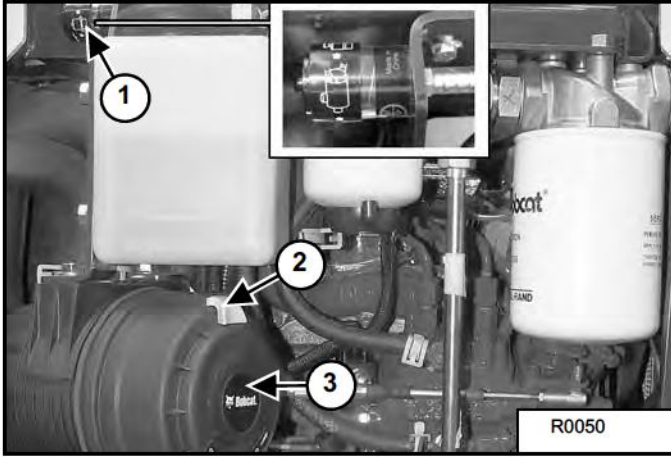

Check the condition indicator (Item 1) [Figure 10-80-1]. If the red ring shows in the condition indicator, the filter needs to be replaced.

Replacing The Filter Elements

Outer Filter

Pull out the locking tab (Item 2) [Figure 10-80-1].

Turn the dust cup (Item 3) [Figure 10-80-1] counter-clockwise about 1/8 turn.

Remove and clean the dust cup.

Figure 10-80-2

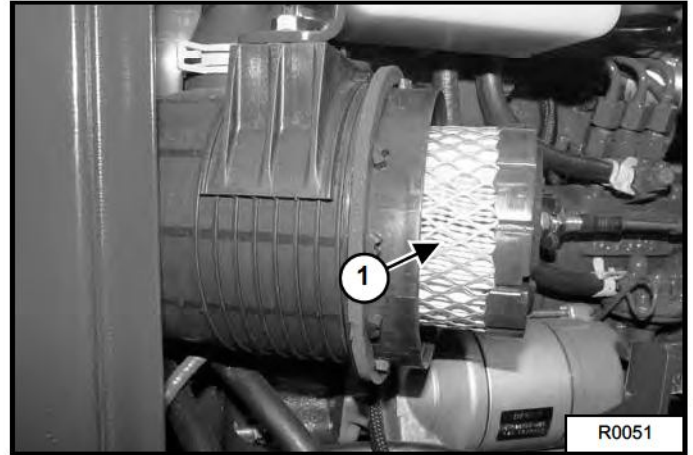

Pull the outer filter (Item 1) [Figure 10-80-2] from the air cleaner housing.

Check the housing for damage.

Clean the housing and the seal surface. DO NOT use compressed air.

Install a new outer filter.

Install the dust cup (Item 3) [Figure 10-80-1] and turn it clockwise about 1/8 turn.

Push the locking tab in (Item 2) [Figure 10-80-1].

Check the air intake hose and the air cleaner housing for damage. Make sure all connections are tight.

After the outer filter has been replaced, press the button (Item 1) [Figure 10-80-1] on the end of the condition indicator and start the engine.

Run at full rpm, then reduce engine speed and stop the engine. If the red ring shows in the condition indicator, replace the inner filter.

Dealer Copy -- Not for Resale

AIR CLEANER SERVICE (CONT'D)

Replacing the Filter Elements (Cont'd)

Inner Filter

Only replace the inner filter under the following conditions:

- Replace the inner filter every third time the outer filter is replaced.
- After the outer filter has been replaced, press the button on the top of the condition indicator (Item 1) [Figure 10-80-1] and start the engine. Run at full rpm, then reduce engine speed and stop the engine. If the red ring shows in the condition indicator, replace the inner filter.

Figure 10-80-3

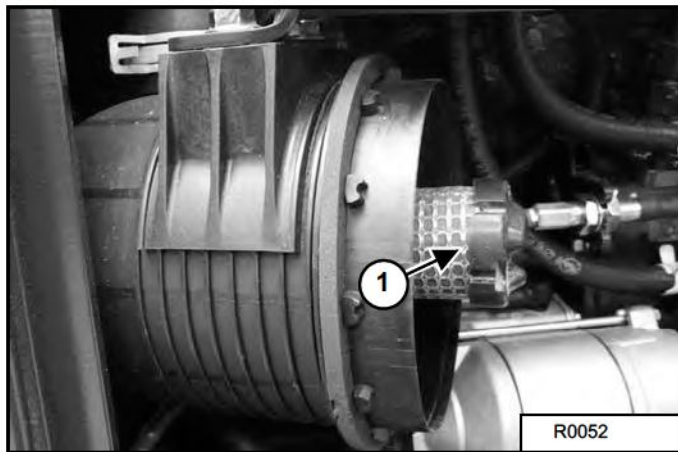

Remove the dust cup (Item 1) [Figure 10-80-1], the outer filter (Item 1) [Figure 10-80-2] and the inner filter (Item 1) [Figure 10-80-3].

NOTE: Make sure all sealing surfaces are free of dirt and debris.

Install the new inner filter.

Install the outer filter and the dust cup.

Press the button on the condition indicator to reset the condition indicator (Item 1) [Figure 10-80-1] (the red ring will not show anymore).

ENGINE COOLING SYSTEM

Check the cooling system every day to prevent overheating, loss of performance or engine damage.

Cleaning

Open the tailgate.

Use air pressure or water pressure to clean the radiator and oil cooler (if equipped).

Checking Level

WARNING

AVOID BURNS

Do not remove radiator cap when the engine is hot. You can be seriously burned.

W-2070-1203

WARNING

AVOID INJURY OR DEATH

Wear safety glasses to prevent eye injury when any of the following conditions exist:

- When fluids are under pressure.
- Flying debris or loose material is present.
- Engine is running.
- Tools are being used.

W-2019-0907

Figure 10-90-1

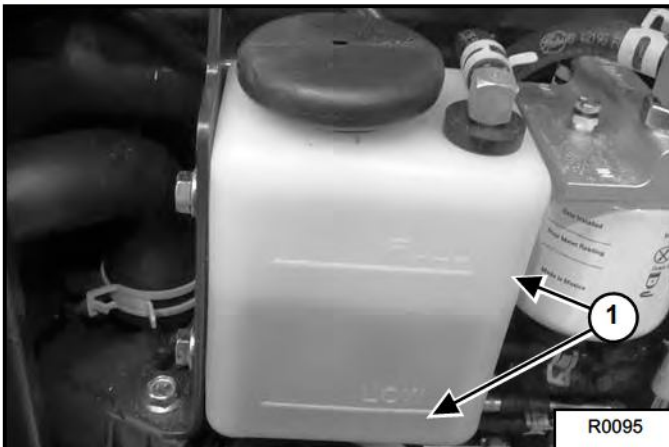

The coolant level must be between the marks (Item 1) [Figure 10-90-1] on the coolant recovery tank.

IMPORTANT

AVOID ENGINE DAMAGE

Always use the correct ratio of water to antifreeze.

Too much antifreeze reduces cooling system efficiency and may cause serious premature engine damage.

Too little antifreeze reduces the additives which protect the internal engine components; reduces the boiling point and freeze protection of the system.

Always add a premixed solution. Adding full strength concentrated coolant can cause serious premature engine damage.

I-2124-0497

ENGINE COOLING SYSTEM (CONT'D)

Removing And Replacing The Coolant

See THE SERVICE SCHEDULE for correct service intervals. (See SERVICE SCHEDULE on Page 10-70-1.)

WARNING

AVOID BURNS

Do not remove radiator cap when the engine is hot. You can be seriously burned.

W-2070-1203

Figure 10-90-2

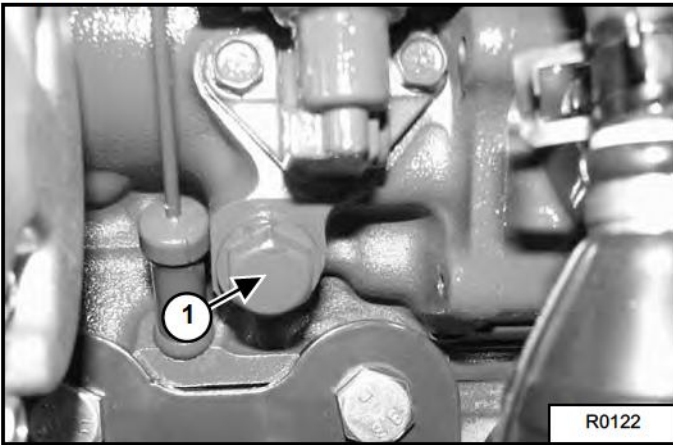

Remove the plug (Item 1) [Figure 10-90-2] on the engine block and drain the coolant into a container.

After all the coolant is removed, reinstall the plug.

NOTE: Fluids such as engine oil, hydraulic fluid, coolant, etc. must be disposed of in an environmentally safe manner. Some regulations require that certain spills and leaks on the ground must be cleaned in a specific manner. See local, state and federal regulations for correct disposal.

Recycle or dispose of the used coolant in an environmentally safe manner.

Mix the coolant in a separate container. (See Removing And Replacing The Coolant on Page 10-90-2.)

NOTE: The cooling system is factory filled with propylene glycol (purple color). DO NOT mix propylene glycol with ethylene glycol.

Figure 10-90-3

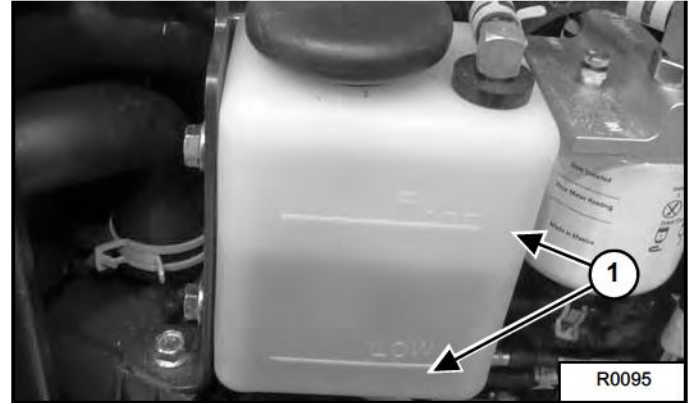

The coolant level must be between the marks (Item 1) [Figure 10-90-3] on the coolant recovery tank.

Add premixed coolant; 47% water and 53% propylene glycol to the recovery tank if the coolant level is low.

One gallon and one pint of propylene glycol mixed with one gallon of water is the correct mixture of coolant to provide a -34°F (-37°C) freeze protection.

Use a refractometer to check the condition of propylene glycol in your cooling system.

Add premixed coolant until the level is correct.

Run the engine until it is at operating temperature. Stop the engine. Check the coolant level and add as needed. Install the radiator cap and tighten.

Add coolant to the recovery tank as needed.

Close the tailgate.

IMPORTANT

AVOID ENGINE DAMAGE

Always use the correct ratio of water to antifreeze.

Too much antifreeze reduces cooling system efficiency and may cause serious premature engine damage.

Too little antifreeze reduces the additives which protect the internal engine components; reduces the boiling point and freeze protection of the system.

Always add a premixed solution. Adding full strength concentrated coolant can cause serious premature engine damage.

I-2124-0497

FUEL SYSTEM

Fuel Specifications

Use only clean, high quality diesel fuel, Grade No. 2 or Grade No. 1.

The following is a suggested blending guideline which should prevent fuel gelling problems during freezing temperature

Temp. C° (F°)	No. 2	No. 1
Above -9° (+15°)	100%	0%
Down to -29° (-20°)	50%	50%
Below -29° (-20°)	0%	100%

At a minimum, low sulfur diesel fuel must be used in this machine. Low sulfur is defined as 500 mg/kg (500 ppm) sulfur maximum.

The following fuels may also be used in this machine:

- Ultra low sulfur diesel fuel. Ultra low sulfur is defined as 15 mg/kg (15 ppm) sulfur maximum.
- Biodiesel blend fuel - Must contain no more than five percent biodiesel mixed with low sulfur or ultra low sulfur petroleum based diesel. This is commonly marketed as B5 blended diesel fuel. B5 blended diesel fuel must meet ASTM D975 (US Standard) or EN590 (EU Standard) specifications.

Biodiesel Blend Fuel

Biodiesel blend fuel has unique qualities that should be considered before using in this machine:

- Cold weather conditions can lead to plugged fuel system components and hard starting.
- Biodiesel blend fuel is an excellent medium for microbial growth and contamination which can cause corrosion and plugging of fuel system components.
- Use of biodiesel blend fuel may result in premature failure of fuel system components, such as plugged fuel filters and deteriorated fuel lines.
- Shorter maintenance intervals may be required, such as cleaning the fuel system and replacing fuel filters and fuel lines.
- Using biodiesel blended fuels containing more than five percent biodiesel can affect engine life and cause deterioration of hoses, tubelines, injectors, injector pump and seals.

Apply the following guidelines if biodiesel blend fuel is used:

- Ensure the fuel tank is as full as possible at all times to prevent moisture from collecting in the fuel tank.
- Ensure that the fuel tank cap is securely tightened.
- Biodiesel blend fuel can damage painted surfaces, remove all spilled fuel from painted surfaces immediately.
- Drain all water from the fuel filter daily before operating the machine.
- Do not exceed engine oil change interval. Extended oil change intervals can cause engine damage.
- Before vehicle storage; drain the fuel tank, refill with 100% petroleum diesel fuel, add fuel stabilizer and run the engine for at least 30 minutes.

NOTE: Biodiesel blend fuel does not have long term stability and should not be stored for more than three months.

Dealer Copy -- Not for Resale

FUEL SYSTEM (CONT'D)

Filling The Fuel Tank

Figure 10-100-1

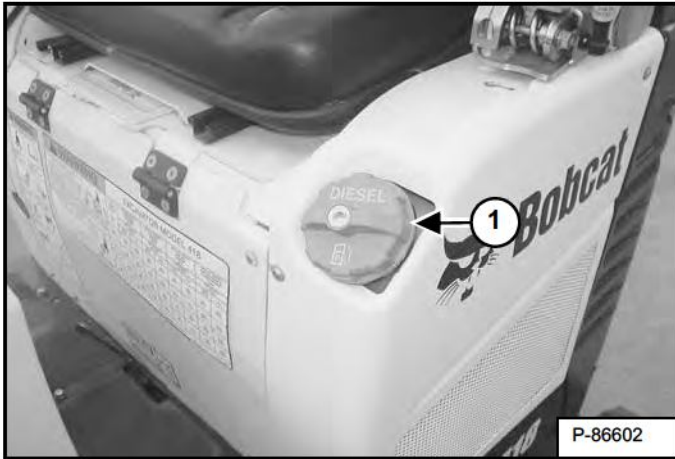

Remove the fuel fill cap (Item 1) using the key [Figure 10-100-1].

Use a clean, approved safety container to add fuel. Add fuel only in an area that has a free movement of air and no flames or sparks. **NO SMOKING!**

Install and tighten the fuel fill cap.

See the SERVICE SCHEDULE for the service interval when to remove water from or replace the fuel filter. (See SERVICE SCHEDULE on Page 10-70-1.).

WARNING

AVOID INJURY OR DEATH

Always clean up spilled fuel or oil. Keep heat, flames, sparks or lighted tobacco away from fuel and oil. Failure to use care around combustibles can cause explosion or fire.

W-2103-0508

Fuel Filters

Removing Water

Open the tailgate.

Figure 10-100-2

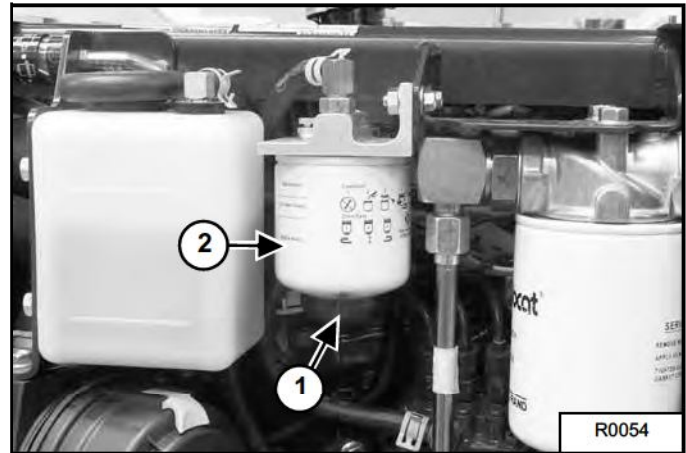

Loosen the drain (Item 1) [Figure 10-100-2] at the bottom of the filter to drain water from the filter.

Replacing Elements

Remove the filter (Item 2) [Figure 10-100-2].

Clean the area around the filter housing. Put clean oil on the seal of the new filter. Install the fuel filter and tighten by hand.

Remove the air from the fuel system. (See Removing Air From The Fuel System on Page 10-100-3.).

Draining The Fuel Tank

Remove the fuel line at the engine and put the end of the hose in a fuel can, and drain the fuel tank that way (siphon action).

See the SERVICE SCHEDULE for the correct service interval. (See SERVICE SCHEDULE on Page 10-70-1.).

FUEL SYSTEM (CONT'D)

Removing Air From The Fuel System

After replacing the fuel filter or when the fuel tank has run out of fuel, air must be removed from the fuel system before starting the engine.

Figure 10-100-3

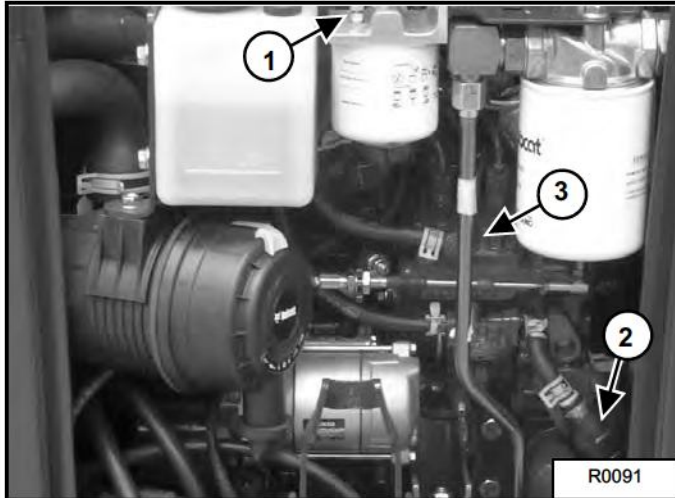

Open the fuel filter vent (Item 1) [Figure 10-100-3].

Operate the hand pump (priming bulb) (Item 2) [Figure 10-100-3] until the fuel flows from the vent with no air bubbles.

Close the vent (Item 1) [Figure 10-100-3] on the fuel filter housing.

Start the engine and let it run at low idle. It may be necessary to open the vent at the fuel injection pump (Item 3) [Figure 10-100-3] briefly until the engine runs smoothly.

WARNING

AVOID INJURY OR DEATH

Diesel fuel or hydraulic fluid under pressure can penetrate skin or eyes, causing serious injury or death. Fluid leaks under pressure may not be visible. Use a piece of cardboard or wood to find leaks. Do not use your bare hand. Wear safety goggles. If fluid enters skin or eyes, get immediate medical attention from a physician familiar with this injury.

W-2072-0807



Suggest:

If the above button click is invalid.

Please download this document

first, and then click the above link

to download the complete manual.

Thank you so much for reading

ENGINE LUBRICATION SYSTEM

Checking And Adding Engine Oil

Check the engine oil every day before starting the engine for the work shift.

Figure 10-110-1

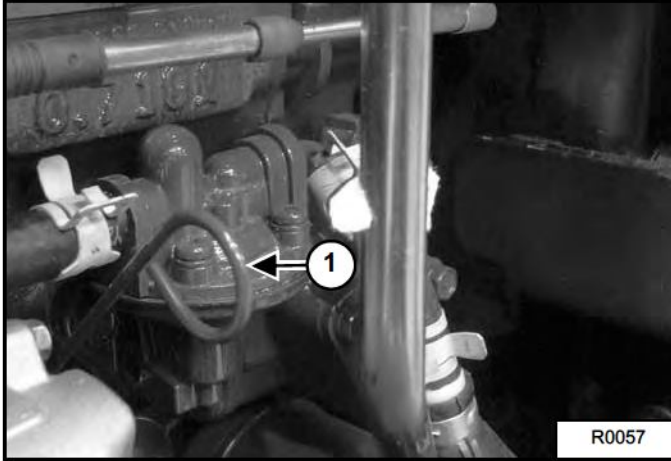

Open the tailgate and remove the dipstick (Item 1) [Figure 10-110-1].

Keep the oil level between the marks on the dipstick.

Engine Oil Chart

Figure 10-110-2

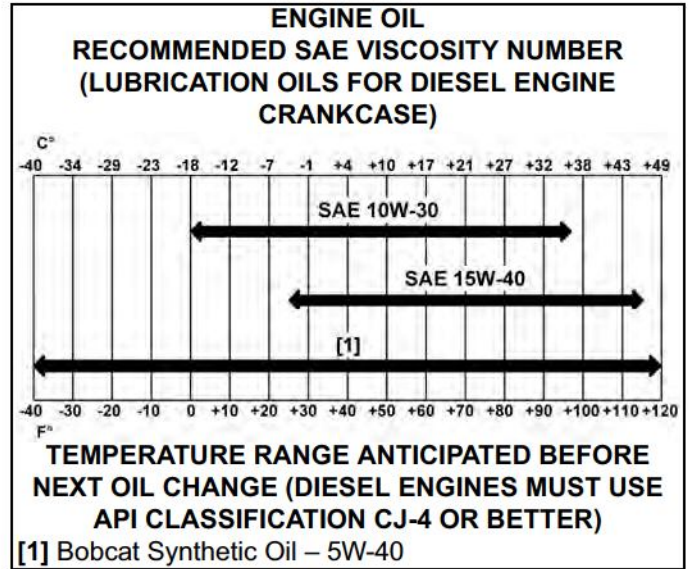

Bobcat engine oils are recommended for use in this machine. If Bobcat engine oil is not available, use a good quality engine oil that meets API Service Classification of CJ-4 or better [Figure 10-110-2].

Dealer Copy -- Not for Resale

<https://www.ebooklibonline.com>

Hello dear friend!

Thank you very much for reading.

Enter the link into your browser.

The full manual is available for immediate download.

<https://www.ebooklibonline.com>