



Bobcat®

Service Manual

335 Compact Excavator

S/N AAD111001 & Above
S/N A9KA11001 & Above

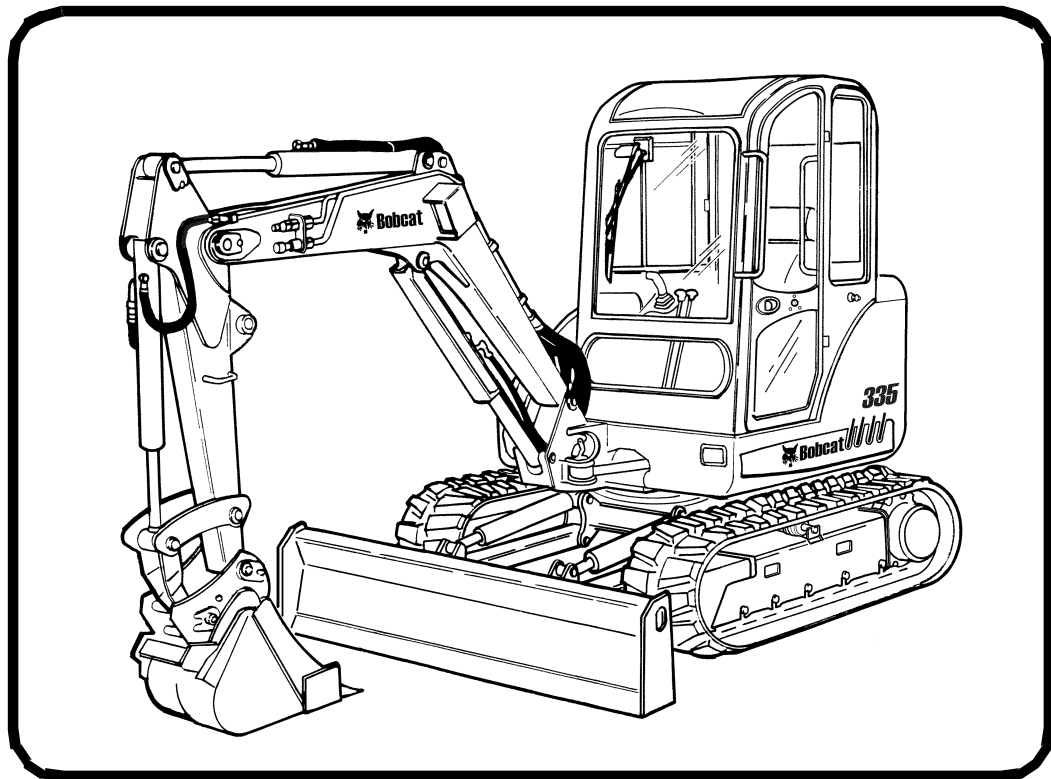

MAINTENANCE SAFETY



WARNING

Instructions are necessary before operating or servicing machine. Read and understand the Operation & Maintenance Manual, Operator's Handbook and signs (decals) on machine. Follow warnings and instructions in the manuals when making repairs, adjustments or servicing. Check for correct function after adjustments, repairs or service. Untrained operators and failure to follow instructions can cause injury or death.

W-2003-0903



Safety Alert Symbol: This symbol with a warning statement, means: "Warning, be alert! Your safety is involved!" Carefully read the message that follows.

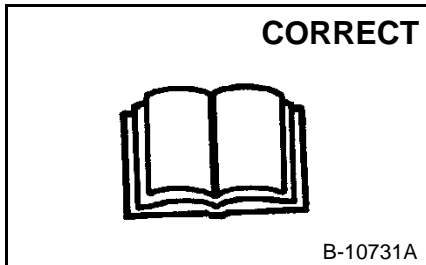

B-10731A

- ⚠ Never service the Bobcat Compact Excavator without instructions.

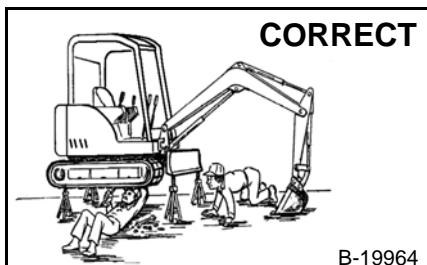

B-19964

- ⚠ Use the correct procedure to lift and support the excavator.

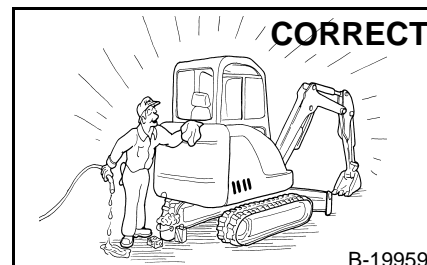

B-19959

- ⚠ Cleaning and maintenance are required daily.

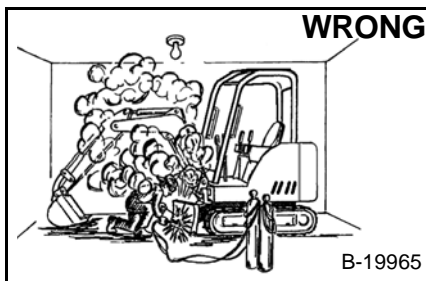

B-19965

- ⚠ Have good ventilation when welding or grinding painted parts.
- ⚠ Wear dust mask when grinding painted parts. Toxic dust and gas can be produced.

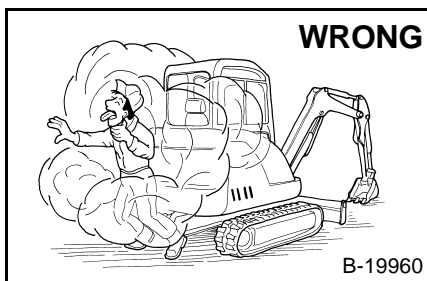

B-19960

- ⚠ Vent exhaust to outside when engine must be run for service.
- ⚠ Exhaust system must be tightly sealed. Exhaust fumes can kill without warning.

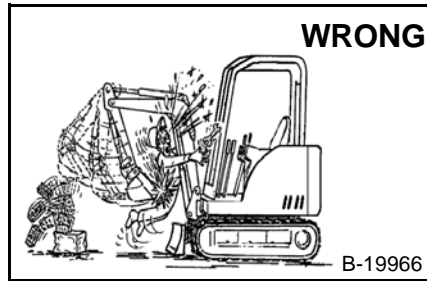

B-19966

- ⚠ Always lower the bucket and blade to the ground before doing any maintenance.
- ⚠ Never modify equipment or add attachments not approved by Bobcat Company.

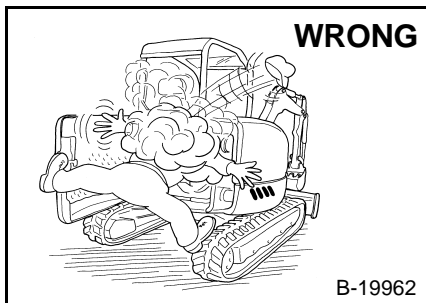

B-19962

- ⚠ Stop, cool and clean engine of flammable materials before checking fluids.
- ⚠ Never service or adjust machine with the engine running unless instructed to do so in the manual.
- ⚠ Avoid contact with leaking hydraulic fluid or diesel fuel under pressure. It can penetrate the skin or eyes.
- ⚠ Never fill fuel tank with engine running, while smoking, or when near open flame.

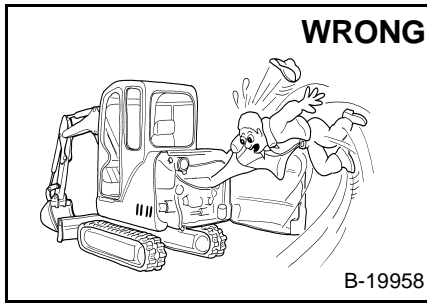

B-19958

- ⚠ Keep body, jewelry and clothing away from moving parts, electrical contact, hot parts and exhaust.
- ⚠ Wear eye protection to guard from battery acid, compressed springs, fluids under pressure and flying debris when engines are running or tools are used. Use eye protections approved for type of welding.
- ⚠ Keep tailgate closed except for service. Close and latch tailgate before operating the excavator.

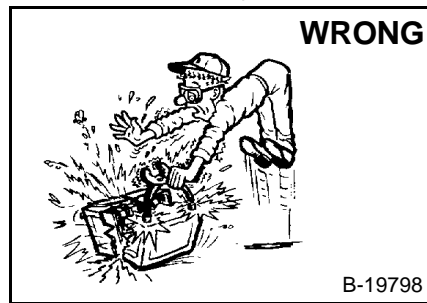

B-19798

- ⚠ Lead-acid batteries produce flammable and explosive gases.
- ⚠ Keep arcs, sparks, flames and lighted tobacco away from batteries.
- ⚠ Batteries contain acid which burns eyes or skin on contact.
- ⚠ Wear protective clothing. If acid contacts body, flush well with water. For eye contact flush well and get immediate medical attention.

Maintenance procedures which are given in the Operation & Maintenance Manual can be performed by the owner/operator without any specific technical training. Maintenance procedures which are **not** in the Operation & Maintenance Manual must be performed **ONLY BY QUALIFIED BOBCAT SERVICE PERSONNEL**. Always use genuine Bobcat replacement parts. The Service Safety Training Course is available from your Bobcat dealer.

MSW28-0805

ALPHABETICAL INDEX

| | | | |
|--------------------------------------|--------------|---|--------------|
| ACCESSORY DRIVE BELT | 10-01 | EXCAVATOR STORAGE AND RETURN TO SERVICE | 10-01 |
| AIR CLEANER | 60-01 | EXPANSION VALVE | 70-01 |
| AIR CLEANER SERVICE | 10-01 | FAN | 60-01 |
| AIR CONDITIONING SYSTEM FLOW | 70-01 | FLOORMAT AND FLOOR PANEL | 40-01 |
| ALTERNATOR | 50-01 | FUEL LEVEL SENDER | 50-01 |
| ANGLE BLADE | 30-01 | FUEL SYSTEM..... | 10-01, 60-01 |
| ANGLE BLADE ASSEMBLY | 30-01 | FUEL TANK | 40-01 |
| ANGLE BLADE CUTTING EDGE | 30-01 | FLYWHEEL AND HOUSING | 60-01 |
| ANGLE BLADE CYLINDER | 20-01 | | |
| ANGLE BLADE VALVE | 20-01 | HEATER COIL | 70-01 |
| ARM | 40-01 | HEATER VALVE | 70-01 |
| ARM CYLINDER | 20-01 | HORN | 40-01 |
| | | HYDRAULIC CONTROL VALVE | 20-01 |
| BATTERY | 50-01 | HYDRAULIC CONNECTION SPECIFICATIONS | SPEC-01 |
| BLADE | 30-01 | HYDRAULIC FLUID SPECIFICATIONS..... | SPEC-01 |
| BLADE CONTROL | 40-01 | HYDRAULIC FILTER | 20-01 |
| BLADE CYLINDER | 20-01 | HYDRAULIC PUMP | 20-01 |
| BLOWER FAN | 70-01 | HYDRAULIC PUMP START-UP | 20-01 |
| BOOM | 40-01 | HYDRAULIC RESERVOIR..... | 20-01 |
| BOOM CYLINDER | 20-01 | HYDRAULIC SYSTEM | 10-01 |
| BOOM SWING CYLINDER..... | 20-01 | HYDRAULIC SYSTEM INFORMATION | 20-01 |
| BOOM SWING LOCK VALVE | 20-01 | HYDRAULIC X-CHANGE VALVE | 20-01 |
| BOOM SWING PEDAL | 20-01 | | |
| BUCKET | 40-01 | LEFT CONTROL LEVER (JOYSTICK) | 20-01 |
| BUCKET CYLINDER | 20-01 | LEFT CONSOLE | 40-01 |
| | | LIFTING AND BLOCKING THE EXCAVATOR | 10-01 |
| CAB..... | 40-01 | LIFTING THE EXCAVATOR | 10-01 |
| CAMSHAFT AND TIMING GEARS..... | 60-01 | LIGHTS..... | 50-01 |
| CANOPY | 40-01 | LUBRICATING THE EXCAVATOR | 10-01 |
| CASE DRAIN FILTER | 20-01 | LUBRICATION SYSTEM | 60-01 |
| COMPRESSOR | 70-01 | | |
| CONDENSOR | 70-01 | MAGNETIC LOCKOUT SENSOR | 50-01 |
| CONVERSIONS | SPEC-01 | MAIN RELIEF VALVE | 20-01 |
| CONTROL PATTERN SELECTOR VALVE | 20-01 | MANIFOLD ASSEMBLY/ACCUMULATOR | 20-01 |
| CRANKSHAFT AND PISTONS | 60-01 | | |
| CROSS PORT RELIEF VALVES | 20-01 | OIL COOLER..... | 20-01 |
| CYLINDER HEAD..... | 60-01 | OPERATOR CAB (ROPS/TOPS) | 10-01 |
| | | | |
| DIAGNOSTICS SERVICE CODES..... | 50-01 | PIVOT PINS | 10-01 |
| DIRECT TO TANK VALVE | 20-01 | PORT RELIEF VALVES..... | 20-01 |
| | | PRESSURE REDUCING VALVE..... | 20-01 |
| ELECTRICAL SYSTEM INFORMATION | 50-01 | | |
| ENGINE COOLING SYSTEM..... | 10-01, 60-01 | RECEIVER/DRIER | 70-01 |
| ENGINE INFORMATION | 60-01 | REGULAR MAINTENANCE | 70-01 |
| ENGINE LUBRICATION SYSTEM..... | 10-01 | RIGHT CONTROL LEVER (JOYSTICK) | 20-01 |
| ENGINE SPEED CONTROL | 60-01 | RIGHT CONSOLE | 40-01 |
| EVAPORATOR COIL | 70-01 | RIGHT SIDE COVER | 10-01, 40-01 |
| EVAPORATOR/HEATER UNIT | 70-01 | | |
| EVAPORATOR SPECIFICATIONS | SPEC-01 | | |

Continued On Next Page

<https://www.ebooklibonline.com>

Hello dear friend!

Thank you very much for reading.

Enter the link into your browser.

The full manual is available for immediate download.

<https://www.ebooklibonline.com>

ALPHABETICAL INDEX (CONT'D)

| | |
|--|--------------|
| SAFETY | 70-01 |
| SEAT AND SEAT MOUNT | 40-01 |
| SEAT BELT | 10-01 |
| SERVICE SCHEDULE | 10-01 |
| SPARK ARRESTOR MUFFLER | 10-01, 60-01 |
| STARTER | 50-01 |
| STOPPING THE ENGINE AND LEAVING THE EXCAVATOR | 10-01 |
| SWING CIRCLE GEAR | 30-01 |
| SWING FRAME | 40-01 |
| SWING MOTOR | 20-01 |
| SWING MOTOR DRIVE CARRIER..... | 20-01 |
| SWIVEL JOINT | 20-01 |
| SYSTEM CHARGING AND RECLAMATION..... | 70-01 |
| | |
| TAILGATE | 10-01, 40-01 |
| THERMOSTAT | 70-01 |
| TORQUE SPECIFICATIONS FOR BOLTS..... | SPEC-01 |
| TRACK FRAME COMPONENTS | 30-01 |
| TRANSPORTING THE EXCAVATOR ON A TRAILER..... | 10-01 |
| TRAVEL CONTROL VALVE | 20-01 |
| TRAVEL LEVER/PEDALS | 40-01 |
| TRAVEL MOTOR..... | 10-01, 20-01 |
| TROUBLESHOOTING..... | 70-01 |
| | |
| UPPERSTRUCTURE | 40-01 |
| UPPERSTRUCTURE SLEW LOCK | 10-01, 40-01 |
| | |
| X-CHANGE | 40-01 |
| X-CHANGE (HYDRAULIC)..... | 40-01 |

CONTENTS

| | |
|--|---------|
| FOREWORD..... | III |
| SAFETY INSTRUCTIONS | V |
| SERIAL NUMBER LOCATIONS | IX |
| DELIVERY REPORT..... | X |
| EXCAVATOR IDENTIFICATION | XI |
| SAFETY AND MAINTENANCE..... | 10-01 |
| HYDRAULIC SYSTEM | 20-01 |
| UNDERCARRIAGE..... | 30-01 |
| UPPERSTRUCTURE & SWING SECTION | 40-01 |
| ELECTRICAL SYSTEM AND ANALYSIS | 50-01 |
| ENGINE SERVICE | 60-01 |
| HEATING, VENTILATION, AIR CONDITIONING | 70-01 |
| SPECIFICATIONS..... | SPEC-01 |

**SAFETY AND
MAINTENANCE**

**HYDRAULIC
SYSTEM**

UNDERCARRIAGE

**UPPERSTRUCTURE
& SWING
SECTION**

**ELECTRICAL
SYSTEM AND
ANALYSIS**

**ENGINE
SERVICE**

HVAC

SPECIFICATIONS

FOREWORD

This manual is for the Bobcat Hydraulic Excavator mechanic. It provides necessary servicing and adjustment procedures for the hydraulic excavator and its component parts and systems. Refer to the Operation & Maintenance Manual for operating instructions, starting procedure, daily checks, etc.

A general inspection of the following items must be made after the hydraulic excavator has had service or repair:

1. Check that the ROPS/TOPS/FOPS is in good condition and is not modified.

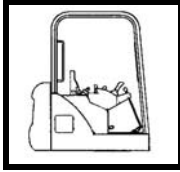

2. Check that ROPS/TOPS mounting hardware is tightened and is Bobcat approved.

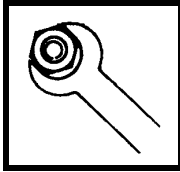

3. The seat belt must be correctly installed, functional and in good condition.

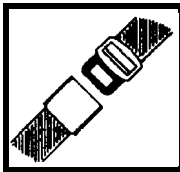

4. Inspect for loose or broken parts or connections.

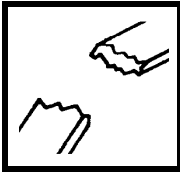

5. Machine signs must be legible and in the correct location.



6. Steering levers, control levers and foot pedals must return to neutral. Check that foot pedals lock and control lever locks are in working order.

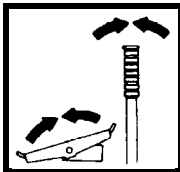

7. Inspect the air cleaner for damage or leaks. Check the condition of the element.

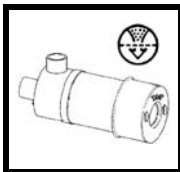

8. Check the electrical charging system.

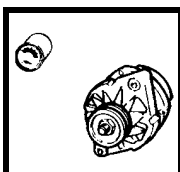

9. Safety treads must be in good condition.

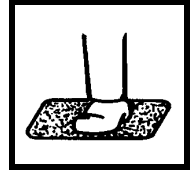

10. Check for correct function of indicator lamps (Optional on some models).

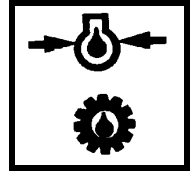

11. Check hydraulic fluid level, engine oil level and fuel supply.

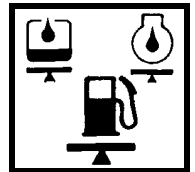

12. Inspect for fuel, oil or hydraulic fluid leaks.

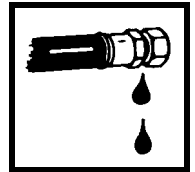

13. Lubricate the excavator.

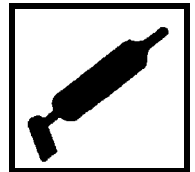

14. Check the condition of the battery and cables.

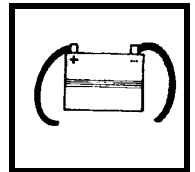

Recommend to the owner that all necessary corrections be made before the machine is returned to service.

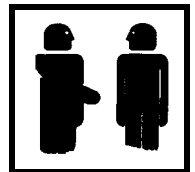

SAFETY INSTRUCTIONS (CONT'D)

Safe Operation Is The Operator's Responsibility



Operator must have instructions before running the machine. Untrained operators can cause injury or death.

W-2001-1285



This notice identifies procedures which must be followed to avoid damage to the machine.

I-2019-0284



Warnings on the machine and in the manuals are for your safety. Failure to obey warnings can cause injury or death.

W-2044-1285

The Bobcat excavator and attachment must be in good operating condition before use.

Check all of the items on the Bobcat Service Schedule Decal under the 8-10 hour column or as shown in the Operation & Maintenance Manual.

Safe Operation Needs A Qualified Operator

For an operator to be qualified, he or she must not use drugs or alcoholic drinks which impair alertness or coordination while working. An operator who is taking prescription drugs must get medical advice to determine if he or she can safely operate a machine.

A Qualified Operator Must Do The Following:

Understand the Written Instructions, Rules and Regulations

- The written instructions from Bobcat Company include the Delivery Report, Operation & Maintenance Manual, Operator's Handbook, Safety Manual and machine signs (decals).
- Check the rules and regulations at your location. The rules may include an employer's work safety requirements. Regulations may apply to local driving requirements or use of a Slow Moving Vehicle (SMV) emblem. Regulations may identify a hazard such as a utility line.

Have Training with Actual Operation

- Operator training must consist of a demonstration and verbal instruction. This training is given by your Bobcat dealer before the product is delivered.
- The new operator must start in an area without bystanders and use all the controls until he or she can operate the machine and attachment safely under all conditions of the work area. Always fasten seat belt before operating.
- Operator Training Courses are available from your Bobcat dealer in English and Spanish. They provide information for safe and efficient equipment operation. Safety videos are also available.
- Service Safety Training Courses are available from your Bobcat dealer. They provide information for safe and correct service procedures.

Know the Work Conditions

- Know the weight of the materials being handled. Avoid exceeding the Rated Lift Capacity of the machine. Material which is very dense will be heavier than the same volume of less dense material. Reduce the size of load if handling dense material.
- The operator must know any prohibited uses or work areas, for example, he or she needs to know about excessive slopes.
- Know the location of any underground lines. Call local utilities or the TOLL FREE phone number found in the *Before Operation* Section of this manual.
- Wear tight fitting clothing. Always wear safety glasses when doing maintenance or service. Safety glasses, respiratory equipment, hearing protection or Special Applications Kits are required for some work. See your Bobcat dealer about Bobcat Safety Equipment for your model.

SI EXC-1007

FIRE PREVENTION



Maintenance

The machine and some attachments have components that are at high temperatures under normal operating conditions. The primary source of high temperatures is the engine and exhaust system. The electrical system, if damaged or incorrectly maintained, can be a source of arcs or sparks.

Flammable debris (leaves, straw, etc.) must be removed regularly. If flammable debris is allowed to accumulate, it can cause a fire hazard. Clean often to avoid this accumulation. Flammable debris in the engine compartment is a potential fire hazard.

The operator's area, engine compartment and engine cooling system must be inspected every day and cleaned if necessary to prevent fire hazards and overheating.

All fuels, most lubricants and some coolants mixtures are flammable. Flammable fluids that are leaking or spilled onto hot surfaces or onto electrical components can cause a fire.

Operation

Do not use the machine where exhaust, arcs, sparks or hot components can contact flammable material, explosive dust or gases.

Electrical



Check all electrical wiring and connections for damage. Keep the battery terminals clean and tight. Repair or replace any damaged part or wires that are loose or frayed.

Battery gas can explode and cause serious injury. Use the procedure in the Operation & Maintenance Manual for connecting the battery and for jump starting. Do not jump start or charge a frozen or damaged battery. Keep any open flames or sparks away from batteries. Do not smoke in battery charging area.

Hydraulic System

Check hydraulic tubes, hoses and fittings for damage and leakage. Never use open flame or bare skin to check for leaks. Hydraulic tubes and hoses must be properly routed and have adequate support and secure clamps. Tighten or replace any parts that show leakage.

Always clean fluid spills. Do not use gasoline or diesel fuel for cleaning parts. Use commercial nonflammable solvents.

Fueling



Stop the engine and let it cool before adding fuel. No smoking! Do not refuel a machine near open flames or sparks. Fill the fuel tank outdoors.

Starting

Do not use ether or starting fluids on any engine that has glow plugs. These starting aids can cause explosion and injure you or bystanders.

Use the procedure in the Operation & Maintenance Manual for connecting the battery and for jump starting.

Spark Arrestor Exhaust System

The spark arrestor exhaust system is designed to control the emission of hot particles from the engine and exhaust system, but the muffler and the exhaust gases are still hot.

Check the spark arrestor exhaust system regularly to make sure it is maintained and working properly. Use the procedure in the Operation & Maintenance Manual for cleaning the spark arrestor muffler (if equipped).

FIRE PREVENTION (CONT'D)

Welding And Grinding

Always clean the machine and attachment, disconnect the battery, and disconnect the wiring from the Bobcat controllers before welding. Cover rubber hoses, battery and all other flammable parts. Keep a fire extinguisher near the machine when welding.

Have good ventilation when grinding or welding painted parts. Wear dust mask when grinding painted parts. Toxic dust or gas can be produced.

Dust generated from repairing nonmetallic parts such as hoods, fenders or covers can be flammable or explosive. Repair such components in a well ventilated area away from open flames or sparks.

Fire Extinguishers

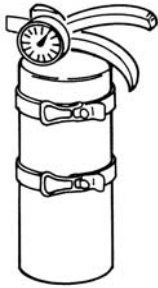

Know where fire extinguishers and first aid kits are located and how to use them. Inspect the fire extinguisher and service the fire extinguisher regularly. Obey the recommendations on the instructions plate.

SERIAL NUMBER LOCATIONS

Always use the serial number of the excavator when requesting service information or when ordering parts. Early or later models (identification made by serial number) may use different parts, or it may be necessary to use a different procedure in doing a specific service operation.

Excavator Serial Number

Figure 1

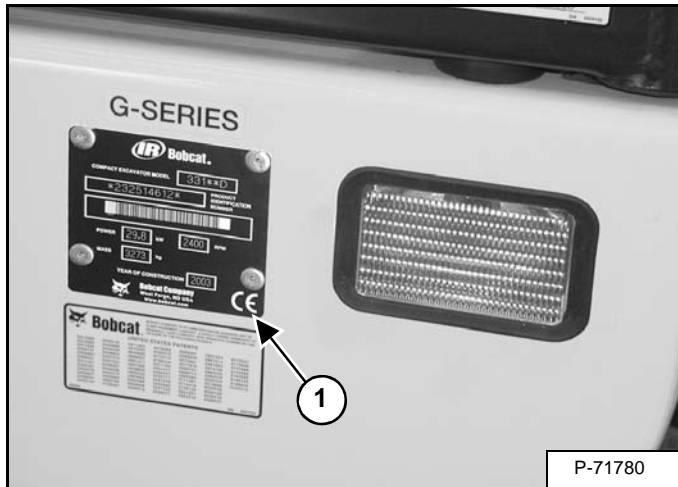

The excavator serial number plate (Item 1) is located on the frame of the machine in the location shown [Figure 1].

Explanation of excavator Serial Number:

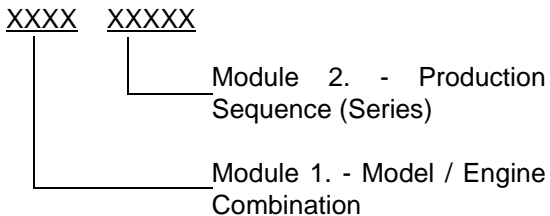

1. The four digit Model/Engine Combination Module number identifies the model number and engine combination.

2. The five digit Production Sequence Number identifies the order which the excavator is produced.

Engine Serial Number

Figure 2

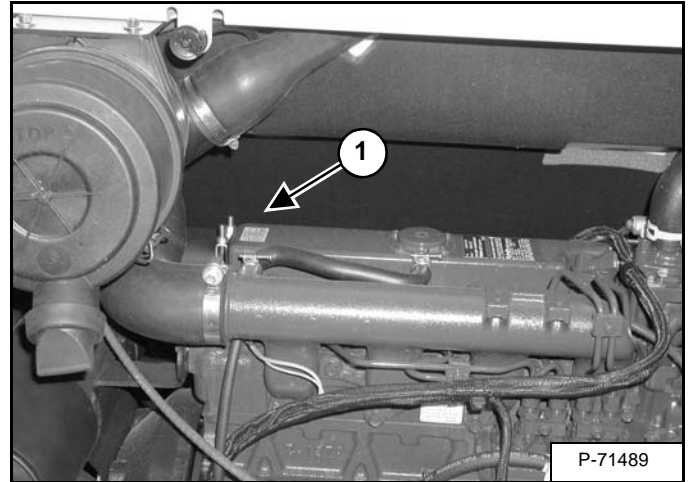
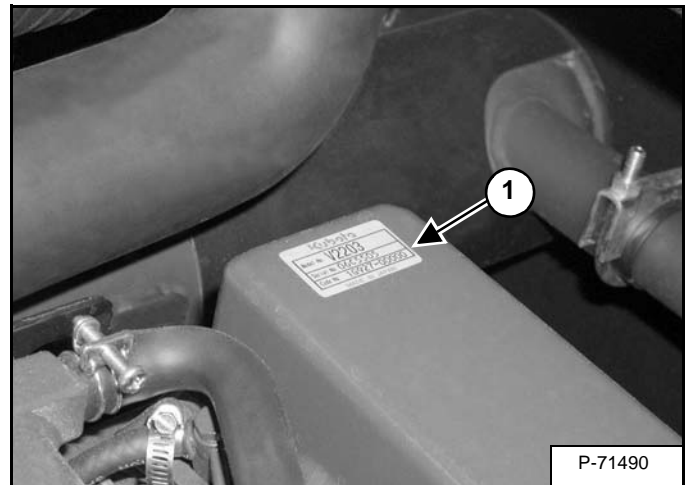

Figure 3



The engine serial number (Item 1) [Figure 2] & [Figure 3] is located on the engine in the locations shown.

DELIVERY REPORT

Figure 4

The diagram shows a form layout for a delivery report. It features a main title 'DELIVERY REPORT' at the top. Below the title, there are two columns of horizontal lines representing text input fields. On the left side, there is a section with a dark header containing the word 'WARNING' in white capital letters, followed by several lines of text. At the bottom right of the form, there is a small rectangular box containing the alphanumeric code 'B-16315'.

The delivery report must be filled out by the dealer and signed by the owner or operator when the Bobcat Excavator is delivered. An explanation of the form must be given to the owner. Make sure it is filled out completely **[Figure 4]**.

EXCAVATOR IDENTIFICATION

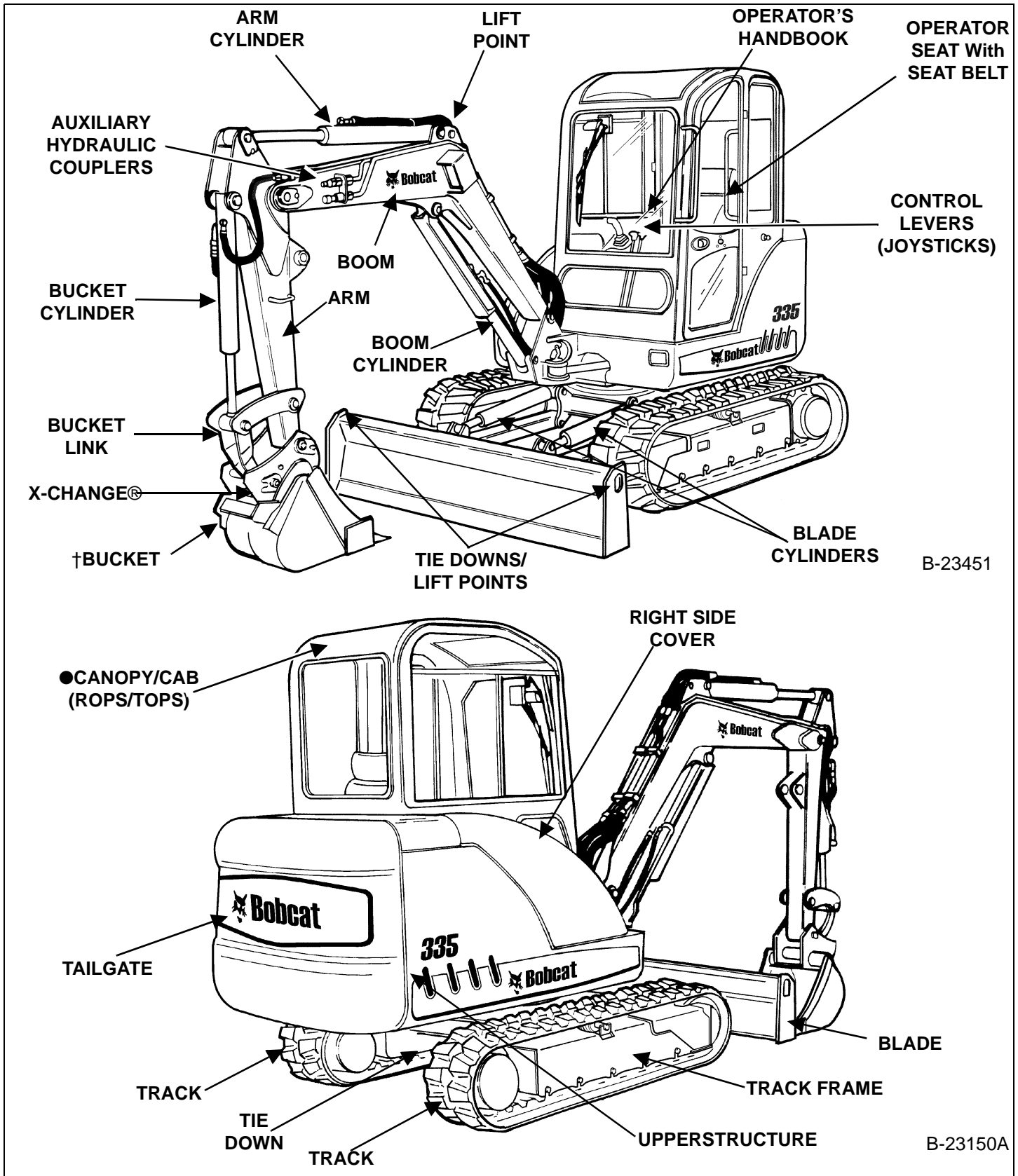

- † BUCKET - Several different buckets and other attachments are available from the Bobcat Excavator.
- ROPS, TOPS - (Roll Over Protective Structure / Tip Over Protective Structure) as standard equipment. The ROPS/TOPS meets SAE J1040, ISO 3471 and ISO 12117.

| | |
|--|----------|
| ACCESSORY DRIVE BELT | 10-140-1 |
| Belt Adjustment | 10-140-1 |
| Belt Replacement. | 10-140-1 |
| AIR CLEANER SERVICE | 10-60-1 |
| Daily Check | 10-60-1 |
| Replacing Filter Elements | 10-60-1 |
| ENGINE COOLING SYSTEM | 10-70-1 |
| Checking Level | 10-70-1 |
| Cleaning. | 10-70-1 |
| Removing And Replacing Coolant. | 10-70-2 |
| ENGINE LUBRICATION SYSTEM | 10-90-1 |
| Checking And Adding Engine Oil. | 10-90-1 |
| Engine Oil Chart. | 10-90-1 |
| Removing And Replacing Oil And Filter. | 10-90-2 |
| EXCAVATOR STORAGE AND RETURN TO SERVICE | 10-170-1 |
| Return To Service | 10-170-1 |
| Storage | 10-170-1 |
| FUEL SYSTEM | 10-80-1 |
| Biodiesel Blend Fuel | 10-80-1 |
| Draining The Fuel Tank | 10-80-3 |
| Fuel Filter. | 10-80-3 |
| Fuel Specifications. | 10-80-1 |
| Removing Air From The Fuel System | 10-80-4 |
| HYDRAULIC SYSTEM | 10-100-1 |
| Checking And Adding Fluid | 10-100-1 |
| Removing And Replacing Hydraulic Case Drain Filter . . | 10-100-2 |
| Removing And Replacing Hydraulic Filter | 10-100-2 |
| Removing And Replacing Hydraulic Fluid | 10-100-3 |
| LIFTING AND BLOCKING THE EXCAVATOR | 10-10-1 |
| Procedure | 10-10-1 |
| LIFTING THE EXCAVATOR | 10-12-1 |
| Procedure | 10-12-1 |

Continued On Next Page

SAFETY AND MAINTENANCE (CONT'D)

| | |
|---|----------|
| LUBRICATING THE EXCAVATOR | 10-110-1 |
| Lubrication Locations | 10-110-1 |
| MOTION ALARM SYSTEM (IF EQUIPPED)..... | 10-190-1 |
| Adjusting Switch Position..... | 10-190-1 |
| Description | 10-190-1 |
| Inspecting | 10-190-1 |
| OPERATOR CAB (ROPS / TOPS) | 10-20-1 |
| Cab Door | 10-20-1 |
| Description | 10-20-1 |
| Front Wiper | 10-20-4 |
| Front Window..... | 10-20-2 |
| Heating, Ventilation And Air Conditioning Duct | 10-20-5 |
| Right Side Window..... | 10-20-4 |
| Window Washer Reservoir..... | 10-20-4 |
| PIVOT PINS | 10-160-1 |
| Inspection And Maintenance | 10-160-1 |
| RIGHT SIDE COVER | 10-41-1 |
| Adjusting The Bumper | 10-41-1 |
| Adjusting The Latch | 10-41-1 |
| Opening And Closing | 10-41-1 |
| SEAT BELT | 10-150-1 |
| Inspection And Maintenance | 10-150-1 |
| SERVICE SCHEDULE | 10-50-1 |
| Chart | 10-50-1 |
| SPARK ARRESTOR MUFFLER | 10-130-1 |
| Cleaning Procedure | 10-130-1 |
| STOPPING THE ENGINE AND LEAVING THE EXCAVATOR | 10-180-1 |
| Emergency Exits | 10-180-2 |
| Procedure | 10-180-1 |
| TAILGATE | 10-40-1 |
| Adjusting The Bumper | 10-40-1 |
| Adjusting The Latch | 10-40-1 |
| Opening And Closing | 10-40-1 |

Continued On Next Page

SAFETY AND MAINTENANCE (CONT'D)

| | |
|---|----------|
| TRANSPORTING THE EXCAVATOR ON A TRAILER | 10-30-1 |
| Fastening | 10-30-1 |
| Loading And Unloading | 10-30-1 |
| TRAVEL MOTOR | 10-120-1 |
| Checking And Adding Oil | 10-120-1 |
| Removing And Replacing Oil | 10-120-1 |
| UPPERSTRUCTURE SLEW LOCK | 10-11-1 |
| Operation | 10-11-1 |

LIFTING AND BLOCKING THE EXCAVATOR

Procedure

Always park the machine on a level surface.

WARNING

AVOID INJURY OR DEATH

Instructions are necessary before operating or servicing machine. Read and understand the Operation & Maintenance Manual, Operator's Handbook and signs (decals) on machine. Follow warnings and instructions in the manuals when making repairs, adjustments or servicing. Check for correct function after adjustments, repairs or service. Untrained operators and failure to follow instructions can cause injury or death.

W-2003-0807

WARNING

Put jackstands under the front axles and rear corners of the frame before running the engine for service. Failure to use jackstands can allow the machine to fall or move and cause injury or death.

W-2017-0286

Figure 10-10-1

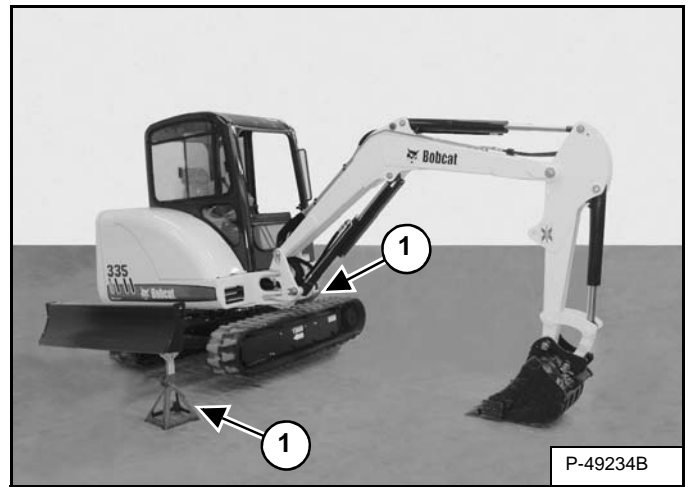

Raise one side of the machine (approximately 4 in.) using the boom and arm [Figure 10-10-1].

Raise the blade fully and install jack stands under the blade and track frame (Item 1) [Figure 10-10-1]. Raise the boom until all machine weight is on the jack stands.

Repeat the procedure for the other side.

Stop the engine.

NOTE: For machines equipped with angle blade, make sure blade is in the straight position prior to lifting.

UPPERSTRUCTURE SLEW LOCK

Operation

Figure 10-11-1

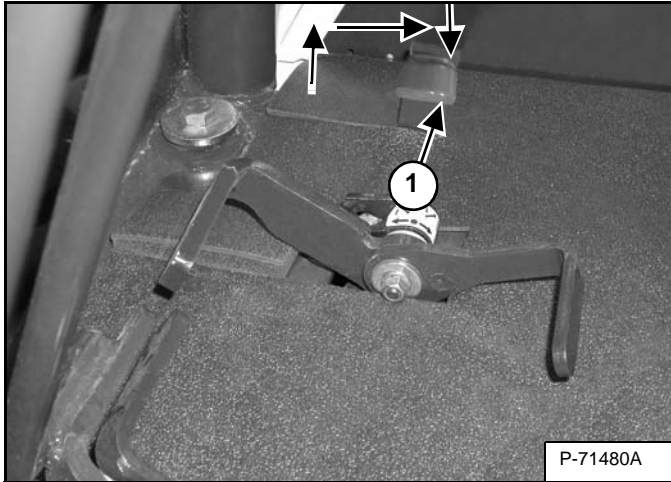

Move the lever (Item 1) [Figure 10-11-1] *up* slightly, then to the rear and down to engage the upperstructure slew lock.

Figure 10-11-2

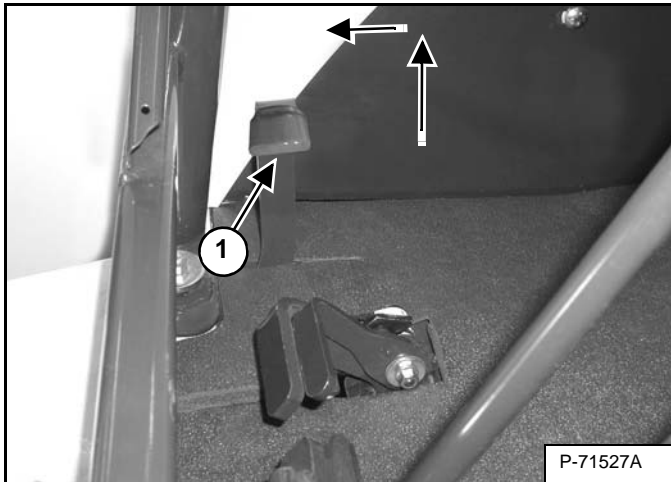

Move the lever (Item 1) [Figure 10-11-2] *up* and then forward to disengage the upperstructure slew lock.

NOTE: Upperstructure must be in the straight forward or straight rearward position for upperstructure to lock.

WARNING

AVOID INJURY

The upperstructure slew lock lever must be engaged when transporting the machine.

W-2197-0904

WARNING

AVOID INJURY OR DEATH

Never use attachments or buckets which are not approved by Bobcat Company. Buckets and attachments for safe loads of specified densities are approved for each model. Unapproved attachments can cause injury or death.

W-2052-0907

LIFTING THE EXCAVATOR

Procedure

Figure 10-12-1

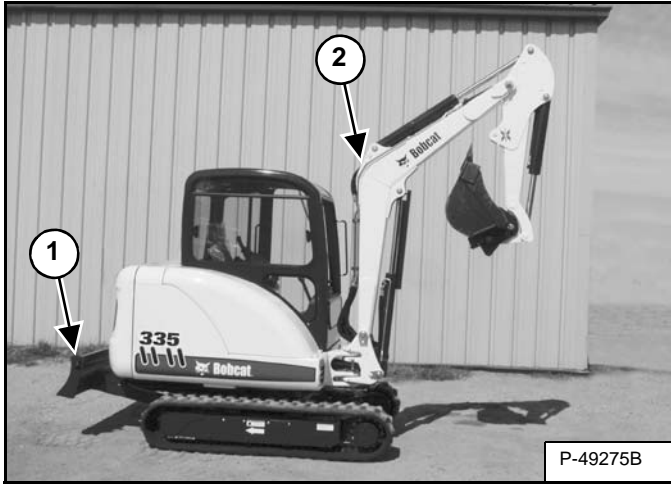

Fully extend the cylinders of the bucket, arm, and boom so that the excavator is in the position as shown [Figure 10-12-1].

Raise the blade all the way.

Put all the control levers in neutral.



AVOID INJURY OR DEATH

- Use a lifting fixture with sufficient capacity for the weight of the excavator plus any added attachments.
- Maintain center of gravity and balance when lifting.
- Do not swing boom or upperstructure. Engage the upperstructure slew lock.
- Never lift with operator on machine.

W-2202-0607

Figure 10-12-2

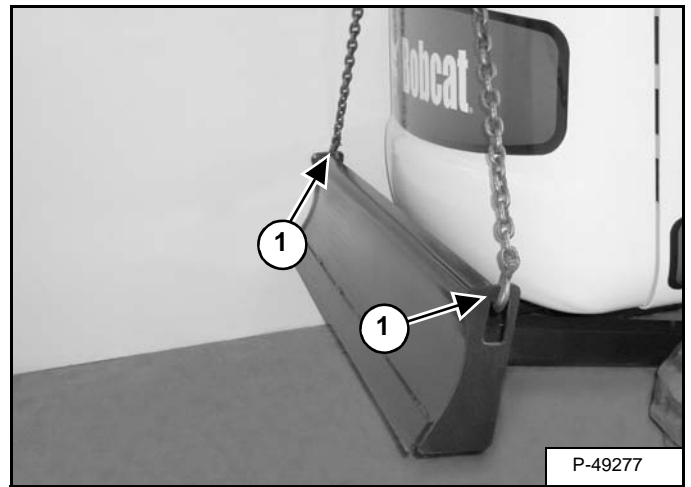
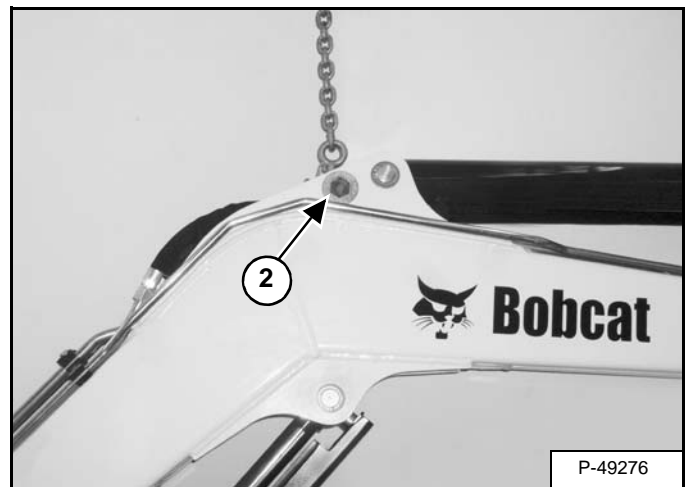

Figure 10-12-3



Fasten chains to the ends of the blade (Item 1) [Figure 10-12-2] and [Figure 10-12-3] and up to a lifting fixture above the canopy/cab. The lifting fixture must extend over the sides of the canopy/cab to prevent the chains from hitting the ROPS/TOPS.

Install a 1 in. (25 mm) bolt and nut (Grade 5 or 8) through the holes in the boom (Item 2) [Figure 10-12-1] and [Figure 10-12-3]. Fasten a chain from the bolt to the lift fixture.

LIFTING THE EXCAVATOR (CONT'D)

Procedure (Cont'd)

Figure 10-12-4

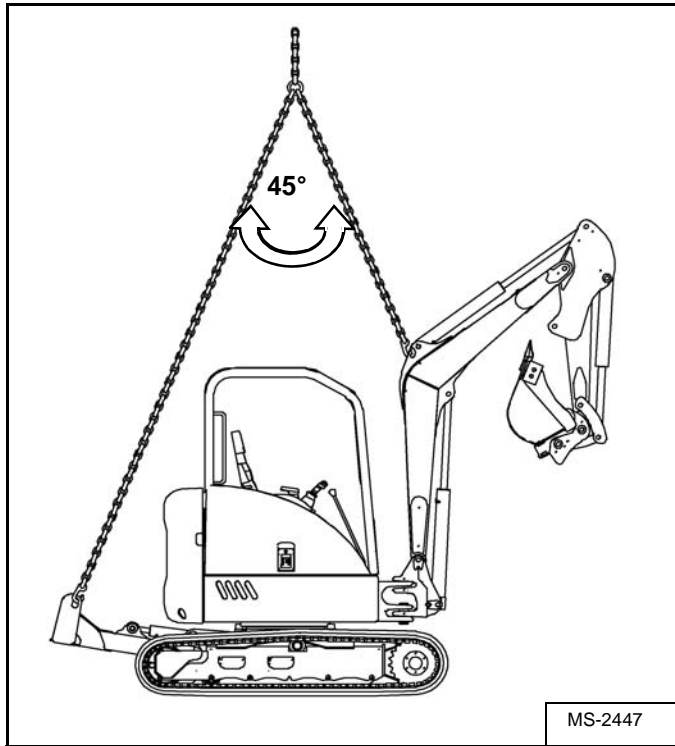

Keep the angle between the front and rear chains less than 45° [Figure 10-12-4].

OPERATOR CAB (ROPS / TOPS)

Description

The excavator has an optional operator cab (ROPS/TOPS) (Roll Over Protective Structure/Tip Over Protective Structure). The ROPS/TOPS meets ISO 3471 and ISO 12117.

An enclosed cab (ROPS/TOPS) is an Option or can be installed as a Field Accessory.

Both the cab and canopy provide operator protection if the excavator is tipped over. The seat belt must be worn for ROPS /TOPS protection.

WARNING

Never modify operator cab by welding, grinding, drilling holes or adding attachments unless instructed to do so by Bobcat Company. Changes to the cab can cause loss of operator protection from rollover and falling objects, and result in injury or death.

W-2069-0200

Cab Door

Figure 10-20-1

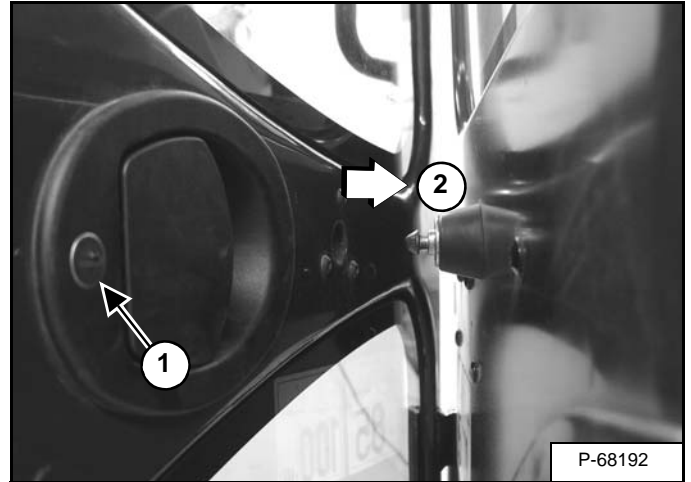

The cab door can be locked (Item 1) [Figure 10-20-1] with the same key as the starter switch.

Push the door all the way open (Item 2) [Figure 10-20-1] until the latch engages to hold the door in the open position.

Figure 10-20-2

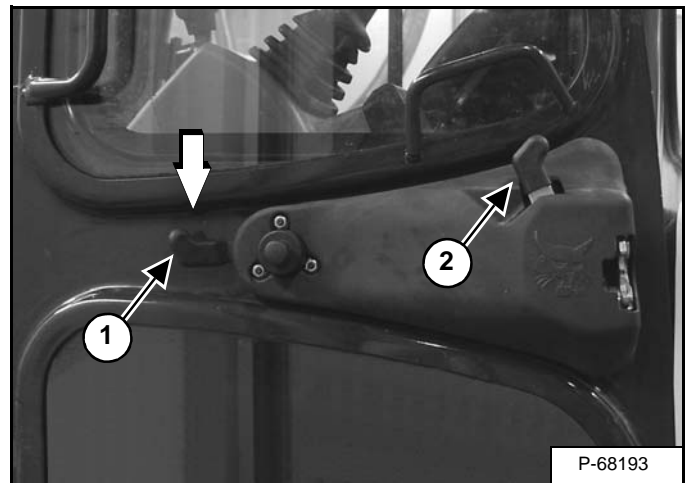

When the door is in the open position, push down on the latch (Item 1) [Figure 10-20-2] and close the door.

From inside the cab, open the door using handle (Item 2) [Figure 10-20-2].

OPERATOR CAB (ROPS / TOPS) (CONT'D)

Front Window

Opening The Front Window

Figure 10-20-3

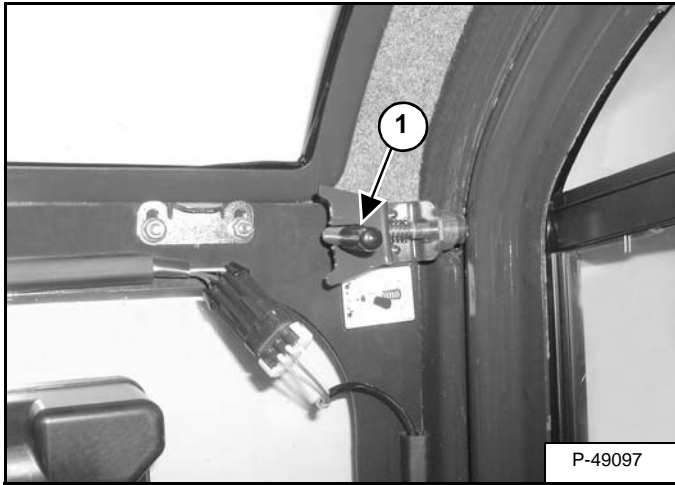

Retract the two top window latch pins (Item 1) [Figure 10-20-3].

Figure 10-20-4

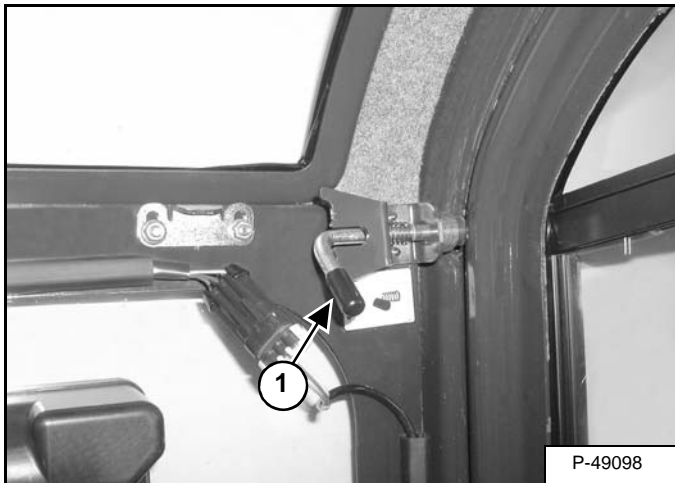

Turn the two top latches (Item 1) [Figure 10-20-4] to the unlocked position.

Figure 10-20-5



Use both window grab handles to pull the top of the window in [Figure 10-20-5].

Continue moving the window in and up over the operator's head until the window is fully raised.

Figure 10-20-6

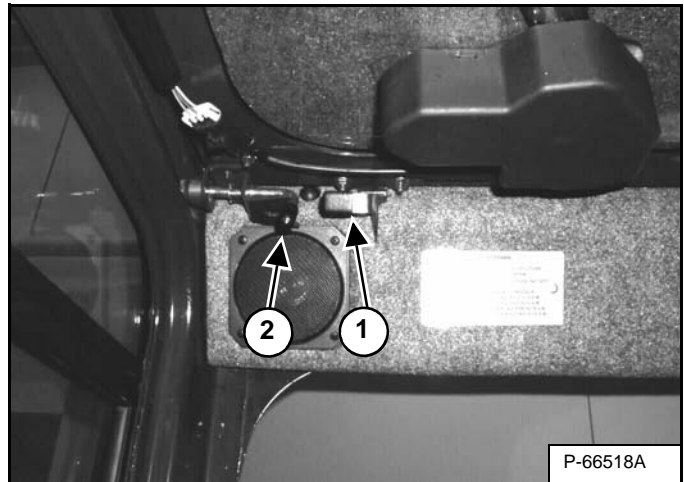

When the window is fully raised, the latch (Item 1) will close on the bracket. Turn the two top latches (Item 2) [Figure 10-20-6] to the locked position.

OPERATOR CAB (ROPS/TOPS) (CONT'D)

Front Window (Cont'd)

Closing The Front Window

Figure 10-20-7

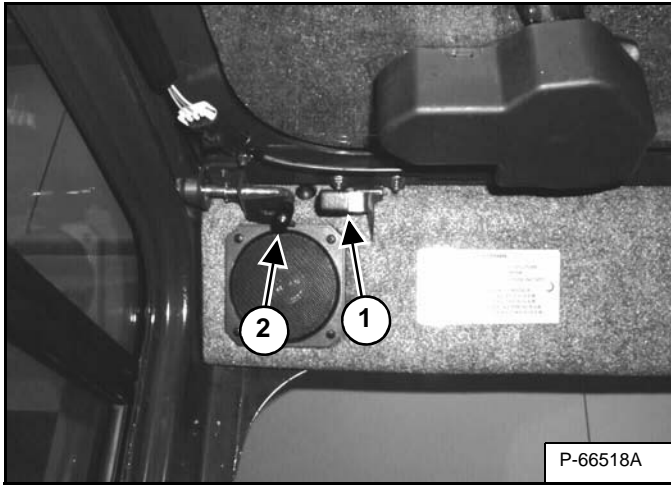

Support the window while releasing both window latch pins and placing the pins in the unlocked position [Figure 10-20-7].

Support the window using the left grab handle and pull down on the latch (Item 1) [Figure 10-20-7] to release the window.

Figure 10-20-8



Use both window grab handles to pull the window down [Figure 10-20-8].

Figure 10-20-9

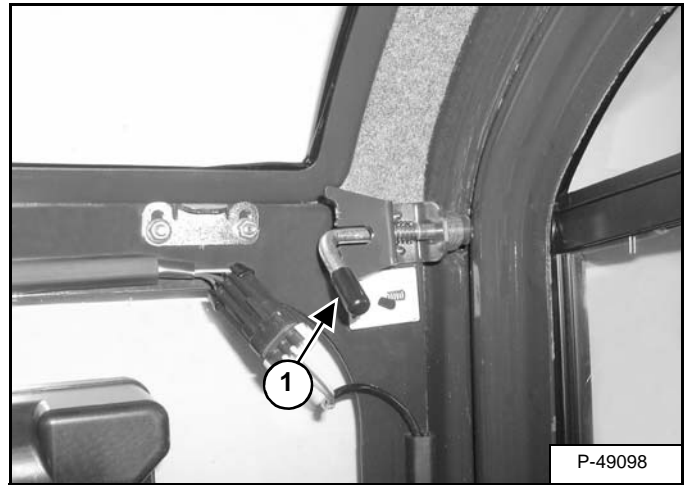
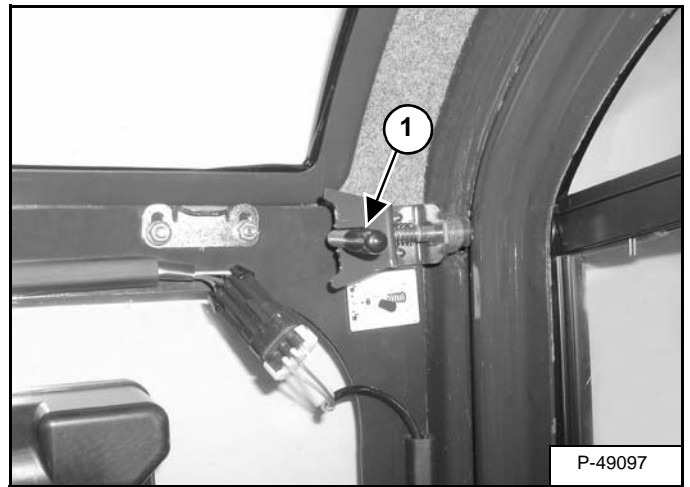

Figure 10-20-10



Rotate the top latches (Item 1) [Figure 10-20-9] to the locked position (Item 1) [Figure 10-20-10].

OPERATOR CAB (ROPS/TOPS) (CONT'D)

Front Wiper

Figure 10-20-11



The front window is equipped with a wiper (Item 1) [Figure 10-20-11] and washer.

Window Washer Reservoir

Figure 10-20-12

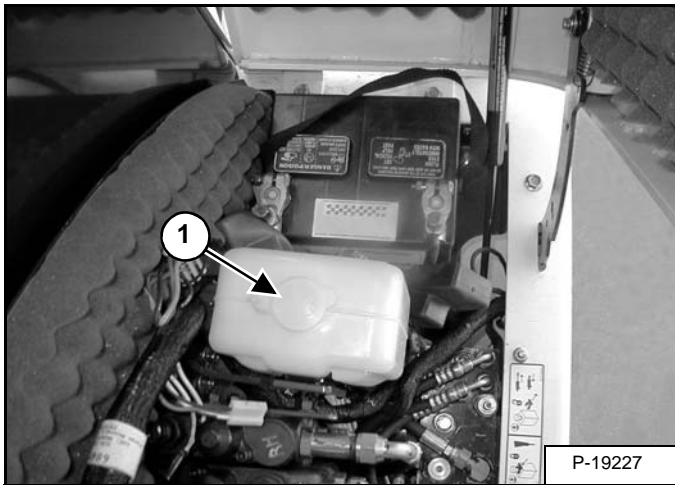

The window washer reservoir (Item 1) [Figure 10-20-12] is located under the right side cover.

Right Side Window

Opening The Right Rear Window

Figure 10-20-13

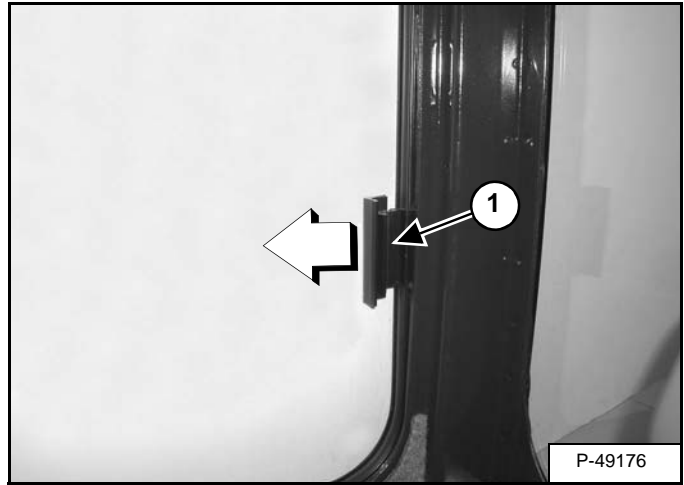

Pull forward on the latch / handle (Item 1) [Figure 10-20-13].

Figure 10-20-14

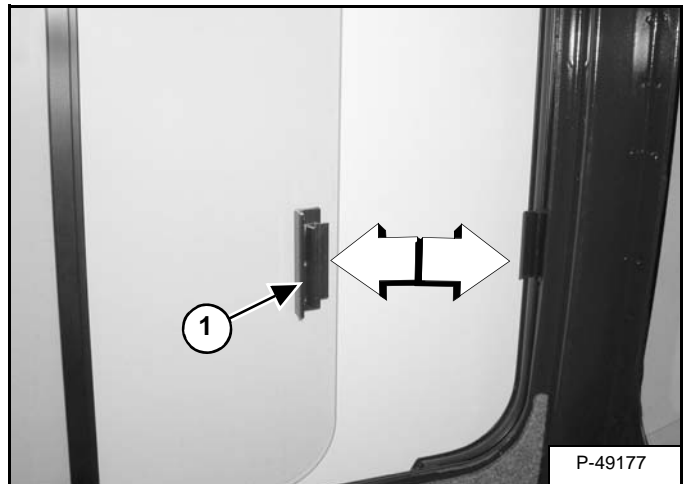

Pull the latch / handle (Item 1) [Figure 10-20-14] forward to open the window.

Closing The Right Rear Window

Push the handle back to close the window.

OPERATOR CAB (ROPS/TOPS) (CONT'D)

Right Side Window (Cont'd)

Opening The Right Front Window

Figure 10-20-15

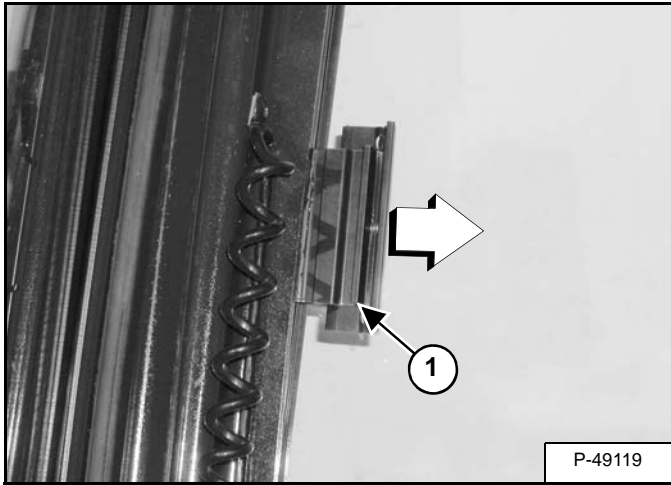

Pull back on the latch / handle (Item 1) [Figure 10-20-15].

Figure 10-20-16

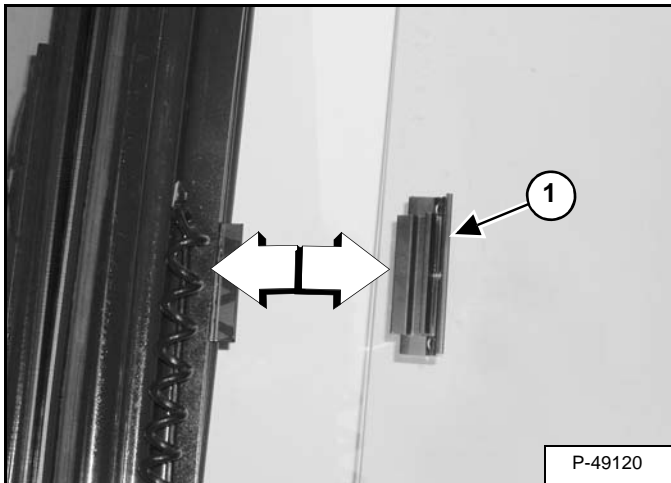

Pull the latch / handle (Item 1) [Figure 10-20-16] back to open the window.

Closing The Right Front Window

Push the handle forward to close the window.

Heating, Ventilation And Air Conditioning Duct

NOTE: The air conditioner duct can be ordered and used on heater models.

There are two air ducts that the operator can choose to install.

Figure 10-20-17

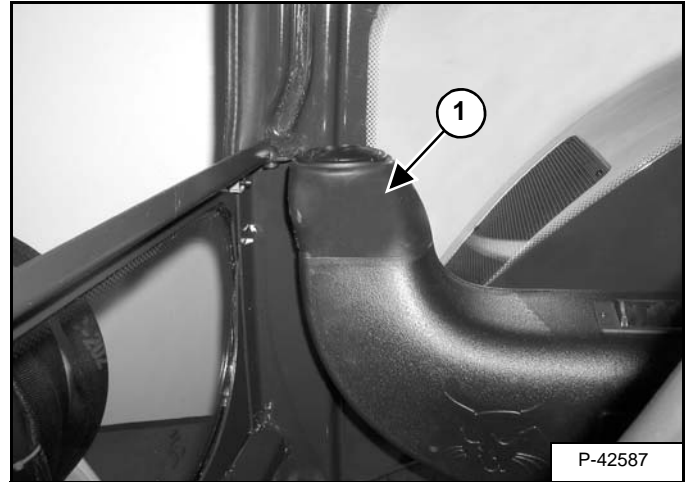

The small duct (Item 1) [Figure 10-20-17] is standard for heater use.

Figure 10-20-18

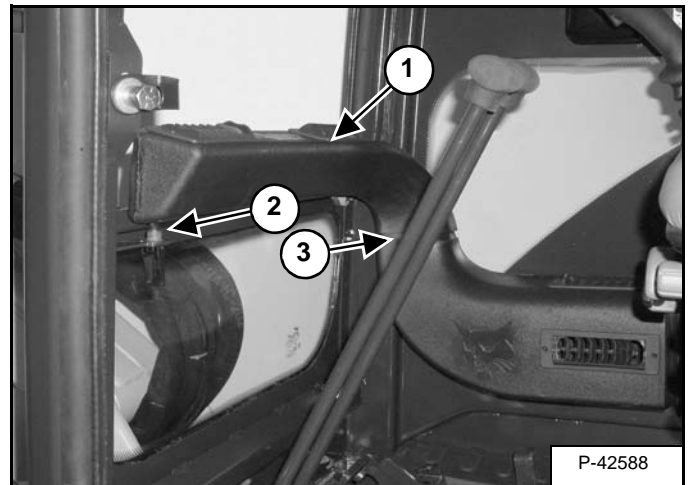

The large duct (Item 1) [Figure 10-20-18] is standard for models that have air conditioner available.

NOTE: This duct (Item 1) [Figure 10-20-18] can be removed for improved operator visibility.

OPERATOR CAB (ROPS/TOPS) (CONT'D)

Heating, Ventilation And Air Conditioning Duct (Cont'd)

Installation

Figure 10-20-19

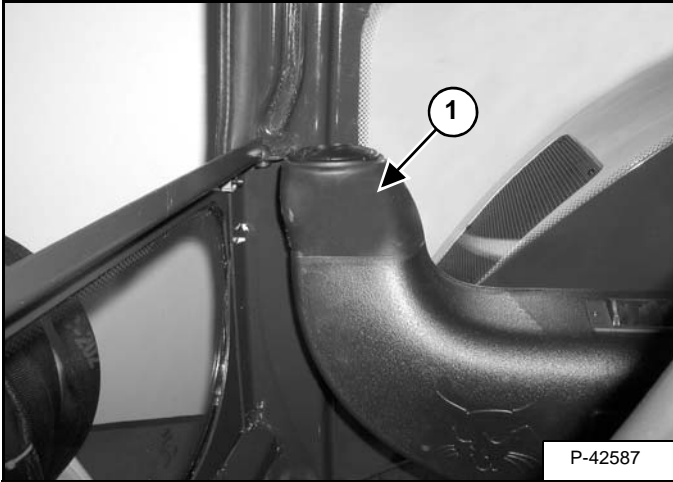

Remove the screw and pull straight up to remove the duct (Item 1) [Figure 10-20-19].

Figure 10-20-20

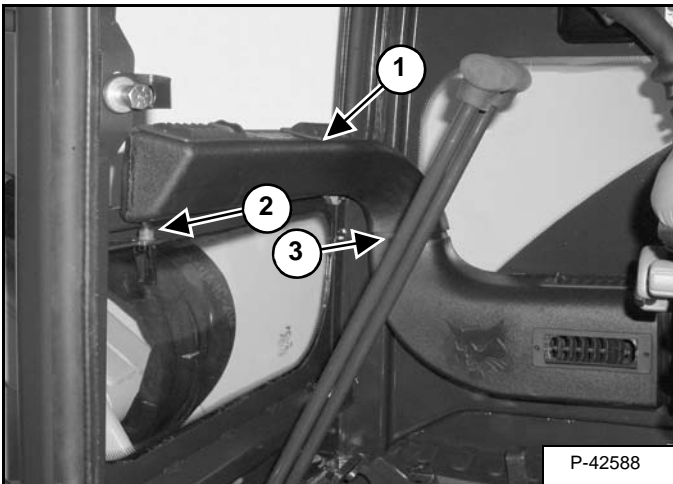

Place the air conditioning duct (Item 1) on the housing and over the locking stud (Item 2) [Figure 10-20-20].

Reinstall the screw (Item 3) [Figure 10-20-20].

Figure 10-20-21

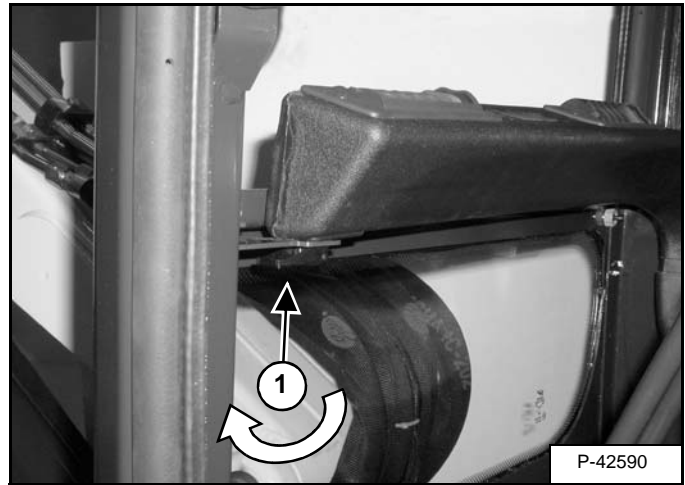

Fully seat the duct and rotate the lock (Item 1) [Figure 10-20-21].

TRANSPORTING THE EXCAVATOR ON A TRAILER

Loading And Unloading

When transporting the machine, observe the rules, motor vehicle laws, and vehicle limit ordinances. Use a transport and towing vehicle of adequate length and capacity.

Secure the parking brakes and block the wheels of the transport vehicle.

Align the ramps with the center of the transport vehicle. Secure the ramps to the truck bed and be sure ramp angle does not exceed 15 degrees.

Use metal loading ramps with a slip resistant surface.

Use ramps that are the correct length and width and can support the weight of the machine.

The rear of the trailer must be blocked or supported when loading or unloading the excavator to prevent the front of the transport vehicle from raising.

Determine the direction of the track movement before moving the machine (blade forward).

Engage the slew lock.

Figure 10-30-1



Move the machine forward onto the transport vehicle **[Figure 10-30-1]**.

Do not change direction of the machine while it is on the ramps.

Lower the boom, arm, bucket, and blade to the transport vehicle. Stop the engine and remove the key (if equipped).

Put blocks at the front and rear of the tracks.

Fastening

Figure 10-30-2

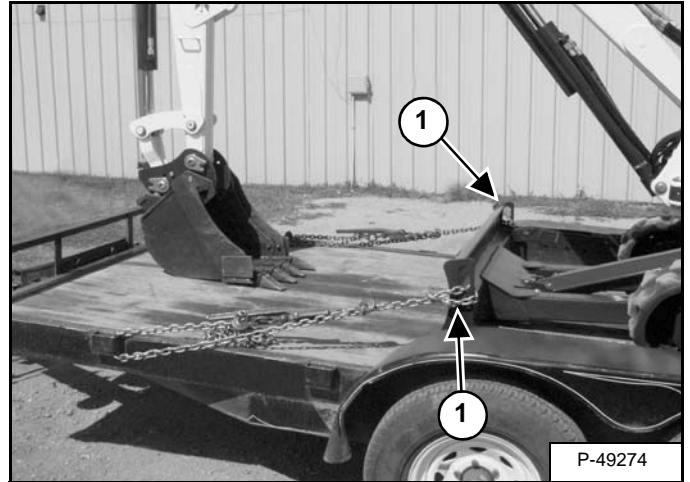
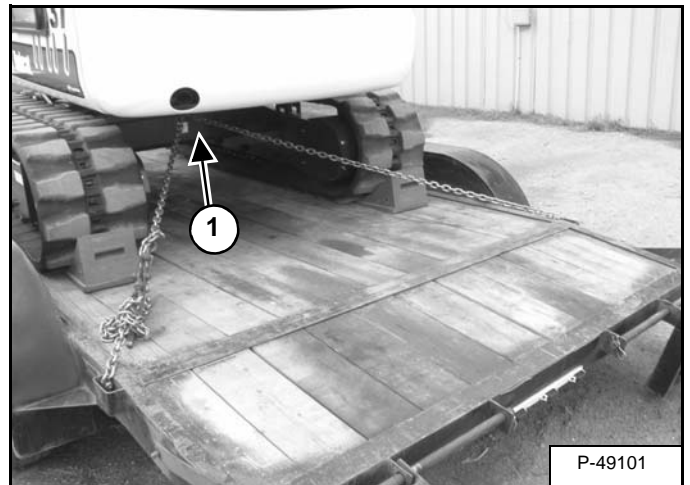

Figure 10-30-3



Fasten chains to the front corners of the blade (Item 1) **[Figure 10-30-2]** and to the tie down loop at the rear of the track frame (Item 1) **[Figure 10-30-3]** to prevent it from moving when going up or down slopes or during sudden stops.

Use chain binders to tighten the chains and then safely tie the chain binder levers to prevent loosening.

WARNING

AVOID SERIOUS INJURY OR DEATH
Adequately designed ramps of sufficient strength are needed to support the weight of the machine when loading onto a transport vehicle. Wood ramps can break and cause personal injury.

W-2058-0807



Suggest:

If the above button click is invalid.

Please download this document

first, and then click the above link

to download the complete manual.

Thank you so much for reading

TAILGATE

Opening And Closing



AVOID INJURY OR DEATH

Never service or adjust the machine when the engine is running unless instructed to do so in the manual.

W-2012-0497



Keep the rear door closed when operating the machine. Failure to do so could seriously injure a bystander.

W-2020-1285

Figure 10-40-1

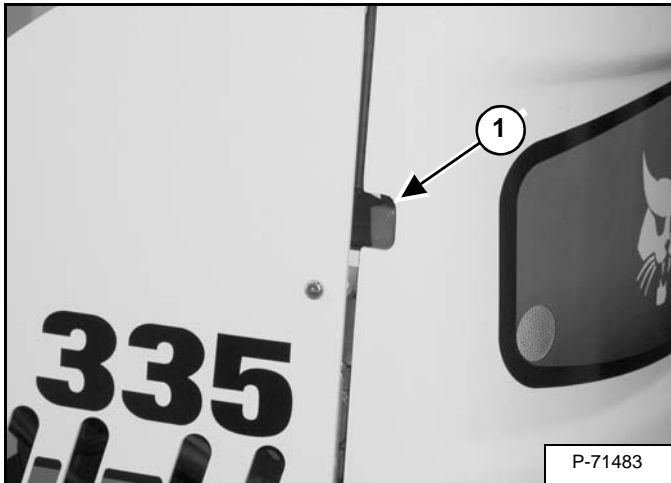

Pull the latch (Item 1) [Figure 10-40-1] and open the tailgate.

Push firmly to close the tailgate.

NOTE: The tailgate can be locked using the start key.

Adjusting The Bumper

Figure 10-40-2

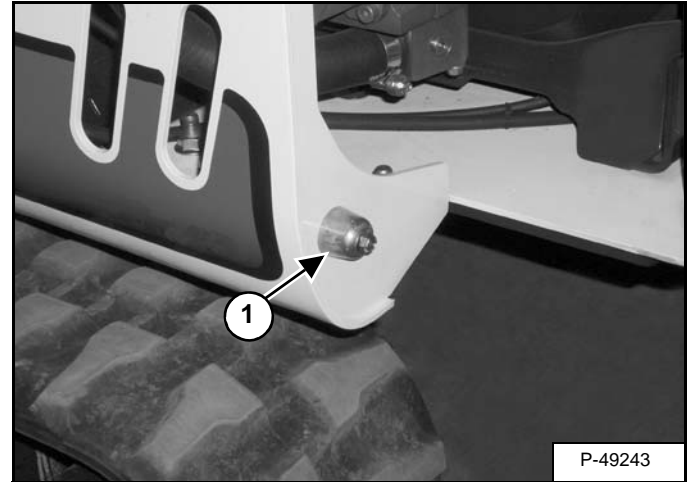

The door bumper (Item 1) [Figure 10-40-2] can be adjusted for alignment with the tailgate.

Close the tailgate before operating the excavator.

Adjusting The Latch

Figure 10-40-3

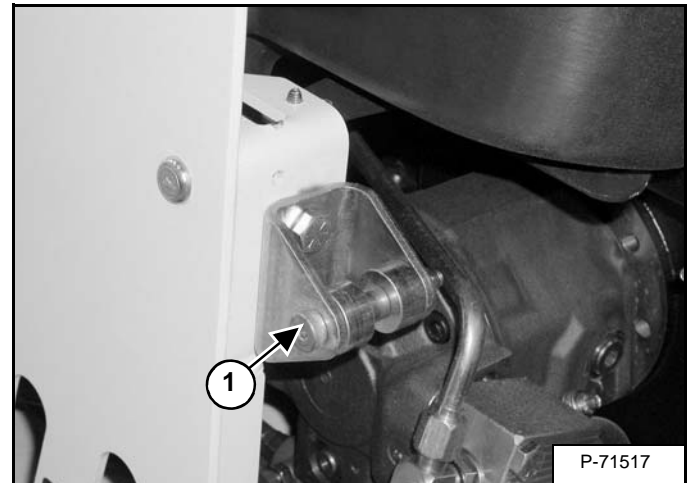

The door latch (Item 1) [Figure 10-40-3] can be adjusted for alignment.

Close the tailgate before operating the excavator.

<https://www.ebooklibonline.com>

Hello dear friend!

Thank you very much for reading.

Enter the link into your browser.

The full manual is available for immediate download.

<https://www.ebooklibonline.com>