



Bobcat®

Service Manual

325, 328 Compact Excavator

325 S/N AAC511001 & Above

325 S/N A9K011001 & Above

328 S/N A9K111001 & Above

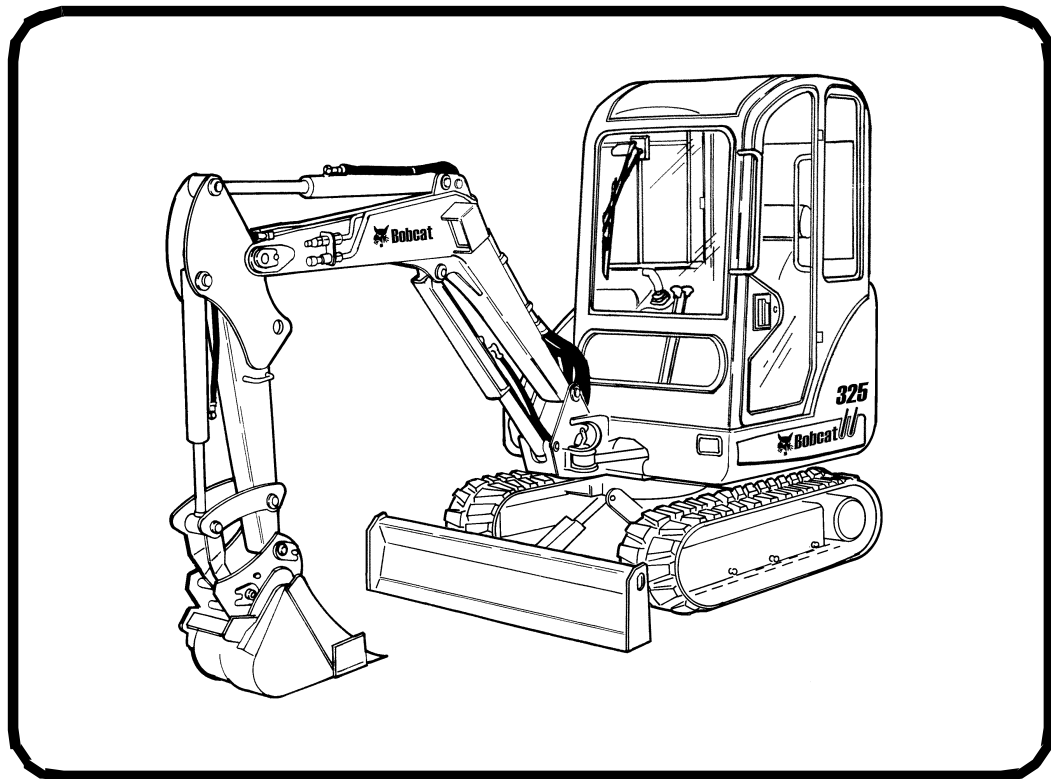

MAINTENANCE SAFETY



WARNING

Instructions are necessary before operating or servicing machine. Read and understand the Operation & Maintenance Manual, Operator's Handbook and signs (decals) on machine. Follow warnings and instructions in the manuals when making repairs, adjustments or servicing. Check for correct function after adjustments, repairs or service. Untrained operators and failure to follow instructions can cause injury or death.

W-2003-0903



Safety Alert Symbol: This symbol with a warning statement, means: "Warning, be alert! Your safety is involved!" Carefully read the message that follows.

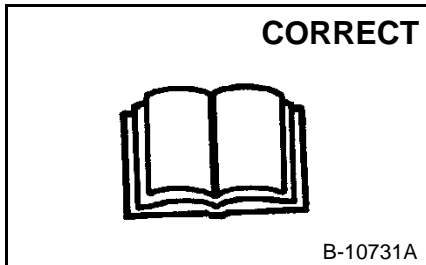

B-10731A

- ⚠ Never service the Bobcat Compact Excavator without instructions.

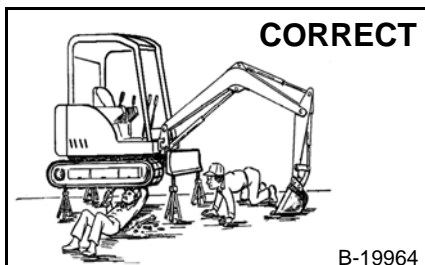

B-19964

- ⚠ Use the correct procedure to lift and support the excavator.

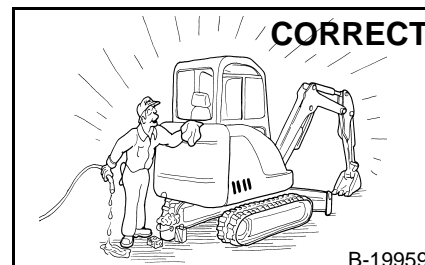

B-19959

- ⚠ Cleaning and maintenance are required daily.

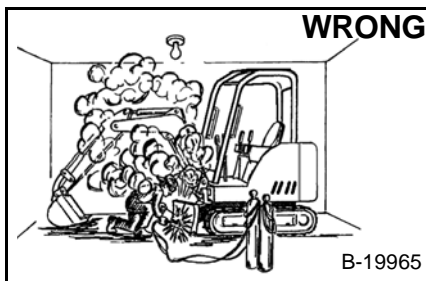

B-19965

- ⚠ Have good ventilation when welding or grinding painted parts.
- ⚠ Wear dust mask when grinding painted parts. Toxic dust and gas can be produced.

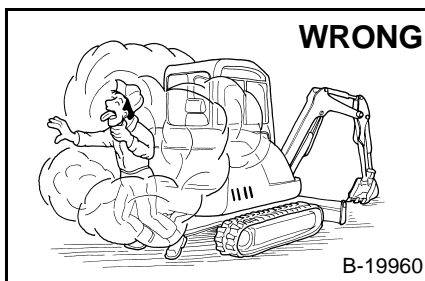

B-19960

- ⚠ Vent exhaust to outside when engine must be run for service.
- ⚠ Exhaust system must be tightly sealed. Exhaust fumes can kill without warning.

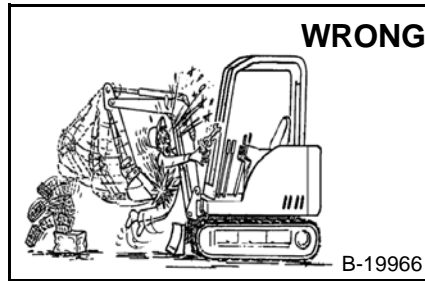

B-19966

- ⚠ Always lower the bucket and blade to the ground before doing any maintenance.
- ⚠ Never modify equipment or add attachments not approved by Bobcat Company.

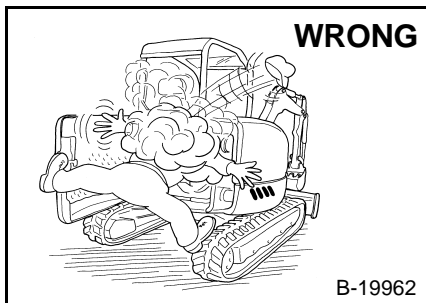

B-19962

- ⚠ Stop, cool and clean engine of flammable materials before checking fluids.
- ⚠ Never service or adjust machine with the engine running unless instructed to do so in the manual.
- ⚠ Avoid contact with leaking hydraulic fluid or diesel fuel under pressure. It can penetrate the skin or eyes.
- ⚠ Never fill fuel tank with engine running, while smoking, or when near open flame.

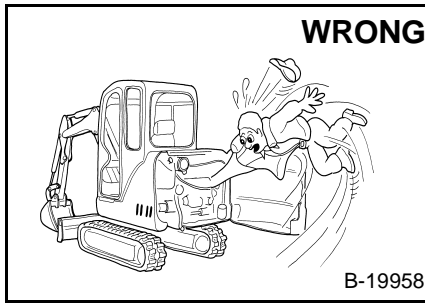

B-19958

- ⚠ Keep body, jewelry and clothing away from moving parts, electrical contact, hot parts and exhaust.
- ⚠ Wear eye protection to guard from battery acid, compressed springs, fluids under pressure and flying debris when engines are running or tools are used. Use eye protections approved for type of welding.
- ⚠ Keep tailgate closed except for service. Close and latch tailgate before operating the excavator.

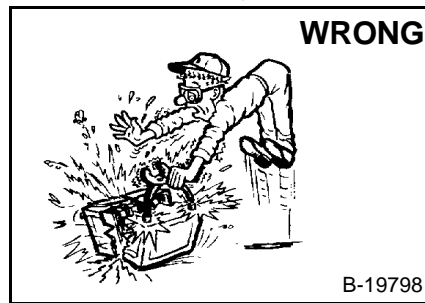

B-19798

- ⚠ Lead-acid batteries produce flammable and explosive gases.
- ⚠ Keep arcs, sparks, flames and lighted tobacco away from batteries.
- ⚠ Batteries contain acid which burns eyes or skin on contact.
- ⚠ Wear protective clothing. If acid contacts body, flush well with water. For eye contact flush well and get immediate medical attention.

Maintenance procedures which are given in the Operation & Maintenance Manual can be performed by the owner/operator without any specific technical training. Maintenance procedures which are **not** in the Operation & Maintenance Manual must be performed **ONLY BY QUALIFIED BOBCAT SERVICE PERSONNEL**. Always use genuine Bobcat replacement parts. The Service Safety Training Course is available from your Bobcat dealer.

MSW28-0805

ALPHABETICAL INDEX

AIR CLEANER	10-01, 60-01	HEATER AIR FILTER (WITH CAB OPTION ONLY)	10-01
AIR CLEANER SERVICE	10-01	HEATER COIL	70-01
ALTERNATOR	50-01	HEATER FAN	70-01
ARM	40-01	HEATER UNIT	70-01
ARM CYLINDER	20-01	HEATER VALVE	70-01
BATTERY	50-01	HORN	40-01
BLADE	30-01	HYDRAULIC CONTROL VALVE	20-01
BLADE CONTROL	40-01	HYDRAULIC CONNECTION SPECS	SPEC-01
BLADE CYLINDER	20-01	HYDRAULIC FLUID SPECIFICATIONS.....	SPEC-01
BOOM	40-01	HYDRAULIC FILTER MOUNT.....	20-01
BOOM CYLINDER	20-01	HYDRAULIC PUMP	20-01
BOOM SWING CYLINDER.....	20-01	HYDRAULIC PUMP START-UP	20-01
BUCKET	40-01	HYDRAULIC RESERVOIR.....	20-01
BUCKET CYLINDER	20-01	HYDRAULIC SYSTEM	10-01
BUILD UP VALVE	20-01	HYDRAULIC SYSTEM INFORMATION	20-01
CAB.....	40-01	LEFT CONTROL LEVER (JOYSTICK)	20-01
CASE DRAIN FILTER	20-01	LEFT CONSOLE	40-01
CLAMP CYLINDER	20-01	LIFTING AND BLOCKING THE EXCAVATOR	10-01
CONVERSIONS	SPEC-01	LIFTING THE EXCAVATOR	10-01
CONTROL PATTERN SELECTOR VALVE	20-01	LIGHTS.....	50-01
COOLING SYSTEM.....	10-01	LUBRICATION OF THE HYDRAULIC EXCAVATOR	10-01
CROSS PORT RELIEF VALVES	20-01	10-01
DELUXE INSTRUMENT PANEL SETUP.....	50-01	MAIN RELIEF VALVES.....	20-01
DIAGNOSTICS SERVICE CODE	50-01	MANIFOLD ASSEMBLY/ACCUMULATOR	20-01
DIRECT TO TANK VALVE	20-01	MUFFLER.....	60-01
ELECTRICAL SYSTEM INFORMATION	50-01	OIL COOLER.....	20-01
ENGINE	60-01	OPERATOR CAB (ROPS/TOPS)	10-01
ENGINE ACCESSORY DRIVE BELT	10-01	PORT RELIEF VALVES.....	20-01
ENGINE COMPONENTS AND TESTING	60-01	PRESSURE REDUCING VALVE.....	20-01
ENGINE FLYWHEEL	60-01	RADIATOR	60-01
ENGINE LUBRICATION SYSTEM.....	10-01	RECONDITIONING THE ENGINE	60-01
ENGINE SPECIFICATIONS.....	SPEC-01	RIGHT CONTROL LEVER (JOYSTICK)	20-01
ENGINE SPEED CONTROL	40-01	RIGHT CONSOLE	40-01
FLOOR MAT AND FLOOR PLATE	40-01	RIGHT PEDAL AND LINKAGE	40-01
FUEL, COOLANT AND LUBRICANTS	SPEC-01	RIGHT SIDE COVER	10-01, 40-01
FUEL LEVEL SENDER.....	50-01	ROPS CANOPY.....	40-01
FUEL SYSTEM	10-01		
FUEL TANK.....	40-01		

Continued On Next Page

<https://www.ebooklibonline.com>

Hello dear friend!

Thank you very much for reading.

Enter the link into your browser.

The full manual is available for immediate download.

<https://www.ebooklibonline.com>

ALPHABETICAL INDEX (CONT'D)

SEAT BELT	10-01
SERVICE SCHEDULE	10-01
SPARK ARRESTOR MUFFLER	10-01
SPECIFICATIONS	SPEC-01
SUSPENSION SEAT AND SEAT MOUNT	40-01
STARTER	50-01
STANDARD SEAT AND SEAT MOUNT	40-01
SWING CIRCLE GEAR	30-01
SWING FRAME	40-01
SWING MOTOR	20-01
SWING MOTOR DRIVE CARRIER	20-01
SWIVEL JOINT	20-01
TAILGATE	10-01, 40-01
TORQUE SPECIFICATIONS	SPEC-01
TRACK DAMAGE IDENTIFICATION	30-01
TRACK FRAME	30-01
TRACK IDLER	30-01
TRACK ROLLER	30-01
TRACKS	30-01
TRANSPORTING THE EXCAVATOR	10-01
TRAVEL CONTROLS	40-01
TRAVEL MOTOR	10-01, 20-01
TROUBLESHOOTING	60-01
TWO SPEED SWITCH	50-01
UPPERSTRUCTURE	40-01
UPPERSTRUCTURE SLEW LOCK	10-01, 40-01
X-CHANGE ®	40-01

CONTENTS

FOREWORD.....	III
SAFETY INSTRUCTIONS	V
FIRE PREVENTION	VII
SERIAL NUMBER LOCATIONS	IX
DELIVERY REPORT.....	X
BOBCAT EXCAVATOR IDENTIFICATION	XI
SAFETY AND MAINTENANCE.....	10-01
HYDRAULIC SYSTEM	20-01
UNDERCARRIAGE.....	30-01
UPPERSTRUCTURE & SWING SECTION	40-01
ELECTRICAL SYSTEM AND ANALYSIS	50-01
ENGINE SERVICE	60-01
HEATER	70-01
SPECIFICATIONS.....	SPEC-01

**SAFETY AND
MAINTENANCE**

**HYDRAULIC
SYSTEM**

UNDERCARRIAGE

**UPPERSTRUCTURE
& SWING
SECTION**

**ELECTRICAL
SYSTEM AND
ANALYSIS**

**ENGINE
SERVICE**

HEATER

SPECIFICATIONS

FOREWORD

This manual is for the Bobcat Hydraulic Excavator mechanic. It provides necessary servicing and adjustment procedures for the hydraulic excavator and its component parts and systems. Refer to the Operation & Maintenance Manual for operating instructions, starting procedure, daily checks, etc.

A general inspection of the following items must be made after the hydraulic excavator has had service or repair:

1. Check that the ROPS/TOPS/FOPS is in good condition and is not modified.

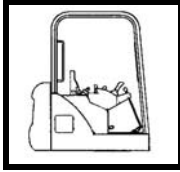

2. Check that ROPS/TOPS mounting hardware is tightened and is Bobcat approved.

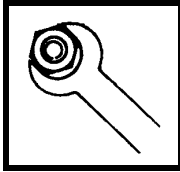

3. The seat belt must be correctly installed, functional and in good condition.

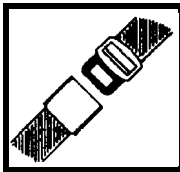

4. Inspect for loose or broken parts or connections.

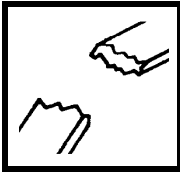

5. Machine signs must be legible and in the correct location.



6. Steering levers, control levers and foot pedals must return to neutral. Check that foot pedals lock and control lever locks are in working order.

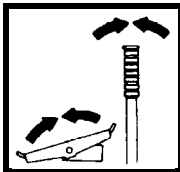

7. Inspect the air cleaner for damage or leaks. Check the condition of the element.

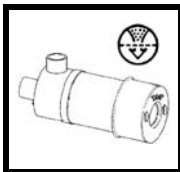

8. Check the electrical charging system.

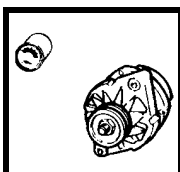

9. Safety treads must be in good condition.

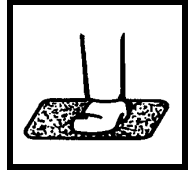

10. Check for correct function of indicator lamps (Optional on some models).

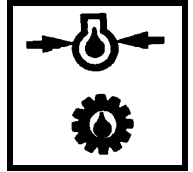

11. Check hydraulic fluid level, engine oil level and fuel supply.

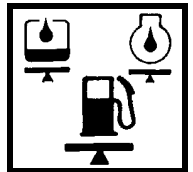

12. Inspect for fuel, oil or hydraulic fluid leaks.



13. Lubricate the excavator.

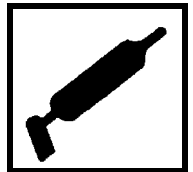

14. Check the condition of the battery and cables.

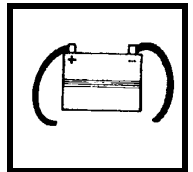

Recommend to the owner that all necessary corrections be made before the machine is returned to service.

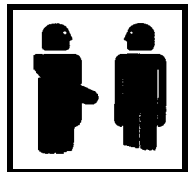

**CALIFORNIA
PROPOSITION 65 WARNING**
Diesel engine exhaust and some of its constituents are known to the state of California to cause cancer, birth defects and other reproductive harm.

SAFETY INSTRUCTIONS



Safety Alert Symbol

This symbol with a warning statement means:
“Warning, be alert! Your safety is involved!”
Carefully read the message that follows.



WARNING

Instructions are necessary before operating or servicing machine. Read and understand the Operation & Maintenance Manual, Operator's Handbook and signs (decals) on machine. Follow warnings and instructions in the manuals when making repairs, adjustments or servicing. Check for correct function after adjustments, repairs or service. Untrained operators and failure to follow instructions can cause injury or death.

W-2003-0903



WARNING

Warnings on the machine and in the manuals are for your safety. Failure to obey warnings can cause injury or death.

W-2044-1285

IMPORTANT

This notice identifies procedures which must be followed to avoid damage to the machine.

I-2019-0284

The following publications provide information on the safe use and maintenance of the Bobcat machine and attachments:

- The Delivery Report is used to assure that complete instructions have been given to the new owner and that the machine is in safe operating condition.
- The Operation & Maintenance Manual delivered with the machine or attachment contains operating information as well as routine maintenance and service procedures. It is a part of the machine and can be stored in a container provided on the machine. Replacement Operation & Maintenance Manuals can be ordered from your Bobcat dealer.
- Machine signs (decals) instruct on the safe operation and care of your Bobcat machine or attachment. The signs and their locations are shown in the Operation & Maintenance Manual. Replacement signs are available from your Bobcat dealer.
- An Operator's Handbook fastened to the operator cab. It's brief instructions are convenient to the operator. The handbook is available from your dealer in an English edition or one of many other languages. See your Bobcat dealer for more information on translated versions.
- The AEM Safety Manual delivered with the machine gives general safety information.
- The Service Manual and Parts Manual are available from your dealer for use by mechanics to do shop-type service and repair work.
- The Compact Excavator Operator Training Course is available through your local dealer or at www.training.bobcat.com or www.bobcat.com. This course is intended to provide rules and practices of correct operation of the Bobcat excavator. The course is available in English and Spanish versions.
- Service Safety Training Courses are available from your Bobcat dealer or at www.training.bobcat.com or www.bobcat.com. They provide information for safe and correct service procedures.
- The Bobcat compact excavator Safety Video is available from your Bobcat dealer or at www.training.bobcat.com or www.bobcat.com.

SI EXC-1007 SM

SAFETY INSTRUCTIONS (CONT'D)

The dealer and owner / operator review the recommended uses of the product when delivered. If the owner / operator will be using the machine for a different application(s) he or she must ask the dealer for recommendations on the new use.



Cutting or drilling concrete containing sand or rock containing quartz may result in exposure to silica dust. Do not exceed Permissible Exposure Limits (PEL) to silica dust as determined by OSHA or other job site Rules and Regulations. Use a respirator, water spray or other means to control dust. Silica dust can cause lung disease and is known to the state of California to cause cancer.

Call Before You Dig
Dial 811 (USA Only)
1-888-258-0808 (USA & Canada)

When you call, you will be directed to a location in your state / province, or city for information about buried lines (telephone, cable TV, water, sewer, gas, etc.).

FIRE PREVENTION



Maintenance

The machine and some attachments have components that are at high temperatures under normal operating conditions. The primary source of high temperatures is the engine and exhaust system. The electrical system, if damaged or incorrectly maintained, can be a source of arcs or sparks.

Flammable debris (leaves, straw, etc.) must be removed regularly. If flammable debris is allowed to accumulate, it can cause a fire hazard. Clean often to avoid this accumulation. Flammable debris in the engine compartment is a potential fire hazard.

The operator's area, engine compartment and engine cooling system must be inspected every day and cleaned if necessary to prevent fire hazards and overheating.

All fuels, most lubricants and some coolants mixtures are flammable. Flammable fluids that are leaking or spilled onto hot surfaces or onto electrical components can cause a fire.

Operation

Do not use the machine where exhaust, arcs, sparks or hot components can contact flammable material, explosive dust or gases.

Electrical



Check all electrical wiring and connections for damage. Keep the battery terminals clean and tight. Repair or replace any damaged part or wires that are loose or frayed.

Battery gas can explode and cause serious injury. Use the procedure in the Operation & Maintenance Manual for connecting the battery and for jump starting. Do not jump start or charge a frozen or damaged battery. Keep any open flames or sparks away from batteries. Do not smoke in battery charging area.

Hydraulic System

Check hydraulic tubes, hoses and fittings for damage and leakage. Never use open flame or bare skin to check for leaks. Hydraulic tubes and hoses must be properly routed and have adequate support and secure clamps. Tighten or replace any parts that show leakage.

Always clean fluid spills. Do not use gasoline or diesel fuel for cleaning parts. Use commercial nonflammable solvents.

Fueling



Stop the engine and let it cool before adding fuel. No smoking! Do not refuel a machine near open flames or sparks. Fill the fuel tank outdoors.

Starting

Do not use ether or starting fluids on any engine that has glow plugs. These starting aids can cause explosion and injure you or bystanders.

Use the procedure in the Operation & Maintenance Manual for connecting the battery and for jump starting.

Spark Arrestor Exhaust System

The spark arrestor exhaust system is designed to control the emission of hot particles from the engine and exhaust system, but the muffler and the exhaust gases are still hot.

Check the spark arrestor exhaust system regularly to make sure it is maintained and working properly. Use the procedure in the Operation & Maintenance Manual for cleaning the spark arrestor muffler (if equipped).

FIRE PREVENTION (CONT'D)

Welding And Grinding

Always clean the machine and attachment, disconnect the battery, and disconnect the wiring from the Bobcat controllers before welding. Cover rubber hoses, battery and all other flammable parts. Keep a fire extinguisher near the machine when welding.

Have good ventilation when grinding or welding painted parts. Wear dust mask when grinding painted parts. Toxic dust or gas can be produced.

Dust generated from repairing nonmetallic parts such as hoods, fenders or covers can be flammable or explosive. Repair such components in a well ventilated area away from open flames or sparks.

Fire Extinguishers

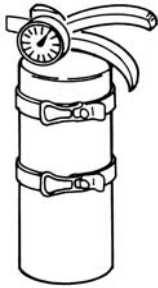

Know where fire extinguishers and first aid kits are located and how to use them. Inspect the fire extinguisher and service the fire extinguisher regularly. Obey the recommendations on the instructions plate.

SERIAL NUMBER LOCATIONS

Always use the serial number of the excavator when requesting service information or when ordering parts. Early or later models (identification made by serial number) may use different parts, or it may be necessary to use a different procedure in doing a specific service operation.

Excavator Serial Number

Figure 1

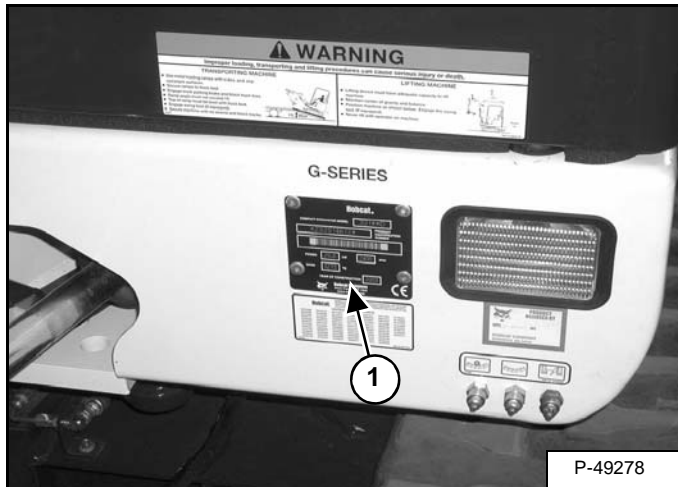

The excavator serial number plate (Item 1) is located on the frame of the machine in the location shown [Figure 1].

Explanation of Excavator Serial Number:

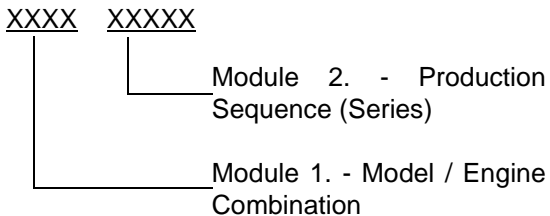

1. The 4 digit Model/Engine Combination Module number identifies the model number and engine combination.
2. The 5 digit Production Sequence Number identifies the order which the excavator is produced.

Engine Serial Number

Figure 2

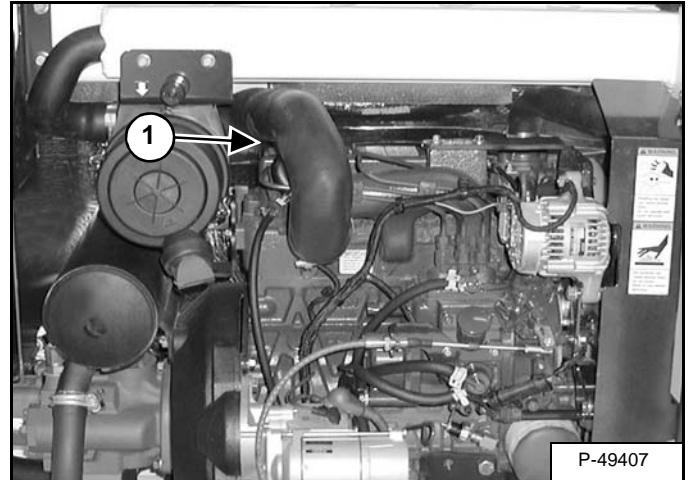
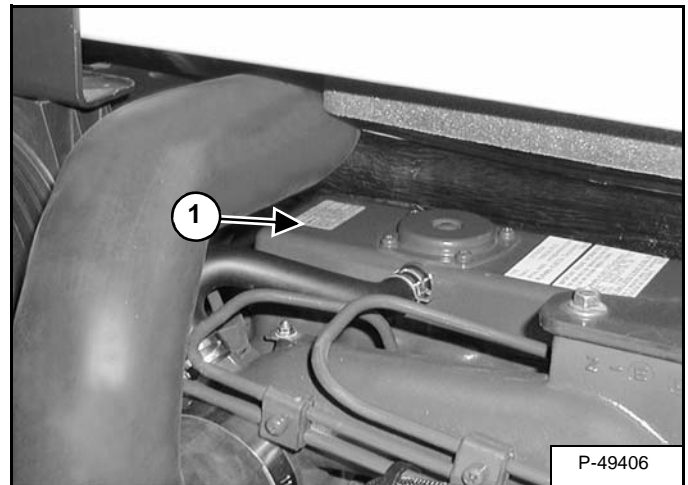

Figure 3



The engine serial number (Item 1) [Figure 2] & [Figure 3] is located on the engine in the locations shown.

DELIVERY REPORT

Figure 4

The diagram shows a form titled "DELIVERY REPORT". The form is divided into several sections. At the top, there is a header section with the title "DELIVERY REPORT". Below this, there are two columns of horizontal lines representing text input fields. On the left side, there is a section with a dark header containing the word "WARNING" in white capital letters, followed by several lines of text. At the bottom right of the form, there is a small rectangular box containing the alphanumeric code "B-16315".

The delivery report must be filled out by the dealer and signed by the owner or operator when the Bobcat Excavator is delivered. An explanation of the form must be given to the owner. Make sure it is filled out completely **[Figure 4]**.

BOBCAT EXCAVATOR IDENTIFICATION

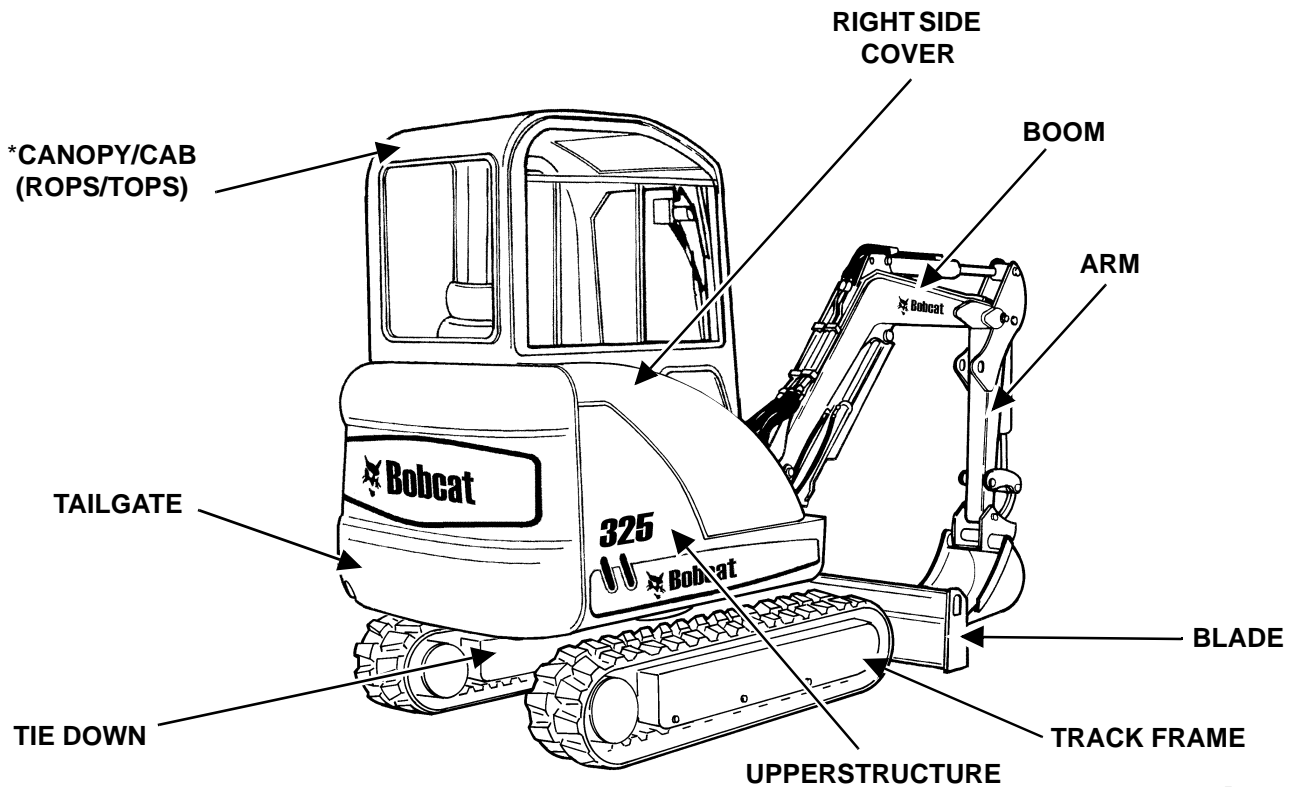
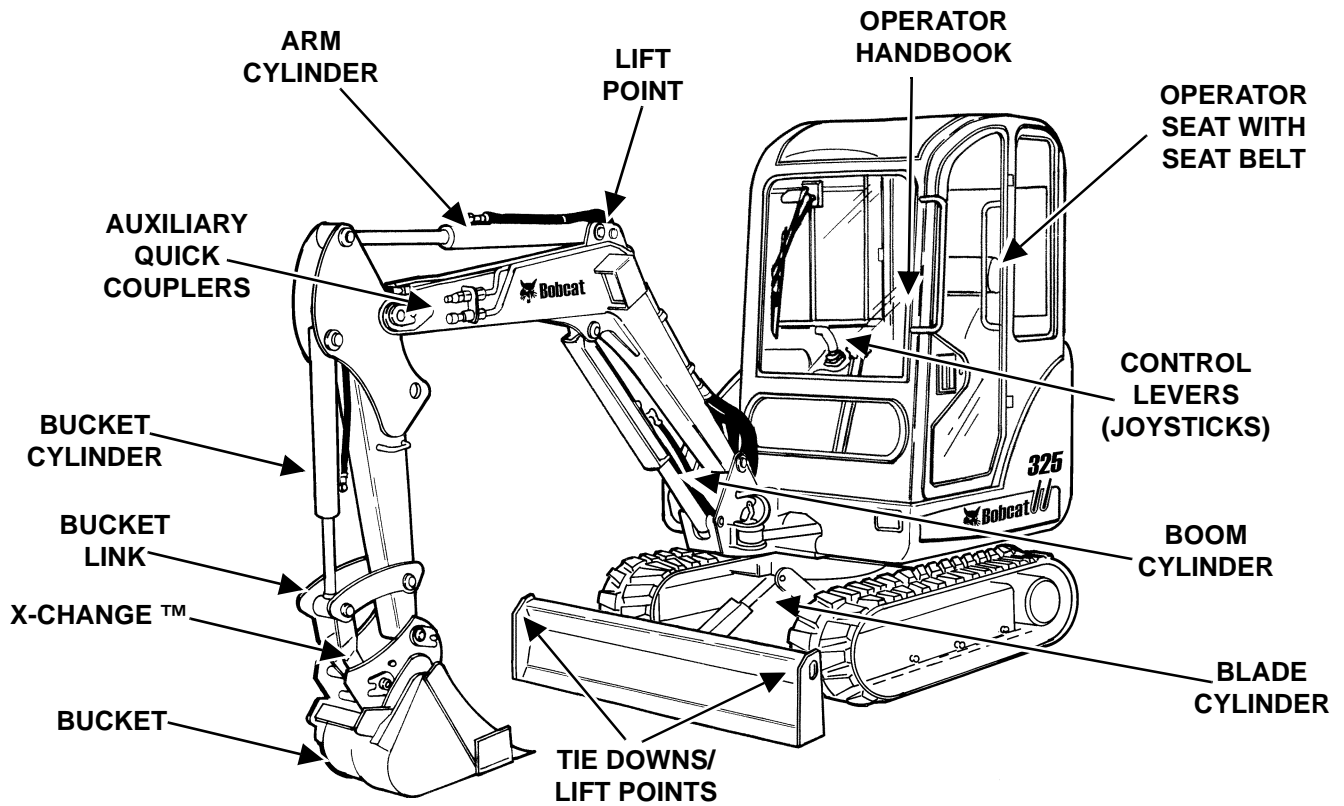

B-19951
B-19950

* FOGS (Falling Object Guards) is available from your Bobcat Excavator dealer.

AIR CLEANER 10-60-1
 Daily Check 10-60-1
 Replacing The Filters. 10-60-1

COOLING SYSTEM 10-70-1
 Checking Coolant Level. 10-70-2
 Cleaning The Cooling System 10-70-1
 Replacing The Coolant 10-70-3

ENGINE ACCESSORY DRIVE BELT 10-140-1
 Belt Adjustment 10-140-1
 Belt Tension 10-140-1

ENGINE LUBRICATION SYSTEM 10-90-1
 Checking Engine Oil 10-90-1
 Oil Chart. 10-90-1
 Replacing Oil And Filter 10-90-2

FUEL SYSTEM 10-80-1
 Draining The Fuel Tank 10-80-2
 Filling The Fuel Tank 10-80-1
 Fuel Filter. 10-80-3
 Fuel Specifications. 10-80-1
 Removing Air From The Fuel System 10-80-3
 Removing Water From The Fuel Filter. 10-80-2

HEATER AIR FILTER (WITH CAB OPTION ONLY) 10-61-1
 Removal And Installation 10-61-1

HYDRAULIC SYSTEM 10-100-1
 Checking And Adding Hydraulic Oil. 10-100-1
 Diagnostic Couplers. 10-100-3
 Replacing The Case Drain Filter 10-100-3
 Replacing The Hydraulic Filter. 10-100-3
 Replacing The Hydraulic Oil 10-100-2

LIFTING AND BLOCKING THE EXCAVATOR 10-10-1
 Procedure 10-10-1

LIFTING THE EXCAVATOR 10-12-1
 Procedure 10-12-1

LUBRICATION OF THE HYDRAULIC EXCAVATOR 10-110-1

Continued On Next Page

SAFETY AND MAINTENANCE (CONT'D)

OPERATOR CAB (ROPS/TOPS)	10-20-1
Cab Door	10-20-5
Emergency Exit	10-20-1
Front Window	10-20-2
Right Side Windows	10-20-4
RIGHT SIDE COVER	10-41-1
Opening And Closing The Right Side Cover	10-41-1
SEAT BELT	10-150-1
Inspection And Maintenance	10-150-1
SERVICE SCHEDULE	10-50-1
Chart	10-50-1
SPARK ARRESTOR MUFFLER	10-130-1
TAILGATE	10-40-1
Adjusting The Bumper	10-40-1
Adjusting The Latch	10-40-1
Opening And Closing The Tailgate	10-40-1
TRANSPORTING THE EXCAVATOR	10-30-1
Procedure	10-30-1
TRAVEL MOTOR	10-120-1
Checking Oil Level	10-120-1
Draining The Travel Motor	10-120-1
UPPERSTRUCTURE SLEW LOCK	10-11-1
Operation	10-11-1

LIFTING AND BLOCKING THE EXCAVATOR

Procedure

Always park the machine on a level surface.

WARNING

Put jackstands under the blade and rear corners of the undercarriage before working under the machine. Failure to block up the machine may allow it to move or fall and result in injury or death.

W-2218-1195

WARNING

AVOID INJURY

Keep fingers and hands out of pinch points when checking the track tension.

W-2142-0903

Figure 10-10-1



Raise one side of the machine approximately 4 in. (102 mm) using the boom and arm as shown in **[Figure 10-10-1]**.

Raise the blade fully and install jackstands (Item 1) **[Figure 10-10-1]** under the blade and the track frame. Lower the machine until all machine weight is on the jackstands.

Stop the engine.

UPPERSTRUCTURE SLEW LOCK

Operation

Figure 10-11-1

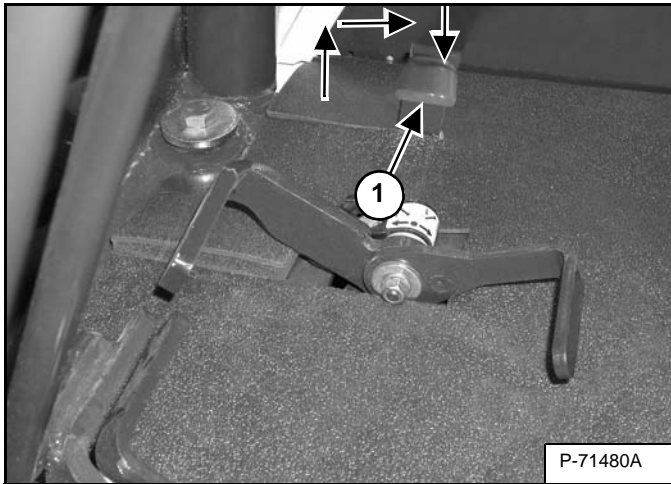

Move the lever (Item 1) [Figure 10-11-1] *up* slightly, then to the rear and down to engage the upperstructure slew lock.

Figure 10-11-2

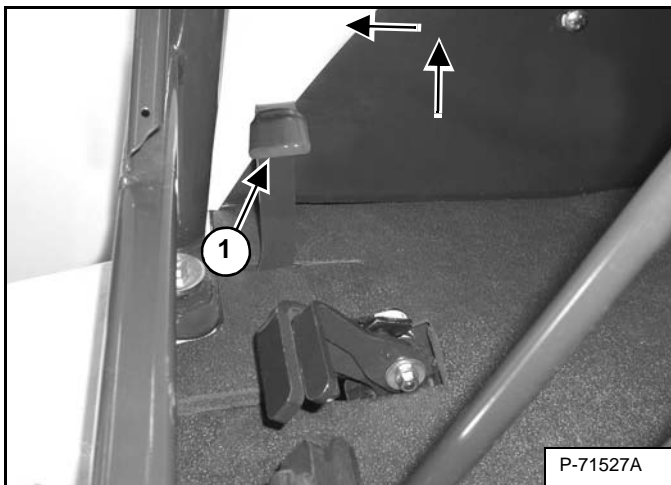

Move the lever (Item 1) [Figure 10-11-2] *up* and then forward to disengage the upperstructure slew lock.

NOTE: Upperstructure must be in the straight forward or straight rearward position for upperstructure to lock.

WARNING

AVOID INJURY

The upperstructure slew lock lever must be engaged when transporting the machine.

W-2197-0904

WARNING

AVOID INJURY OR DEATH

Never use attachments or buckets which are not approved by Bobcat Company. Buckets and attachments for safe loads of specified densities are approved for each model. Unapproved attachments can cause injury or death.

W-2052-0907

LIFTING THE EXCAVATOR

Procedure

Figure 10-12-1

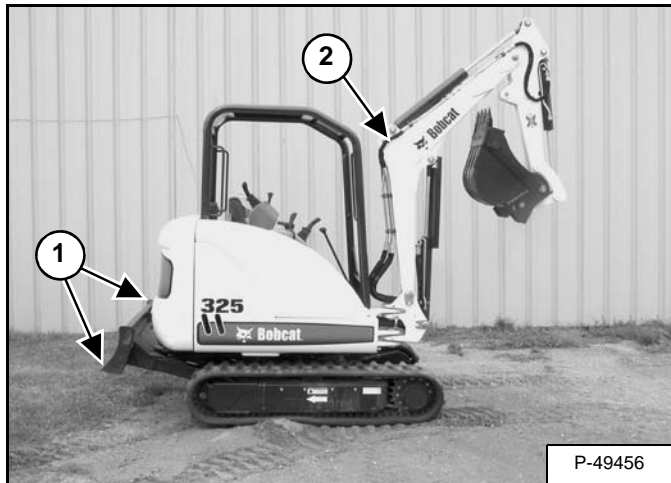

Fully extend the cylinders of the bucket, arm, and boom so that the excavator is in the position as shown [Figure 10-12-1].

Raise the blade all the way.

Put all the control levers in neutral.

WARNING

AVOID INJURY OR DEATH

- Use a lifting fixture with sufficient capacity for the weight of the excavator plus any added attachments.
- Maintain center of gravity and balance when lifting.
- Do not swing boom or upperstructure. Engage the upperstructure slew lock.
- Never lift with operator on machine.

W-2202-0607

Figure 10-12-2

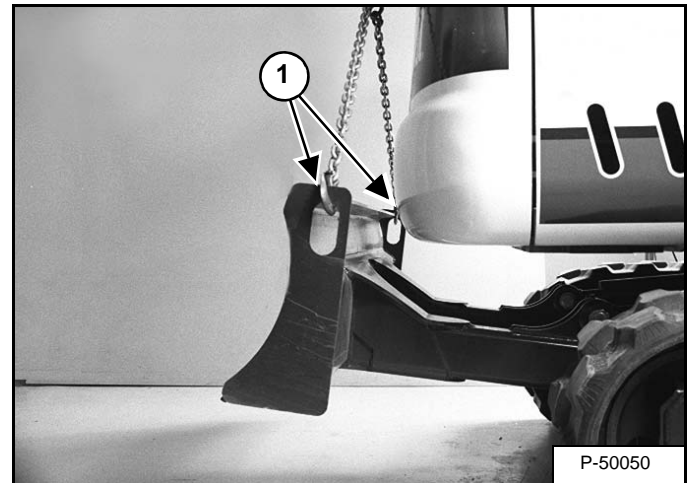

Fasten chains to the ends of the blade (Item 1) [Figure 10-12-1] and [Figure 10-12-2] and up to a lifting fixture above the canopy/cab. The lifting fixture must extend over the sides of the canopy/cab to prevent the chains from hitting the ROPS/TOPS.

Figure 10-12-3

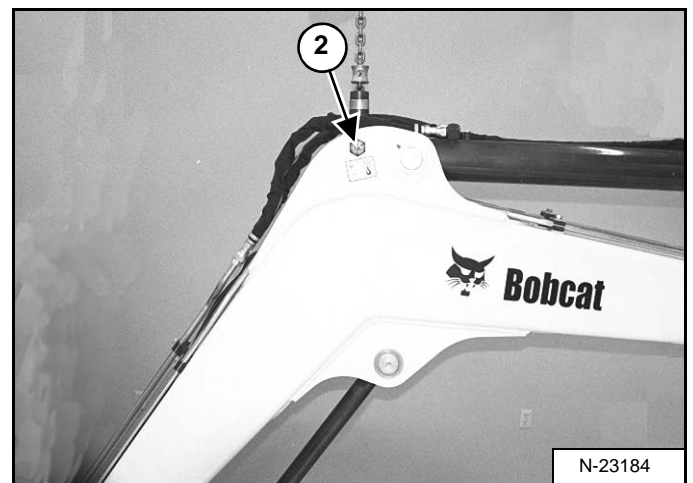

Install a 1 in. (25 mm) bolt and nut (Grade 5 or 8) through the holes in the boom (Item 2) [Figure 10-12-1] and [Figure 10-12-3]. Fasten a chain from the bolt to the lifting fixture.

OPERATOR CAB (ROPS/TOPS)

Emergency Exit

The left door, front window and right rear window provide exits.

Figure 10-20-1

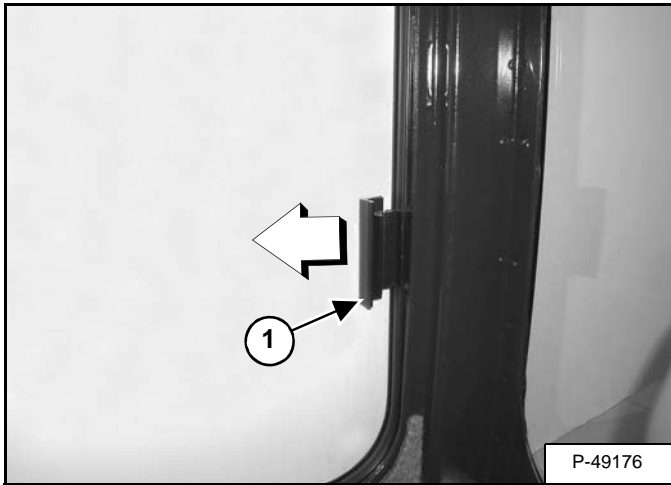

Pull forward on the latch (Item 1) [Figure 10-20-1].

Figure 10-20-2

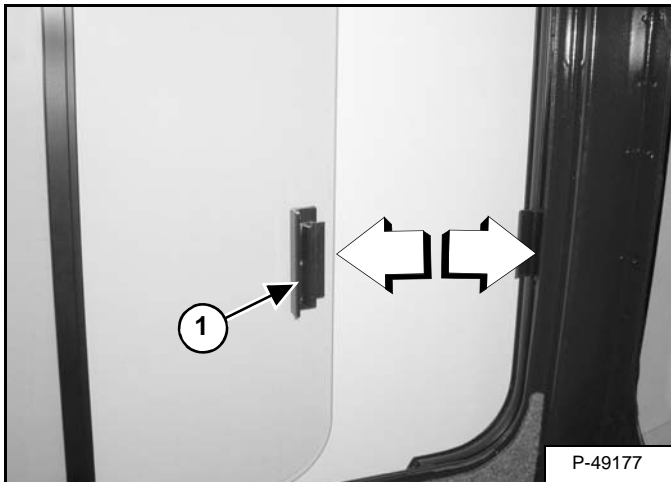

Pull the latch/handle (Item 1) [Figure 10-20-2] forward to open the window.

Push the handle back to close the window.

Figure 10-20-3



Exit through the window [Figure 10-20-3].

Figure 10-20-4



Raise the front window and exit through the window [Figure 10-20-4].

OPERATOR CAB (ROPS/TOPS) (CONT'D)

Front Window

Figure 10-20-5



The front window is equipped with a wiper (Item 1) [Figure 10-20-5] and washer.

Opening The Front Window

Figure 10-20-6

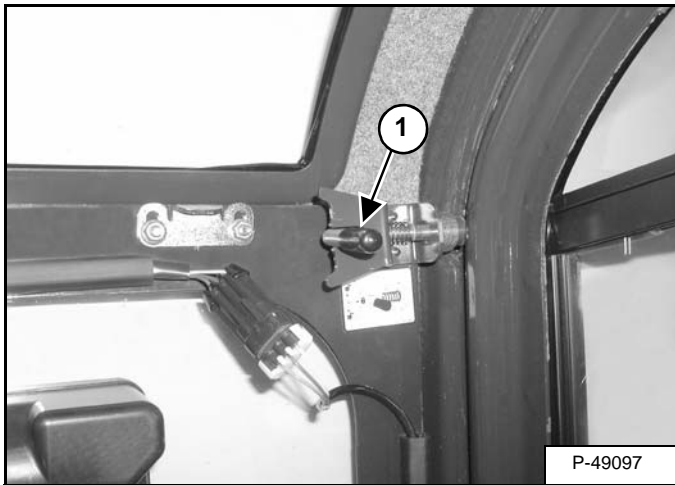

Retract the two top window latch pins (Item 1) [Figure 10-20-6].

Figure 10-20-7

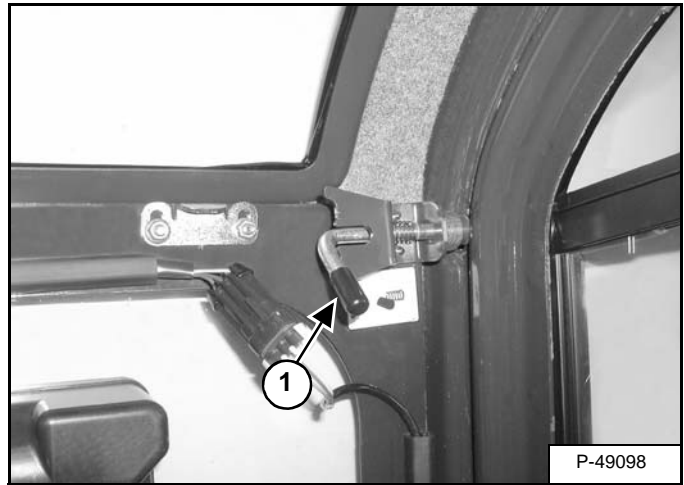

Turn the two top latches (Item 1) [Figure 10-20-7] to the unlocked position.

Figure 10-20-8



Use both window grab handles to pull the top of the window in [Figure 10-20-8].

Continue moving the window in and up over the operator's head until the window is fully raised.

OPERATOR CAB (ROPS/TOPS) (CONT'D)

Front Window (Cont'd)

Figure 10-20-9

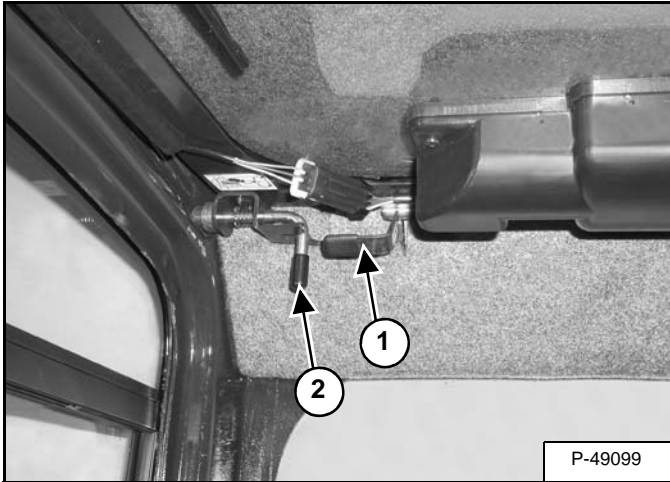

When the window is fully raised, the latch (Item 1) will close on the bracket. Turn the two top latches (Item 2) **[Figure 10-20-9]** to the locked position.

Closing The Front Window

Support the window while releasing both window latch pins and placing the pins in the unlocked position.

Support the window using the left grab handle and pull down on the latch (Item 1) **[Figure 10-20-9]** to release the window.

Use both window grab handles to pull the window down **[Figure 10-20-8 on Page 10-20-2]**.

Rotate the top latches (Item 1) **[Figure 10-20-7 on Page 10-20-2]** to the locked position (Item 1) **[Figure 10-20-6 on Page 10-20-2]**.

OPERATOR CAB (ROPS/TOPS) (CONT'D)

Right Side Windows

Opening the right rear window

Figure 10-20-10

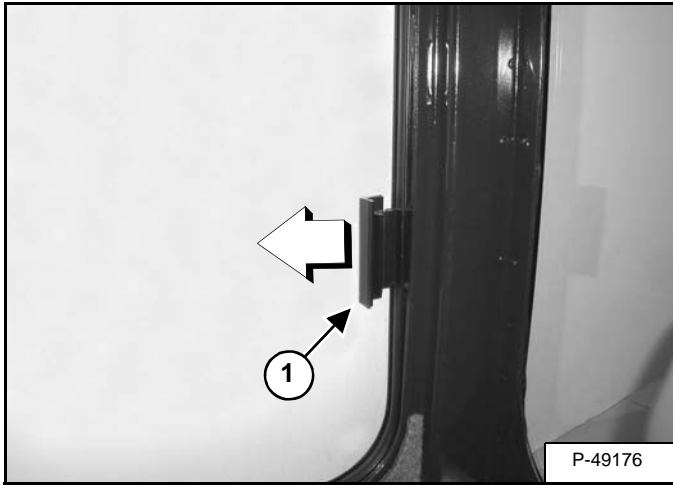

Pull forward on the latch (Item 1) [Figure 10-20-10].

Figure 10-20-11

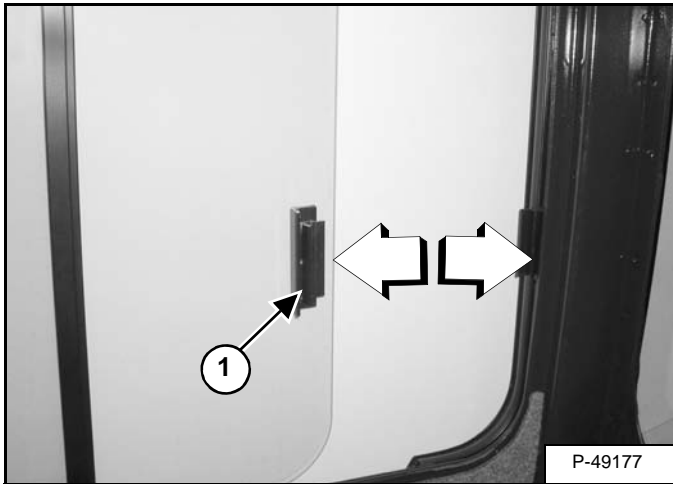

Pull the latch/handle (Item 1) [Figure 10-20-11] forward to open the window.

Push the handle back to close the window.

Opening the right front window

Figure 10-20-12

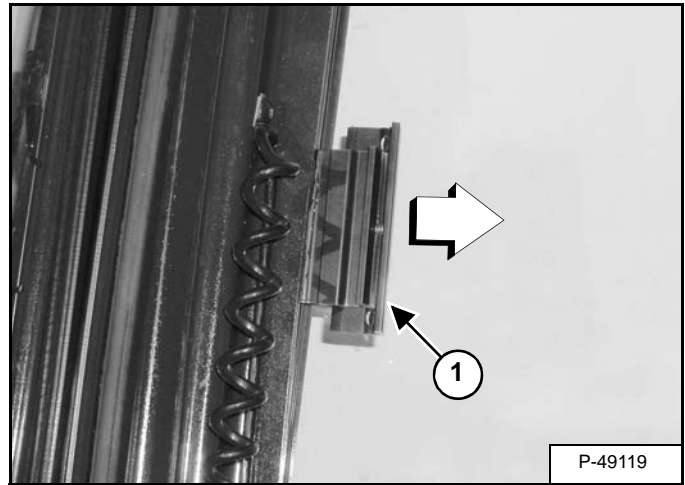

Pull back on the latch (Item 1) [Figure 10-20-12].

Figure 10-20-13

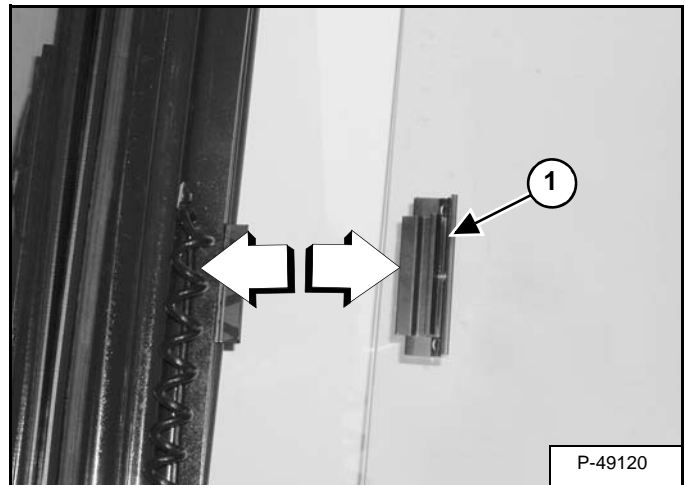

Pull the latch/handle (Item 1) [Figure 10-20-13] back to open the window.

Push the handle forward to close the window.

OPERATOR CAB (ROPS/TOPS) (CONT'D)

Cab Door

Figure 10-20-14

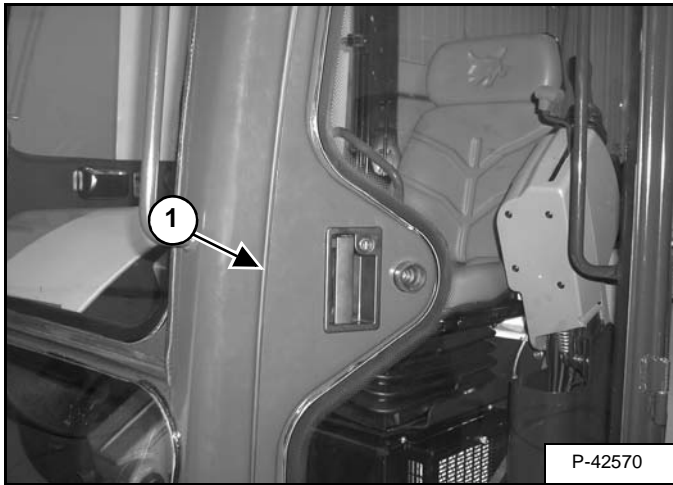

The cab door (Item 1) [Figure 10-20-14] can be locked with the same key as the starter switch (if equipped).

Figure 10-20-15



Push the door all the way open until the latch engages to hold the door in the open position [Figure 10-20-15].

Firmly pull the door away from the cab to disengage the latch and close the door [Figure 10-20-15].

TRANSPORTING THE EXCAVATOR

Procedure

When transporting the machine, observe the rules, motor vehicle laws, and vehicle limit ordinances. Use a transport and towing vehicle of adequate length and capacity.

Secure the parking brakes and block the wheels of the transport vehicle.

Align the ramps with the center of the transport vehicle. Secure the ramps to the truck bed and be sure ramp angle does not exceed 15°.

Use metal loading ramps with a slip resistant surface.

Use ramps that are the correct length and width and can support the weight of the machine.

The rear of the trailer must be blocked or supported when loading or unloading the excavator to prevent the front of the transport vehicle from raising.

Determine the direction of the track movement before moving the machine (blade forward).

Engage the slew lock.

Figure 10-30-1



Move the machine forward onto the transport vehicle [Figure 10-30-1].

Do not change direction of the machine while it is on the ramps.

Lower the boom, arm, bucket, and blade to the transport vehicle.

Stop the engine and remove the key (if equipped).

Put blocks at the front and rear of the tracks.

Figure 10-30-2

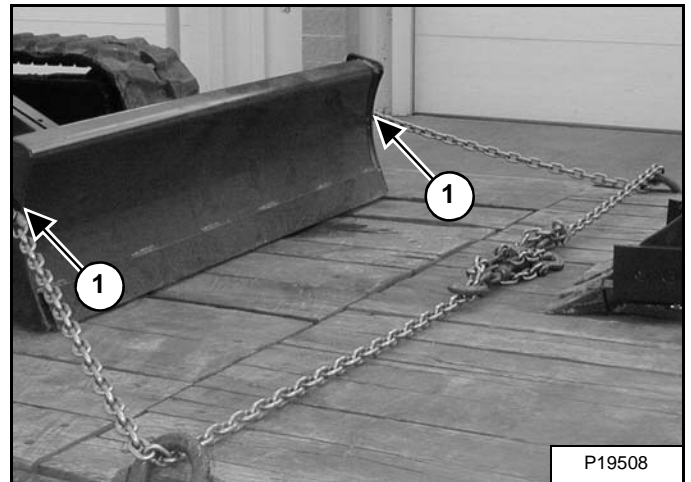
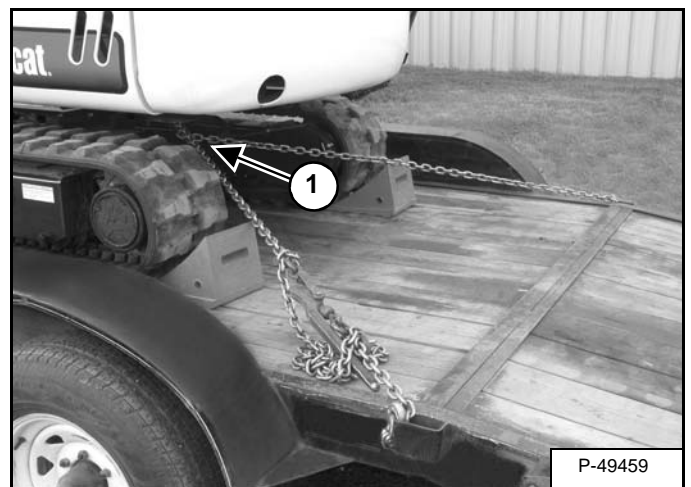

Figure 10-30-3



Fasten chains to the front corners of the blade (Item 1) [Figure 10-30-2] and to the tie down loop at the rear of the track frame (Item 1) [Figure 10-30-3] to prevent it from moving when going up or down slopes or during sudden stops.

Use chain binders to tighten the chains and then safely tie the chain binder levers to prevent loosening.

! WARNING

AVOID SERIOUS INJURY OR DEATH
Adequately designed ramps of sufficient strength are needed to support the weight of the machine when loading onto a transport vehicle. Wood ramps can break and cause personal injury.

W-2058-0807

TAILGATE

Opening And Closing The Tailgate

! WARNING

AVOID INJURY OR DEATH

Never service or adjust the machine when the engine is running unless instructed to do so in the manual.

W-2012-0497

! WARNING

Keep the rear door closed when operating the machine. Failure to do so could seriously injure a bystander.

W-2020-1285

Figure PM-1

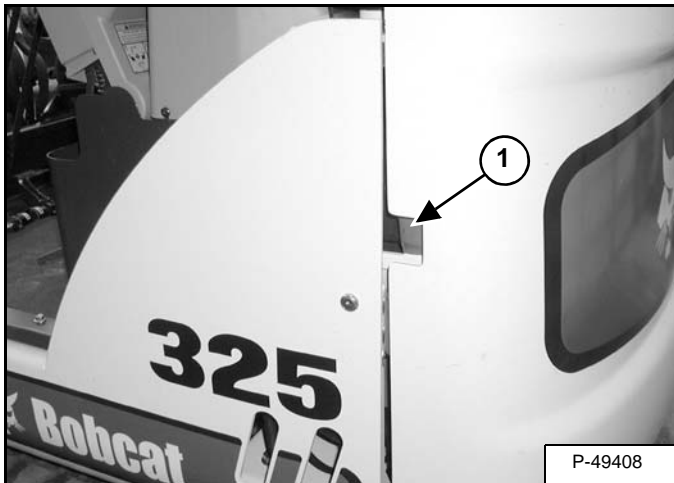

Pull the latch (Item 1) [Figure PM-1] and pull the tailgate open.

Push firmly to close the tailgate.

NOTE: The tailgate can be locked using the start key.

Adjusting The Bumper

Figure 10-40-2

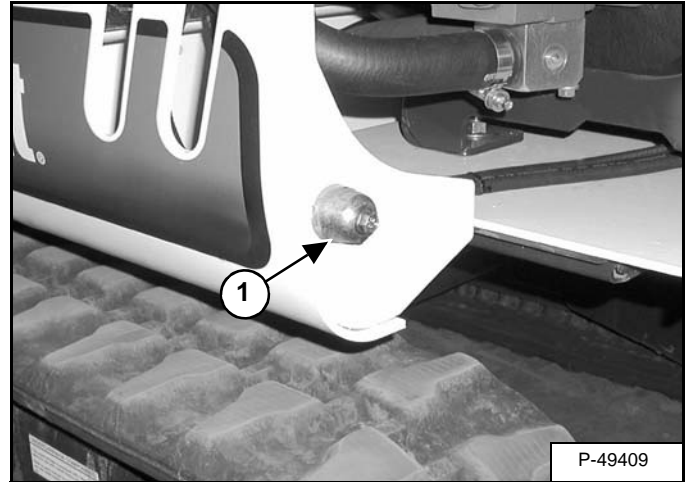

The door bumper (Item 1) [Figure 10-40-2] can be adjusted for alignment with the tailgate.

Close the tailgate before operating the excavator.

Adjusting The Latch

Figure 10-40-3

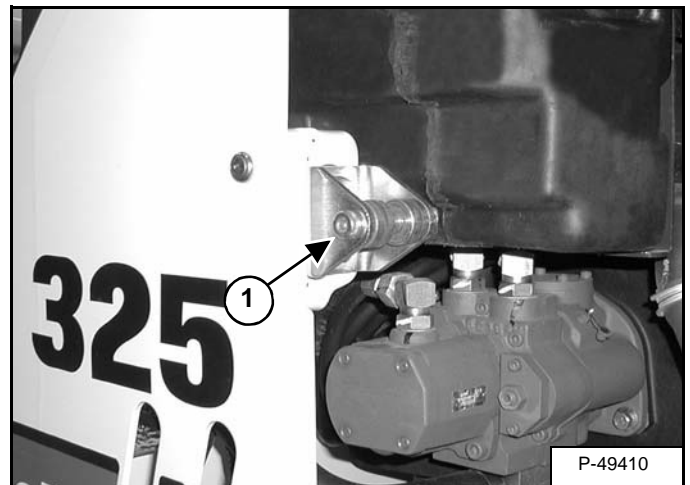

The door catch (Item 1) [Figure 10-40-3] can be adjusted for alignment.

Close the tailgate before operating the excavator.

RIGHT SIDE COVER

Opening And Closing The Right Side Cover

Figure 10-41-1

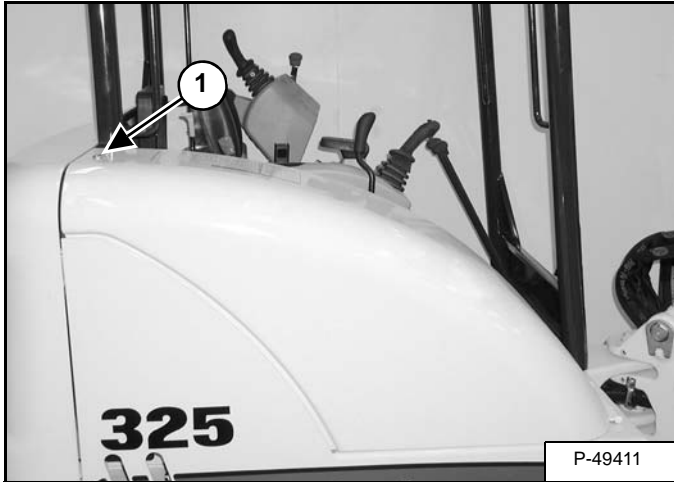

Pull the latch (Item 1) **[Figure 10-41-1]** and raise the right side cover.

NOTE: The right side cover can be locked using the start key.



Suggest:

If the above button click is invalid.

Please download this document

first, and then click the above link

to download the complete manual.

Thank you so much for reading

SERVICE SCHEDULE

Chart

Maintenance work must be done at regular intervals. Failure to do so will result in excessive wear and early failures. The service schedule is a guide for correct maintenance of the Bobcat Excavator.



AVOID INJURY OR DEATH

Instructions are necessary before operating or servicing machine. Read and understand the Operation & Maintenance Manual, Operator's Handbook and signs (decals) on machine. Follow warnings and instructions in the manuals when making repairs, adjustments or servicing. Check for correct function after adjustments, repairs or service. Untrained operators and failure to follow instructions can cause injury or death.

W-2003-0807

SERVICE SCHEDULE		HOURS						
ITEM	SERVICE REQUIRED	8-10	50	100	250	500	1000	
Engine Coolant	Check coolant level. Add premixed coolant as needed.							
Engine Oil	Check the engine oil level and add as needed.							
Hydraulic Fluid, Hoses and Tubelines, Reservoir Breather Cap	Check the hydraulic fluid level and add as needed. Check for damage and leaks. Repair or replace as needed.							
Engine Air Filter and Air System	Check condition indicator and empty dust cup as needed. Check air system for leaks.							
Tracks	Check and adjust track tension as needed.							
Indicators and Lights	Check for correct operation of all indicators and lights.							
Operator Canopy/Cab	Check condition. Check mounting hardware.							
Seat Belt	Check condition. Check mounting hardware.							
Safety Signs and Safety Treads	Check for damaged signs (decals) and safety treads. Replace any signs or safety treads that are damaged or worn.							
Pivot Points	Grease all machinery pivot points.							
Cab Heater Air Filter	Clean the filter as needed.							
Console Lockout	Check console lockout for proper operation.							
X-Change™	Lubricate and inspect for damage or loose parts.							
Slew Circle and Pinion	Grease two fittings							
Fuel Tank & Filter	Drain water and sediment from fuel tank and fuel filter.							
Battery	Check battery, cables, connections and electrolyte level. Add distilled water as needed.							
Accessory Drive Belt	Check condition of belt and adjust as needed.							
Spark Arrestor Muffler	Clean the spark chamber.							
Travel Motor	Check the oil level in both travel motors							
Fuel Filter	Replace fuel filter.							
Radiator, Oil Cooler	Clean debris from the radiator fins.							
Engine Oil and Filter	Replace oil and filter. Use CD or better grade oil and Bobcat filter.							
Primary Hydraulic Filter and Reservoir Breather	Replace the primary hydraulic filter and reservoir breather.			^				
Case Drain Filter	Replace the case drain filter.			^				
Alternator & Starter	Check the alternator and starter connections.			^				
Engine Valves	Check and adjust the engine valve clearance.							
Hydraulic System	Replace the hydraulic fluid and filters.							
Travel Motor	Replace the lubricant in both travel motors.			†				
Engine Cooling System	Drain and flush the cooling system. Replace the coolant.							

* Check after the first 50 hours, then 100 hour intervals thereafter.

** First oil and filter change must occur at 50 hours; then 250 hour intervals thereafter

^ Check after the first 100 hours, then 500 hour intervals thereafter.

† Check after the first 100 hours, then 1000 hour intervals thereafter.

■ Or every 12 months.

<https://www.ebooklibonline.com>

Hello dear friend!

Thank you very much for reading.

Enter the link into your browser.

The full manual is available for immediate download.

<https://www.ebooklibonline.com>