



# Bobcat®

---

## Service Manual

# S530 Skid-Steer Loader

---

S/N A7TW11001 & Above  
S/N AZN711001 & Above  
S/N ATZD11001 & Above  
S/N AZN611001 & Above

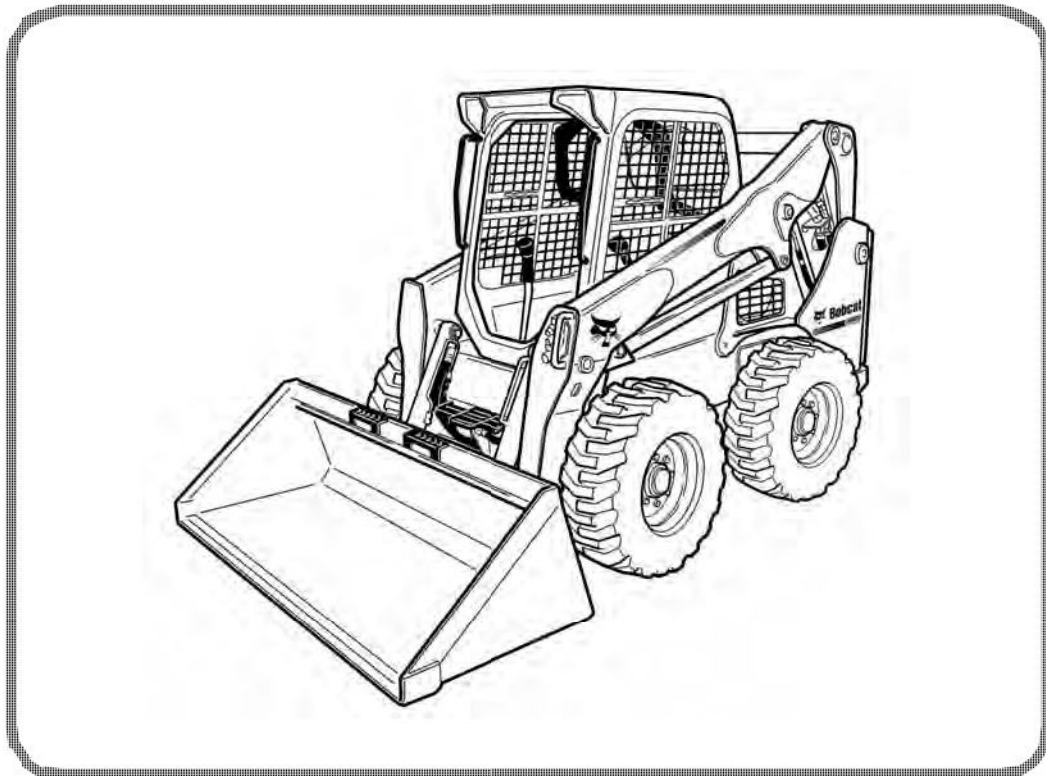

Dealer Copy -- Not for Resale

EQUIPPED WITH  
BOBCAT INTERLOCK  
CONTROL SYSTEM (BICS™)



# MAINTENANCE SAFETY



## WARNING

Instructions are necessary before operating or servicing machine. Read and understand the Operation & Maintenance Manual, Operator's Handbook and signs (decals) on machine. Follow warnings and instructions in the manuals when making repairs, adjustments or servicing. Check for correct function after adjustments, repairs or service. Untrained operators and failure to follow instructions can cause injury or death.

W-2003-0807



**Safety Alert Symbol:** This symbol with a warning statement, means: "Warning, be alert! Your safety is involved!" Carefully read the message that follows.

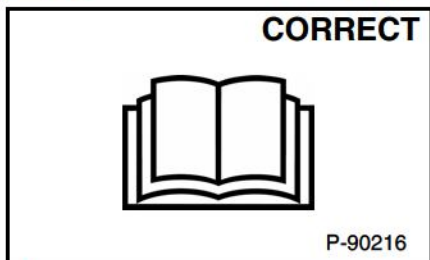

P-90216

⚠ Never service the Bobcat Skid-Steer Loader without instructions.

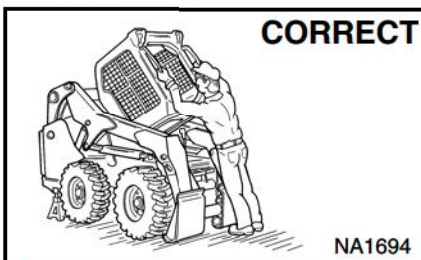

NA1694

⚠ Use the correct procedure to lift or lower operator cab.

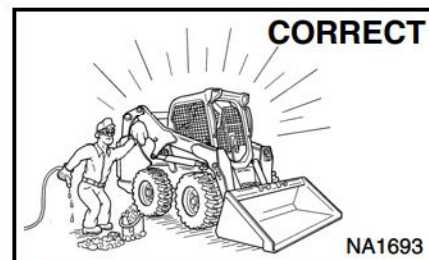

NA1693

⚠ Cleaning and maintenance are required daily.

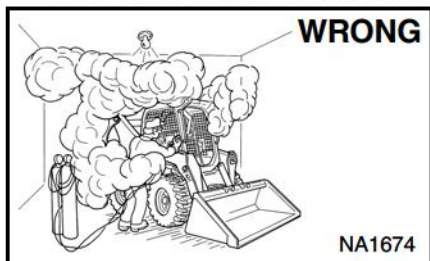

NA1674

- ⚠ Have good ventilation when welding or grinding painted parts.
- ⚠ Wear dust mask when grinding painted parts. Toxic dust and gas can be produced.
- ⚠ Avoid exhaust fume leaks which can kill without warning. Exhaust system must be tightly sealed.

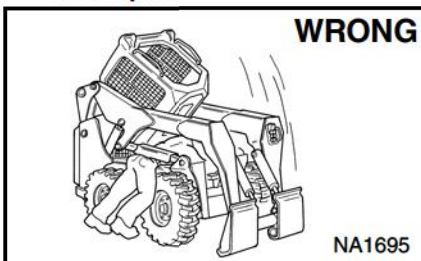

NA1695

⚠ Disconnecting or loosening any hydraulic tubeline, hose, fitting, component or a part failure can cause lift arms to drop. Do not go under lift arms when raised unless supported by an approved lift arm support device. Replace it if damaged.

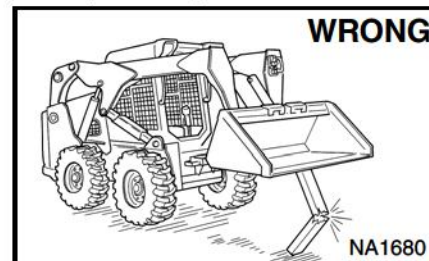

NA1680

- ⚠ Never work on loader with lift arms up unless lift arms are held by an approved lift arm support device. Replace if damaged.
- ⚠ Never modify equipment or add attachments not approved by Bobcat Company.



NA1682

- ⚠ Stop, cool and clean engine of flammable materials before checking fluids.
- ⚠ Never service or adjust loader with the engine running unless instructed to do so in the manual.
- ⚠ Avoid contact with leaking hydraulic fluid or diesel fuel under pressure. It can penetrate the skin or eyes.
- ⚠ Never fill fuel tank with engine running, while smoking or when near open flame.

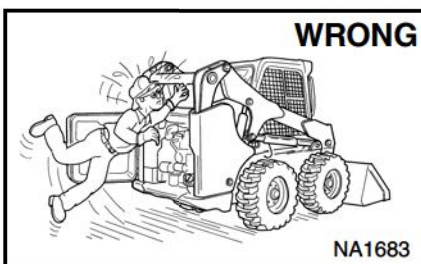

NA1683

- ⚠ Keep body, jewelry and clothing away from moving parts, electrical contact, hot parts and exhaust.
- ⚠ Wear eye protection to guard from battery acid, compressed springs, fluids under pressure and flying debris when engines are running or tools are used. Use eye protection approved for type of welding.
- ⚠ Keep rear door closed except for service. Close and latch door before operating the loader.



B-6589

- ⚠ Lead-acid batteries produce flammable and explosive gases.
- ⚠ Keep arcs, sparks, flames and lighted tobacco away from batteries.
- ⚠ Batteries contain acid which burns eyes or skin on contact.
- ⚠ Wear protective clothing. If acid contacts body, flush well with water. For eye contact flush well and get immediate medical attention.

Maintenance procedures which are given in the Operation & Maintenance Manual can be performed by the owner/operator without any specific technical training. Maintenance procedures which are **not** in the Operation & Maintenance Manual must be performed **ONLY BY QUALIFIED BOBCAT SERVICE PERSONNEL**. Always use genuine Bobcat replacement parts. The Service Safety Training Course is available from your Bobcat dealer.

MSW39-0609

Dealer Copy -- Not for Resale

## CONTENTS

SAFETY AND MAINTENANCE .....	10-01
HYDRAULIC SYSTEM .....	20-01
HYDROSTATIC SYSTEM .....	30-01
DRIVE SYSTEM .....	40-01
MAINFRAME .....	50-01
ELECTRICAL SYSTEM AND ANALYSIS .....	60-01
ENGINE SERVICE .....	70-01
HEATING AND VENTILATION .....	80-01
SPECIFICATIONS .....	SPEC-01
ALPHABETICAL INDEX .....	INDEX-01

Dealer Copy -- Not for Resale

## FOREWORD

FOREWORD .....	1-7
SAFETY INSTRUCTIONS .....	1-9
FIRE PREVENTION .....	1-11
Maintenance .....	1-11
Operation .....	1-11
Electrical .....	1-11
Hydraulic System .....	1-11
Fueling .....	1-11
Starting .....	1-11
Spark Arrester Exhaust System .....	1-11
Welding And Grinding .....	1-12
Fire Extinguishers .....	1-12
SERIAL NUMBER LOCATIONS .....	1-13
Loader Serial Number .....	1-13
Engine Serial Number .....	1-13
DELIVERY REPORT .....	1-14
LOADER IDENTIFICATION .....	1-15

Dealer Copy -- Not for Resale

**<https://www.ebooklibonline.com>**

Hello dear friend!

Thank you very much for reading.

Enter the link into your browser.

The full manual is available for immediate download.

**<https://www.ebooklibonline.com>**

# FOREWORD

This manual is for the Bobcat loader mechanic. It provides necessary servicing and adjustment procedures for the Bobcat loader and its component parts and systems. Refer to the Operation & Maintenance Manual for operating instructions, starting procedure, daily checks, etc.

A general inspection of the following items must be made after the loader has had service or repair:

1. Check that the ROPS/FOPS (Including side screens) is in good condition and is not modified.

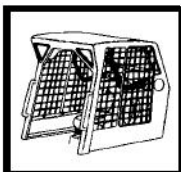

2. Check that ROPS mounting hardware is tightened and is Bobcat approved.



3. The seat belt must be correctly installed, functional and in good condition.



4. The seat bar must be correctly adjusted, clean and lubricated.

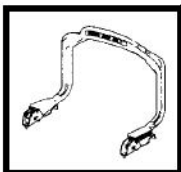

5. Check lift arm support device, replace if damaged.



6. Machine signs (decals) must be legible and in the correct location.



7. Steering levers, hand controls and foot pedals must return to neutral (as applicable).

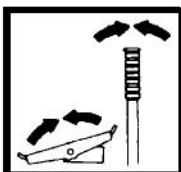

8. Check for correct function of the work lights.



9. The parking brake must function correctly.



10. Enclosure door latches must open and close freely.

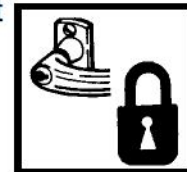

11. Bob-Tach wedges and linkages must function correctly and be in good condition.

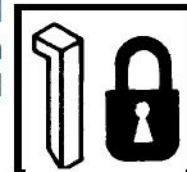

12. Safety treads must be in good condition.



13. Check for correct function of indicator lamps.

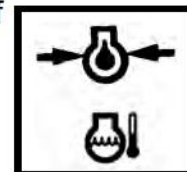

14. Check hydraulic fluid level, engine oil level and fuel supply.



15. Inspect for fuel, oil or hydraulic fluid leaks.

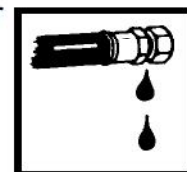

16. Lubricate the loader.



Dealer Copy -- Not for Resale

FW SSL-1008 SM

17. Check the condition of the battery and cables.

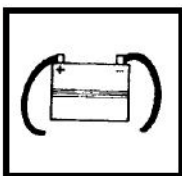

18. Inspect the air cleaner for damage or leaks. Check the condition of the element.



19. Check the electrical charging system.

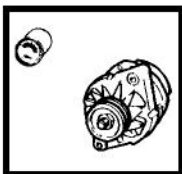

20. Check tires for wear and pressure. Check tires for wear and tension. Use only approved tires or tires.



21. Inspect for loose or broken parts or connections.



22. Check for any field modification not completed.



23. Operate the machine and check all functions.



24. Check for correct function of the Bobcat Interlock Control System (BICS™) before the machine is returned to the customer.



25. Check for proper function of front horn and back-up alarm (if equipped).

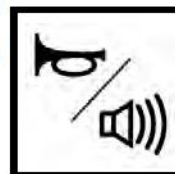

26. Check function or condition of all equipped options and accessories (examples: fire extinguisher, rotating beacon, lift kits, etc.).



27. Recommend to the owner that all necessary corrections be made before the machine is returned to service.

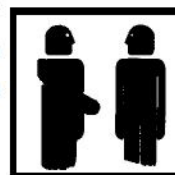

**CALIFORNIA  
PROPOSITION 65 WARNING**  
Diesel engine exhaust and some of its constituents are known to the state of California to cause cancer, birth defects and other reproductive harm.

## SAFETY INSTRUCTIONS

 <b>Safety Alert Symbol</b>
<b>This symbol with a warning statement means: “Warning, be alert! Your safety is involved!” Carefully read the message that follows.</b>



### AVOID INJURY OR DEATH

Instructions are necessary before operating or servicing machine. Read and understand the Operation & Maintenance Manual, Operator's Handbook and signs (decals) on machine. Follow warnings and instructions in the manuals when making repairs, adjustments or servicing. Check for correct function after adjustments, repairs or service. Untrained operators and failure to follow instructions can cause injury or death.

W-2003-0807



This notice identifies procedures which must be followed to avoid damage to the machine.

I-2019-0284



The signal word DANGER on the machine and in the manuals indicates a hazardous situation which, if not avoided, will result in death or serious injury.

D-1002-1107



The signal word WARNING on the machine and in the manuals indicates a potentially hazardous situation which, if not avoided, could result in death or serious injury.

W-2044-1107

The following publications provide information on the safe use and maintenance of the Bobcat machine and attachments:

- The Delivery Report is used to assure that complete instructions have been given to the new owner and that the machine is in safe operating condition.
- The Operation & Maintenance Manual delivered with the machine or attachment contains operating information as well as routine maintenance and service procedures. It is a part of the machine and can be stored in a container provided on the machine. Replacement Operation & Maintenance Manuals can be ordered from your Bobcat dealer.
- Machine signs (decals) instruct on the safe operation and care of your Bobcat machine or attachment. The signs and their locations are shown in the Operation & Maintenance Manual. Replacement signs are available from your Bobcat dealer.
- An Operator's Handbook fastened to the operator cab. It's brief instructions are convenient to the operator. The handbook is available from your dealer in an English edition or one of many other languages. See your Bobcat dealer for more information on translated versions.
- The AEM Safety Manual delivered with the machine gives general safety information.
- The Service Manual and Parts Manual are available from your dealer for use by mechanics to do shop-type service and repair work.
- The Skid-Steer Loader Operator Training Course is available through your local dealer or at [www.training.bobcat.com](http://www.training.bobcat.com) or [www.bobcat.com](http://www.bobcat.com). This course is intended to provide rules and practices of correct operation of the skid-steer loader. The course is available in English and Spanish versions.
- Service Safety Training Courses are available from your Bobcat dealer or at [www.training.bobcat.com](http://www.training.bobcat.com) or [www.bobcat.com](http://www.bobcat.com). They provide information for safe and correct service procedures.
- The Skid-Steer Loader Safety Video is available from your Bobcat dealer or at [www.training.bobcat.com](http://www.training.bobcat.com) or [www.bobcat.com](http://www.bobcat.com).

Dealer Copy -- Not for Resale

SI SSL-0511 SM

## FIRE PREVENTION



### Maintenance

The machine and some attachments have components that are at high temperatures under normal operating conditions. The primary source of high temperatures is the engine and exhaust system. The electrical system, if damaged or incorrectly maintained, can be a source of arcs or sparks.

Flammable debris (leaves, straw, etc.) must be removed regularly. If flammable debris is allowed to accumulate, it can cause a fire hazard. Clean often to avoid this accumulation. Flammable debris in the engine compartment is a potential fire hazard.

The operator's area, engine compartment and engine cooling system must be inspected every day and cleaned if necessary to prevent fire hazards and overheating.

All fuels, most lubricants and some coolants mixtures are flammable. Flammable fluids that are leaking or spilled onto hot surfaces or onto electrical components can cause a fire.

### Operation

Do not use the machine where exhaust, arcs, sparks or hot components can contact flammable material, explosive dust or gases.

### Electrical



Check all electrical wiring and connections for damage. Keep the battery terminals clean and tight. Repair or replace any damaged part or wires that are loose or frayed.

Battery gas can explode and cause serious injury. Use the procedure in the Operation & Maintenance Manual for connecting the battery and for jump starting. Do not jump start or charge a frozen or damaged battery. Keep any open flames or sparks away from batteries. Do not smoke in battery charging area.

## Hydraulic System

Check hydraulic tubes, hoses and fittings for damage and leakage. Never use open flame or bare skin to check for leaks. Hydraulic tubes and hoses must be properly routed and have adequate support and secure clamps. Tighten or replace any parts that show leakage.

Always clean fluid spills. Do not use gasoline or diesel fuel for cleaning parts. Use commercial nonflammable solvents.

### Fueling



Stop the engine and let it cool before adding fuel. No smoking! Do not refuel a machine near open flames or sparks. Fill the fuel tank outdoors.

### Starting

Do not use ether or starting fluids on any engine that has glow plugs or air intake heater. These starting aids can cause explosion and injure you or bystanders.

Use the procedure in the Operation & Maintenance Manual for connecting the battery and for jump starting.

## Spark Arrester Exhaust System

The spark arrester exhaust system is designed to control the emission of hot particles from the engine and exhaust system, but the muffler and the exhaust gases are still hot.

Check the spark arrester exhaust system regularly to make sure it is maintained and working properly. Use the procedure in the Operation & Maintenance Manual for cleaning the spark arrester muffler (if equipped).

Dealer Copy - Not for Resale

## FIRE PREVENTION (CONT'D)

### Welding And Grinding

Always clean the machine and attachment, disconnect the battery, and disconnect the wiring from the Bobcat controllers before welding. Cover rubber hoses, battery and all other flammable parts. Keep a fire extinguisher near the machine when welding.

Have good ventilation when grinding or welding painted parts. Wear dust mask when grinding painted parts. Toxic dust or gas can be produced.

Dust generated from repairing nonmetallic parts such as hoods, fenders or covers can be flammable or explosive. Repair such components in a well ventilated area away from open flames or sparks.

### Fire Extinguishers



Know where fire extinguishers and first aid kits are located and how to use them. Inspect the fire extinguisher and service the fire extinguisher regularly. Obey the recommendations on the instructions plate.

## SERIAL NUMBER LOCATIONS

Always use the serial number of the loader when requesting service information or when ordering parts. Early or later models (identification made by serial number) may use different parts, or it may be necessary to use a different procedure in doing a specific service operation.

### Loader Serial Number

Figure 1

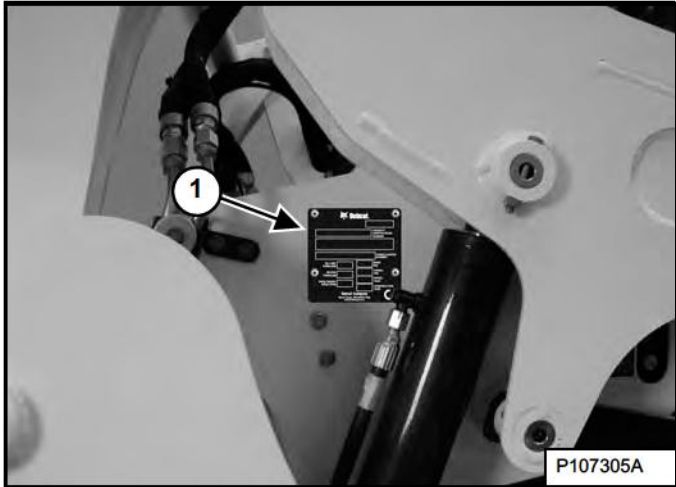

The loader serial number plate (Item 1) [Figure 1] is located on the outside of the loader frame.

Figure 2

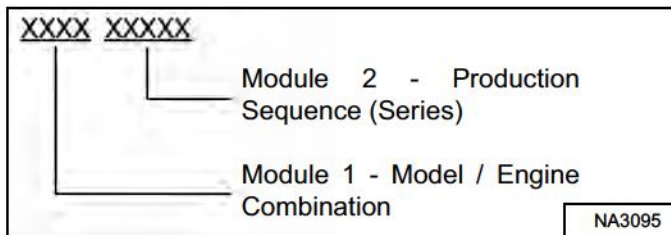

Explanation of loader Serial Number [Figure 2]:

1. The four digit Model / Engine Combination Module number identifies the model number and engine combination.
2. The five digit Production Sequence Number identifies the order which the loader is produced.

### Engine Serial Number

Figure 3

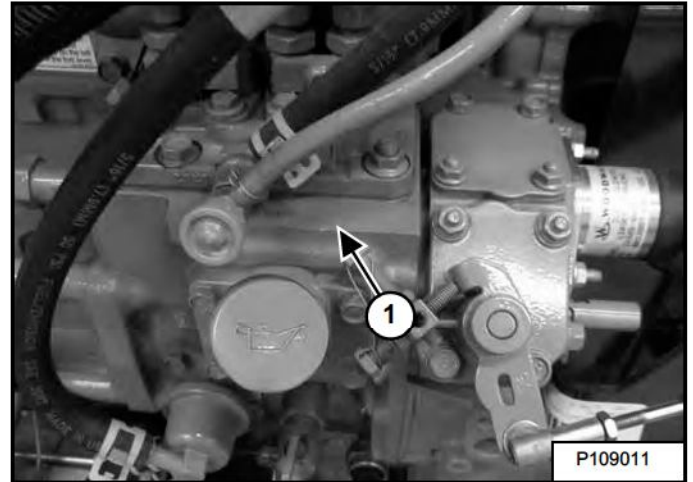

The engine serial number (Item 1) is located above the oil fill cap.

# DELIVERY REPORT

Figure 4

**Bobcat** Delivery Report Loader

Dealer Number: \_\_\_\_\_ Dealer Name: \_\_\_\_\_

NA3106 (Print Dealer Name)

**WARNING**

1. Read and understand the Operator's Manual before operating the loader. 2. Read the safety instructions on the loader. 3. Read the safety instructions on the attachments. 4. Read the safety instructions on the PTO. 5. Read the safety instructions on the lift arms. 6. Read the safety instructions on the backhoe. 7. Read the safety instructions on the backhoe loader. 8. Read the safety instructions on the backhoe loader with backhoe attachment. 9. Read the safety instructions on the backhoe loader with backhoe attachment and backhoe loader. 10. Read the safety instructions on the backhoe loader with backhoe attachment and backhoe loader. 11. Read the safety instructions on the backhoe loader with backhoe attachment and backhoe loader. 12. Read the safety instructions on the backhoe loader with backhoe attachment and backhoe loader. 13. Read the safety instructions on the backhoe loader with backhoe attachment and backhoe loader. 14. Read the safety instructions on the backhoe loader with backhoe attachment and backhoe loader. 15. Read the safety instructions on the backhoe loader with backhoe attachment and backhoe loader. 16. Read the safety instructions on the backhoe loader with backhoe attachment and backhoe loader. 17. Read the safety instructions on the backhoe loader with backhoe attachment and backhoe loader. 18. Read the safety instructions on the backhoe loader with backhoe attachment and backhoe loader. 19. Read the safety instructions on the backhoe loader with backhoe attachment and backhoe loader. 20. Read the safety instructions on the backhoe loader with backhoe attachment and backhoe loader.

Dealer Representative Signature: \_\_\_\_\_ Date: \_\_\_\_\_

Owner/Operator Signature: \_\_\_\_\_ Date: \_\_\_\_\_

NA3106

The delivery report [Figure 4] must be completed by the dealer and signed by the owner or operator when the Bobcat loader is delivered. An explanation of the form must be given to the owner.

## LOADER IDENTIFICATION

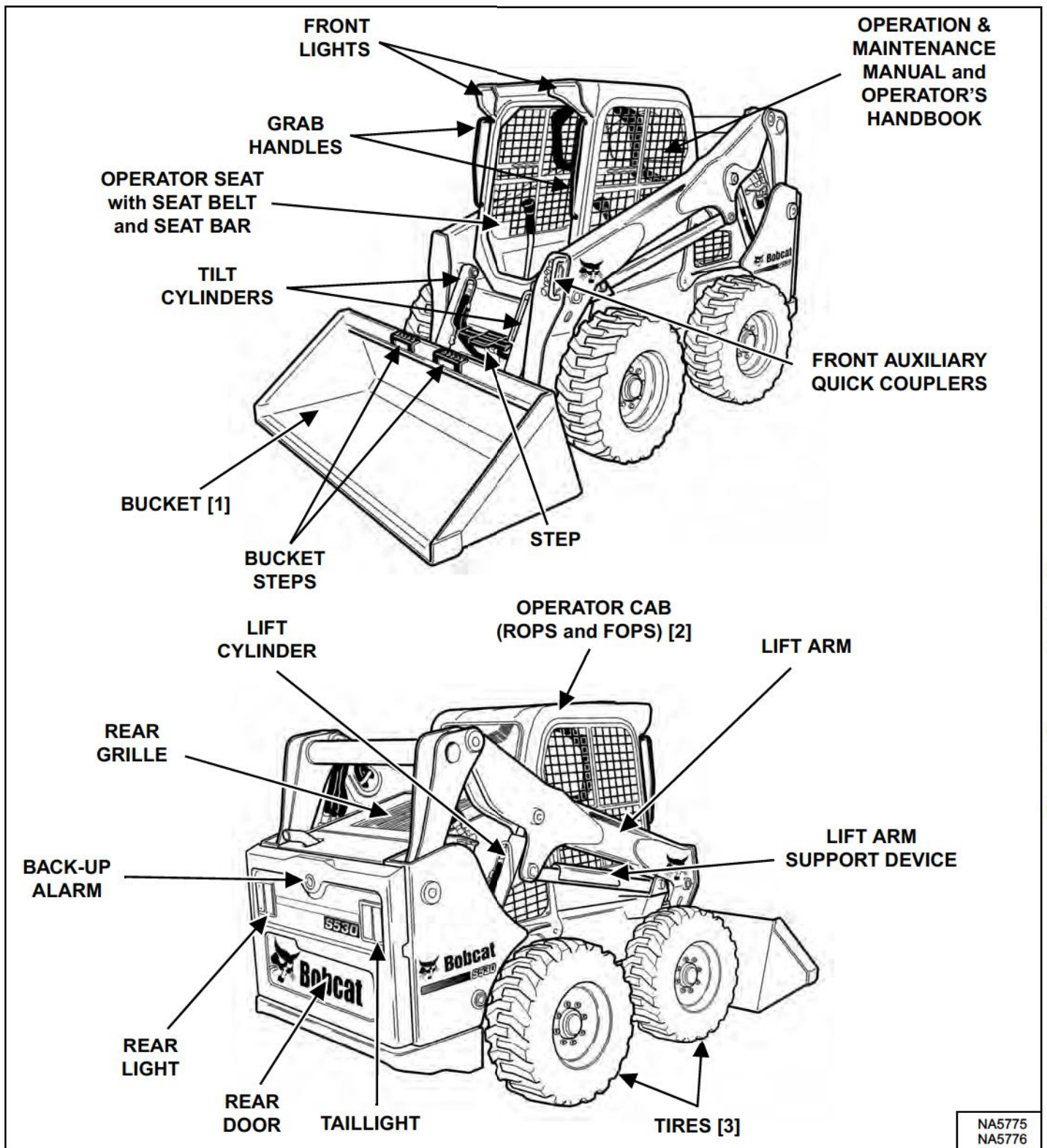

- [1] BUCKETS - Several different buckets and other attachments are available for the Bobcat loader.
- [2] ROPS - Roll-Over Protective Structure per ISO 3471 and FOPS - Falling-Object Protective Structure per ISO 3449, Level I. Level II is available.
- [3] TIRES - Standard tires are shown. Several different tire styles and sizes are available for the Bobcat loader.

Dealer Copy -- Not for Resale

NA5775  
NA5776

## SAFETY AND MAINTENANCE

LIFTING AND BLOCKING THE LOADER .....	10-10-1
Procedure .....	10-10-1
LIFT ARM SUPPORT DEVICE .....	10-20-1
Description .....	10-20-1
Installing .....	10-20-2
Removing .....	10-20-3
OPERATOR CAB .....	10-30-1
Description .....	10-30-1
Raising .....	10-30-2
Lowering .....	10-30-3
Cab Door Sensor .....	10-30-4
Special Applications Kit .....	10-30-4
Special Applications Kit Inspection And Maintenance .....	10-30-4
Forestry Door And Window Kit .....	10-30-5
Forestry Door And Window Kit Inspection And Maintenance .....	10-30-5
TRANSPORTING THE LOADER ON A TRAILER .....	10-40-1
Loading And Unloading .....	10-40-1
Fastening .....	10-40-1
TOWING THE LOADER .....	10-50-1
Procedure .....	10-50-1
REMOTE START TOOL KIT- MEL1563 .....	10-60-1
Remote Start Tool - MEL1563 .....	10-60-1
Service Tool Harness Communicator - MEL1566 .....	10-60-3
Remote Start Procedure .....	10-60-3
REMOTE START TOOL (SERVICE TOOL) KIT - 7217666 .....	10-61-1
Description .....	10-61-1
Remote Start Tool (Service Tool) - 7022042 .....	10-61-2
Loader Service Tool Harness - 6689747 .....	10-61-3
Computer Service Tool Harness - 6689746 .....	10-61-4
Remote Start Procedure .....	10-61-5
SERVICE SCHEDULE .....	10-70-1
Maintenance Intervals .....	10-70-1
ENGINE AIR CLEANER .....	10-80-1
Replacing Filters .....	10-80-1
ENGINE COOLING SYSTEM .....	10-90-1
Maintenance Platform .....	10-90-1
Cleaning .....	10-90-2
Checking And Adding Coolant .....	10-90-3
Removing And Replacing Coolant .....	10-90-4

Dealer Copy -- Not for Resale

FUEL SYSTEM .....	10-100-1
Fuel Specifications .....	10-100-1
Biodiesel Blend Fuel .....	10-100-1
Filling The Fuel Tank .....	10-100-2
Fuel Filter .....	10-100-3
Removing Air From The Fuel System .....	10-100-4
ENGINE LUBRICATION SYSTEM .....	10-110-1
Checking And Adding Engine Oil .....	10-110-1
Engine Oil Chart .....	10-110-1
Removing And Replacing Oil And Filter .....	10-110-2
HYDRAULIC / HYDROSTATIC SYSTEM .....	10-120-1
Checking And Adding Fluid .....	10-120-1
Hydraulic / Hydrostatic Fluid Chart .....	10-120-1
Removing And Replacing Hydraulic Fluid .....	10-120-2
Removing And Replacing Hydraulic / Hydrostatic Filter .....	10-120-4
Removing And Replacing Hydraulic Charge Filter .....	10-120-5
Replacing Reservoir Breather Cap .....	10-120-6
FINAL DRIVE TRANSMISSION (CHAINCASE) .....	10-130-1
Checking And Adding Fluid .....	10-130-1
Removing And Replacing Fluid .....	10-130-1
BOB-TACH (HAND LEVER) .....	10-140-1
Inspection And Maintenance .....	10-140-1
BOB-TACH (POWER) .....	10-141-1
Inspection And Maintenance .....	10-141-1
LUBRICATING THE LOADER .....	10-150-1
Lubrication Locations .....	10-150-1
TIRE MAINTENANCE .....	10-160-1
Wheel Nuts .....	10-160-1
Rotating .....	10-160-1
Mounting .....	10-160-2
SPARK ARRESTER MUFFLER .....	10-170-1
Cleaning Procedure .....	10-170-1
PIVOT PINS .....	10-180-1
Inspection And Maintenance .....	10-180-1
LOADER STORAGE AND RETURN TO SERVICE .....	10-190-1
Storage .....	10-190-1
Return To Service .....	10-190-1
STOPPING THE ENGINE AND LEAVING THE LOADER .....	10-200-1
Procedure .....	10-200-1

EMERGENCY EXIT .....	10-210-1
Rear Window .....	10-210-1
External Access .....	10-210-1
Front Door .....	10-210-2
SEAT BELT .....	10-220-1
Inspection And Maintenance .....	10-220-1

Dealer Copy -- Not for Resale

## LIFTING AND BLOCKING THE LOADER

### Procedure

Figure 10-10-1

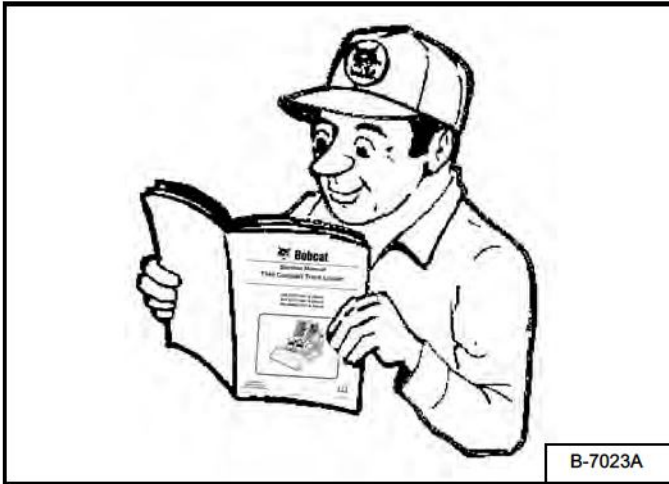

#### AVOID INJURY OR DEATH

Instructions are necessary before operating or servicing machine. Read and understand the Operation & Maintenance Manual, Operator's Handbook and signs (decals) on machine. Follow warnings and instructions in the manuals when making repairs, adjustments or servicing. Check for correct function after adjustments, repairs or service. Untrained operators and failure to follow instructions can cause injury or death.

W-2003-0807

Read the Removal And Installation, Disassembly And Assembly, etc. completely to become familiar with the procedure before beginning [Figure 10-10-1].

Always park the loader on a level surface.



#### MACHINE FALLING OR MOVING CAN CAUSE SERIOUS INJURY OR DEATH

Put jackstands under the front and rear of the machine before running engine for service.

W-2718-0208

Figure 10-10-2



Lift the rear of the loader and install jackstands in the notched area of the frame [Figure 10-10-2].

Figure 10-10-3



Lift the front of the loader and install jackstands under the axle tubes [Figure 10-10-3].

**NOTE:** Make sure the jackstands do not touch the tires. Make sure the tires clear the floor or any obstacles.

**NOTE:** The lift arms are raised for photo clarity.

Dealer Copy -- Not for Resale

## LIFT ARM SUPPORT DEVICE

### Description



Never work on a machine with the lift arms up unless the lift arms are secured by an approved lift arm support device. Failure to use an approved lift arm support device can allow the lift arms or attachment to fall and cause injury or death.

Service lift arm support device if damaged or if parts are missing. Using a damaged lift arm support or with missing parts can cause lift arms to drop causing injury or death.

W-2572-0407

Figure 10-20-1

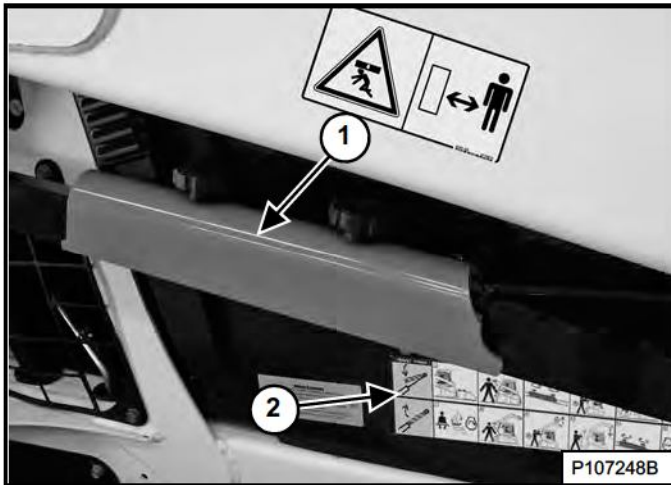

The lift arm support device (Item 1) [Figure 10-20-1] is used to support the lift arms while working on a machine with the lift arms up.

A decal (Item 2) [Figure 10-20-1] located on the right side of the operator cab provides instructions for installing and removing the lift arm support device.

The procedures are described in more detail on the following pages. (See Installing on Page 10-20-2.) and (See Removing on Page 10-20-3.)

## LIFT ARM SUPPORT DEVICE (CONT'D)

### Installing

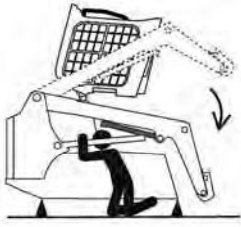

P-90328

#### AVOID DEATH

- Disconnecting or loosening any hydraulic tubeline, hose, fitting, component or a part failure can cause lift arms to drop.
- Keep out of this area when lift arms are raised unless supported by an approved lift arm support. Replace if damaged.

D-1009-0409

Remove attachment from the loader. (See Removal And Installation on Page 50-40-1.) **OR** (See Removal And Installation on Page 50-41-1.)

Figure 10-20-2

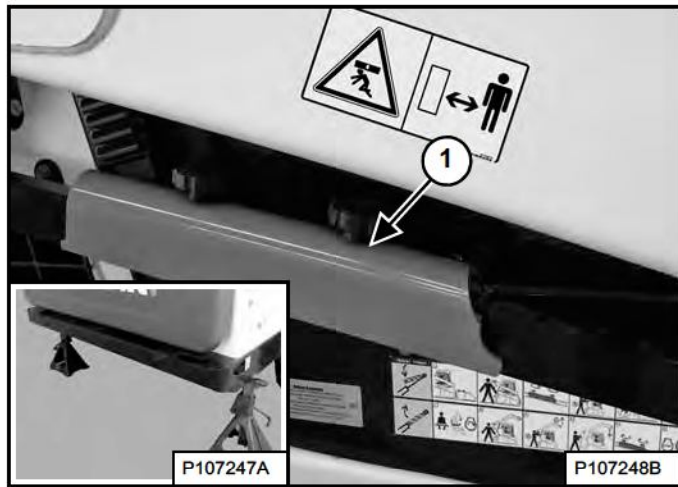

Put jackstands under the rear corners of the loader frame (Inset) [Figure 10-20-2].

Remove the lift arm support device (Item 1) [Figure 10-20-2] from the storage position.

The operator must stay in the operator seat with the seat belt fastened and the seat bar lowered until the lift arm support device is installed.

Start the engine and raise the lift arms all the way up.

Figure 10-20-3



Have a second person install the lift arm support device over the rod of one of the lift cylinders [Figure 10-20-3].

The lift arm support device must be tight against the cylinder rod.

Figure 10-20-4

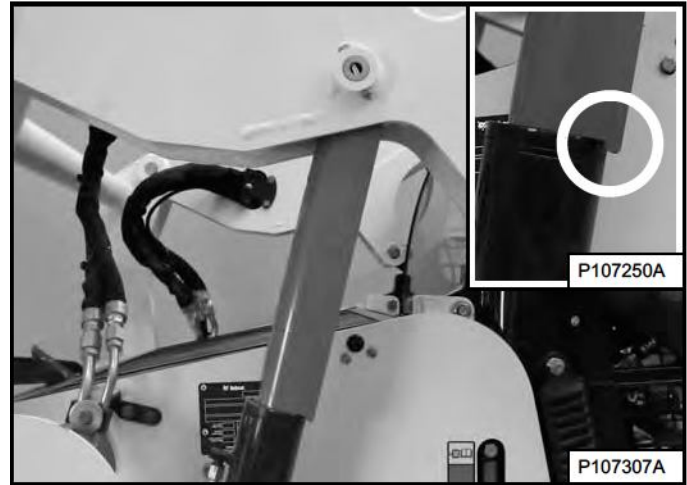

Lower the lift arms slowly until the lift arm support device is held between the lift arms and the lift cylinder. The tabs of the lift arm support device must go past the end of the cylinder (Inset) [Figure 10-20-4].

## LIFT ARM SUPPORT DEVICE (CONT'D)

### Removing



P-90328

#### AVOID DEATH

- Disconnecting or loosening any hydraulic tubeline, hose, fitting, component or a part failure can cause lift arms to drop.
- Keep out of this area when lift arms are raised unless supported by an approved lift arm support. Replace if damaged.

D-1009-0409

The operator must be in the operator's seat, with the seat belt fastened and seat bar lowered, until the lift arm support device is removed, and the lift arms are lowered all the way.

Start the engine and raise the lift arms all the way up.

Figure 10-20-5



Have a second person remove the lift arm support device [Figure 10-20-5].

Lower the lift arms all the way and stop the engine.

Figure 10-20-6



Return the lift arm support device to the storage position and secure with clamping knobs [Figure 10-20-6].

Remove the jackstands.

## OPERATOR CAB

### Description

The Bobcat loader has an operator cab (ROPS and FOPS) as standard equipment to protect the operator from rollover and falling objects. The seat belt must be worn for rollover protection.

Check the cab, mounting, and hardware for damage. Never modify the cab. Replace the cab and hardware if damaged. See your Bobcat dealer for parts.

ROPS - Roll-Over Protective Structure per ISO 3471 and FOPS - Falling-Object Protective Structure per ISO 3449, Level I. Level II is available.

#### *Level I*

Protection from falling bricks, small concrete blocks, and hand tools encountered in operations, such as: highway maintenance, landscaping, and other construction sites.

#### *Level II*

Protection from falling trees, rocks: for machines involved in site clearing, overhead demolition, or forestry.



**Never modify operator cab by welding, grinding, drilling holes or adding attachments unless instructed to do so by Bobcat Company. Changes to the cab can cause loss of operator protection from rollover and falling objects, and result in injury or death.**

W-2069-0200

## OPERATOR CAB (CONT'D)

### Raising

Always stop the engine before raising or lowering the operator cab.

Stop the loader on a level surface. Lower the lift arms. If the lift arms must be up while raising the operator cab, install the lift arm support device. (See LIFT ARM SUPPORT DEVICE on Page 10-20-1.)

Figure 10-30-1

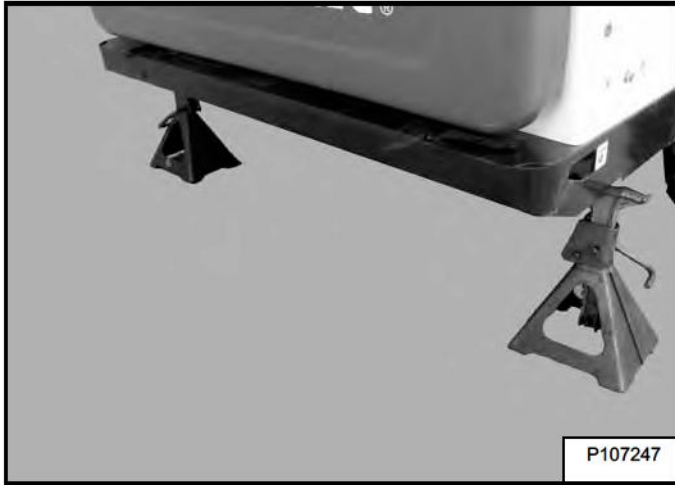

Install jackstands under the rear of the loader frame [Figure 10-30-1].

Figure 10-30-2

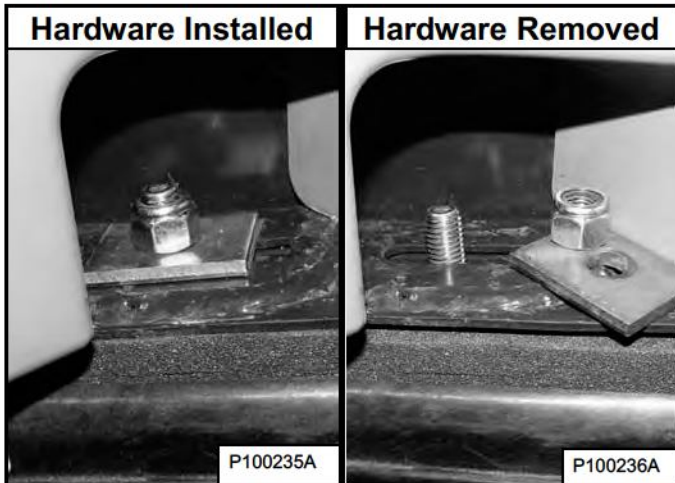

Remove the nuts and washers [Figure 10-30-2] (both sides) at the front corners of the operator cab.

## **WARNING**

**UNEXPECTED LOADER, LIFT ARM OR ATTACHMENT MOVEMENT CAUSED BY CAB CONTACT WITH CONTROLS CAN CAUSE SERIOUS INJURY OR DEATH**

- **STOP ENGINE** before raising or lowering cab.

W-2758-0908

**NOTE:** On some machines, the operator cab frame can contact the steering levers while raising or lowering the operator cab. The engine **MUST** be stopped before raising or lowering the operator cab.

Figure 10-30-3



Lift on the grab handles and bottom of the operator cab [Figure 10-30-3] slowly until the operator cab is all the way up and the latching mechanism engages.

Dealer Copy -- Not for Resale

## OPERATOR CAB (CONT'D)

### Lowering

Always stop the engine before raising or lowering the operator cab.

**NOTE:** Always use the grab handles to lower the operator cab.

Figure 10-30-4



Pull down on the bottom of the operator cab until it stops at the latching mechanism [Figure 10-30-4].

**NOTE:** The weight of the operator cab increases when equipped with options and accessories, such as: cab door and heater. In these cases, the operator cab may need to be raised slightly from the latch to be able to release the latch.



**UNEXPECTED LOADER, LIFT ARM OR ATTACHMENT MOVEMENT CAUSED BY CAB CONTACT WITH CONTROLS CAN CAUSE SERIOUS INJURY OR DEATH**

- **STOP ENGINE** before raising or lowering cab.

W-2758-0908

**NOTE:** On some machines, the operator cab frame can contact the steering levers while raising or lowering the operator cab. The engine **MUST** be stopped before raising or lowering the operator cab.

Support the operator cab and release the latching mechanism (Inset) [Figure 10-30-4]. Remove your hand from the latch mechanism when the operator cab is past the latch stop. Use both hands to lower the operator cab all the way down.



**PINCH POINT CAN CAUSE INJURY**

Remove your hand from the latching mechanism when the cab is past the latch stop.

W-2469-0803

Figure 10-30-5

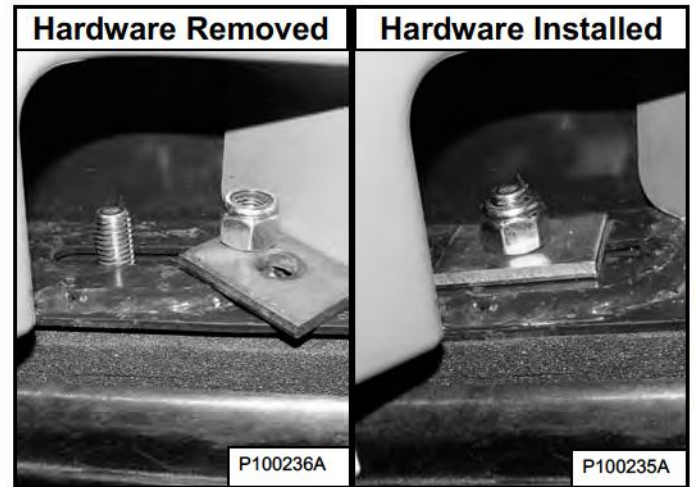

Install the washers and nuts (both sides) [Figure 10-30-5].

Tighten the nuts to 54 - 61 N•m (40 - 45 ft-lb) torque.

Dealer Copy -- Not for Resale

## OPERATOR CAB (CONT'D)

### Cab Door Sensor

This machine may be equipped with a Cab Door Sensor.

Figure 10-30-6

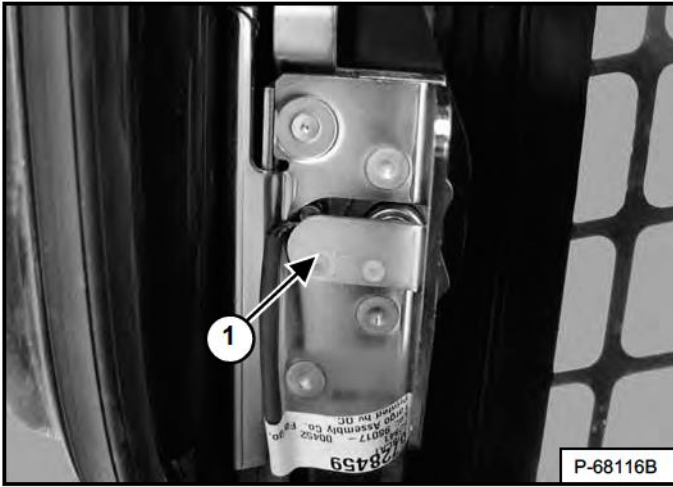

The cab door has a sensor (Item 1) [Figure 10-30-6] installed that deactivates the lift and tilt valves when the door is open.

Figure 10-30-7



The LIFT AND TILT VALVE light (Item 1) [Figure 10-30-7] is OFF when the door is closed, the key switch is turned to RUN, the seat bar is lowered, and the PRESS TO OPERATE LOADER button is pressed.

The LIFT AND TILT VALVE light (Item 1) [Figure 10-30-7] is ON when the door is open, the key switch is turned to RUN, the seat bar is lowered, and the PRESS TO OPERATE LOADER button is pressed.

[DOOR] (Item 2) will appear in the data display [Figure 10-30-7] when the door is open, the key switch is turned to RUN, the seat bar is lowered, and the PRESS TO OPERATE LOADER button is pressed.

## Special Applications Kit

# ! WARNING

### AVOID INJURY OR DEATH

Some attachment applications can cause flying debris or objects to enter front, top or rear cab openings. Install the Special Applications Kit to provide added operator protection in these applications.

W-2737-0508

Figure 10-30-8

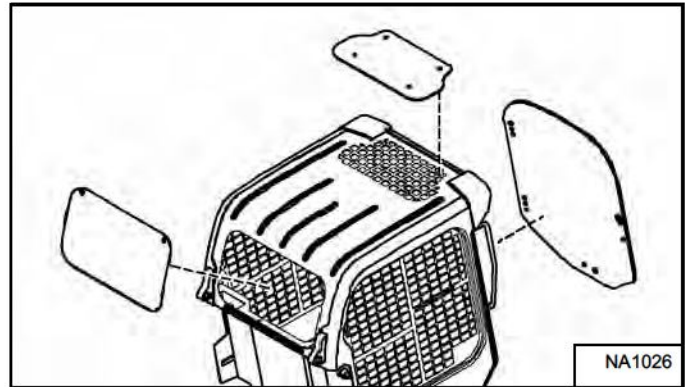

Available for special applications to restrict material from entering cab openings. Kit includes 12,7 mm (0.50 in) thick polycarbonate front door and polycarbonate rear window [Figure 10-30-8].

Polycarbonate top window (standard item) must be installed for special applications to restrict material from entering cab openings.

See your Bobcat dealer for availability.

### Special Applications Kit Inspection And Maintenance

- Inspect for cracks or damage. Replace if required.
- Pre-rinse with water to remove gritty materials.
- Wash with a mild household detergent and warm water.
- Use a sponge or soft cloth. Rinse well with water and dry with a clean soft cloth or rubber squeegee.
- Do not use abrasive or highly alkaline cleaners.
- Do not clean with metal blades or scrapers.

## OPERATOR CAB (CONT'D)

### Forestry Door And Window Kit

Figure 10-30-9

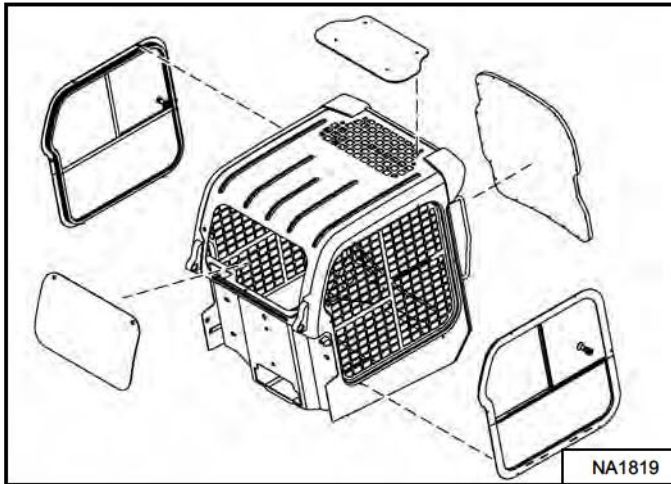

Available for special applications to prevent flying debris and objects from entering the cab. Kit includes 19,1 mm (0.75 in) thick laminated polycarbonate front door, polycarbonate side windows, and polycarbonate rear window [Figure 10-30-9].

Polycarbonate top window (standard item) must be installed as part of the Forestry Door And Window Kit to restrict material from entering cab openings.

### Forestry Door And Window Kit Inspection And Maintenance

- Inspect for cracks or damage. Replace if required.
- Order part number 7171104 if door frame is damaged and needs to be replaced.
- Order kit part number 7193293 if door polycarbonate is damaged and needs to be replaced.
- Prerinse with water to remove gritty materials.
- Wash with a mild household detergent and warm water.
- Use a sponge or soft cloth. Rinse well with water and dry with a clean soft cloth or rubber squeegee.
- Do not use abrasive or highly alkaline cleaners.
- Do not clean with metal blades or scrapers.

### Forestry Door Emergency Exit

Figure 10-30-10

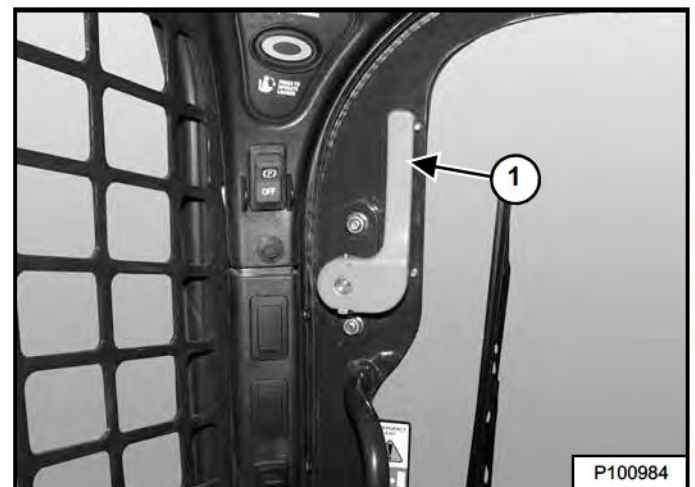

- Inspect both emergency exit levers (Item 1) [Figure 10-30-10], linkages, and hardware for loose or damaged parts.
- Repair or replace if necessary.

Dealer Copy -- Not for Resale

## TRANSPORTING THE LOADER ON A TRAILER

### Loading And Unloading



#### AVOID SERIOUS INJURY OR DEATH

Adequately designed ramps of sufficient strength are needed to support the weight of the machine when loading onto a transport vehicle. Wood ramps can break and cause personal injury.

W-2058-0807

Be sure the transport and towing vehicles are of adequate size and capacity for weight of loader. (See Performance on Page SPEC-10-2.)

Figure 10-40-1



A loader with an empty bucket or no attachment must be loaded backward onto the transport vehicle [Figure 10-40-1].

The rear of the trailer must be blocked or supported (Item 1) [Figure 10-40-1] when loading or unloading the loader to prevent the front end of the trailer from raising up.

### Fastening

Figure 10-40-2

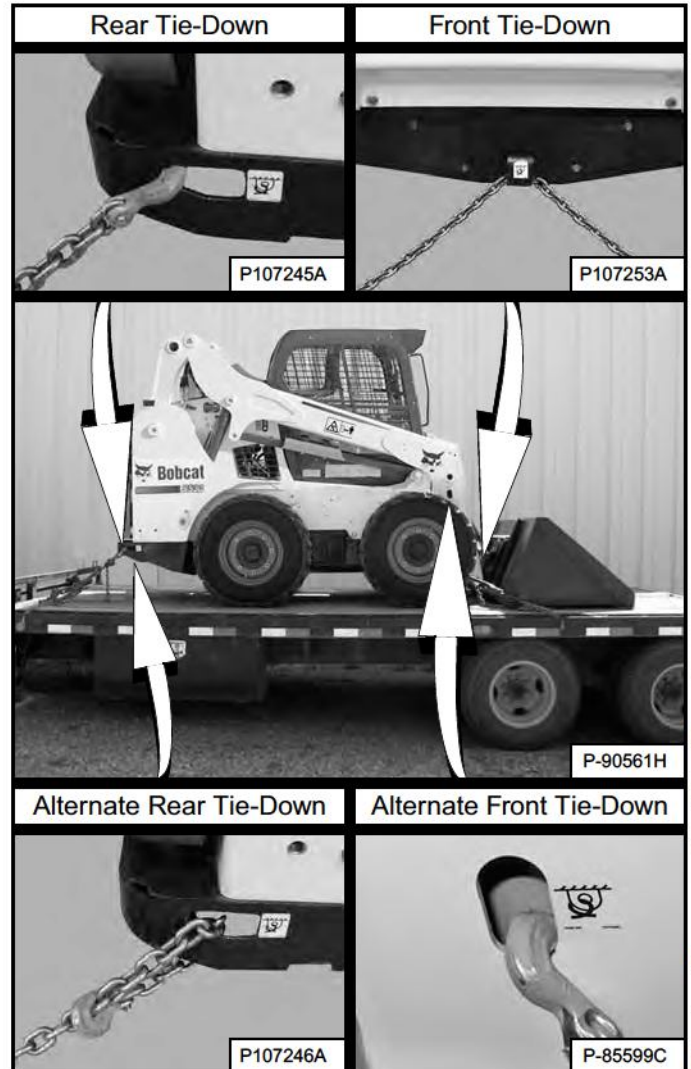

Use the following procedure to fasten the Bobcat loader to the transport vehicle to prevent the loader from moving during sudden stops, or when going up or down slopes [Figure 10-40-2].

1. Lower the bucket or attachment to the floor.
2. Stop the engine.
3. Engage the parking brake.
4. Install chains at the front and rear loader tie-down positions [Figure 10-40-2]. (Lift arms shown raised for visual clarity.)
5. Fasten each end of the chain to the transport vehicle.
6. Use chain binders to tighten the chains.

Dealer Copy -- Not for Resale



**Suggest:**

**If the above button click is invalid.**

**Please download this document**

**first, and then click the above link**

**to download the complete manual.**

**Thank you so much for reading**

## TOWING THE LOADER

### Procedure

Because of the design of the loader, there is not a recommended towing procedure.

- The loader can be lifted onto a transport vehicle.
- The loader can be skidded a short distance to move for service (EXAMPLE: Move onto a transport vehicle.) without damage to the hydrostatic system. (The tires will not turn.) There may be slight wear to the tires when the loader is skidded.

The towing chain (or cable) must be rated at 1.5 times the weight of the loader. (See Performance on Page SPEC-10-2.)

**<https://www.ebooklibonline.com>**

Hello dear friend!

Thank you very much for reading.

Enter the link into your browser.

The full manual is available for immediate download.

**<https://www.ebooklibonline.com>**