



# Bobcat®

---

## Service Manual

# S130 Skid-Steer Loader

---

S/N 529211001 & Above  
S/N 529611001 & Above  
S/N A84W11001 & Above  
S/N A1Z711001 - A1Z759999  
S/N A8NW11001 & Above  
S/N A8KA11001 - A8KA59999

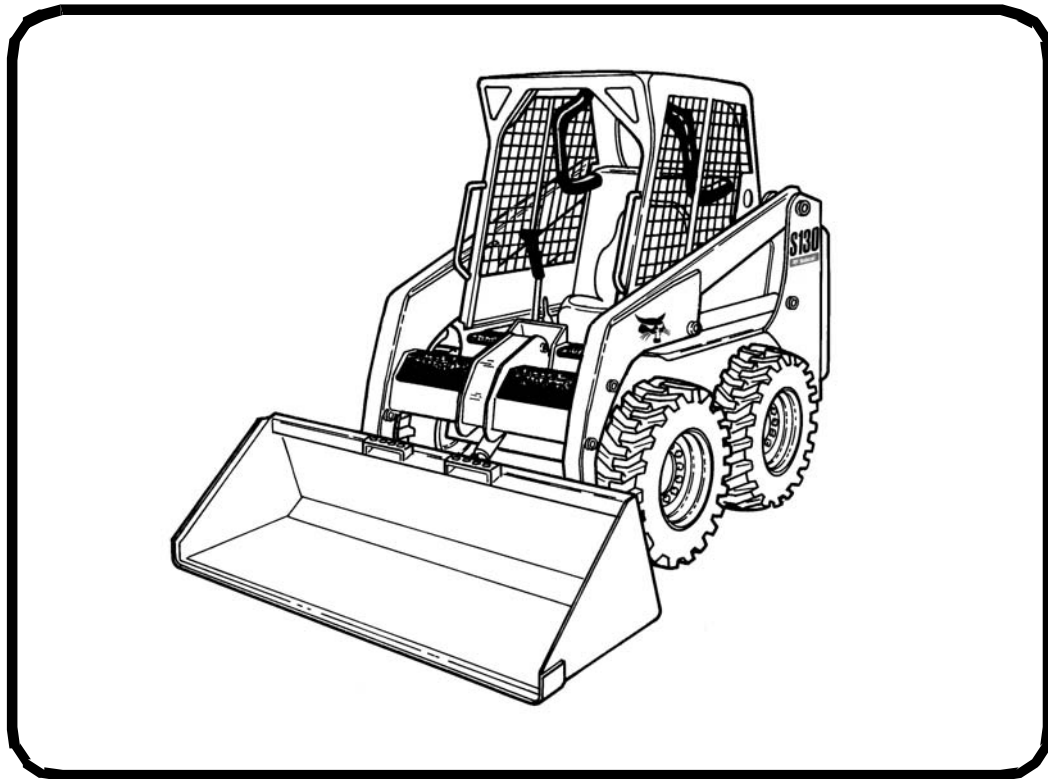

EQUIPPED WITH  
BOBCAT INTERLOCK  
CONTROL SYSTEM (BICS)



# MAINTENANCE SAFETY



## WARNING

Instructions are necessary before operating or servicing machine. Read and understand the Operation & Maintenance Manual, Operator's Handbook and signs (decals) on machine. Follow warnings and instructions in the manuals when making repairs, adjustments or servicing. Check for correct function after adjustments, repairs or service. Untrained operators and failure to follow instructions can cause injury or death.

W-2003-0903



**Safety Alert Symbol:** This symbol with a warning statement, means: "Warning, be alert! Your safety is involved!" Carefully read the message that follows.

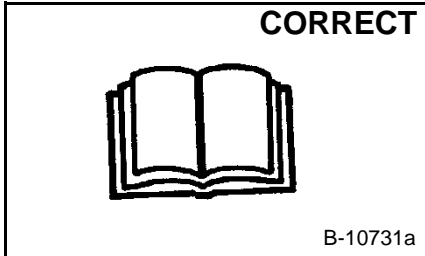

Never service the Bobcat Skid-Steer Loader without instructions.

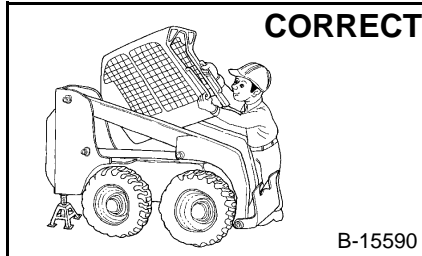

Use the correct procedure to lift or lower operator cab.

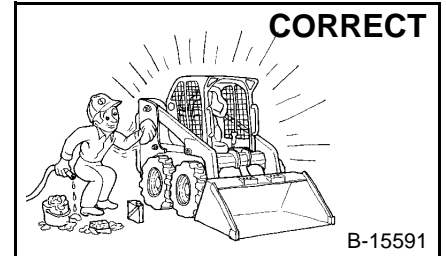

Cleaning and maintenance are required daily.

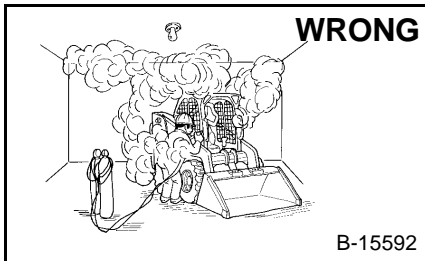

- Have good ventilation when welding or grinding painted parts.
- Wear dust mask when grinding painted parts. Toxic dust and gas can be produced.
- Avoid exhaust fume leaks which can kill without warning. Exhaust system must be tightly sealed.

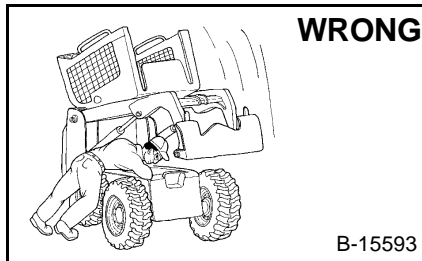

Disconnecting or loosening any hydraulic tubeline, hose, fitting, component or a part failure can cause lift arms to drop. Do not go under lift arms when raised unless supported by an approved lift arm support device. Replace it if damaged.

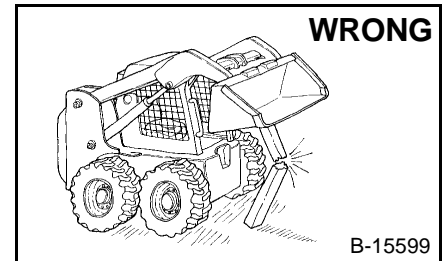

- Never work on loader with lift arms up unless lift arms are held by an approved lift arm support device. Replace if damaged.
- Never modify equipment or add attachments not approved by Bobcat Company.

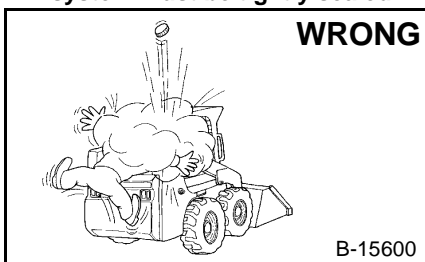

- Stop, cool and clean engine of flammable materials before checking fluids.
- Never service or adjust loader with the engine running unless instructed to do so in the manual.
- Avoid contact with leaking hydraulic fluid or diesel fuel under pressure. It can penetrate the skin or eyes.
- Never fill fuel tank with engine running, while smoking or when near open flame.

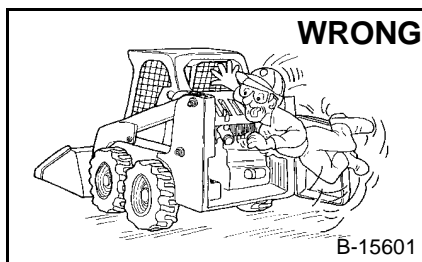

- Keep body, jewelry and clothing away from moving parts, electrical contact, hot parts and exhaust.
- Wear eye protection to guard from battery acid, compressed springs, fluids under pressure and flying debris when engines are running or tools are used. Use eye protection approved for type of welding.
- Keep rear door closed except for service. Close and latch door before operating the loader.

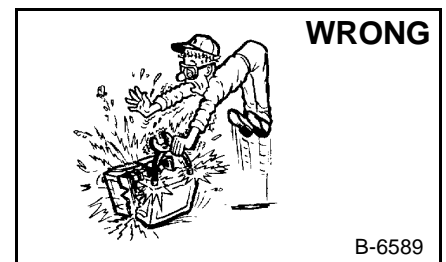

- Lead-acid batteries produce flammable and explosive gases.
- Keep arcs, sparks, flames and lighted tobacco away from batteries.
- Batteries contain acid which burns eyes or skin on contact. Wear protective clothing. If acid contacts body, flush well with water. For eye contact flush well and get immediate medical attention.

Maintenance procedures which are given in the Operation & Maintenance Manual can be performed by the owner/operator without any specific technical training. Maintenance procedures which are **not** in the Operation & Maintenance Manual must be performed **ONLY BY QUALIFIED BOBCAT SERVICE PERSONNEL**. Always use genuine Bobcat replacement parts. The Service Safety Training Course is available from your Bobcat dealer.

## ALPHABETICAL INDEX

AIR CLEANER .....	70-01	FINAL DRIVE TRANSMISSTION (CHAINCASE)....	10-01
AIR CLEANER SERVICE .....	10-01	FLYWHEEL AND HOUSING .....	70-01
ALTERNATOR .....	60-01	FLYWHEEL RPM SENSOR .....	60-01
		FRONT AUXILIARY HYDRAULIC	
BACK-UP ALARM SYSTEM .....	60-01	COUPLER BLOCK .....	20-01
BATTERY .....	60-01	FUEL SYSTEM.....	10-01, 70-01
BOBCAT CONTROLLER (ACS) .....	60-01	FUEL TANK .....	50-01
BOBCAT CONTROLLER (MAIN).....	60-01		
BOBCAT CONTROLLER (SJC) (DRIVE) .....	60-01	HEATER COIL .....	80-01
BOBCAT INTERLOCK CONTROL		HEATER FAN .....	80-01
SYSTEM (BICS) .....	60-01	HEATER SYSTEM.....	80-01
BOB-TACH (HAND LEVER) .....	10-01, 50-01	HEATER UNIT .....	80-01
BOB-TACH (POWER).....	10-01	HEATER VALVE .....	80-01
BOB-TACH (POWER-OPTION).....	50-01	HYDRAULIC CONNECTION SPECS .....	SPEC-01
BOB-TACH (POWER) BLOCK.....	20-01	HYDRAULIC CONTROL VALVE (ACS) OR (SJC) ..	20-01
BRAKE .....	40-01	HYDRAULIC CONTROL VALVE (STANDARD) .....	20-01
BUCKET POSITION VALVE .....	20-01	HYDRAULIC/HYDROSTATIC FILTERS .....	20-01
		HYDRAULIC FLUID RESERVOIR .....	20-01
CALIBRATION .....	60-01	HYDRAULIC/HYDROSTATIC	
CAMSHAFT AND TIMING GEARS.....	70-01	FLUID SPECIFICATIONS.....	SPEC-01
CASE DRAIN FILTER .....	30-01	HYDRAULIC/HYDROSTATIC SYSTEM.....	10-01
CHAINCASE .....	40-01	HYDRAULIC PUMP (STANDARD).....	20-01
CHARGE PRESSURE .....	30-01	HYDRAULIC PUMP (SJC) .....	20-01
CONTROL HANDLE/LEVER .....	50-01	HYDRAULIC SYSTEM INFORMATION .....	20-01
CONTROL HANDLE/LEVER (ACS) .....	50-01	HYDROSTATIC MOTOR .....	30-01
CONTROL HANDLE/LEVER (SJC).....	50-01	HYDROSTATIC MOTOR CARRIER.....	30-01
CONTROL PANEL .....	50-01	HYDROSTATIC MOTOR CARRIER (SJC).....	30-01
CONTROL PANEL (SJC).....	50-01	HYDROSTATIC PUMP .....	30-01
CONTROL PANEL SETUP .....	60-01	HYDROSTATIC PUMP (SJC).....	30-01
CONTROL PEDALS AND LINKAGE .....	50-01	HYDROSTATIC SYSTEM INFORMATION.....	30-01
CONTROL PEDALS (ACS) .....	50-01		
CONTROL SYSTEM (ACS).....	60-01	INSTRUMENT PANELS .....	60-01
CONVERSIONS .....	SPEC-01		
CRANKSHAFT AND PISTONS .....	70-01	LIFT ARMS .....	50-01
CYLINDER (BOB-TACH) .....	20-01	LIFT ARM BYPASS CONTROL VALVE .....	20-01
CYLINDER (LIFT) .....	20-01	LIFT ARM SUPPORT DEVICE.....	10-01
CYLINDER (TILT) .....	20-01	LIFTING AND BLOCKING THE LOADER.....	10-01
CYLINDER HEAD.....	70-01	LIGHTS.....	60-01
		S130 LOADER SPECIFICATIONS.....	SPEC-01
DIAGNOSTICS SERVICE CODES.....	60-01	LOADER STORAGE AND RETURN TO SERVICE	10-01
DRIVE BELT .....	30-01	LUBRICATING THE LOADER.....	10-01
DRIVE COMPONENTS.....	40-01	LUBRICATION SYSTEM.....	70-01
ELECTRICAL/HYD. CONTROLS .....	60-01	MAIN RELIEF VALVE .....	20-01
ELECTRICAL/HYDRAULIC CONTROLS		MAINTENANCE CLOCK .....	60-01
REFERENCE (SJC).....	60-01	MUFFLER.....	70-01
ELECTRICAL SYSTEM INFORMATION .....	60-01		
ENGINE COOLING SYSTEM.....	10-01, 70-01	OIL COOLER.....	20-01
ENGINE LUBRICATION SYSTEM .....	10-01	OPERATOR CAB .....	10-01, 50-01
ENGINE INFORMATION .....	70-01	OPERATOR SEAT .....	50-01
ENGINE SPEED CONTROL .....	70-01	OPERATOR SEAT (SUSPENSION).....	50-01
ENGINE SPEED CONTROL (SJC) .....	70-01		
		PASSWORD SETUP (IF EQUIPPED WITH	
		KEYLESS START).....	60-01
		PIVOT PINS .....	10-01

**<https://www.ebooklibonline.com>**

Hello dear friend!

Thank you very much for reading.

Enter the link into your browser.

The full manual is available for immediate download.

**<https://www.ebooklibonline.com>**

## ALPHABETICAL INDEX (CONT'D)

REAR AUXILIARY DIVERTER VALVE .....	20-01
REAR DOOR .....	50-01
REAR GRILL .....	50-01
REGULAR MAINTENANCE .....	80-01
REMOTE START TOOL KIT-MEL1563 .....	10-01
REMOTE START TOOL (SERVICE TOOL) KIT-6689779 .....	10-01
SEAT BAR.....	50-01
SEAT BAR SENSOR .....	60-01
SERVICE PC (LAPTOP COMPUTER) .....	60-01
SERVICE SCHEDULE .....	10-01
SPARK ARRESTOR MUFFLER .....	10-01
STARTER .....	60-01
STEERING DRIFT COMPENSATION .....	60-01
STOPPING THE ENGINE AND LEAVING THE LOADER .....	10-01
TIRE MAINTENANCE .....	10-01
TORQUE SPECIFICATIONS FOR BOLTS.....	SPEC-01
TOWING THE LOADER .....	10-01
TRACTION LOCK.....	60-01
TRANSPORTING THE BOBCAT LOADER.....	10-01
TROUBLESHOOTING.....	80-01
WHEEL SPEED SENDORS (SJC).....	60-01
WINDOW (FRONT DOOR) .....	50-01
WINDOW (REAR).....	50-01
WINDOW (SIDE) .....	50-01
WINDOW (TOP) .....	50-01

## CONTENTS

**SAFETY &  
MAINTENANCE**

**HYDRAULIC  
SYSTEM**

**HYDROSTATIC  
SYSTEM**

**DRIVE  
SYSTEM**

**MAIN FRAME**

**ELECTRICAL  
SYSTEM &  
ANALYSIS**

**ENGINE  
SERVICE**

**HEATER**

**SPECIFICATIONS**

FOREWORD.....	II
SAFETY INSTRUCTIONS .....	V
SERIAL NUMBER LOCATIONS .....	IX
DELIVERY REPORT.....	X
LOADER IDENTIFICATION .....	XI
SAFETY AND MAINTENANCE.....	10-01
HYDRAULIC SYSTEM .....	20-01
HYDROSTATIC SYSTEM.....	30-01
DRIVE SYSTEM .....	40-01
MAIN FRAME .....	50-01
ELECTRICAL SYSTEM & ANALYSIS.....	60-01
ENGINE SERVICE .....	70-01
HEATER .....	80-01
SPECIFICATIONS.....	SPEC-01

# FOREWORD

This manual is for the Bobcat loader mechanic. It provides necessary servicing and adjustment procedures for the Bobcat loader and its component parts and systems. Refer to the Operation & Maintenance Manual for operating instructions, starting procedure, daily checks, etc.

A general inspection of the following items must be made after the loader has had service or repair:

1. Check that the ROPS/FOPS (Including side screens) is in good condition and is not modified.

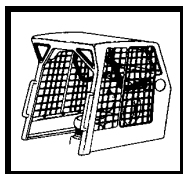

2. Check that ROPS mounting hardware is tightened and is Bobcat approved.

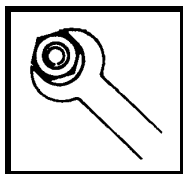

3. The seat belt must be correctly installed, functional and in good condition.

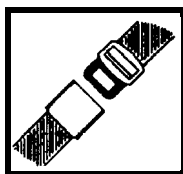

4. The seat bar must be correctly adjusted, clean and lubricated.

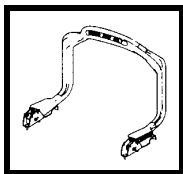

5. Check lift arm support device, replace if damaged.



6. Machine signs (decals) must be legible and in the correct location.



7. Steering levers, hand controls and foot pedals must return to neutral (as applicable).

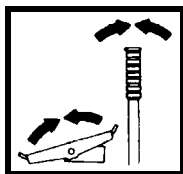

8. Check for correct function of the work lights



9. The parking brake must function correctly.

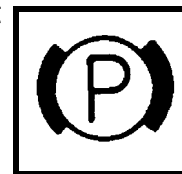

10. Enclosure door latches must open and close freely.

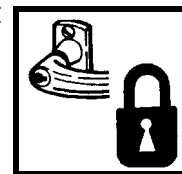

11. Bob-Tach wedges and linkages must function correctly and be in good condition.

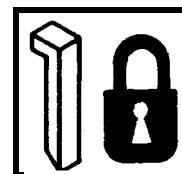

12. Safety treads must be in good condition.

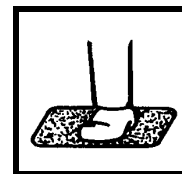

13. Check for correct function of indicator lamps (Optional on some models).

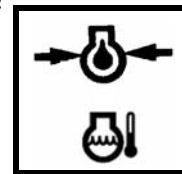

14. Check hydraulic fluid level, engine oil level and fuel supply.

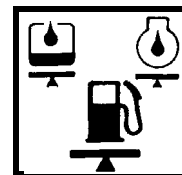

15. Inspect for fuel, oil or hydraulic fluid leaks.

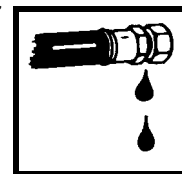

16. Lubricate the loader.



17. Check the condition of the battery and cables.



18. Inspect the air cleaner for damage or leaks. Check the condition of the element.

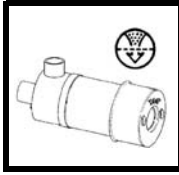

19. Check the electrical charging system.

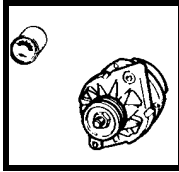

20. Check tires for wear and pressure.

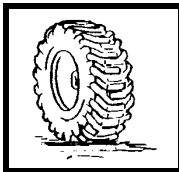

21. Inspect for loose or broken parts or connections.

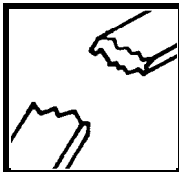

22. Operate the loader and check all functions.

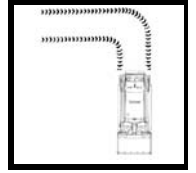

23. Check for any field modification not completed.



24. Check for correct function of the Bobcat Interlock Control System (BICST<sup>™</sup>) before the machine is returned to the customer.



25. Recommend to the owner that all necessary corrections be made before the machine is returned to service.

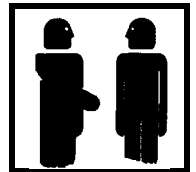

26. Check function or condition of all equipped options and accessories (examples: back-up alarm, fire extinguisher, rotating beacon, lift kits, etc.).



**CALIFORNIA  
PROPOSITION 65 WARNING**

Diesel engine exhaust and some of its constituents are known to the state of California to cause cancer, birth defects and other reproductive harm.

## SAFETY INSTRUCTIONS



### Safety Alert Symbol

This symbol with a warning statement means:  
“Warning, be alert! Your safety is involved!”  
Carefully read the message that follows.



## WARNING

Instructions are necessary before operating or servicing machine. Read and understand the Operation & Maintenance Manual, Operator's Handbook and signs (decals) on machine. Follow warnings and instructions in the manuals when making repairs, adjustments or servicing. Check for correct function after adjustments, repairs or service. Untrained operators and failure to follow instructions can cause injury or death.

W-2003-0903



## WARNING

Warnings on the machine and in the manuals are for your safety. Failure to obey warnings can cause injury or death.

W-2044-1285

## IMPORTANT

This notice identifies procedures which must be followed to avoid damage to the machine.

I-2019-0284

The following publications provide information on the safe use and maintenance of the Bobcat machine and attachments:

- The Delivery Report is used to assure that complete instructions have been given to the new owner and that the machine is in safe operating condition.
- The Operation & Maintenance Manual delivered with the machine or attachment contains operating information as well as routine maintenance and service procedures. It is a part of the machine and can be stored in a container provided on the machine. Replacement Operation & Maintenance Manuals can be ordered from your Bobcat dealer.
- Machine signs (decals) instruct on the safe operation and care of your Bobcat machine or attachment. The signs and their locations are shown in the Operation & Maintenance Manual. Replacement signs are available from your Bobcat dealer.
- An Operator's Handbook fastened to the operator cab. It's brief instructions are convenient to the operator. The handbook is available from your dealer in an English edition or one of many other languages. See your Bobcat dealer for more information on translated versions.
- The AEM Safety Manual delivered with the machine gives general safety information.
- The Service Manual and Parts Manual are available from your dealer for use by mechanics to do shop-type service and repair work.
- The Skid-Steer Loader Operator Training Course is available through your local dealer or at [www.training.bobcat.com](http://www.training.bobcat.com) or [www.bobcat.com](http://www.bobcat.com). This course is intended to provide rules and practices of correct operation of the Skid-Steer Loader. The course is available in English and Spanish versions.
- Service Safety Training Courses are available from your Bobcat dealer or at [www.training.bobcat.com](http://www.training.bobcat.com) or [www.bobcat.com](http://www.bobcat.com). They provide information for safe and correct service procedures.
- The Skid-Steer Loader Safety Video is available from your Bobcat dealer or at [www.training.bobcat.com](http://www.training.bobcat.com) or [www.bobcat.com](http://www.bobcat.com).

## SAFETY INSTRUCTIONS (CONT'D)

The dealer and owner / operator review the recommended uses of the product when delivered. If the owner / operator will be using the machine for a different application(s) he or she must ask the dealer for recommendations on the new use.



Cutting or drilling concrete containing sand or rock containing quartz may result in exposure to silica dust. Do not exceed Permissible Exposure Limits (PEL) to silica dust as determined by OSHA or other job site Rules and Regulations. Use a respirator, water spray or other means to control dust. Silica dust can cause lung disease and is known to the state of California to cause cancer.

**Call Before You Dig**  
**Dial 811 (USA Only)**  
**1-888-258-0808 (USA & Canada)**

When you call, you will be directed to a location in your state / province, or city for information about buried lines (telephone, cable TV, water, sewer, gas, etc.).

## FIRE PREVENTION



### Maintenance

The machine and some attachments have components that are at high temperatures under normal operating conditions. The primary source of high temperatures is the engine and exhaust system. The electrical system, if damaged or incorrectly maintained, can be a source of arcs or sparks.

Flammable debris (leaves, straw, etc.) must be removed regularly. If flammable debris is allowed to accumulate, it can cause a fire hazard. Clean often to avoid this accumulation. Flammable debris in the engine compartment is a potential fire hazard.

The operator's area, engine compartment and engine cooling system must be inspected every day and cleaned if necessary to prevent fire hazards and overheating.

All fuels, most lubricants and some coolants mixtures are flammable. Flammable fluids that are leaking or spilled onto hot surfaces or onto electrical components can cause a fire.

### Operation

Do not use the machine where exhaust, arcs, sparks or hot components can contact flammable material, explosive dust or gases.

### Electrical



Check all electrical wiring and connections for damage. Keep the battery terminals clean and tight. Repair or replace any damaged part or wires that are loose or frayed.

Battery gas can explode and cause serious injury. Use the procedure in the Operation & Maintenance Manual for connecting the battery and for jump starting. Do not jump start or charge a frozen or damaged battery. Keep any open flames or sparks away from batteries. Do not smoke in battery charging area.

## Hydraulic System

Check hydraulic tubes, hoses and fittings for damage and leakage. Never use open flame or bare skin to check for leaks. Hydraulic tubes and hoses must be properly routed and have adequate support and secure clamps. Tighten or replace any parts that show leakage.

Always clean fluid spills. Do not use gasoline or diesel fuel for cleaning parts. Use commercial nonflammable solvents.

### Fueling



Stop the engine and let it cool before adding fuel. No smoking! Do not refuel a machine near open flames or sparks. Fill the fuel tank outdoors.

### Starting

Do not use ether or starting fluids on any engine that has glow plugs. These starting aids can cause explosion and injure you or bystanders.

Use the procedure in the Operation & Maintenance Manual for connecting the battery and for jump starting.

## Spark Arrestor Exhaust System

The spark arrestor exhaust system is designed to control the emission of hot particles from the engine and exhaust system, but the muffler and the exhaust gases are still hot.

Check the spark arrestor exhaust system regularly to make sure it is maintained and working properly. Use the procedure in the Operation & Maintenance Manual for cleaning the spark arrestor muffler (if equipped).

## **FIRE PREVENTION (CONT'D)**

### **Welding And Grinding**

Always clean the machine and attachment, disconnect the battery, and disconnect the wiring from the Bobcat controllers before welding. Cover rubber hoses, battery and all other flammable parts. Keep a fire extinguisher near the machine when welding.

Have good ventilation when grinding or welding painted parts. Wear dust mask when grinding painted parts. Toxic dust or gas can be produced.

Dust generated from repairing nonmetallic parts such as hoods, fenders or covers can be flammable or explosive. Repair such components in a well ventilated area away from open flames or sparks.

### **Fire Extinguishers**

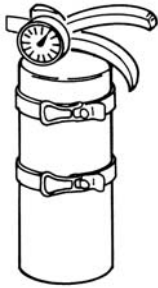

Know where fire extinguishers and first aid kits are located and how to use them. Inspect the fire extinguisher and service the fire extinguisher regularly. Obey the recommendations on the instructions plate.

## SERIAL NUMBER LOCATIONS

Always use the serial number of the loader when requesting service information or when ordering parts. Early or later models (identification made by serial number) may use different parts, or it may be necessary to use a different procedure in doing a specific service operation.

### Loader Serial Number

Figure 1

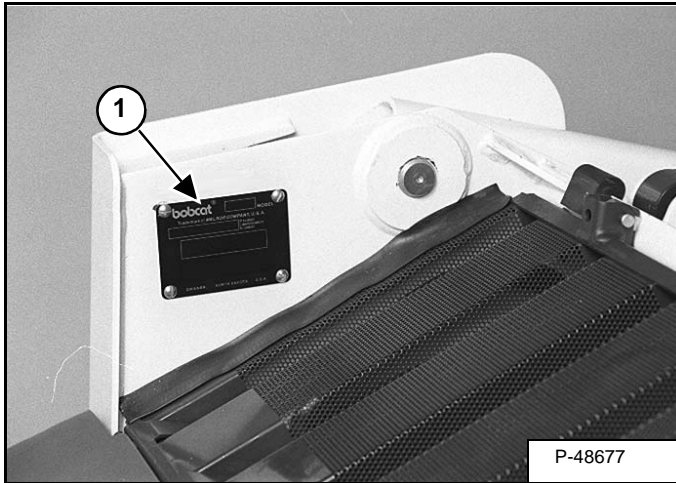

The loader serial number plate is located on the outside of the loader frame [Figure 1].

Explanation of loader Serial Number:

XXXX	XXXXX
Model 1.-Model/ Engine Combination	Model 2.-Production Sequence (Series)

1. The four digit Model/Engine Combination Module number identifies the model number and engine combination.
2. The five digit Production Sequence Number identifies the order which the loader is produced.

### Engine Serial Number

Figure 2

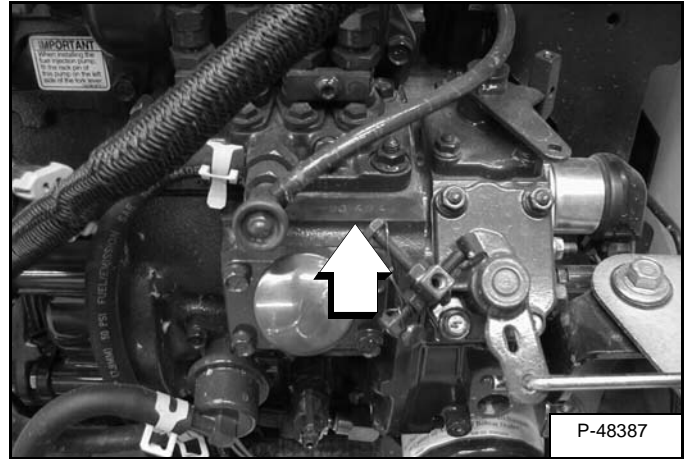

The engine serial number is in the location shown [Figure 2].

## DELIVERY REPORT

Figure 3

The diagram shows a form layout for a delivery report. It features a main title 'DELIVERY REPORT' at the top right. Below this, there are two columns of horizontal lines representing text input fields. A prominent 'WARNING' section is located in the middle left, with a dark background for the header. The bottom right corner of the form includes a small box containing the alphanumeric code 'B-16315'.

The Delivery Report must be filled out by the dealer and signed by the owner or operator when the Bobcat loader is delivered. An explanation of the form must be given to the owner. Make sure it is filled out completely **[Figure 3]**.

## LOADER IDENTIFICATION

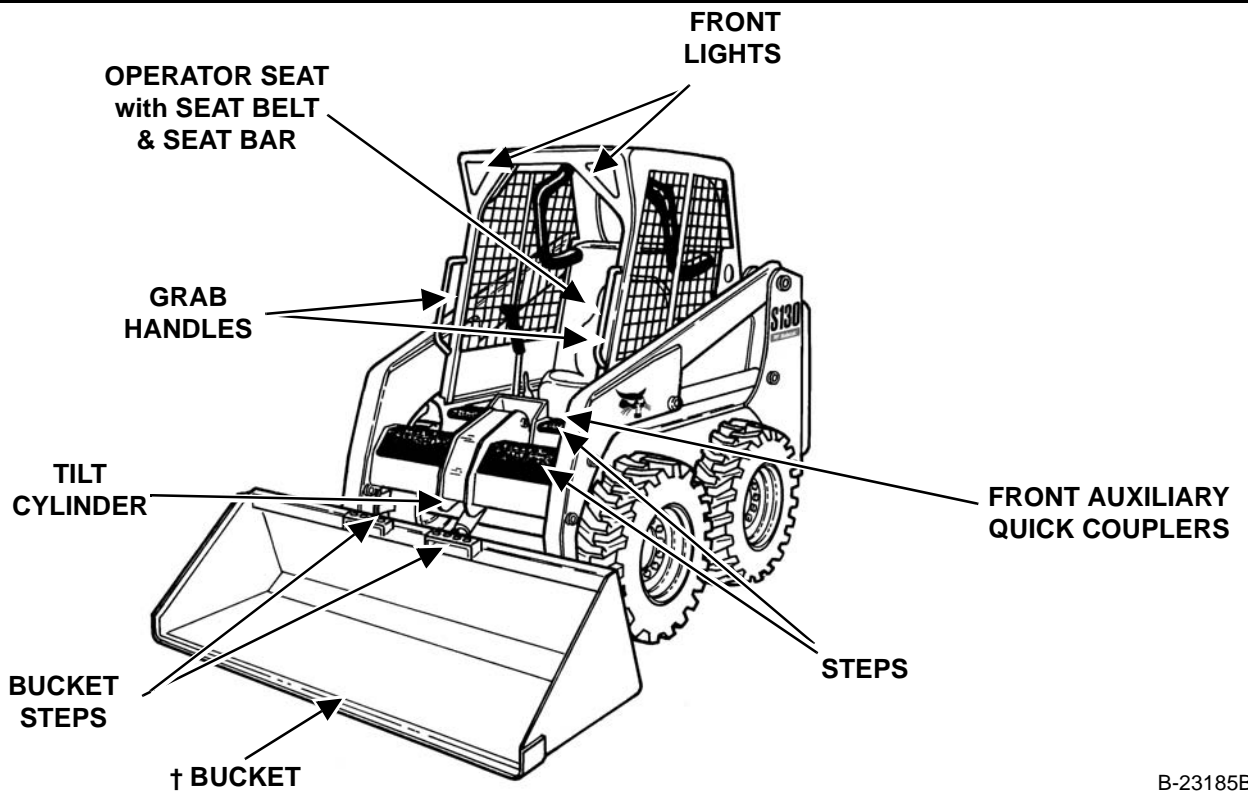

B-23185B

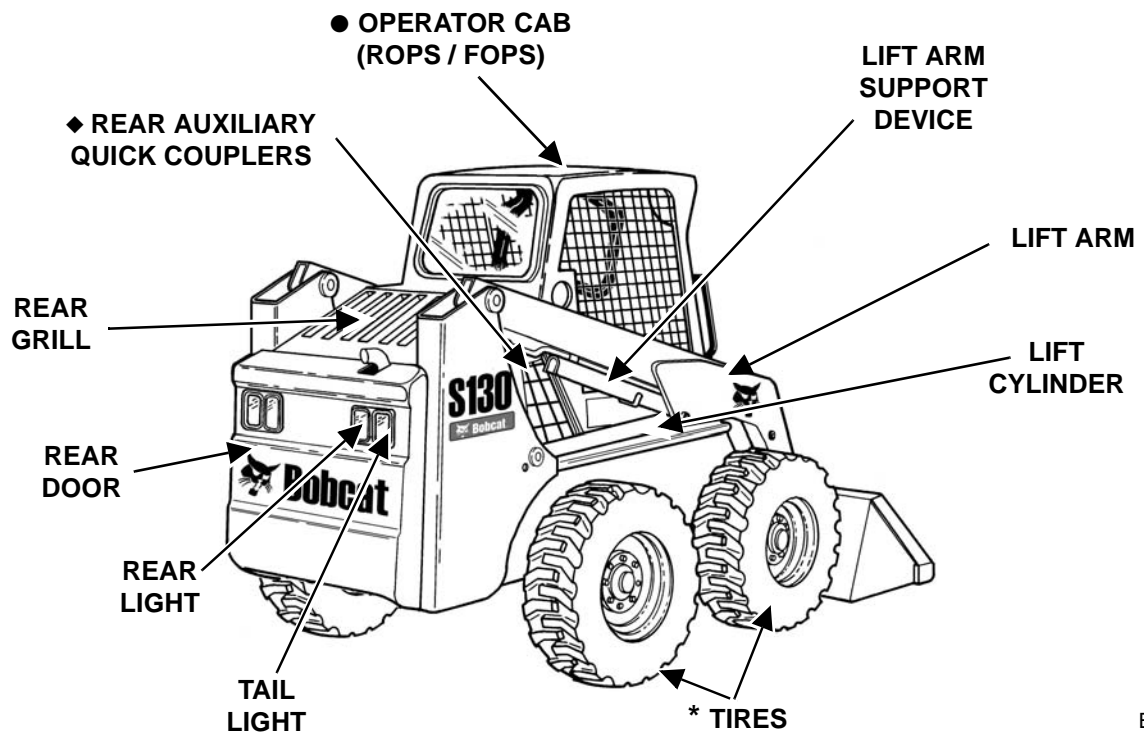

B-23186B

◆ Optional or Field Accessory (Not Standard Equipment)

\* TIRES - Tires shown may not be standard. The machine is factory equipped with standard tires. Other tires are available.

† Bucket - Several different buckets and other attachments are available for this machine.

● ROPS, FOPS - Roll Over Protective Structure, per ISO 3471, and Falling Object Protective Structure per ISO 3449, Level I, Level II is available.

## SAFETY AND MAINTENANCE

AIR CLEANER SERVICE . . . . .	10-80-1
Replacing Filter Elements . . . . .	10-80-1
BOB-TACH (HAND LEVER) . . . . .	10-140-1
Inspection And Maintenance . . . . .	10-140-1
BOB-TACH (POWER) . . . . .	10-141-1
Inspection And Maintenance . . . . .	10-141-1
ENGINE COOLING SYSTEM . . . . .	10-90-1
Checking Level . . . . .	10-90-1
Cleaning . . . . .	10-90-1
Removing And Replacing Coolant . . . . .	10-90-2
ENGINE LUBRICATION SYSTEM . . . . .	10-110-1
Checking And Adding Engine Oil . . . . .	10-110-1
Engine Oil Chart . . . . .	10-110-1
Removing And Replacing Oil And Filter . . . . .	10-110-2
FINAL DRIVE TRANSMISSION (CHAINCASE) . . . . .	10-130-1
Checking And Adding Oil . . . . .	10-130-1
Removing And Replacing Oil . . . . .	10-130-1
FUEL SYSTEM . . . . .	10-100-1
Filling The Fuel Tank . . . . .	10-100-2
Fuel Filter . . . . .	10-100-3
Fuel Specifications . . . . .	10-100-1
Removing Air From The Fuel System . . . . .	10-100-3
HYDRAULIC / HYDROSTATIC SYSTEM . . . . .	10-120-1
Breather Cap . . . . .	10-120-6
Checking And Adding Fluid . . . . .	10-120-1
Hydraulic / Hydrostatic Fluid Chart . . . . .	10-120-1
Removing And Replacing Case Drain Filters . . . . .	10-120-4
Removing And Replacing Hydraulic Charge Filter . . . . .	10-120-5
Removing And Replacing Hydraulic Fluid . . . . .	10-120-2
Removing And Replacing Hydraulic / Hydrostatic Filter . . . . .	10-120-3
LIFT ARM SUPPORT DEVICE . . . . .	10-20-1
Installing . . . . .	10-20-1
Removing . . . . .	10-20-2
LIFTING AND BLOCKING THE LOADER . . . . .	10-10-1
Procedure . . . . .	10-10-1

**Continued On Next Page**

## SAFETY AND MAINTENANCE (CONT'D)

LOADER STORAGE AND RETURN TO SERVICE . . . . .	10-190-1
Return to Service . . . . .	10-190-1
Storage . . . . .	10-190-1
LUBRICATING THE LOADER . . . . .	10-150-1
Lubrication Locations . . . . .	10-150-1
OPERATOR CAB . . . . .	10-30-1
Cab Door Sensor . . . . .	10-30-4
Description . . . . .	10-30-1
Lowering . . . . .	10-30-3
Raising . . . . .	10-30-2
Special Applications Kit . . . . .	10-30-4
Special Applications Kit Inspection And Maintenance . . . . .	10-30-4
PIVOT PINS . . . . .	10-180-1
Inspection And Maintenance . . . . .	10-180-1
REMOTE START TOOL KIT-MEL1563 . . . . .	10-60-1
Remote Start Procedure . . . . .	10-60-4
Remote Start Tool - MEL1563 . . . . .	10-60-1
Service Tool Harness Communicator - MEL1566 . . . . .	10-60-3
Service Tool Harness Control - MEL1565 . . . . .	10-60-2
REMOTE START TOOL (SERVICE TOOL) KIT - 6689779 . . . . .	10-61-1
Computer Service Tool Harness - 6689746 . . . . .	10-61-4
Description . . . . .	10-61-1
Loader Service Tool Harness - 6689747 . . . . .	10-61-3
Remote Start Procedure . . . . .	10-61-5
Remote Start Tool (Service Tool) - 6689778 . . . . .	10-61-2
SERVICE SCHEDULE . . . . .	10-70-1
Chart . . . . .	10-70-1
SPARK ARRESTOR MUFFLER . . . . .	10-170-1
Cleaning Procedure . . . . .	10-170-1
STOPPING THE ENGINE AND LEAVING THE LOADER . . . . .	10-200-1
Emergency Exit . . . . .	10-200-2
Procedure . . . . .	10-200-1
TIRE MAINTENANCE . . . . .	10-160-1
Mounting . . . . .	10-160-2
Rotating . . . . .	10-160-1
Wheel Nuts . . . . .	10-160-1
TOWING THE LOADER . . . . .	10-50-1
Procedure . . . . .	10-50-1

**Continued On Next Page**

**SAFETY AND MAINTENANCE (CONT'D)**

TRANSPORTING THE LOADER ON A TRAILER ..... 10-40-1  
    Fastening ..... 10-40-1  
    Loading And Unloading ..... 10-40-1

**TIGHTEN ALL HARDWARE PER SIZE TO GRADE 5 TORQUE (SEE  
STANDARD TORQUE SPECIFICATIONS FOR BOLTS, SECTION SPEC-01)  
UNLESS OTHERWISE SPECIFIED.**

## LIFTING AND BLOCKING THE LOADER

### Procedure

Figure 10-10-1

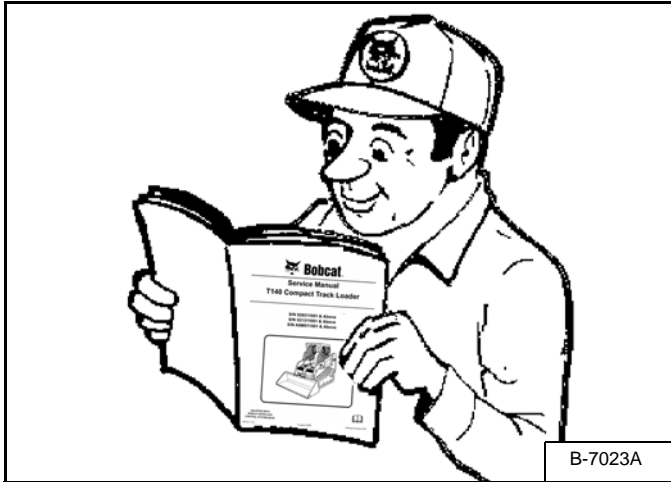

## WARNING

Instructions are necessary before operating or servicing machine. Read and understand the Operation & Maintenance Manual, Operator's Handbook and signs (decals) on machine. Follow warnings and instructions in the manuals when making repairs, adjustments or servicing. Check for correct function after adjustments, repairs or service. Untrained operators and failure to follow instructions can cause injury or death.

W-2003-0903

Always park the loader on a level surface.

## WARNING

Put jack stands under the front axles and rear corners of the frame before running the engine for service. Failure to use jack stands can allow the machine to fall or move and cause injury or death.

W-2017-0286

Figure 10-10-2



Put floor jack under the rear of the loader.

Lift the rear of the loader and install jack stands [Figure 10-10-2].

Figure 10-10-3

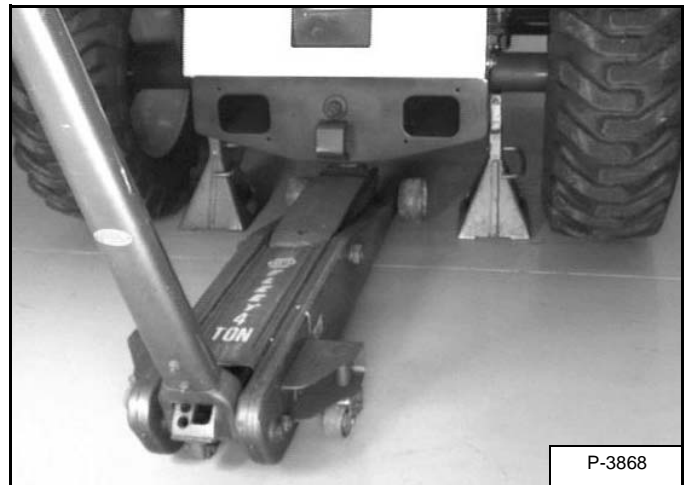

Put the floor jack under the front of the loader [Figure 10-10-3].

Lift the front of the loader and put jack stands under the axle tubes [Figure 10-10-3].

**NOTE:** Make sure the jack stands do not touch the tires. Make sure tires clear floor or any obstacles.

## LIFT ARM SUPPORT DEVICE

### Installing



Never work on a machine with the lift arms up unless the lift arms are secured by an approved lift arm support device. Failure to use an approved lift arm support device can allow the lift arms or attachment to fall and cause injury or death.

Service lift arm support device if damaged or if parts are missing. Using a damaged lift arm support or with missing parts can cause lift arms to drop causing injury or death.

W-2572-0407

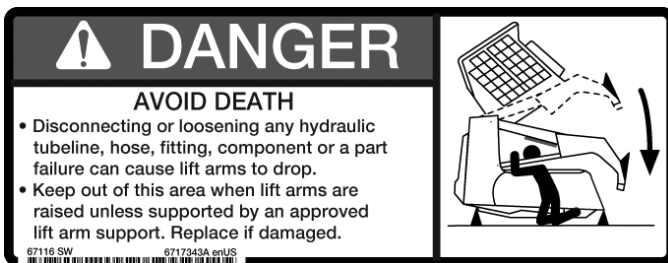

Remove attachment from the loader. (See Removal And Installation on Page 50-40-1.) **OR** (See Removal And Installation on Page 50-41-1.)

Figure 10-20-1

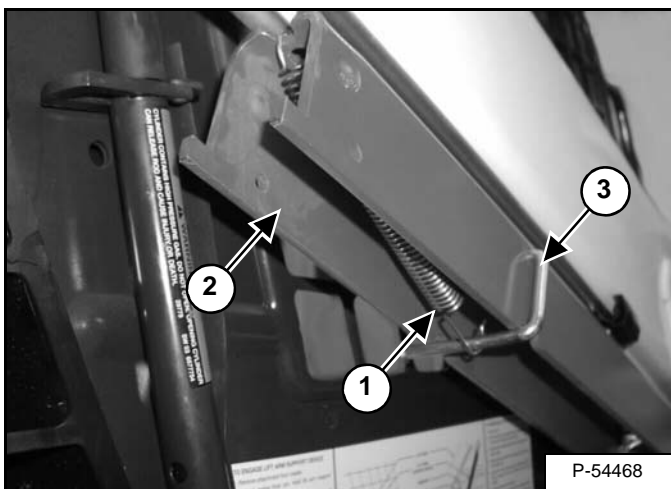

Put jackstands under the rear corners of the loader frame.

Disconnect the spring (Item 1) [Figure 10-20-1] from the lift arm support device retaining pin. Support the lift arm support device (Item 2) [Figure 10-20-1] with your hand and remove the retaining pin (Item 3) [Figure 10-20-1].

Figure 10-20-2

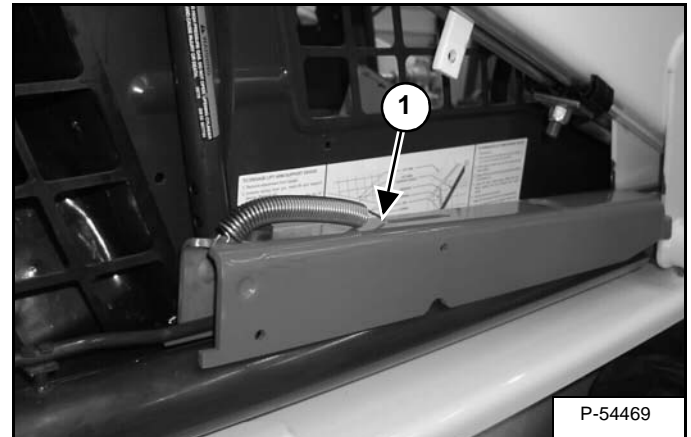

Lower the lift arm support device to the top of the lift cylinder. Hook the free end of the spring (Item 1) [Figure 10-20-2] to the lift arm support device so the spring does not interfere with the support device engagement.

Sit in the operator's seat, fasten the seat belt and lower the seat bar. Start the engine.

Figure 10-20-3

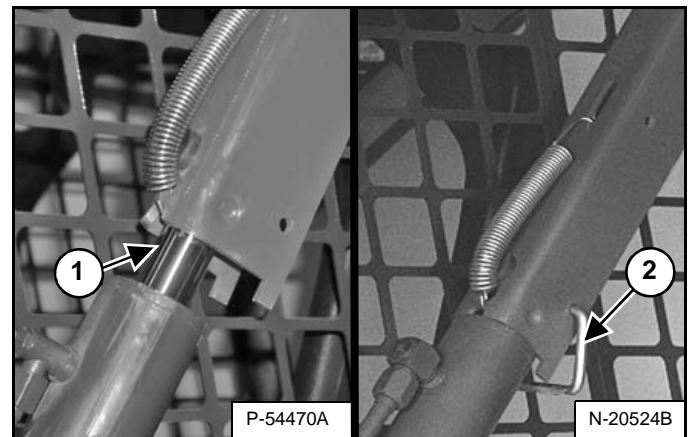

Raise the lift arms until the lift arm support device drops onto the lift cylinder rod (Item 1) [Figure 10-20-3].

Lower the lift arms slowly until the support device is held between the lift arm and the lift cylinder. Stop the engine. Raise the seat bar and move both pedals until both pedals lock.

Install pin (Item 2) [Figure 10-20-3] into the rear of the lift arm support device below the cylinder rod.

## LIFT ARM SUPPORT DEVICE (CONT'D)

### Removing

Remove the pin from the lift arm support device.

Figure 10-20-4

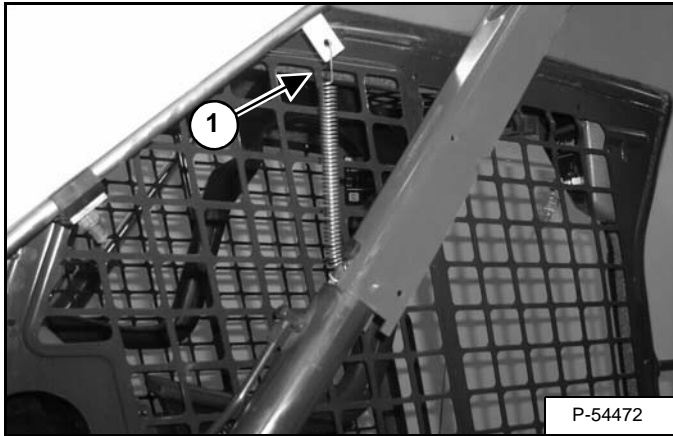

Connect the spring (Item 1) [Figure 10-20-4] from the lift arm support device to the bracket below the lift arms.

Sit in the operator's seat fasten the seat belt and lower the seat bar.

Start the engine.

Figure 10-20-5

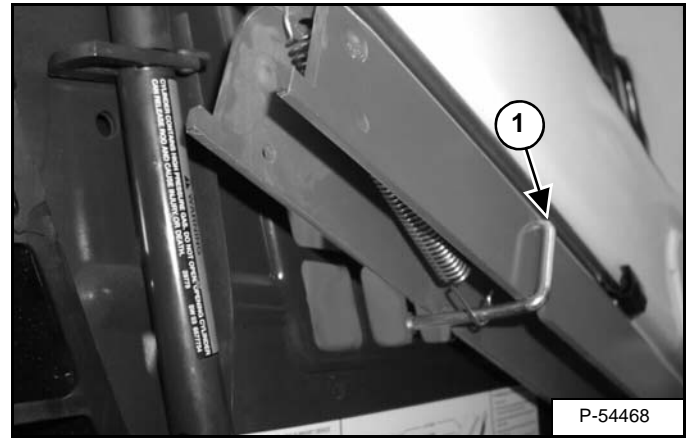

Raise the lift arms a small amount. The spring will lift the support device off the lift cylinder rod. Lower the lift arms. Stop the engine.

Raise the seat bar, disconnect the seat belt, move pedals until both pedals lock and exit the cab.

Disconnect the spring from the bracket.

Raise the support device into storage position and insert pin (Item 1) [Figure 10-20-5] through lift arm support device and bracket. Connect the spring to the pin.

Remove the jackstands.

## OPERATOR CAB

### Description

The Bobcat Loader has an operator cab (ROPS and FOPS) as standard equipment to protect the operator from rollover and falling objects. Check with your dealer if the operator cab has been damaged. The seat belt must be worn for rollover protection.

ROPS / FOPS - Roll Over protective Structure per ISO 3471, and Falling Object Protective Structure per SAE J1043 and ISO 3449, Level I. Level II is available.

*Level I* - Protection from falling bricks, small concrete blocks, and hand tools encountered in operations such as highway maintenance, landscaping, and other construction sites.

*Level II* - Protection from falling trees, rocks: for machines involved in site clearing, overhead demolition or forestry.



**Never modify operator cab by welding, grinding, drilling holes or adding attachments unless instructed to do so by Bobcat Company. Changes to the cab can cause loss of operator protection from rollover and falling objects, and result in injury or death.**

W-2069-0200

## OPERATOR CAB (CONT'D)

### Raising

Always stop the engine before raising or lowering the cab.

Stop the loader on a level surface. Lower the lift arms. If the lift arms must be up while raising the operator cab, install the lift arm support device. (See LIFT ARM SUPPORT DEVICE on Page 10-20-1.)

Figure 10-30-1

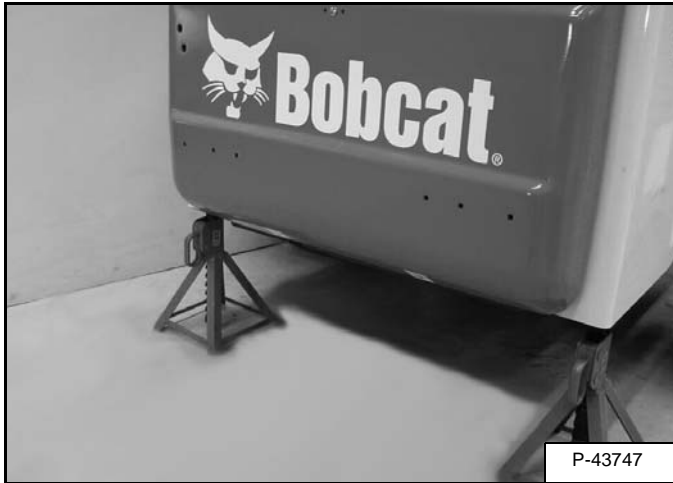

Install jackstands under the rear of the loader frame [Figure 10-30-1].

Figure 10-30-2

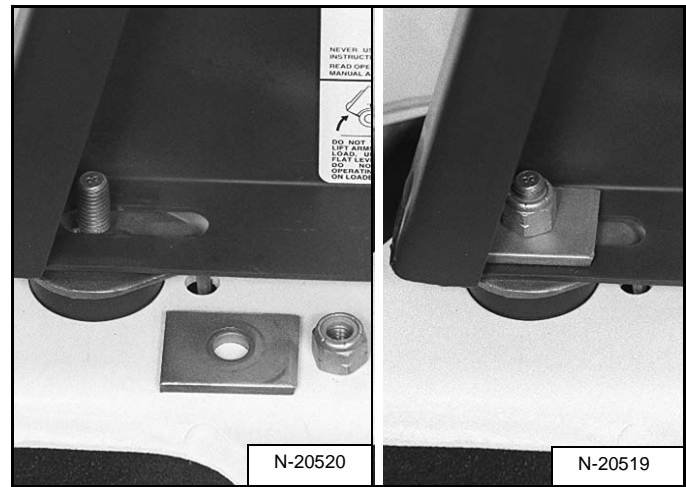

Remove the nuts and plates [Figure 10-30-2] (both sides) at the front corners of the cab.



**NOTE:** On Advanced Control System (ACS) equipped machines, the steering levers could contact the cab frame while raising or lowering the operator cab. The engine **MUST** be stopped before raising or lowering the cab.

## OPERATOR CAB (CONT'D)

### Raising (Cont'd)

Figure 10-30-3

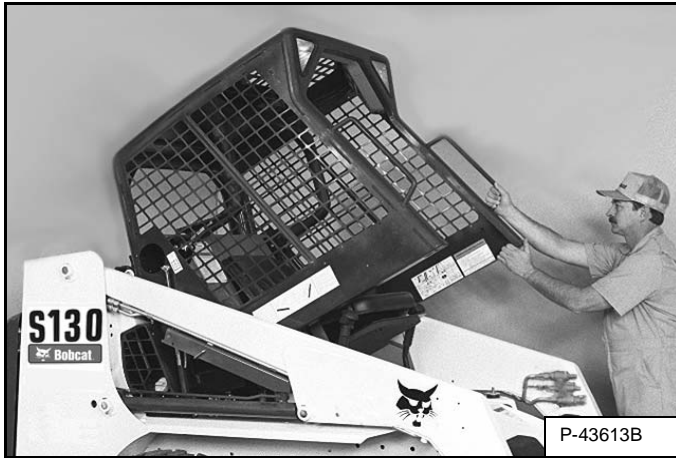

Lift on the grab handle and bottom of the operator cab slowly until the cab is all the way up and the latching mechanism engages [Figure 10-30-3].

### Lowering

Always stop the engine before raising or lowering the cab.

**NOTE:** Always use the grab handles to lower the cab.

Figure 10-30-4



Pull down on the bottom of the operator cab until it stops at the latching mechanism [Figure 10-30-4].

**NOTE:** The weight of the cab increases when equipped with options and accessories such as cab door, heater, air conditioning, etc. In these cases, the cab may need to be raised slightly from the latch to be able to release the latch.



**NOTE:** On Advanced Control System (ACS) equipped machines, the steering levers could contact the cab frame while raising or lowering the operator cab. The engine **MUST** be stopped before raising or lowering the cab.

Support the cab and release the latching mechanism (Inset) [Figure 10-30-4]. Remove your hand from latching mechanism when the cab is past the latch stop. Use both hands to lower the cab all the way.



**WARNING**  
PINCH POINT CAN CAUSE INJURY  
Remove your hand from the latching mechanism when the cab is past the latch stop.

W-2469-0803

Figure 10-30-5

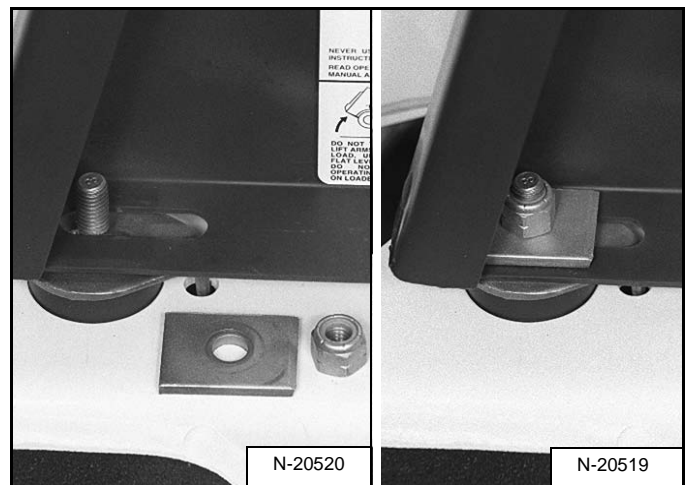

Install the plates and nuts (both sides) [Figure 10-30-5].

Tighten the nuts to 40-45 ft.-lb. (54-61 N•m) torque.

## OPERATOR CAB (CONT'D)

### Cab Door Sensor

This machine may be equipped with a Cab Door Sensor.

Figure 10-30-6

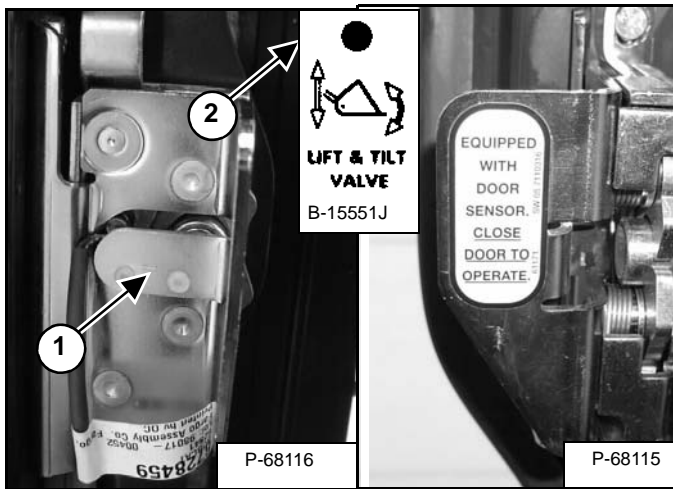

The cab door (option) has a sensor (Item 1) [Figure 10-30-6] installed which deactivates the lift and tilt valves when the door is open.

CLOSE DOOR TO OPERATE lift and tilt valves.

The LIFT & TILT VALVE light (Item 2) [Figure 10-30-6] will be ON when the door is closed and the PRESS TO OPERATE LOADER BUTTON is pressed.

### Special Applications Kit

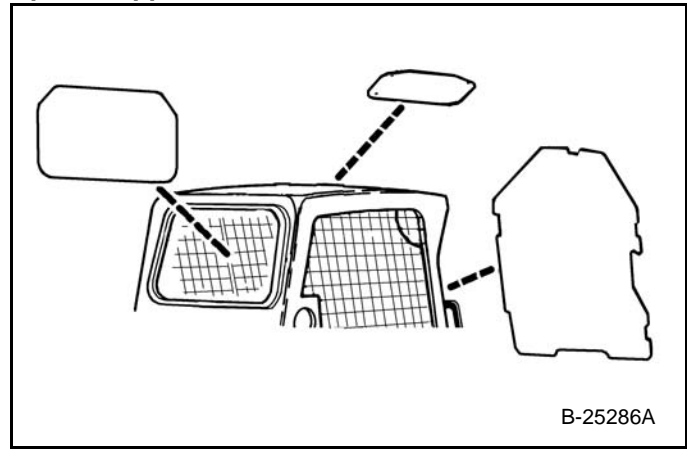

Available for special applications to restrict material from entering cab openings. Kit includes 1/2 inch polycarbonate front door, top and rear windows.

See your Bobcat dealer for availability.

### Special Applications Kit Inspection And Maintenance

- Inspect for cracks or damage. Replace if required.
- Pre-rinse with water to remove gritty materials.
- Wash with a mild household detergent and warm water.
- Use a sponge or soft cloth. Rinse well with water and dry with a clean soft cloth or rubber squeegee.
- Do not use abrasive or highly alkaline cleaners.
- Do not clean with metal blades or scrapers.

## TRANSPORTING THE LOADER ON A TRAILER

### Loading And Unloading



#### AVOID SERIOUS INJURY OR DEATH

Adequately designed ramps of sufficient strength are needed to support the weight of the machine when loading onto a transport vehicle. Wood ramps can break and cause personal injury.

W-2058-0807

Be sure the transport and towing vehicles are of adequate size and capacity. (See Capacities on Page SPEC-10-4.)

Figure 10-40-1

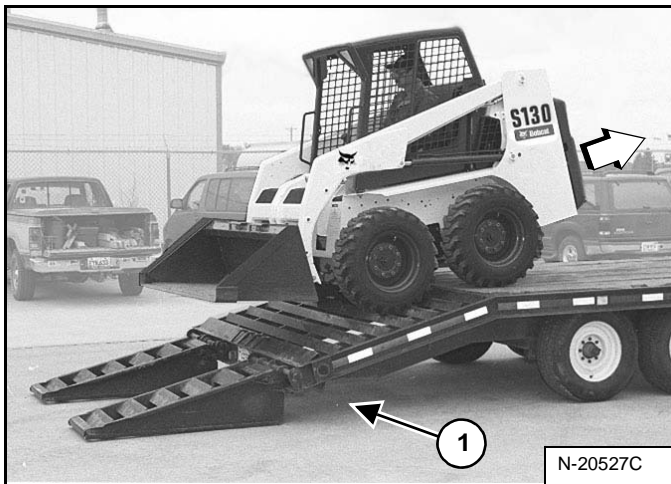

A loader with an empty bucket or no attachment must be loaded backward onto the transport vehicle [Figure 10-40-1].

The rear of the trailer must be blocked or supported (Item 1) [Figure 10-40-1] when loading or unloading the loader to prevent the front end of the trailer from raising up.

## Fastening

Figure 10-40-2

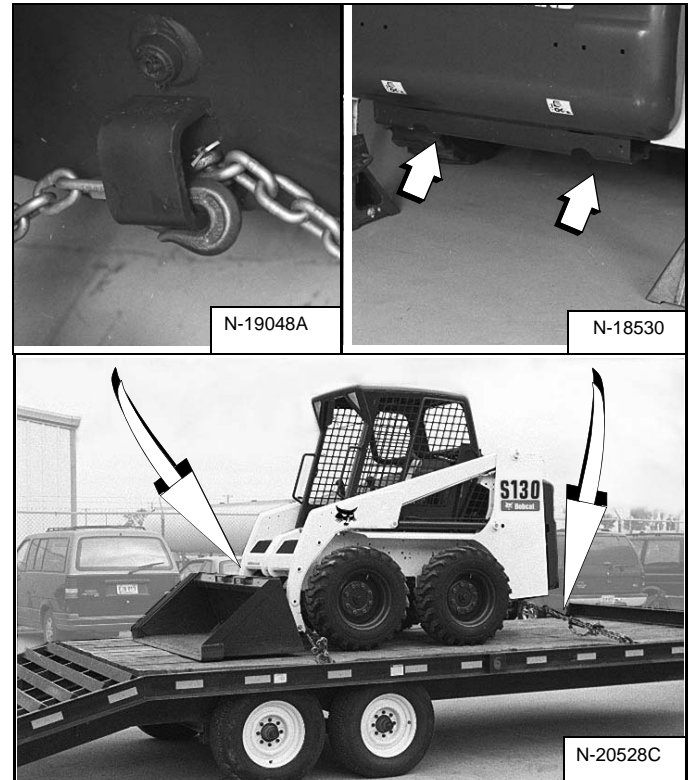

Use the following procedure to fasten the Bobcat Loader to the transport vehicle to prevent the loader from moving during sudden stops or when going up or down slopes [Figure 10-40-2].

- Lower the bucket or attachment to the floor.
- Stop the engine.
- Engage the parking brake.
- Install chains at the front and rear loader tie down positions (Inset) [Figure 10-40-2].
- Fasten each end of the chain to the transport vehicle.

## TOWING THE LOADER

### Procedure

Because of the design of the loader, there is not a recommended towing procedure.

- The loader can be lifted onto a transport vehicle.
- The loader can be skidded a short distance to move for service (EXAMPLE: Move onto a transport vehicle.) without damage to the hydrostatic system. (The tires/tracks will not turn.) There might be slight wear to the tires/tracks when the loader is skidded.

The towing chain (or cable) must be rated at 1 & 1/2 times the weight of the loader. (See Performance on Page SPEC-10-2.)



**Suggest:**

**If the above button click is invalid.**

**Please download this document**

**first, and then click the above link**

**to download the complete manual.**

**Thank you so much for reading**

## REMOTE START TOOL KIT-MEL1563

### Remote Start Tool - MEL1563

Tools that will be needed to complete the following steps are:

MEL1563 - Remote Start Tool

MEL1565 - Service Tool Harness Control

MEL1566 - Service Tool Harness Communicator (Computer Interface)

Figure 10-60-1

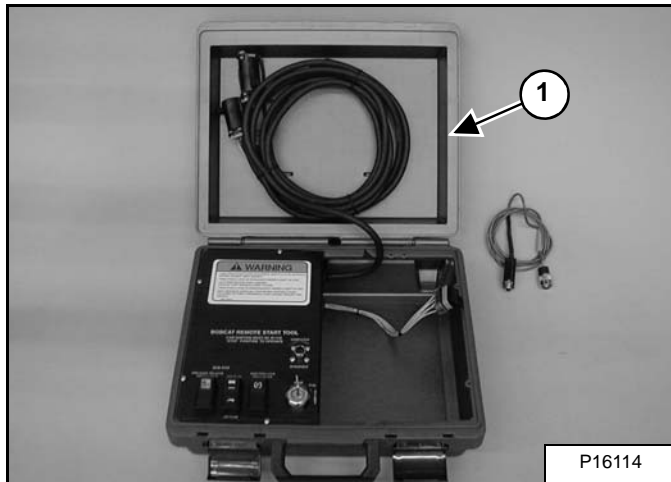

The remote start tool (Item 1) [Figure 10-60-1] is required when the service technician is checking the hydraulic/hydrostatic system or adjusting the steering linkage.

Figure 10-60-2

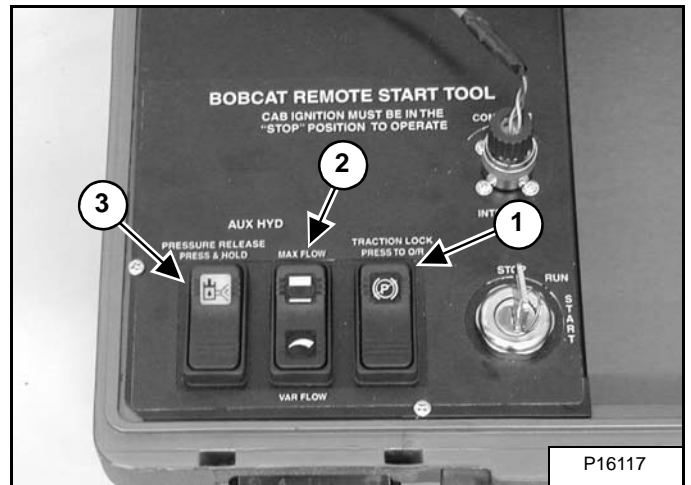

The traction lock switch (Item 1) [Figure 10-60-2] is used to turn traction lock ON or OFF. Push the switch to the override position. The switch will illuminate to indicate traction lock OVERRIDE, in this position the wheels are able to turn.

The maximum flow/variable flow switch (Item 2) [Figure 10-60-2] is used to activate the auxiliary hydraulics. Pressing the switch once will activate maximum flow. Pressing the switch again will activate variable flow. The switch will illuminate to indicate which flow rate is active. Pressing the switch a third time will turn the flow OFF. The switch is used when checking pressures and flow rate.

The auxiliary pressure release (Item 3) [Figure 10-60-2] is used to release hydraulic pressure to the front and/or rear auxiliary couplers. To release pressure; push and hold the switch for a few seconds.

**NOTE:** With the engine running; pushing and holding the pressure release switch will cause the engine to stop. To relieve the pressure; press the switch until the engine stops.

**<https://www.ebooklibonline.com>**

Hello dear friend!

Thank you very much for reading.

Enter the link into your browser.

The full manual is available for immediate download.

**<https://www.ebooklibonline.com>**