

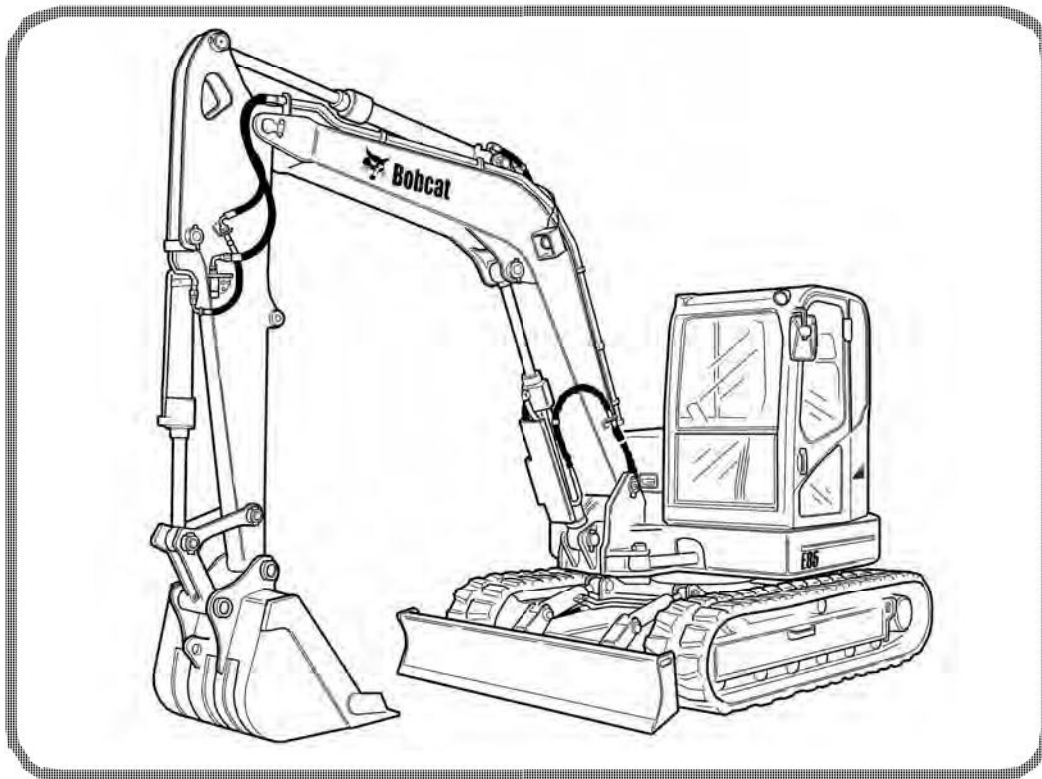

Bobcat®

Service Manual E85 Excavator

S/N B34T11001 & Above
S/N B34S11001 & Above



Dealer Copy -- Not for Resale



MAINTENANCE SAFETY



WARNING

Instructions are necessary before operating or servicing machine. Read and understand the Operation & Maintenance Manual, Operator's Handbook and signs (decals) on machine. Follow warnings and instructions in the manuals when making repairs, adjustments or servicing. Check for correct function after adjustments, repairs or service. Untrained operators and failure to follow instructions can cause injury or death.

W-2003-0807



Safety Alert Symbol: This symbol with a warning statement, means: "Warning, be alert! Your safety is involved!" Carefully read the message that follows.

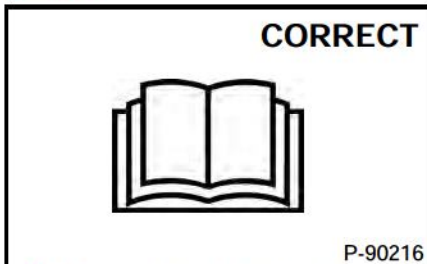

P-90216

⚠ Never service the Bobcat Excavator without instructions.

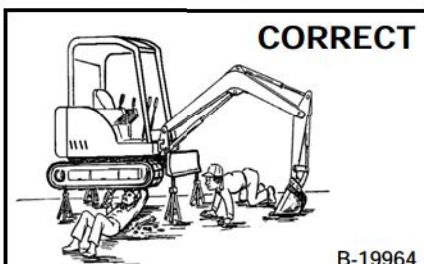

B-19964

⚠ Use the correct procedure to lift and support the excavator.

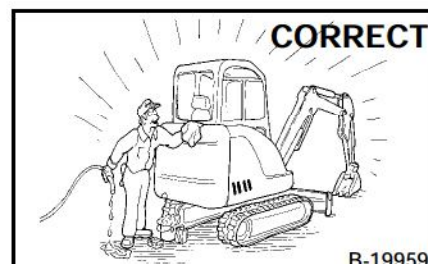

B-19959

⚠ Cleaning and maintenance are required daily.

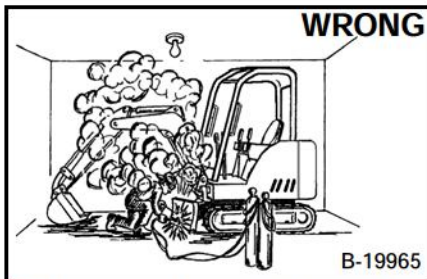

B-19965

⚠ Have good ventilation when welding or grinding painted parts.
⚠ Wear dust mask when grinding painted parts. Toxic dust and gas can be produced.

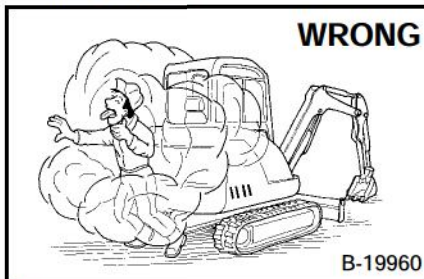

B-19960

⚠ Vent exhaust to outside when engine must be run for service.
⚠ Exhaust system must be tightly sealed. Exhaust fumes can kill without warning.

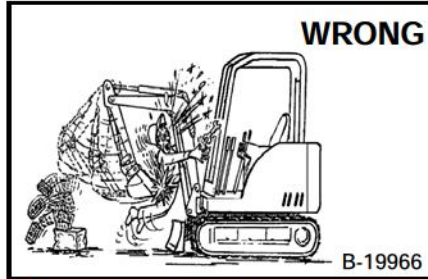

B-19966

⚠ Always lower the bucket and blade to the ground before doing any maintenance.
⚠ Never modify equipment or add attachments not approved by Bobcat Company.

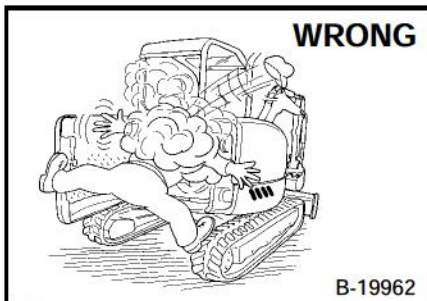

B-19962

⚠ Stop, cool and clean engine of flammable materials before checking fluids.
⚠ Never service or adjust machine with the engine running unless instructed to do so in the manual.
⚠ Avoid contact with leaking hydraulic fluid or diesel fuel under pressure. It can penetrate the skin or eyes.
⚠ Never fill fuel tank with engine running, while smoking, or when near open flame.

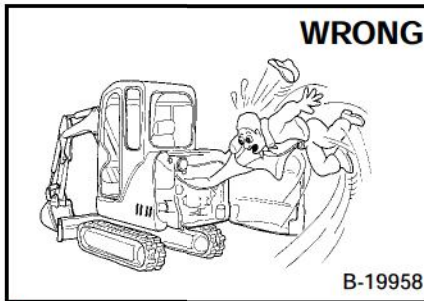

B-19958

⚠ Keep body, jewelry and clothing away from moving parts, electrical contact, hot parts and exhaust.
⚠ Wear eye protection to guard from battery acid, compressed springs, fluids under pressure and flying debris when engines are running or tools are used. Use eye protections approved for type of welding.
⚠ Keep tailgate closed except for service. Close and latch tailgate before operating the excavator.

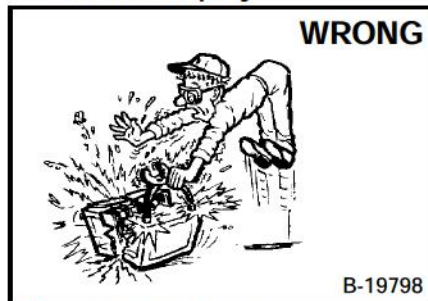

B-19798

⚠ Lead-acid batteries produce flammable and explosive gases.
⚠ Keep arcs, sparks, flames and lighted tobacco away from batteries.
⚠ Batteries contain acid which burns eyes or skin on contact.
⚠ Wear protective clothing. If acid contacts body, flush well with water. For eye contact flush well and get immediate medical attention.

Maintenance procedures which are given in the Operation & Maintenance Manual can be performed by the owner/operator without any specific technical training. Maintenance procedures which are **not** in the Operation & Maintenance Manual must be performed **ONLY BY QUALIFIED BOBCAT SERVICE PERSONNEL**. Always use genuine Bobcat replacement parts. The Service Safety Training Course is available from your Bobcat dealer.

MSW28-0409

Dealer Copy -- Not for Resale

CONTENTS

SAFETY AND MAINTENANCE	10-01
HYDRAULIC SYSTEM	20-01
UNDERCARRIAGE	30-01
UPPERSTRUCTURE AND SWING SECTION	40-01
ELECTRICAL SYSTEM AND ANALYSIS	50-01
ENGINE SERVICE	60-01
HEATING, VENTILATION AND AIR CONDITIONING (HVAC)	70-01
SPECIFICATIONS	SPEC-01
ALPHABETICAL INDEX	INDEX-01

Dealer Copy -- Not for Resale

FOREWORD

FOREWORD	1-7
SAFETY INSTRUCTIONS	1-9
FIRE PREVENTION	1-11
Maintenance	1-11
Operation	1-11
Electrical	1-11
Hydraulic System	1-11
Fueling	1-11
Starting	1-11
Spark Arrestor Exhaust System	1-11
Welding And Grinding	1-12
Fire Extinguishers	1-12
SERIAL NUMBER LOCATIONS	1-13
Excavator Serial Number	1-13
Engine Serial Number	1-13
DELIVERY REPORT	1-14
EXCAVATOR IDENTIFICATION	1-15

Dealer Copy -- Not for Resale

<https://www.ebooklibonline.com>

Hello dear friend!

Thank you very much for reading.

Enter the link into your browser.

The full manual is available for immediate download.

<https://www.ebooklibonline.com>

FOREWORD

This manual is for the Bobcat excavator mechanic. It provides necessary servicing and adjustment procedures for the Bobcat excavator and its component parts and systems. Refer to the Operation & Maintenance Manual for operating instructions, starting procedure, daily checks, etc.

A general inspection of the following items must be made after the excavator has had service or repair:

1. Check that the ROPS/TOPS/FOPS is in good condition and is not modified.



2. Check that ROPS/TOPS mounting hardware is tightened and is Bobcat approved.



3. The seat belt must be correctly installed, functional and in good condition.

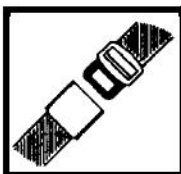

4. Machine signs (decals) must be legible and in the correct location.



5. Travel levers, control levers and foot pedals must return to neutral. Check that the pedal locks are in working order.

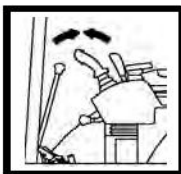

6. Check for correct function of the work lights.



7. Enclosure door latches must open and close freely.

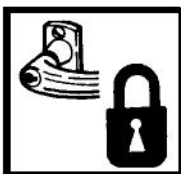

8. Attachment locking pins must function correctly and be in good condition.

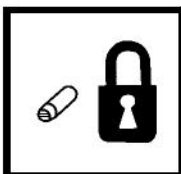

9. Safety treads must be in good condition.

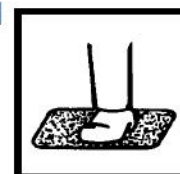

10. Check for correct function of indicator lamps.

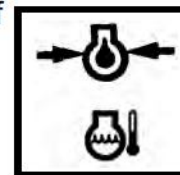

11. Check hydraulic fluid level, engine oil level and fuel supply.



12. Inspect for fuel, oil or hydraulic fluid leaks.

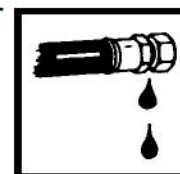

13. Lubricate the excavator.



14. Check the condition of the battery and cables.

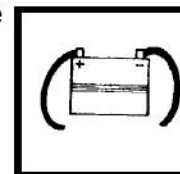

15. Inspect the air cleaner for damage or leaks. Check the condition of the element.

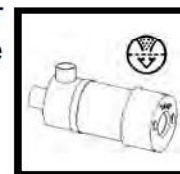

16. Check the electrical charging system.

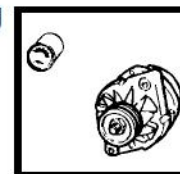

FW EXC-0509 SM

Dealer Copy -- Not for Resale

17. Check tracks for wear and tension. Use only approved tracks.

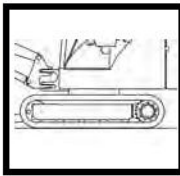

21. Check the control console interlocks for correct function.



18. Inspect for loose or broken parts or connections.



22. Inspect the X-Change™ for wear or damage. Repair or replace damaged parts.

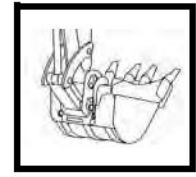

19. Check for any field modification not completed.



23. Check function or condition of all equipped options and accessories (examples: special applications kit, motion alarm, etc.).



20. Operate the machine and check all functions.



24. Recommend to the owner that all necessary corrections be made before the machine is returned to service.



**CALIFORNIA
PROPOSITION 65 WARNING**
Diesel engine exhaust and some of its constituents are known to the state of California to cause cancer, birth defects and other reproductive harm.

SAFETY INSTRUCTIONS



Safety Alert Symbol

This symbol with a warning statement means: "Warning, be alert! Your safety is involved!" Carefully read the message that follows.



WARNING

Instructions are necessary before operating or servicing machine. Read and understand the Operation & Maintenance Manual, Operator's Handbook and signs (decals) on machine. Follow warnings and instructions in the manuals when making repairs, adjustments or servicing. Check for correct function after adjustments, repairs or service. Untrained operators and failure to follow instructions can cause injury or death.

W-2003-0903

IMPORTANT

This notice identifies procedures which must be followed to avoid damage to the machine.

I-2019-0284



DANGER

The signal word DANGER on the machine and in the manuals indicates a hazardous situation which, if not avoided, will result in death or serious injury.

D-1002-1107



WARNING

The signal word WARNING on the machine and in the manuals indicates a potentially hazardous situation which, if not avoided, could result in death or serious injury.

W-2044-1107

The following publications provide information on the safe use and maintenance of the Bobcat machine and attachments:

- The Delivery Report is used to assure that complete instructions have been given to the new owner and that the machine is in safe operating condition.
- The Operation & Maintenance Manual delivered with the machine or attachment contains operating information as well as routine maintenance and service procedures. It is a part of the machine and can be stored in a container provided on the machine. Replacement Operation & Maintenance Manuals can be ordered from your Bobcat dealer.
- Machine signs (decals) instruct on the safe operation and care of your Bobcat machine or attachment. The signs and their locations are shown in the Operation & Maintenance Manual. Replacement signs are available from your Bobcat dealer.
- An Operator's Handbook fastened to the operator cab. It's brief instructions are convenient to the operator. The handbook is available from your dealer in an English edition or one of many other languages. See your Bobcat dealer for more information on translated versions.
- The AEM Safety Manual delivered with the machine gives general safety information.
- The Service Manual and Parts Manual are available from your dealer for use by mechanics to do shop-type service and repair work.
- The Compact Excavator Operator Training Course is available through your local dealer or at www.training.bobcat.com or www.bobcat.com. This course is intended to provide rules and practices of correct operation of the Bobcat excavator. The course is available in English and Spanish versions.
- Service Safety Training Courses are available from your Bobcat dealer or at www.training.bobcat.com or www.bobcat.com. They provide information for safe and correct service procedures.
- The Bobcat compact excavator Safety Video is available from your Bobcat dealer or at www.training.bobcat.com or www.bobcat.com.

Dealer Copy -- Not for Resale

SI EXC-0308 SM

FIRE PREVENTION



Maintenance

The machine and some attachments have components that are at high temperatures under normal operating conditions. The primary source of high temperatures is the engine and exhaust system. The electrical system, if damaged or incorrectly maintained, can be a source of arcs or sparks.

Flammable debris (leaves, straw, etc.) must be removed regularly. If flammable debris is allowed to accumulate, it can cause a fire hazard. Clean often to avoid this accumulation. Flammable debris in the engine compartment is a potential fire hazard.

The operator's area, engine compartment and engine cooling system must be inspected every day and cleaned if necessary to prevent fire hazards and overheating.

All fuels, most lubricants and some coolants mixtures are flammable. Flammable fluids that are leaking or spilled onto hot surfaces or onto electrical components can cause a fire.

Operation

Do not use the machine where exhaust, arcs, sparks or hot components can contact flammable material, explosive dust or gases.

Electrical



Check all electrical wiring and connections for damage. Keep the battery terminals clean and tight. Repair or replace any damaged part or wires that are loose or frayed.

Battery gas can explode and cause serious injury. Use the procedure in the Operation & Maintenance Manual for connecting the battery and for jump starting. Do not jump start or charge a frozen or damaged battery. Keep any open flames or sparks away from batteries. Do not smoke in battery charging area.

Hydraulic System

Check hydraulic tubes, hoses and fittings for damage and leakage. Never use open flame or bare skin to check for leaks. Hydraulic tubes and hoses must be properly routed and have adequate support and secure clamps. Tighten or replace any parts that show leakage.

Always clean fluid spills. Do not use gasoline or diesel fuel for cleaning parts. Use commercial nonflammable solvents.

Fueling



Stop the engine and let it cool before adding fuel. No smoking! Do not refuel a machine near open flames or sparks. Fill the fuel tank outdoors.

Starting

Do not use ether or starting fluids on any engine that has glow plugs. These starting aids can cause explosion and injure you or bystanders.

Use the procedure in the Operation & Maintenance Manual for connecting the battery and for jump starting.

Spark Arrestor Exhaust System

The spark arrestor exhaust system is designed to control the emission of hot particles from the engine and exhaust system, but the muffler and the exhaust gases are still hot.

Check the spark arrestor exhaust system regularly to make sure it is maintained and working properly. Use the procedure in the Operation & Maintenance Manual for cleaning the spark arrestor muffler (if equipped).

Dealer Copy - Not for Resale

FIRE PREVENTION (CONT'D)

Welding And Grinding

Always clean the machine and attachment, disconnect the battery, and disconnect the wiring from the Bobcat controllers before welding. Cover rubber hoses, battery and all other flammable parts. Keep a fire extinguisher near the machine when welding.

Have good ventilation when grinding or welding painted parts. Wear dust mask when grinding painted parts. Toxic dust or gas can be produced.

Dust generated from repairing nonmetallic parts such as hoods, fenders or covers can be flammable or explosive. Repair such components in a well ventilated area away from open flames or sparks.

Fire Extinguishers



Know where fire extinguishers and first aid kits are located and how to use them. Inspect the fire extinguisher and service the fire extinguisher regularly. Obey the recommendations on the instructions plate.

DELIVERY REPORT

Figure 3

The diagram shows a form titled "DELIVERY REPORT". The form is divided into several sections. At the top right, there is a box labeled "DELIVERY REPORT" containing several lines of text. Below this, on the left side, is a box labeled "WARNING" with a dark background and white text, followed by several lines of text. To the right of the "WARNING" box are several columns of text. At the bottom right of the form, there is a small box containing the text "B-16315".

The delivery report [Figure 3] must be completed by the dealer and signed by the owner or operator when the Bobcat excavator is delivered. An explanation of the form must be given to the owner.

EXCAVATOR IDENTIFICATION

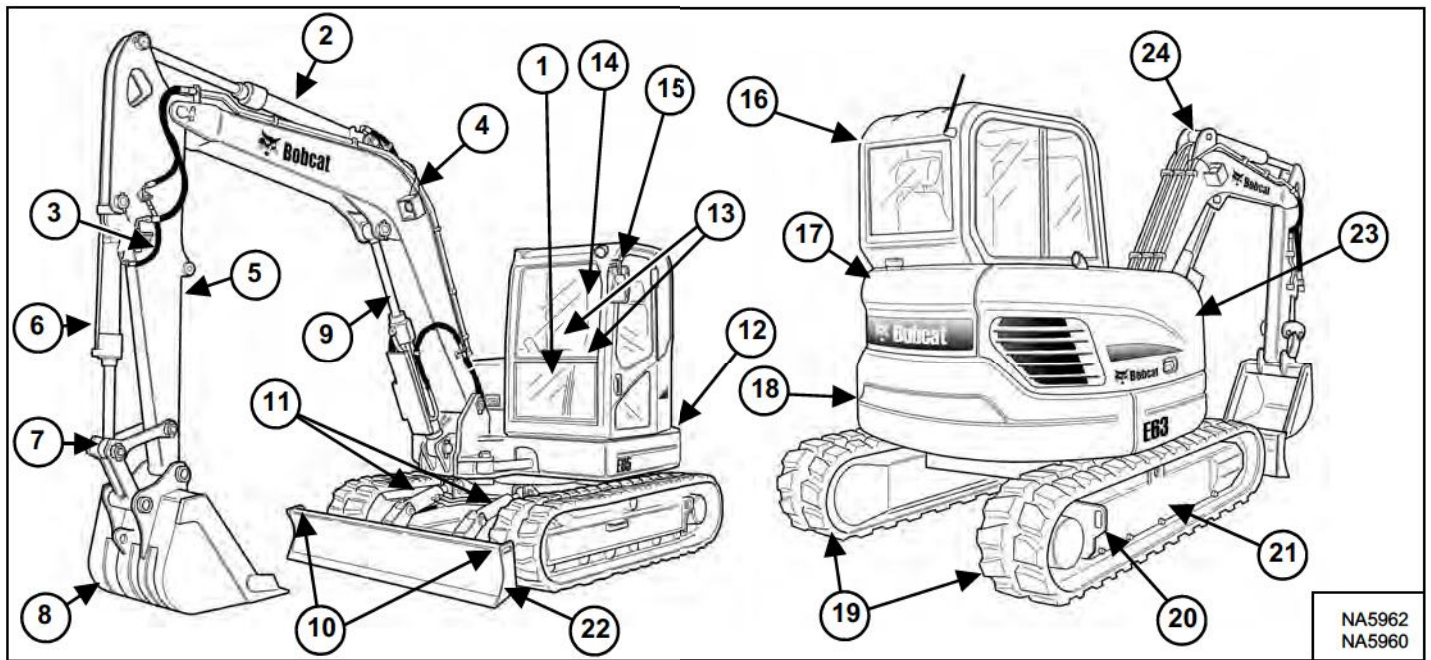

ITEM	DESCRIPTION	ITEM	DESCRIPTION
1	Operator's Handbook	16	Cab (ROPS / TOPS) [B]
2	Arm Cylinder	17	Rear Cover
3	Auxiliary Quick Couplers	18	Counterweight
4	Boom	19	Tracks [C]
5	Arm	20	Tie Downs (Both Sides)
6	Bucket Cylinder	21	Track Frames
7	Bucket Link	22	Blade
8	Bucket [A]	23	Right Side Cover
9	Boom Cylinder	24	Lift Point
10	Tie Downs / Lift Points		
11	Blade Cylinders		
12	Upperstructure		
13	Control Levers (Joysticks)		
14	Operator's Seat with Seat Belt		
15	Mirrors		

[A] BUCKET - Several different buckets and other attachments are available for the Bobcat excavator.

[B] ROPS - (Roll Over Protective Structure) as standard equipment.

The ROPS meets ISO 12117-2; 2008.

[C] TRACKS - Optional tracks are available.

Dealer Copy -- Not for Resale

SAFETY AND MAINTENANCE

LIFTING AND BLOCKING THE EXCAVATOR	10-10-1
Procedure	10-10-1
LIFTING THE EXCAVATOR	10-20-1
Procedure	10-20-1
OPERATOR CAB	10-30-1
Description	10-30-1
Cab Door	10-30-1
Front Window	10-30-2
Front Wiper	10-30-3
Window Washer Reservoir	10-30-3
Right Side Window	10-30-4
Heating, Ventilation And Air Conditioning Duct	10-30-5
TRANSPORTING THE EXCAVATOR ON A TRAILER	10-40-1
Loading And Unloading	10-40-1
Fastening	10-40-1
RIGHT SIDE COVER	10-50-1
Opening And Closing	10-50-1
Adjusting The Latch	10-50-1
REAR COVER	10-60-1
Opening And Closing	10-60-1
CENTER COVER	10-70-1
Opening And Closing	10-70-1
SERVICE SCHEDULE	10-80-1
Maintenance Intervals	10-80-1
AIR CLEANER SERVICE	10-90-1
Daily Check	10-90-1
Replacing The Filters	10-90-2
CAB FILTER	10-100-1
Cleaning And Maintenance	10-100-1
ENGINE COOLING SYSTEM	10-110-1
Cleaning	10-110-1
Checking Level	10-110-1
Removing And Replacing Coolant	10-110-2

Dealer Copy -- Not for Resale

FUEL SYSTEM	10-120-1
Fuel Specifications	10-120-1
Biodiesel Blend Fuel	10-120-1
Filling The Fuel Tank	10-120-2
Fuel Filters	10-120-3
Replacing Elements	10-120-3
Draining The Fuel Tank	10-120-5
Removing Air From The Fuel System	10-120-5
ENGINE LUBRICATION SYSTEM	10-130-1
Checking And Adding Engine Oil	10-130-1
Engine Oil Chart	10-130-1
Removing And Replacing Oil And Filter	10-130-2
HYDRAULIC SYSTEM	10-140-1
Checking And Adding Fluid	10-140-1
Hydraulic Fluid Chart	10-140-2
Removing And Replacing Hydraulic Filters	10-140-2
Removing And Replacing Hydraulic Fluid	10-140-6
Checking Swing Motor Gear Box Fluid Level	10-140-8
Removing And Replacing Swing Motor Gear Box Fluid	10-140-8
LUBRICATING THE EXCAVATOR	10-150-1
Lubrication Locations	10-150-1
PIVOT PINS	10-160-1
Inspection And Maintenance	10-160-1
TRAVEL MOTOR	10-170-1
Checking And Adding Oil	10-170-1
Removing And Replacing Oil	10-170-1
DIESEL PARTICULATE FILTER (DPF) SYSTEM	10-180-1
Description	10-180-1
Remote Parked Regeneration	10-180-1
Service Regeneration	10-180-3
DPF Cleaning	10-180-3
EMERGENCY EXIT	10-190-1
Right Rear Side Window	10-190-1
Front Window	10-190-1
SEAT BELT	10-200-1
Inspection And Maintenance	10-200-1
CAB TILT PROCEDURE	10-210-1
Raising And Lowering	10-210-1
CONTROL CONSOLE LOCKOUTS	10-220-1
Inspection And Maintenance	10-220-1

TOWING THE EXCAVATOR	10-230-1
Procedure	10-230-1

Dealer Copy -- Not for Resale

LIFTING AND BLOCKING THE EXCAVATOR

Procedure

Figure 10-10-1

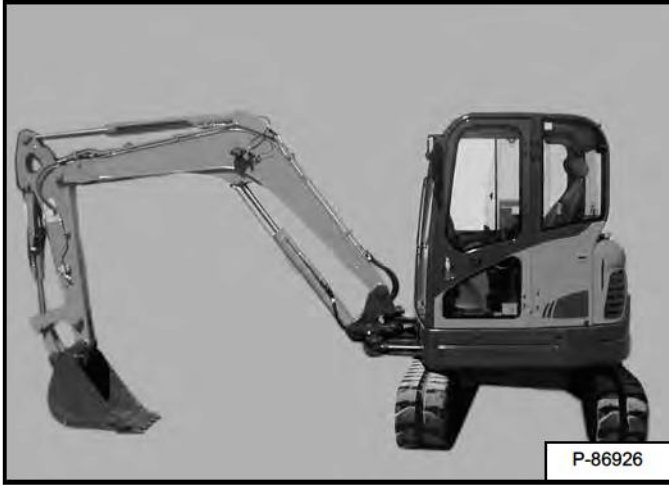

Raise one side of the machine (approximately 101,6 mm [4 in]) using the boom and arm [Figure 10-10-1].

Figure 10-10-2

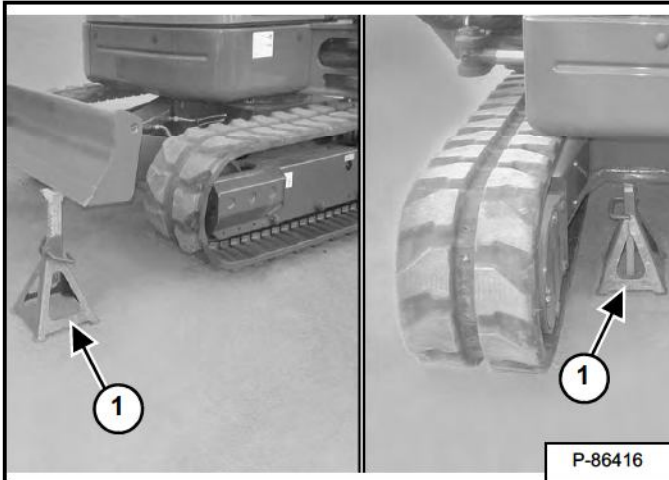

Fully raise the blade and install jackstands (Item 1) [Figure 10-10-2] under the blade and track frame. Lower the boom until all machine weight is on the jackstands.

Stop the engine.



AVOID INJURY

Keep fingers and hands out of pinch points when checking the track tension.

W-2142-0903



Put jackstands under the blade and rear corners of the undercarriage before working under the machine. Failure to block up the machine may allow it to move or fall and result in injury or death.

W-2218-1195

LIFTING THE EXCAVATOR

Procedure

Figure 10-20-1

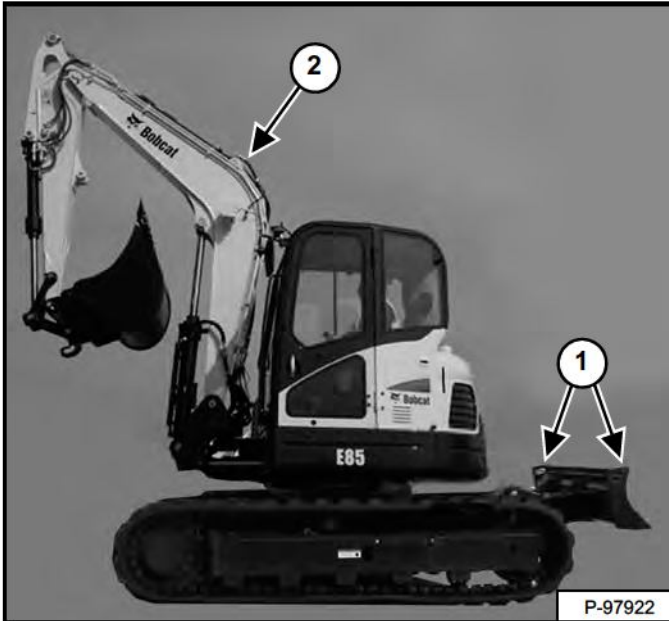

Fully extend the cylinders of the bucket, arm, and boom so that the excavator is in the position as shown [Figure 10-20-1].

Raise the blade fully.

Put all the control levers in neutral.

WARNING

AVOID INJURY OR DEATH

- Use a lifting fixture with sufficient capacity for the weight of the excavator plus any added attachments.
- Maintain center of gravity and balance when lifting.
- Do not swing boom or upperstructure.
- Never lift with operator on machine.

W-2434-0502

Figure 10-20-2

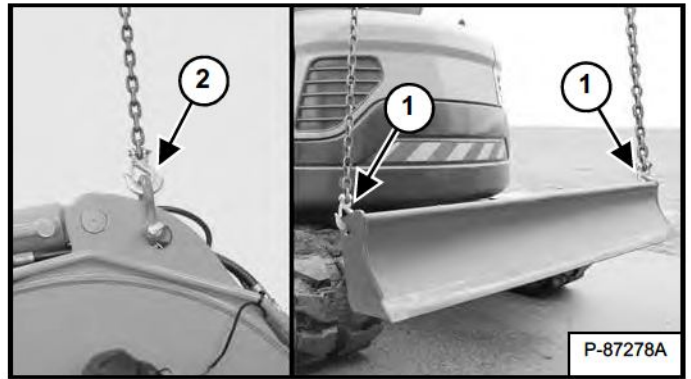

Fasten chains to the ends of the blade (Item 1) [Figure 10-20-1] and [Figure 10-20-2] and up to a lifting device above the cab. Place protective material between the chains and the cab and the upperstructure to prevent damage.

Fasten chains to the boom (Item 2) [Figure 10-20-1] and [Figure 10-20-2] and up to a lifting device above the cab. Place protective material between the chains and the cab and the upperstructure to prevent damage.

Figure 10-20-3

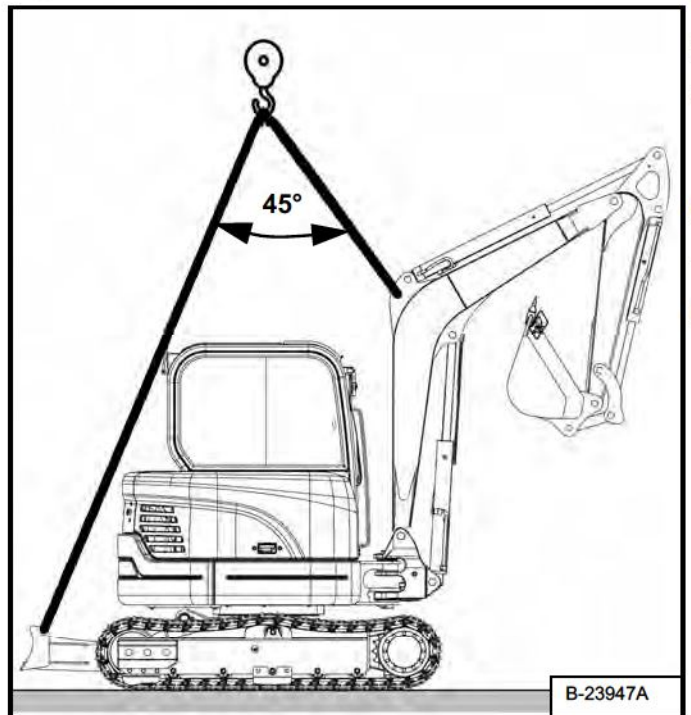

The maximum angle between the front and rear chains must not exceed 45° [Figure 10-20-3].

Dealer Copy -- Not for Resale

OPERATOR CAB

Description

The Bobcat excavator has an operator cab (ROPS) as standard equipment to provide protection if the excavator is tipped over. The seat belt must be worn for ROPS protection.

Check the ROPS cab, mounting, and hardware for damage. Never modify the ROPS cab. Replace the cab and hardware if damaged. See your Bobcat dealer for parts.

ROPS - Roll Over Protective Structure per ISO 12117-2: 2008.

WARNING

Never modify operator cab by welding, grinding, drilling holes or adding attachments unless instructed to do so by Bobcat Company. Changes to the cab can cause loss of operator protection from rollover and falling objects, and result in injury or death.

W-2069-0200

Cab Door

Figure 10-30-1

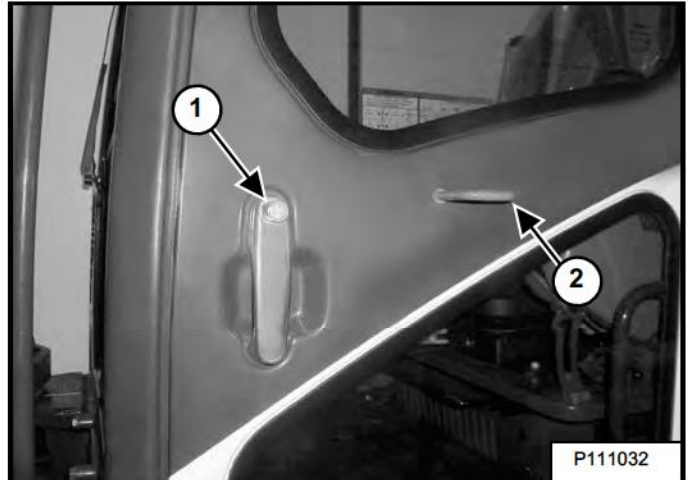

The cab door can be locked (Item 1) [Figure 10-30-1] with the same key as the starter switch.

The door can be held in the open position. Push the door all the way open until the latch (Item 2) [Figure 10-30-1] engages to hold the door in the open position.

Figure 10-30-2

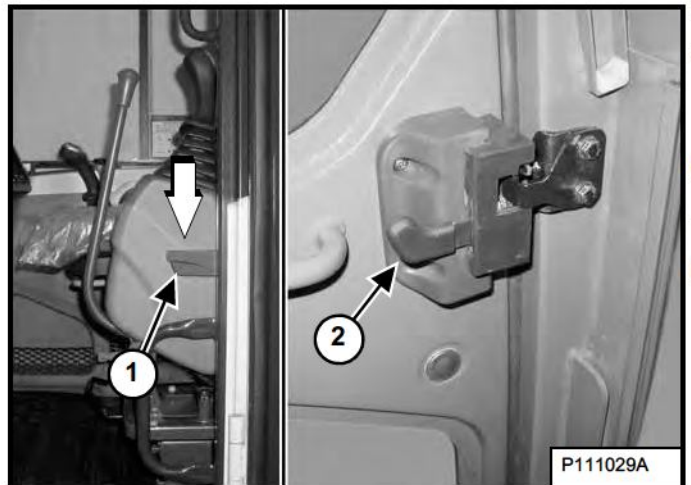

When the door is in the open position, push down on the latch (Item 1) [Figure 10-30-2] and close the door.

From inside the cab, open the door using the handle (Item 2) [Figure 10-30-2].

Dealer Copy -- Not for Resale

OPERATOR CAB (CONT'D)

Front Window

Opening The Front Window

Figure 10-30-3

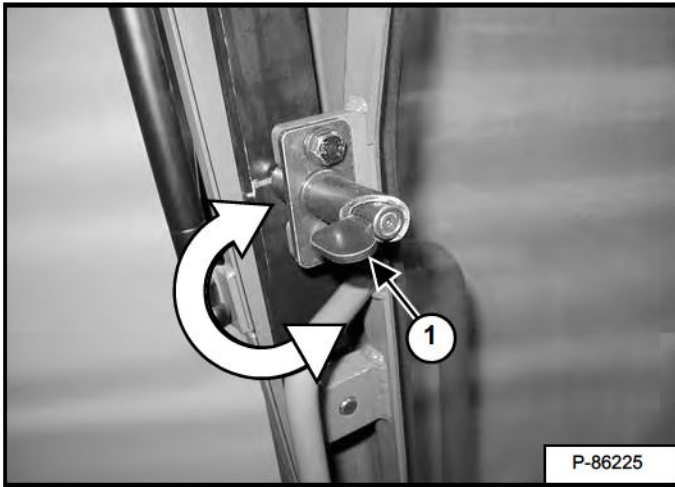

Rotate the front window latch pins (Item 1) [Figure 10-30-3] (Both sides).

Figure 10-30-4



Use both window grab handles to pull the top of the window in [Figure 10-30-4].

Continue moving the window in and up over the operator's head until the window is fully raised.

Figure 10-30-5

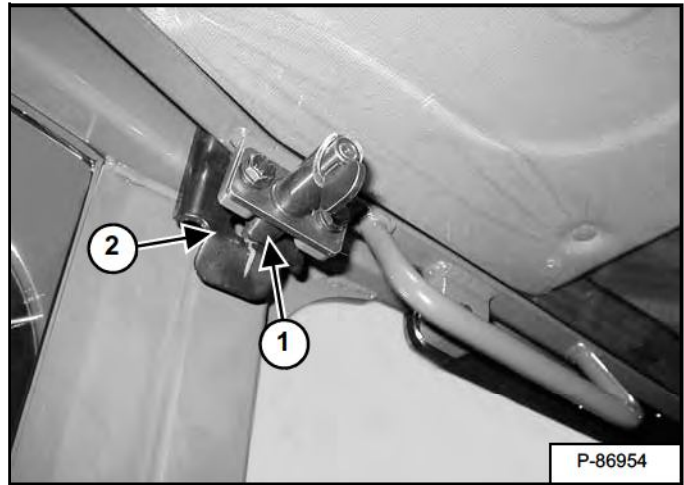

When the window is fully raised, push up on the window slightly until the two latch pins (Item 1) (both sides) engage into the bracket (Item 2) [Figure 10-30-5] to lock the window in the open position. Pull down slightly on the window to make sure the latch pins are properly seated to hold the window securely in the open position.

Closing The Front Window

Support the window while rotating both window latch pins (Item 1) [Figure 10-30-5] to the unlocked position.

Using both window grab handles, pull the window forward and down to the closed position [Figure 10-30-4].

When the window is fully lowered, push in on the window slightly until the two latch pins (Item 1) [Figure 10-30-3] (both sides) engage into the bracket to lock the window in the closed position.

OPERATOR CAB (CONT'D)

Front Wiper

Figure 10-30-6



The front window is equipped with a wiper (Item 1) [Figure 10-30-6] and washer.

Figure 10-30-7

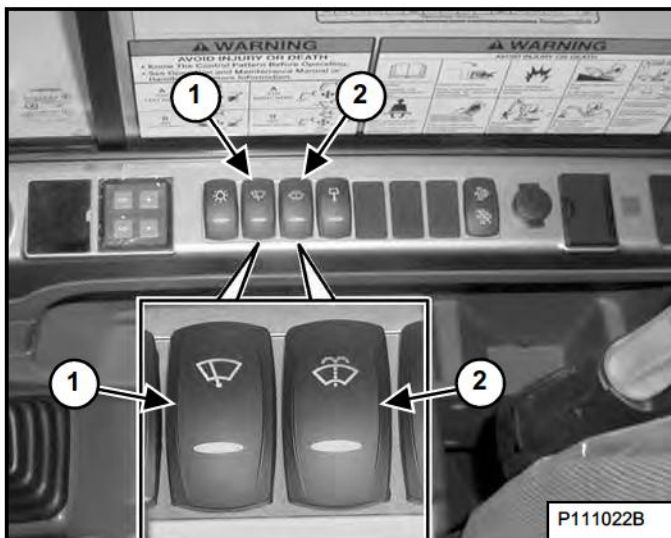

The wiper switch (Item 1) [Figure 10-30-7] has three positions, OFF, intermittent wiper mode and full speed.

The window washer switch (Item 2) activates the front window washer. (The wiper switch (Item 1) must be activated before the washer switch (Item 2) [Figure 10-30-7] will allow washer fluid to be sprayed on the front window.)

Window Washer Reservoir

Figure 10-30-8

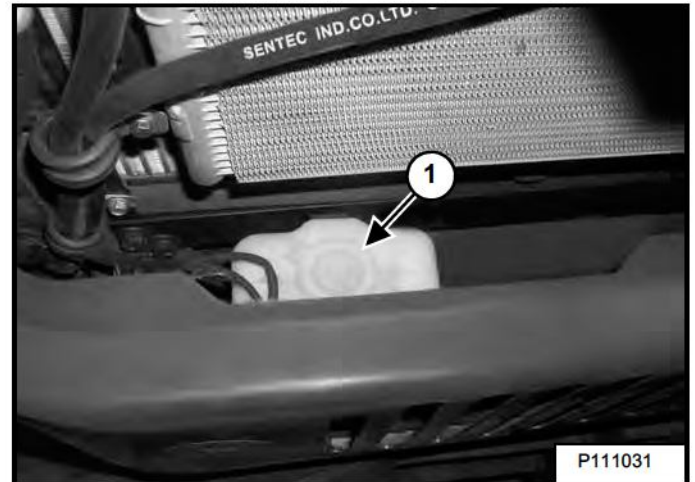

The window washer reservoir (Item 1) [Figure 10-30-8] is located under the right side cover. (When the temperature is 0°C (32°F) or lower, fill the washer reservoir with washer fluid specified for freezing conditions. If the washer bottle is filled with water, it will freeze and damage the washer reservoir.)

Dealer Copy -- Not for Resale

OPERATOR CAB (CONT'D)

Right Side Window

Opening The Right Front Window

Figure 10-30-9

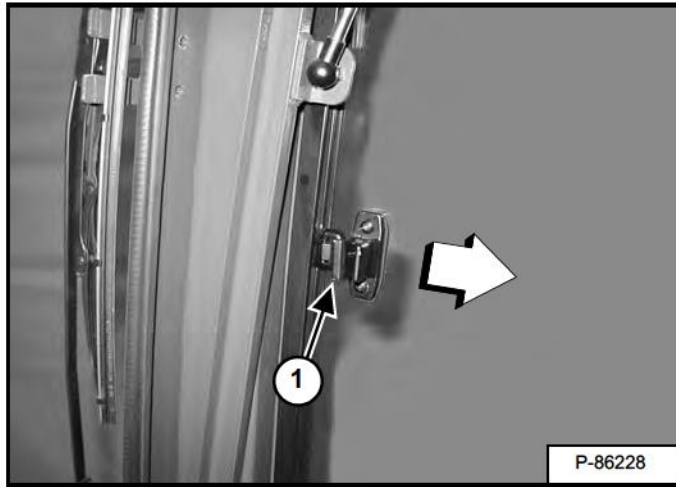

Press the latch / handle (Item 1) **[Figure 10-30-9]** together and pull back on the latch / handle to open the right side window.

Closing The Right Front Window

Push the latch / handle (Item 1) **[Figure 10-30-9]** forward until the latch / handle lock the window in the closed position.

OPERATOR CAB (CONT'D)

Heating, Ventilation And Air Conditioning Duct

Figure 10-30-10

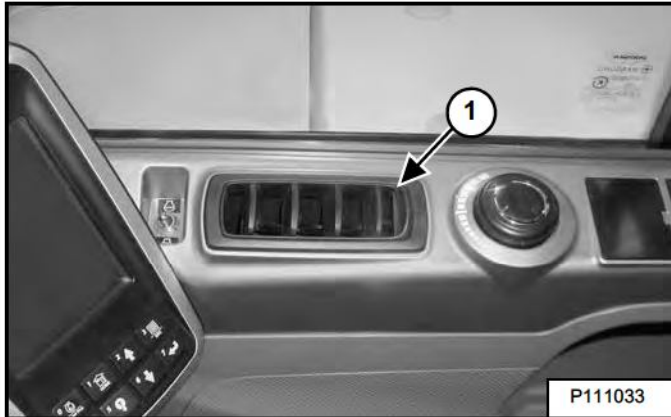

Figure 10-30-11

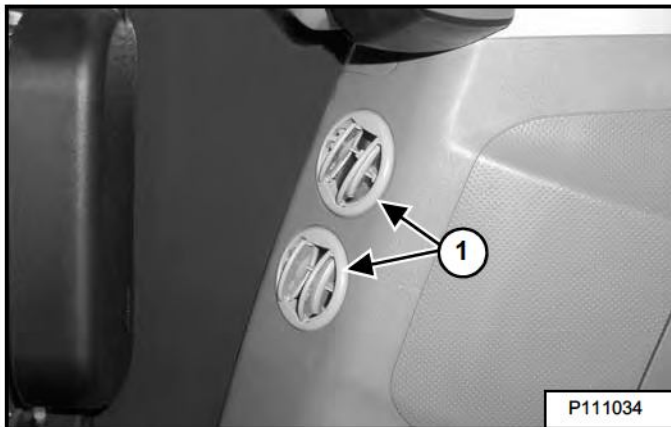
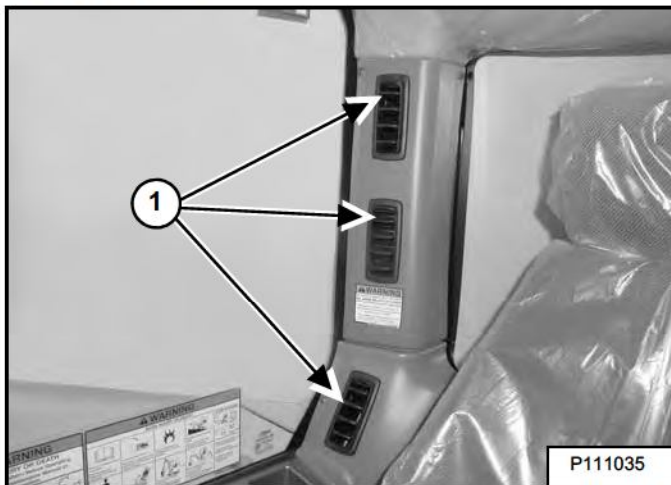
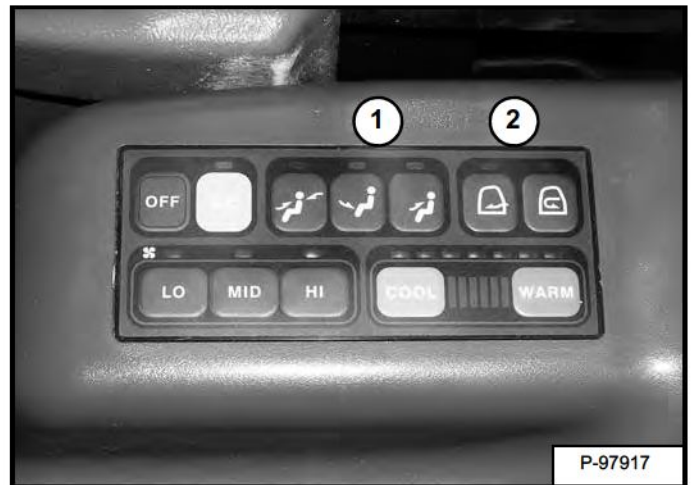

Figure 10-30-12



The excavator is equipped with seven air vents (Item 1) [Figure 10-30-10], [Figure 10-30-11] and [Figure 10-30-12] that can be adjusted to deflect air flow to the desired area of the cab.

Figure 10-30-13



Use one of the three buttons (Item 1) located in the left console to control which air ducts are active and two buttons (Item 2) [Figure 10-30-13] that control fresh air or recirculated air.

Operating Tip: To increase heating or cooling efficiency, move the Recirculation / Fresh Air Control (Item 2) [Figure 10-30-13] to the recirculation position. This will allow the air to recirculate through the HVAC system and improve temperature control. If left in the fresh air position, the HVAC system will also need to heat or cool the ambient air that is drawn in from the outside, slowing and / or reducing the temperature change inside the cab.

Dealer Copy -- Not for Resale

TRANSPORTING THE EXCAVATOR ON A TRAILER

Loading And Unloading

When transporting the machine, observe the rules, motor vehicle laws, and vehicle limit ordinances. Use a transport and towing vehicle of adequate length and capacity.

Secure the parking brakes and block the wheels of the transport vehicle.

Align the ramps with the center of the transport vehicle. Secure the ramps to the truck bed and be sure ramp angle does not exceed 15 degrees.

Use metal loading ramps with a slip resistant surface.

Use ramps that are the correct length and width and can support the weight of the machine.

The rear of the trailer must be blocked or supported when loading or unloading the machine to prevent the front of the transport vehicle from raising.

Determine the direction of the track movement before moving the machine (blade forward).

Figure 10-40-1



NOTE: When loading or unloading the machine, disengage the auto idle feature and place the two-speed travel in low range.

Move the machine forward onto the transport vehicle [Figure 10-40-1].

Do not change direction of the machine while it is on the ramps.

Lower the boom, arm, bucket, and blade to the transport vehicle.

Stop the engine and remove the key.

Put blocks at the front and rear of the tracks.

Fastening

Figure 10-40-2

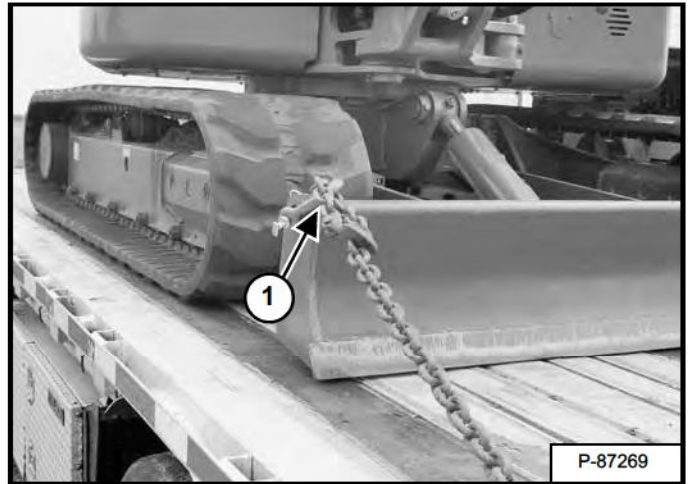
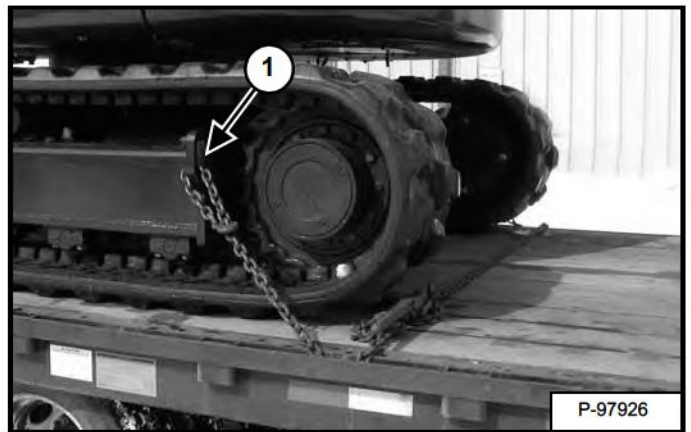

Figure 10-40-3



Fasten chains to both corners of the blade (Item 1) [Figure 10-40-2] (both sides) and to the tie down loop at the rear of the track frame (Item 1) [Figure 10-40-3] (both sides) to prevent it from moving when going up or down slopes or during sudden stops.

Use chain binders to tighten the chains and then safely tie the chain binder levers to prevent loosening.



AVOID SERIOUS INJURY OR DEATH
Adequately designed ramps of sufficient strength are needed to support the weight of the machine when loading onto a transport vehicle. Wood ramps can break and cause personal injury.

W-2058-0807

Dealer Copy -- Not for Resale

RIGHT SIDE COVER

Opening And Closing

Figure 10-50-1

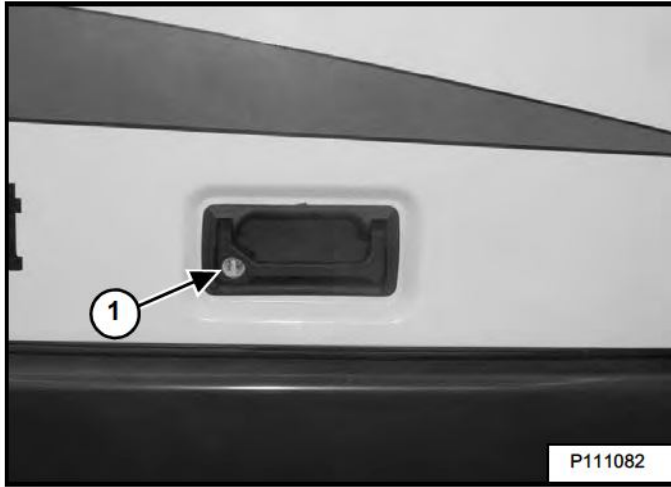

Use the start key (Item 1) [Figure 10-50-1] to unlock the latch.

Pull the latch (Item 1) [Figure 10-50-1] and raise the right side cover.

Close and lock the center cover when the service procedure is completed.

Adjusting The Latch

Figure 10-50-2

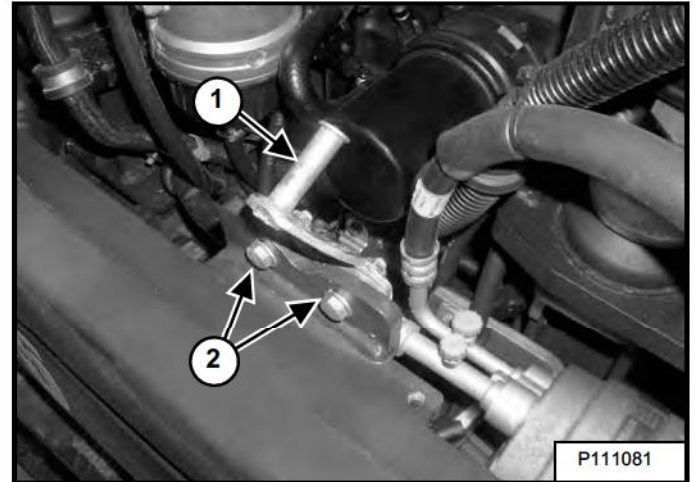

The right side cover latch (Item 1) [Figure 10-50-2] can be adjusted.

Loosen the bolts and nuts (Item 2) [Figure 10-50-2] and adjust the latch. Tighten the nuts after the adjustment is made.

Close the right side cover before operating the excavator.

Dealer Copy -- Not for Resale

REAR COVER

Opening And Closing

The hydraulic tank breather / filter and hydraulic oil fill cover is located under the rear cover.

Figure 10-60-1

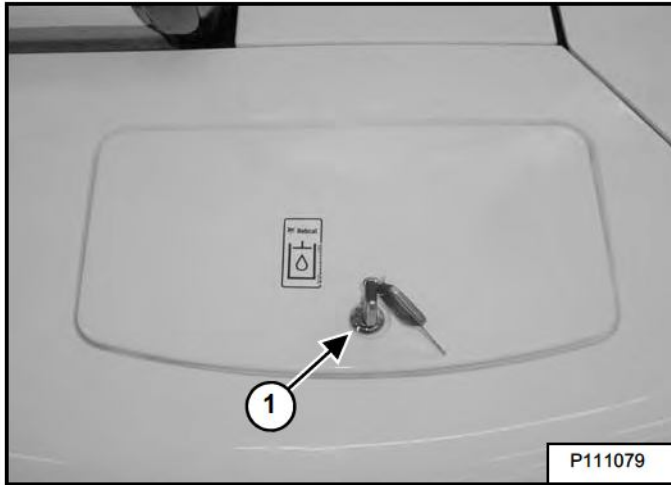

Use the start key to unlock and open the rear cover (Item 1) [Figure 10-60-1].

Close and lock the rear cover when the service procedure is completed.

CENTER COVER

Opening And Closing

The battery, circuit breaker, fusible links, some relays and the swing motor are located under the center cover.

Figure 10-70-1

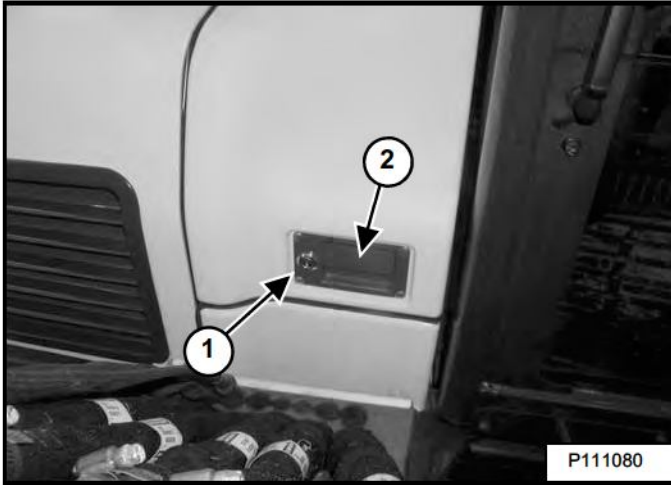

Use the start key (Item 1) [Figure 10-70-1] to unlock the latch.

Pull the latch (Item 2) [Figure 10-70-1] and raise the cover.

Close and lock the center cover when the service procedure is completed.



Suggest:

If the above button click is invalid.

Please download this document

first, and then click the above link

to download the complete manual.

Thank you so much for reading

SERVICE SCHEDULE

Maintenance Intervals

Maintenance work must be done at regular intervals. Failure to do so will result in excessive wear and early failures.

The service schedule is a guide for correct maintenance of the Bobcat loader.



AVOID INJURY OR DEATH

Instructions are necessary before operating or servicing machine. Read and understand the **Operation & Maintenance Manual, Operator's Handbook** and signs (decals) on machine. Follow warnings and instructions in the manuals when making repairs, adjustments or servicing. Check for correct function after adjustments, repairs or service. Untrained operators and failure to follow instructions can cause injury or death.

W-2003-0807

Every 10 Hours (Before Starting The Loader)

- **Engine Oil** - Check level and add as needed.
- **Engine Air Filters and Air System** - Check display panel. Service only when required. Check for leaks and damaged components.
- **Engine Cooling System** - Check coolant level COLD and add premixed coolant as needed.
- **Fuel Filter** - Check display panel. Remove the trapped water when required.
- **Seat Belt, Seat Belt Retractors, Seat Belt Mounting hardware, Control Console Lockout** - Check the condition of seat belt and mounting hardware. Clean or replace seat belt retractors as needed. Check the control console lockout lever for proper operation. Clean dirt and debris from moving parts.
- **Motion Alarm** - Check for proper function.
- **Operator Cab** - Check the cab condition and mounting hardware.
- **Indicators and Lights** - Check for correct operation of all indicators and lights.
- **Safety Signs** - Check for damaged signs (decals). Replace any signs that are damaged.
- **Hydraulic Fluid** - Check fluid level and add as needed.
- **Track Tension** - Check tension and adjust as needed.
- **Swing Reduction Gearbox** - Check fluid level and add as needed.

Every 50 Hours

- **Hydraulic Hoses and Tubelines** - Check for damage and leaks. Repair or replace as needed.
- **Steering Levers and Joysticks** - Check for correct operation. Repair as needed.
- **Swing Bearing** - Grease swing bearing. Service every 10 hours when operating in water.
- **Blade, Boom Swing, Boom Swing Cylinder and Bucket Pivot Points** - Add Grease. Service every 10 hours when operating in water.
- **Battery** - Check cables, connections, and electrolyte level; add distilled water as needed.
- **Fuel Tank** - Drain water and sediment from fuel tank.

Every 100 Hours

- **Drive Belts (Alternator, air conditioning, water pump)** - Check condition. Replace as needed. Service at first 50 hours, then as scheduled.

Every 250 Hours Or Every 12 Months

- **Boom and Arm (Workgroup) Pivot Points** - Add Grease. Service every 10 hours when operating in water.
- **Engine Oil and Filter** - Service at first 50 hours, then as scheduled. Replace oil and filter.
- **Fuel / Water Separator Screen** - Service at first 50 hours, then as scheduled. Replace as needed.
- **Travel Motors (Final Drive)** - Check fluid level and add as needed.

Dealer Copy -- Not for Resale

<https://www.ebooklibonline.com>

Hello dear friend!

Thank you very much for reading.

Enter the link into your browser.

The full manual is available for immediate download.

<https://www.ebooklibonline.com>