



# Bobcat®

---

## Service Manual E55 Compact Excavator

---

S/N ARWM11001 & Above  
S/N ASW311001 & Above

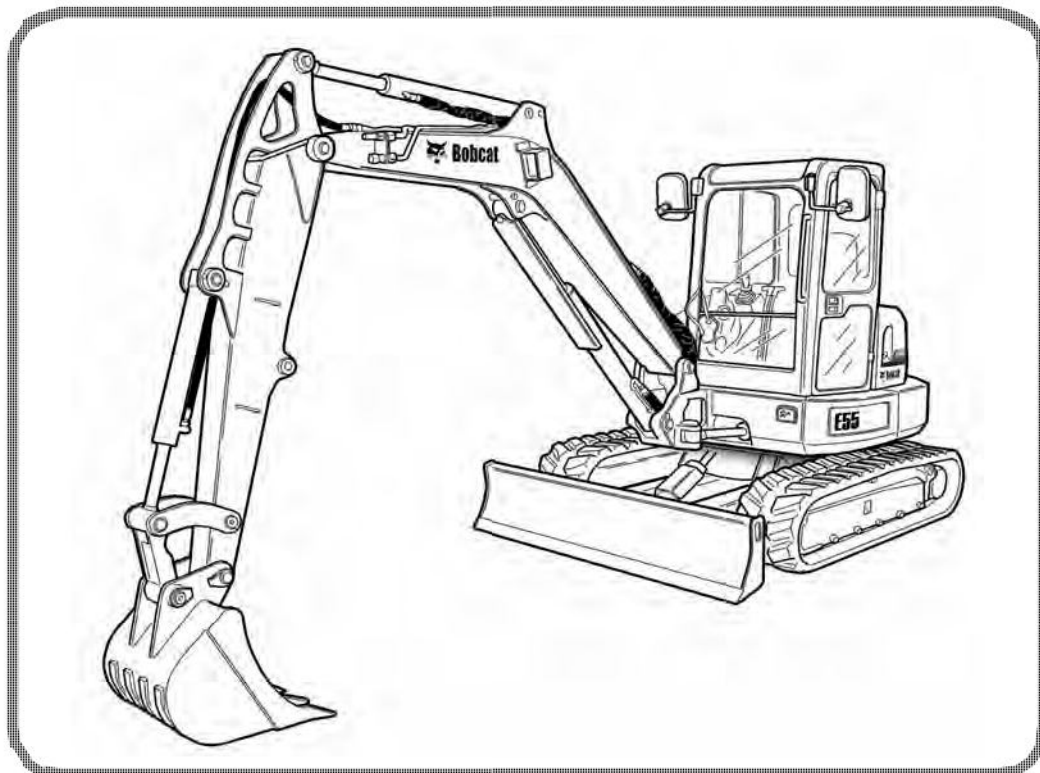

Dealer Copy -- Not for Resale



# MAINTENANCE SAFETY



## WARNING

Instructions are necessary before operating or servicing machine. Read and understand the Operation & Maintenance Manual, Operator's Handbook and signs (decals) on machine. Follow warnings and instructions in the manuals when making repairs, adjustments or servicing. Check for correct function after adjustments, repairs or service. Untrained operators and failure to follow instructions can cause injury or death.

W-2003-0807



**Safety Alert Symbol:** This symbol with a warning statement, means: "Warning, be alert! Your safety is involved!" Carefully read the message that follows.

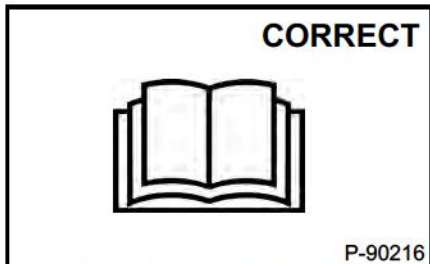

P-90216

⚠ Never service the Bobcat Excavator without instructions.

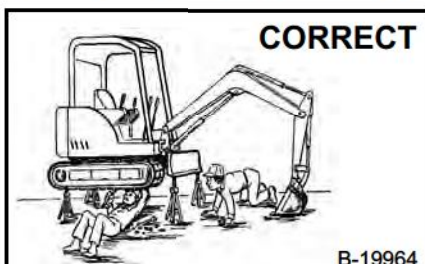

B-19964

⚠ Use the correct procedure to lift and support the excavator.

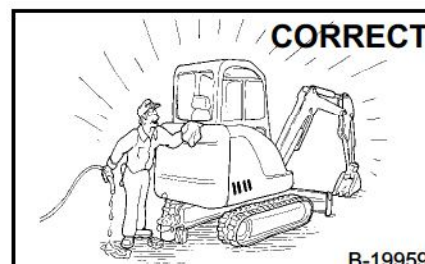

B-19959

⚠ Cleaning and maintenance are required daily.

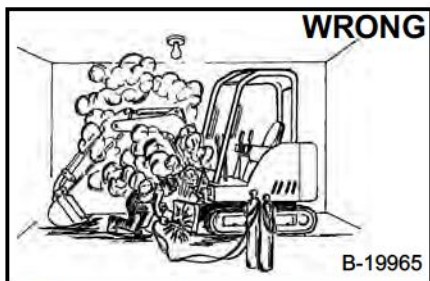

B-19965

⚠ Have good ventilation when welding or grinding painted parts.  
⚠ Wear dust mask when grinding painted parts. Toxic dust and gas can be produced.

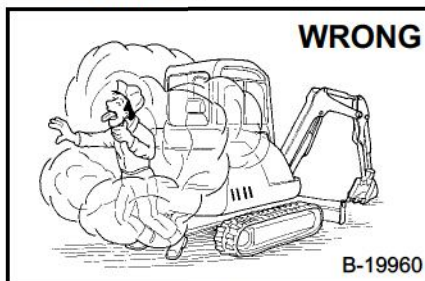

B-19960

⚠ Vent exhaust to outside when engine must be run for service.  
⚠ Exhaust system must be tightly sealed. Exhaust fumes can kill without warning.

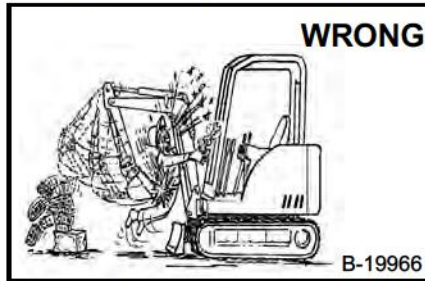

B-19966

⚠ Always lower the bucket and blade to the ground before doing any maintenance.  
⚠ Never modify equipment or add attachments not approved by Bobcat Company.

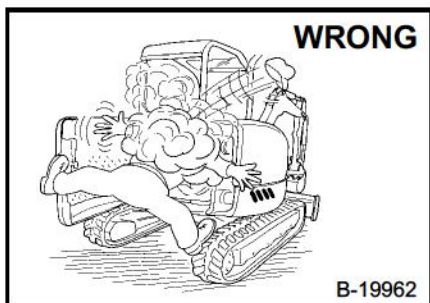

B-19962

⚠ Stop, cool and clean engine of flammable materials before checking fluids.  
⚠ Never service or adjust machine with the engine running unless instructed to do so in the manual.  
⚠ Avoid contact with leaking hydraulic fluid or diesel fuel under pressure. It can penetrate the skin or eyes.  
⚠ Never fill fuel tank with engine running, while smoking, or when near open flame.

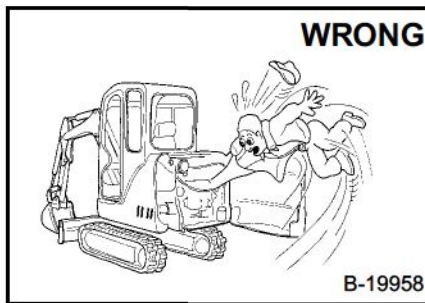

B-19958

⚠ Keep body, jewelry and clothing away from moving parts, electrical contact, hot parts and exhaust.  
⚠ Wear eye protection to guard from battery acid, compressed springs, fluids under pressure and flying debris when engines are running or tools are used. Use eye protections approved for type of welding.  
⚠ Keep tailgate closed except for service. Close and latch tailgate before operating the excavator.

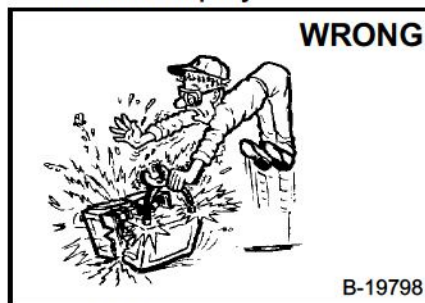

B-19798

⚠ Lead-acid batteries produce flammable and explosive gases.  
⚠ Keep arcs, sparks, flames and lighted tobacco away from batteries.  
⚠ Batteries contain acid which burns eyes or skin on contact.  
⚠ Wear protective clothing. If acid contacts body, flush well with water. For eye contact flush well and get immediate medical attention.

Maintenance procedures which are given in the Operation & Maintenance Manual can be performed by the owner/operator without any specific technical training. Maintenance procedures which are not in the Operation & Maintenance Manual must be performed **ONLY BY QUALIFIED BOBCAT SERVICE PERSONNEL**. Always use genuine Bobcat replacement parts. The Service Safety Training Course is available from your Bobcat dealer.

MSW28-0409

Dealer Copy -- Not for Resale

## CONTENTS

SAFETY AND MAINTENANCE .....	10-01
HYDRAULIC SYSTEM .....	20-01
UNDERCARRIAGE .....	30-01
UPPERSTRUCTURE AND SWING SECTION .....	40-01
ELECTRICAL SYSTEM AND ANALYSIS .....	50-01
ENGINE SERVICE .....	60-01
HEATING, VENTILATION AND AIR CONDITIONING S/N ARWM11001 - ARWM11999 AND ASW311001- ASW311999 .....	70-01
HEATING, VENTILATION AND AIR CONDITIONING S/N ARWM12000 & ABOVE AND ASW312000 & ABOVE .....	71-01
SPECIFICATIONS .....	SPEC-01
ALPHABETICAL INDEX .....	INDEX-01

Dealer Copy -- Not for Resale

## FOREWORD

FOREWORD .....	1-7
SAFETY INSTRUCTIONS .....	1-9
FIRE PREVENTION .....	1-11
Maintenance .....	1-11
Operation .....	1-11
Electrical .....	1-11
Hydraulic System .....	1-11
Fueling .....	1-11
Starting .....	1-11
Spark Arrester Exhaust System .....	1-11
Welding And Grinding .....	1-12
Fire Extinguishers .....	1-12
SERIAL NUMBER LOCATIONS .....	1-13
Excavator Serial Number .....	1-13
Engine Serial Number .....	1-13
DELIVERY REPORT .....	1-14
EXCAVATOR IDENTIFICATION .....	1-15

Dealer Copy -- Not for Resale

**<https://www.ebooklibonline.com>**

Hello dear friend!

Thank you very much for reading.

Enter the link into your browser.

The full manual is available for immediate download.

**<https://www.ebooklibonline.com>**

# FOREWORD

This manual is for the Bobcat excavator mechanic. It provides necessary servicing and adjustment procedures for the Bobcat excavator and its component parts and systems. Refer to the Operation & Maintenance Manual for operating instructions, starting procedure, daily checks, etc.

A general inspection of the following items must be made after the excavator has had service or repair:

1. Check that the ROPS/TOPS/FOPS is in good condition and is not modified.



2. Check that ROPS/TOPS mounting hardware is tightened and is Bobcat approved.



3. The seat belt must be correctly installed, functional and in good condition.



4. Machine signs (decals) must be legible and in the correct location.



5. Travel levers, control levers and foot pedals must return to neutral. Check that the pedal locks are in working order.

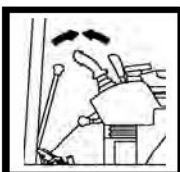

6. Check for correct function of the work lights.



7. Enclosure door latches must open and close freely.

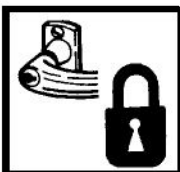

8. Attachment locking pins must function correctly and be in good condition.

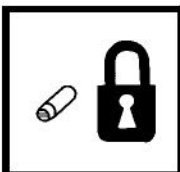

9. Safety treads must be in good condition.

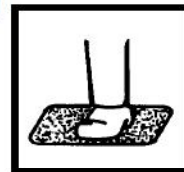

10. Check for correct function of indicator lamps.

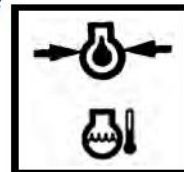

11. Check hydraulic fluid level, engine oil level and fuel supply.



12. Inspect for fuel, oil or hydraulic fluid leaks.



13. Lubricate the excavator.



14. Check the condition of the battery and cables.

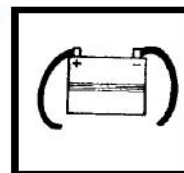

15. Inspect the air cleaner for damage or leaks. Check the condition of the element.

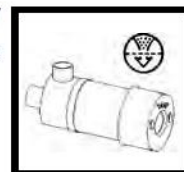

16. Check the electrical charging system.

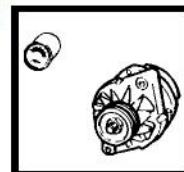

Dealer Copy -- Not for Resale

FW EXC-0509 SM

17. Check tracks for wear and tension. Use only approved tracks.

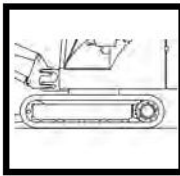

21. Check the control console interlocks for correct function.



18. Inspect for loose or broken parts or connections.



22. Inspect the X-Change™ for wear or damage. Repair or replace damaged parts.

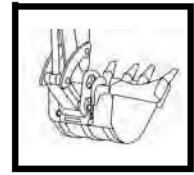

19. Check for any field modification not completed.



23. Check function or condition of all equipped options and accessories (examples: special applications kit, motion alarm, etc.).



20. Operate the machine and check all functions.



24. Recommend to the owner that all necessary corrections be made before the machine is returned to service.



**CALIFORNIA  
PROPOSITION 65 WARNING**  
Diesel engine exhaust and some of its constituents are known to the state of California to cause cancer, birth defects and other reproductive harm.

## SAFETY INSTRUCTIONS



### Safety Alert Symbol

This symbol with a warning statement means:  
"Warning, be alert! Your safety is involved!"  
Carefully read the message that follows.



## WARNING

### AVOID INJURY OR DEATH

Instructions are necessary before operating or servicing machine. Read and understand the Operation & Maintenance Manual, Operator's Handbook and signs (decals) on machine. Follow warnings and instructions in the manuals when making repairs, adjustments or servicing. Check for correct function after adjustments, repairs or service. Untrained operators and failure to follow instructions can cause injury or death.

W-2003-0807

## IMPORTANT

This notice identifies procedures which must be followed to avoid damage to the machine.

I-2019-0284



## DANGER

The signal word DANGER on the machine and in the manuals indicates a hazardous situation which, if not avoided, will result in death or serious injury.

D-1002-1107



## WARNING

The signal word WARNING on the machine and in the manuals indicates a potentially hazardous situation which, if not avoided, could result in death or serious injury.

W-2044-1107

The following publications provide information on the safe use and maintenance of the Bobcat machine and attachments:

- The Delivery Report is used to assure that complete instructions have been given to the new owner and that the machine is in safe operating condition.
- The Operation & Maintenance Manual delivered with the machine or attachment contains operating information as well as routine maintenance and service procedures. It is a part of the machine and can be stored in a container provided on the machine. Replacement Operation & Maintenance Manuals can be ordered from your Bobcat dealer.
- Machine signs (decals) instruct on the safe operation and care of your Bobcat machine or attachment. The signs and their locations are shown in the Operation & Maintenance Manual. Replacement signs are available from your Bobcat dealer.
- An Operator's Handbook fastened to the operator cab. It's brief instructions are convenient to the operator. The handbook is available from your dealer in an English edition or one of many other languages. See your Bobcat dealer for more information on translated versions.
- The AEM Safety Manual delivered with the machine gives general safety information.
- The Service Manual and Parts Manual are available from your dealer for use by mechanics to do shop-type service and repair work.
- The Compact Excavator Operator Training Course is available through your local dealer or at [www.training.bobcat.com](http://www.training.bobcat.com) or [www.bobcat.com](http://www.bobcat.com). This course is intended to provide rules and practices of correct operation of the Bobcat excavator. The course is available in English and Spanish versions.
- Service Safety Training Courses are available from your Bobcat dealer or at [www.training.bobcat.com](http://www.training.bobcat.com) or [www.bobcat.com](http://www.bobcat.com). They provide information for safe and correct service procedures.
- The Bobcat compact excavator Safety Video is available from your Bobcat dealer or at [www.training.bobcat.com](http://www.training.bobcat.com) or [www.bobcat.com](http://www.bobcat.com).

Dealer Copy -- Not for Resale

SI EXC-0913 SM

## FIRE PREVENTION



### Maintenance

The machine and some attachments have components that are at high temperatures under normal operating conditions. The primary source of high temperatures is the engine and exhaust system. The electrical system, if damaged or incorrectly maintained, can be a source of arcs or sparks.

Flammable debris (leaves, straw, etc.) must be removed regularly. If flammable debris is allowed to accumulate, it can cause a fire hazard. Clean often to avoid this accumulation. Flammable debris in the engine compartment is a potential fire hazard.

The operator's area, engine compartment and engine cooling system must be inspected every day and cleaned if necessary to prevent fire hazards and overheating.

All fuels, most lubricants and some coolants mixtures are flammable. Flammable fluids that are leaking or spilled onto hot surfaces or onto electrical components can cause a fire.

### Operation

Do not use the machine where exhaust, arcs, sparks or hot components can contact flammable material, explosive dust or gases.

### Electrical



Check all electrical wiring and connections for damage. Keep the battery terminals clean and tight. Repair or replace any damaged part or wires that are loose or frayed.

Battery gas can explode and cause serious injury. Use the procedure in the Operation & Maintenance Manual for connecting the battery and for jump starting. Do not jump start or charge a frozen or damaged battery. Keep any open flames or sparks away from batteries. Do not smoke in battery charging area.

## Hydraulic System

Check hydraulic tubes, hoses and fittings for damage and leakage. Never use open flame or bare skin to check for leaks. Hydraulic tubes and hoses must be properly routed and have adequate support and secure clamps. Tighten or replace any parts that show leakage.

Always clean fluid spills. Do not use gasoline or diesel fuel for cleaning parts. Use commercial nonflammable solvents.

### Fueling



Stop the engine and let it cool before adding fuel. No smoking! Do not refuel a machine near open flames or sparks. Fill the fuel tank outdoors.

Ultra Low Sulfur Diesel (ULSD) poses a greater static ignition hazard than earlier diesel formulations with higher Sulfur content. Avoid death or serious injury from fire or explosion. Consult with your fuel or fuel system supplier to ensure the delivery system is in compliance with fueling standards for proper grounding and bonding practices.

### Starting

Do not use ether or starting fluids on any engine that has glow plugs. These starting aids can cause explosion and injure you or bystanders.

Use the procedure in the Operation & Maintenance Manual for connecting the battery and for jump starting.

### Spark Arrester Exhaust System

The spark arrester exhaust system is designed to control the emission of hot particles from the engine and exhaust system, but the muffler and the exhaust gases are still hot.

Check the spark arrester exhaust system regularly to make sure it is maintained and working properly. Use the procedure in the Operation & Maintenance Manual for cleaning the spark arrester muffler (if equipped).

Dealer Copy -- Not for Resale

SI EXC-0913 SM

## FIRE PREVENTION (CONT'D)

### Welding And Grinding

Always clean the machine and attachment, disconnect the battery, and disconnect the wiring from the Bobcat controllers before welding. Cover rubber hoses, battery and all other flammable parts. Keep a fire extinguisher near the machine when welding.

Have good ventilation when grinding or welding painted parts. Wear dust mask when grinding painted parts. Toxic dust or gas can be produced.

Dust generated from repairing nonmetallic parts such as hoods, fenders or covers can be flammable or explosive. Repair such components in a well ventilated area away from open flames or sparks.

### Fire Extinguishers



Know where fire extinguishers and first aid kits are located and how to use them. Inspect the fire extinguisher and service the fire extinguisher regularly. Obey the recommendations on the instructions plate.

## SERIAL NUMBER LOCATIONS

Always use the serial number of the excavator when requesting service information or when ordering parts. Early or later models (identification made by serial number) may use different parts, or it may be necessary to use a different procedure in doing a specific service operation.

### Excavator Serial Number

Figure 1

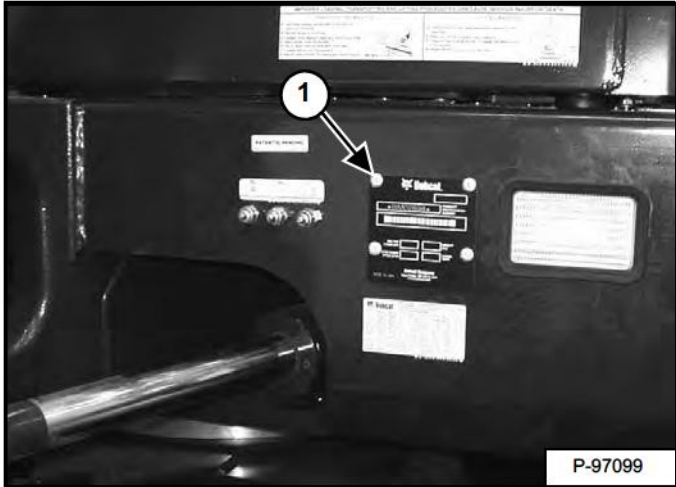

The excavator serial number plate (Item 1) is located on the frame of the machine in the location shown [Figure 1].

Figure 2

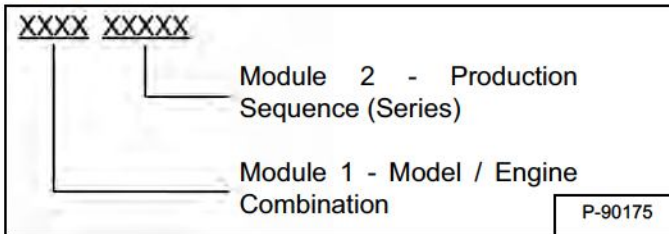

Explanation of excavator Serial Number [Figure 2]:

1. The four digit Model / Engine Combination Module number identifies the model number and engine combination.
2. The five digit Production Sequence Number identifies the order which the excavator is produced.

### Engine Serial Number

Figure 3

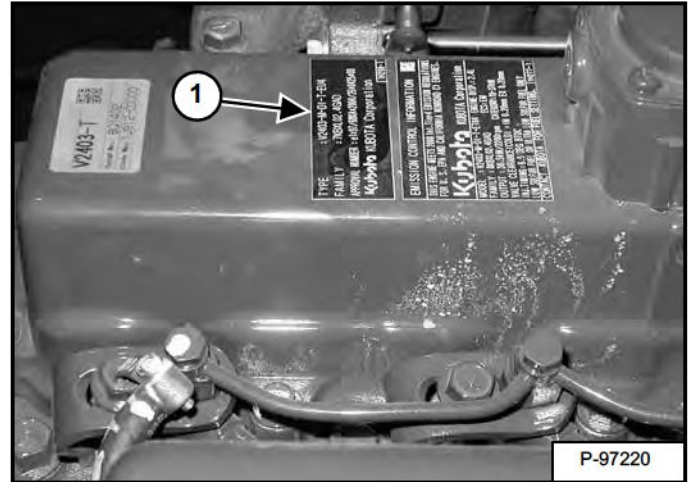

The engine serial number (Item 1) [Figure 3] is located on the top cover.

## DELIVERY REPORT

Figure 4

The diagram shows a form titled "DELIVERY REPORT". The form is divided into several sections. At the top right, the title "DELIVERY REPORT" is printed. Below the title, there are several horizontal lines for text entry. On the left side, there is a section with a dark header containing the word "WARNING" in white capital letters. Below this header are several horizontal lines. The bottom right corner of the form contains the alphanumeric code "B-16315".

The delivery report [Figure 4] must be completed by the dealer and signed by the owner or operator when the Bobcat excavator is delivered. An explanation of the form must be given to the owner. Make sure it is filled out completely.

**EXCAVATOR IDENTIFICATION**

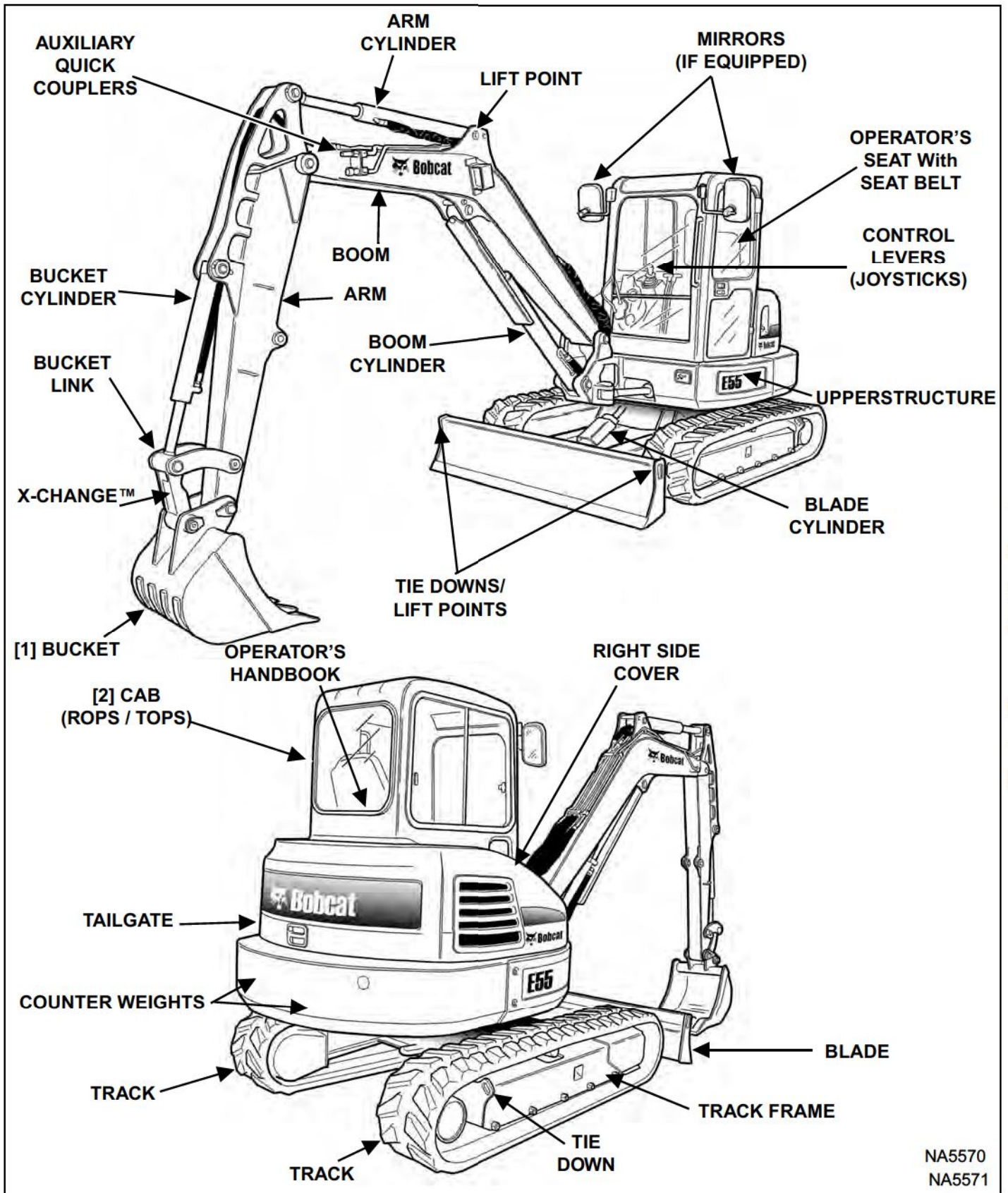

- [1] BUCKET - Several different buckets and other attachments are available for the Bobcat Excavator.
- [2] ROPS / TOPS - (Roll-Over Protective Structure / Tip-Over Protective Structure) as standard equipment. The ROPS / TOPS meets ISO 12117-2 and ISO 12117.

Dealer Copy -- Not for Resale

NA5570  
NA5571

## SAFETY AND MAINTENANCE

LIFTING AND BLOCKING THE EXCAVATOR .....	10-10-1
Procedure .....	10-10-1
LIFTING THE EXCAVATOR .....	10-20-1
Procedure .....	10-20-1
OPERATOR CAB (ROPS / TOPS) .....	10-30-1
Description .....	10-30-1
Cab Door .....	10-30-1
Front Window .....	10-30-2
Front Wiper .....	10-30-3
Window Washer Reservoir .....	10-30-4
Right Side Windows .....	10-30-4
TRANSPORTING THE EXCAVATOR ON A TRAILER .....	10-40-1
Loading And Unloading .....	10-40-1
Fastening .....	10-40-1
TAILGATE .....	10-50-1
Opening And Closing .....	10-50-1
Adjusting The Latch .....	10-50-1
RIGHT SIDE COVER .....	10-60-1
Opening And Closing .....	10-60-1
SERVICE SCHEDULE .....	10-70-1
Maintenance Intervals .....	10-70-1
AIR CLEANER SERVICE .....	10-80-1
Daily Check .....	10-80-1
Replacing The Filters Elements .....	10-80-1
CAB FILTERS (S/N ARWM11001 - ARWM11999 AND ASW311001- ASW311999)	
.....	10-90-1
Cleaning And Maintenance .....	10-90-1
CAB FILTERS (S/N ARWM12000 & ABOVE AND ASW312000 & ABOVE)	
Cleaning And Maintenance .....	10-91-1
ENGINE COOLING SYSTEM .....	10-100-1
Cleaning .....	10-100-1
Checking Level .....	10-100-2
Removing And Replacing Coolant .....	10-100-3

Dealer Copy -- Not for Resale

FUEL SYSTEM .....	10-110-1
Fuel Specifications .....	10-110-1
Biodiesel Blend Fuel .....	10-110-1
Filling The Fuel Tank .....	10-110-2
Fuel Filters .....	10-110-3
Draining The Fuel Tank .....	10-110-3
Removing Air From The Fuel System .....	10-110-4
ENGINE LUBRICATION SYSTEM .....	10-120-1
Checking And Adding Engine Oil .....	10-120-1
Engine Oil Chart .....	10-120-1
Removing And Replacing Oil And Filter .....	10-120-2
HYDRAULIC SYSTEM .....	10-130-1
Checking And Adding Hydraulic Fluid .....	10-130-1
Hydraulic / Hydrostatic Fluid Chart .....	10-130-2
Removing And Replacing The Hydraulic Filters .....	10-130-2
Removing And Replacing The Hydraulic Fluid .....	10-130-4
LUBRICATING THE EXCAVATOR .....	10-140-1
Lubrication Locations .....	10-140-1
PIVOT PINS .....	10-150-1
Inspection And Maintenance .....	10-150-1
TRAVEL MOTOR .....	10-160-1
Checking And Adding Oil .....	10-160-1
Removing And Replacing Oil .....	10-160-1
SPARK ARRESTER MUFFLER .....	10-170-1
Cleaning Procedure .....	10-170-1
EMERGENCY EXIT .....	10-180-1
Right Side Rear Window .....	10-180-1
Front Window .....	10-180-1
SEAT BELT .....	10-190-1
Inspection And Maintenance .....	10-190-1
CONTROL CONSOLE LOCKOUTS .....	10-200-1
Inspection And Maintenance .....	10-200-1
TOWING THE EXCAVATOR .....	10-210-1
Procedure .....	10-210-1
REMOTE START TOOL KIT - MEL1563 .....	10-220-1
Remote Start Tool - MEL1563 .....	10-220-1
Service Tool Harness Control - MEL1565 .....	10-220-2
Service Tool Harness Communicator - MEL1566 .....	10-220-3

REMOTE START TOOL (SERVICE TOOL) KIT - 7217666 .....	10-221-1
Description .....	10-221-1
Remote Start Tool (Service Tool) - 7022042 .....	10-221-2
Excavator Service Tool Harness - 6689747 .....	10-221-3
Computer Service Tool Harness - 6689746 .....	10-221-4

Dealer Copy -- Not for Resale

## LIFTING AND BLOCKING THE EXCAVATOR

### Procedure

Always park the machine on a level surface.



#### AVOID INJURY OR DEATH

Instructions are necessary before operating or servicing machine. Read and understand the Operation & Maintenance Manual, Operator's Handbook and signs (decals) on machine. Follow warnings and instructions in the manuals when making repairs, adjustments or servicing. Check for correct function after adjustments, repairs or service. Untrained operators and failure to follow instructions can cause injury or death.

W-2003-0807



Put jackstands under the front axles and rear corners of the frame before running the engine for service. Failure to use jackstands can allow the machine to fall or move and cause injury or death.

W-2017-0286

Figure 10-10-1

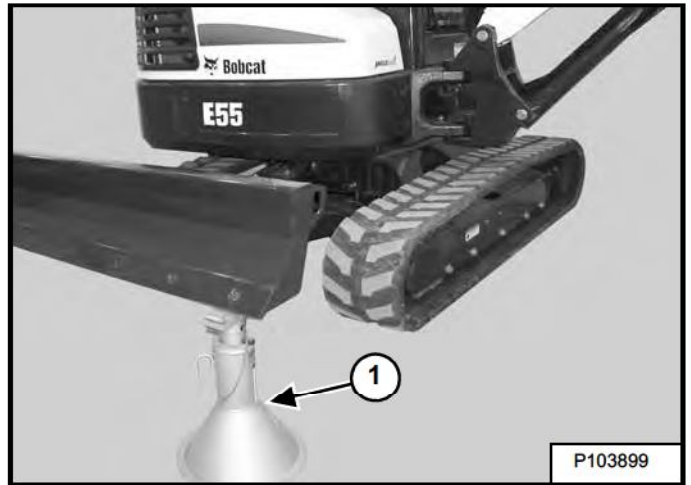
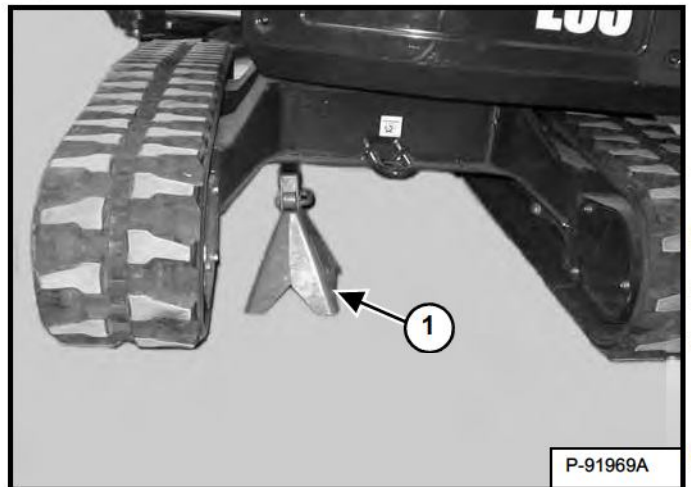

Figure 10-10-1



Raise one side of the machine (approximately 101,6 mm [4 in]) using the boom and arm [Figure 10-10-1] and [Figure 10-10-1].

Raise the blade fully and install jackstands under the blade and track frame (Item 1) [Figure 10-10-1] and [Figure 10-10-1]. Raise the boom until all machine weight is on the jackstands.

Repeat the procedure for the other side.

Stop the engine.

Dealer Copy -- Not for Resale

## LIFTING THE EXCAVATOR

### Procedure

Figure 10-20-1

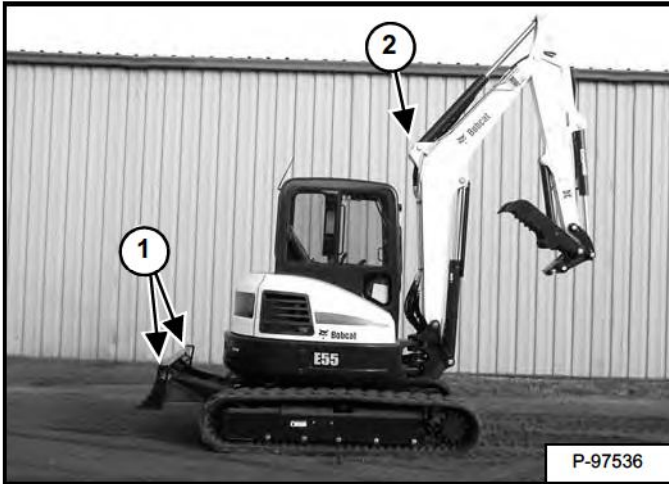

Fully extend the cylinders of the bucket, arm, and boom so that the excavator is in the position as shown [Figure 10-20-1].

Raise the blade all the way.

Put all the control levers in neutral.

**NOTE:** For machines equipped with the angle blade feature, make sure the blade is in the straight position prior to lifting.

## **WARNING**

### AVOID INJURY OR DEATH

- Use chains and lifting equipment with sufficient capacity for the weight of the excavator plus any added attachments.
- Maintain center of gravity and balance when lifting.
- Do not swing boom or upperstructure. Engage the upperstructure slew lock.
- Never lift with operator on machine.
- Never lift with the blade angled (if equipped).

W-2580-0607

Figure 10-20-2

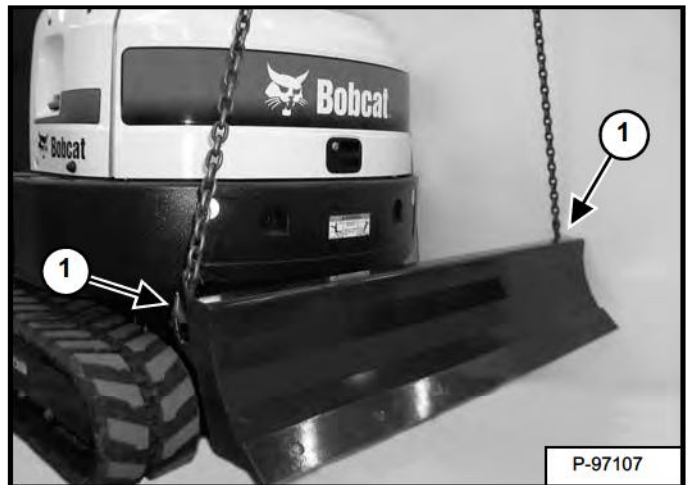
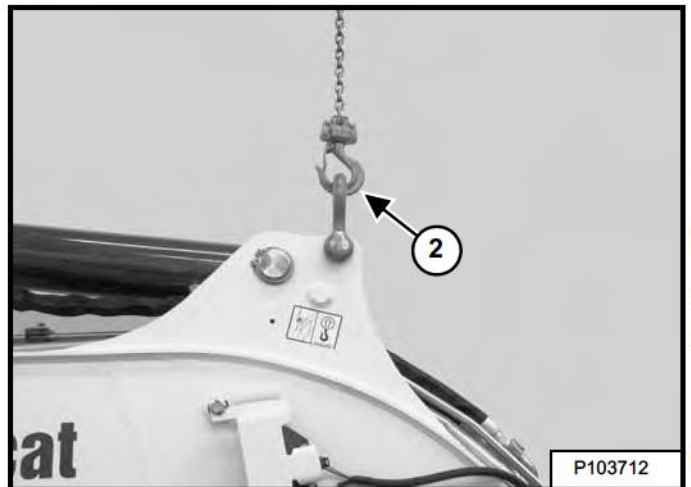

Figure 10-20-3



Fasten chains to the ends of the blade (Item 1) [Figure 10-20-2] and [Figure 10-20-3] and up to a lifting fixture above the cab. The lifting fixture must extend over the sides of the cab to prevent the chains from hitting the ROPS / TOPS.

Fasten a clevis and chain (Item 2) [Figure 10-20-1] and [Figure 10-20-3] from the boom to the lift fixture.

Dealer Copy -- Not for Resale

## OPERATOR CAB (ROPS / TOPS)

### Description

The Bobcat excavator has an operator cab (ROPS / TOPS) as standard equipment to protect the operator if the excavator is tipped over. The seat belt must be worn for ROPS / TOPS protection.

Check the ROPS / TOPS cab, mounting, and hardware for damage. Never modify the ROPS / TOPS cab. Replace the cab and hardware if damaged. See your Bobcat dealer for parts.

ROPS / TOPS - Roll-Over Protective Structure per ISO 12117-2, and Tip-Over Protective Structure per ISO 12117.



**Never modify operator cab by welding, grinding, drilling holes or adding attachments unless instructed to do so by Bobcat Company. Changes to the cab can cause loss of operator protection from rollover and falling objects, and result in injury or death.**

W-2069-0200

## OPERATOR CAB (ROPS / TOPS) (CONT'D)

### Cab Door

Figure 10-30-1

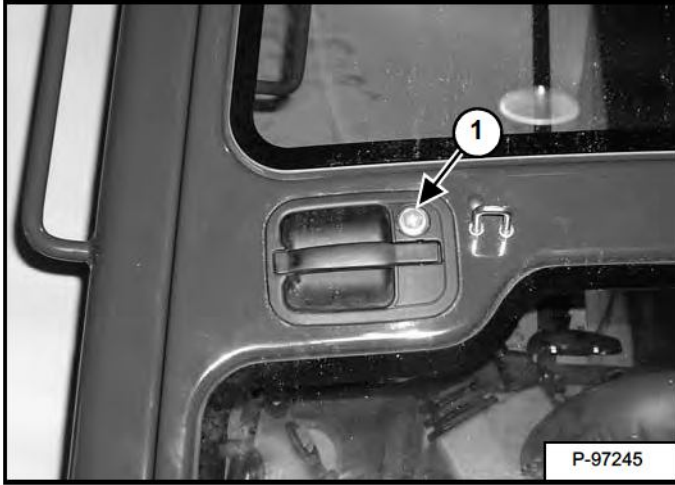

The cab door can be locked (Item 1) [Figure 10-30-1] with the same key as the starter switch.

Figure 10-30-2

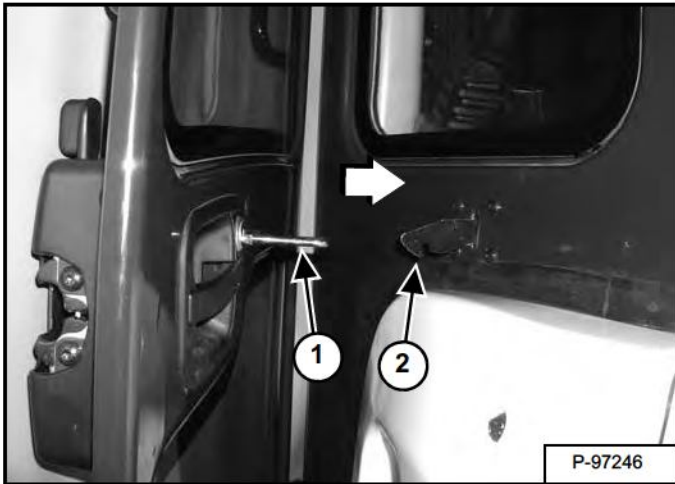

Push the door all the way open until the latch post (Item 1) engages in the latch (Item 2) [Figure 10-30-2] to hold the door in the open position.

Figure 10-30-3

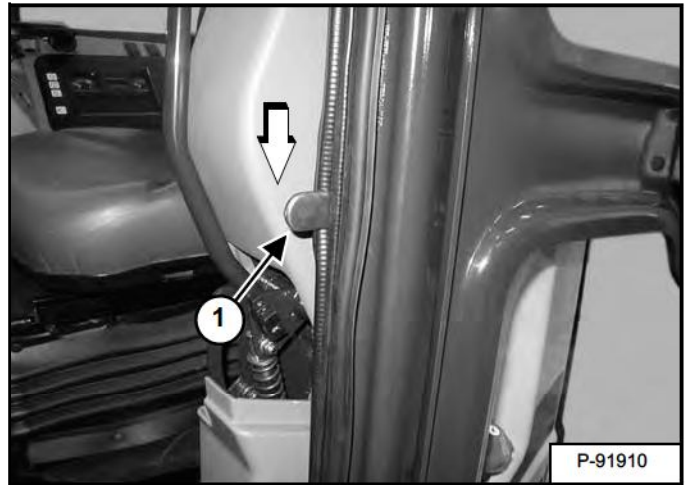

When the door is in the open position, push down on the latch (Item 1) [Figure 10-30-3] and close the door.

Figure 10-30-4

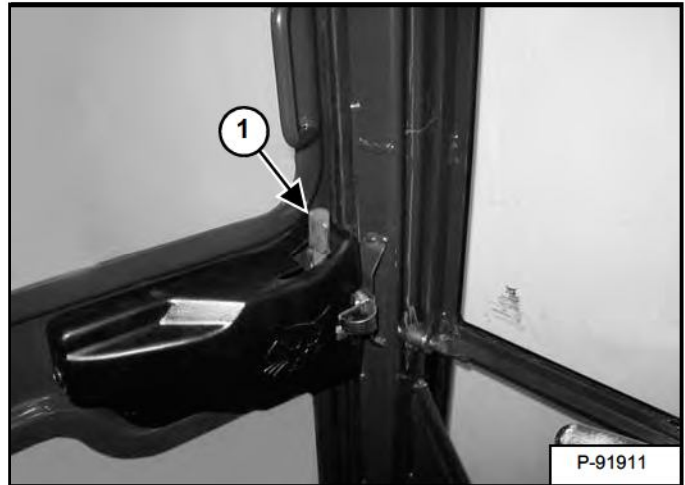

From inside the cab, open the door using handle (Item 1) [Figure 10-30-4].

## OPERATOR CAB (ROPS / TOPS) (CONT'D)

### Front Window

#### Opening The Front Window

Figure 10-30-5

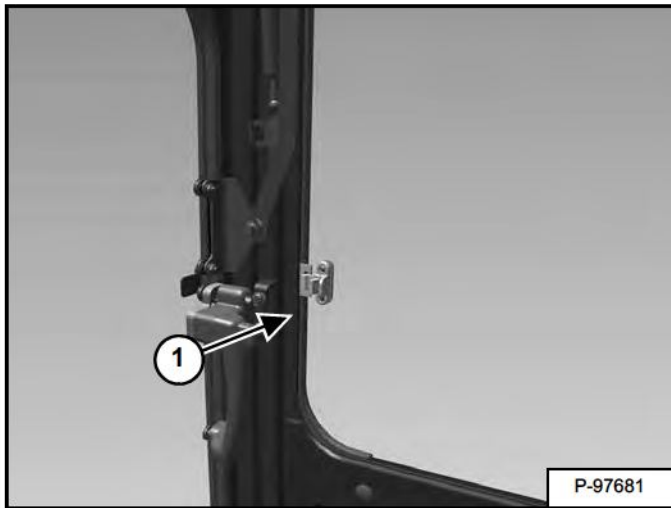

Press the window latch button (Item 1) [Figure 10-30-5] (both sides).

Figure 10-30-6



Use both window grab handles (Item 1) [Figure 10-30-6] to pull the top of the window in.

Continue moving the window in and up over the operator's head until the window is fully raised.

Figure 10-30-7

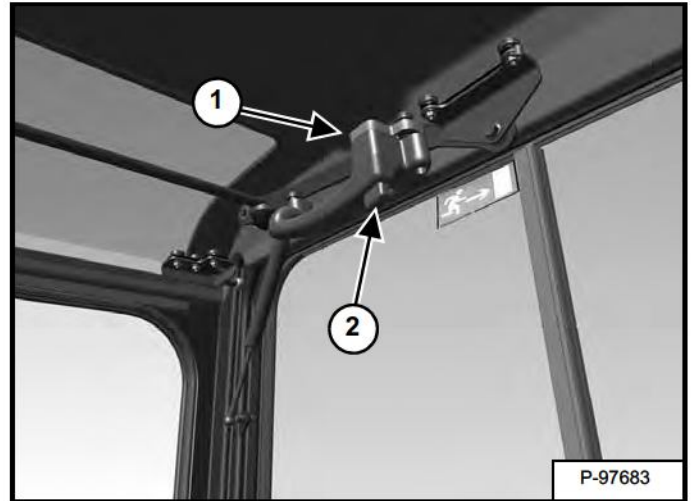

When the window is fully raised, the latch (Item 1) [Figure 10-30-7] (both sides) will close on the bracket in the latched position.

Pull down and forward slightly on the window to make sure it is fully latched.

#### Closing The Front Window

Use both window grab handles to support the window while pressing the window latch button (Item 2) [Figure 10-30-7] (both sides).

Use both window grab handles (Item 1) [Figure 10-30-6] to pull the window down fully.

Press the top of the window in until the latch locks into the latched position (both sides) [Figure 10-30-5].

Pull inward and upward slightly on the window to make sure it is fully latched in the closed position.

Dealer Copy -- Not for Resale

## OPERATOR CAB (ROPS / TOPS) (CONT'D)

### Front Wiper

Figure 10-30-8



The front window is equipped with a wiper (Item 1) [Figure 10-30-8] and washer.

### Window Washer Reservoir

Figure 10-30-9

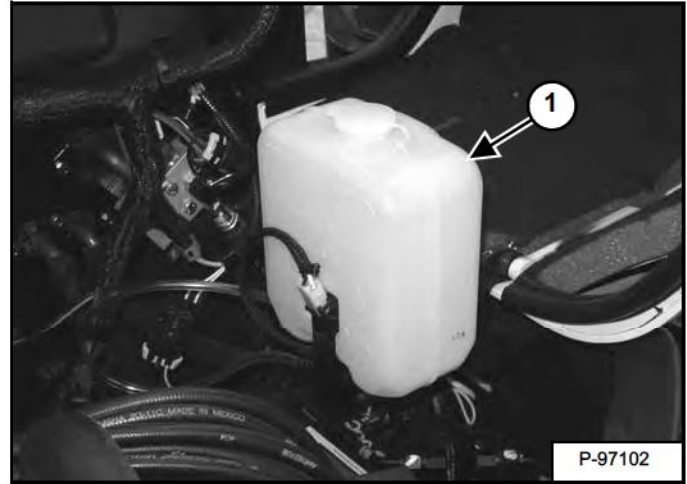

The window washer reservoir (Item 1) [Figure 10-30-9] is located under the right side cover.

## OPERATOR CAB (ROPS / TOPS) (CONT'D)

### Right Side Windows

#### *Opening The Right Rear Window*

**Figure 10-30-10**

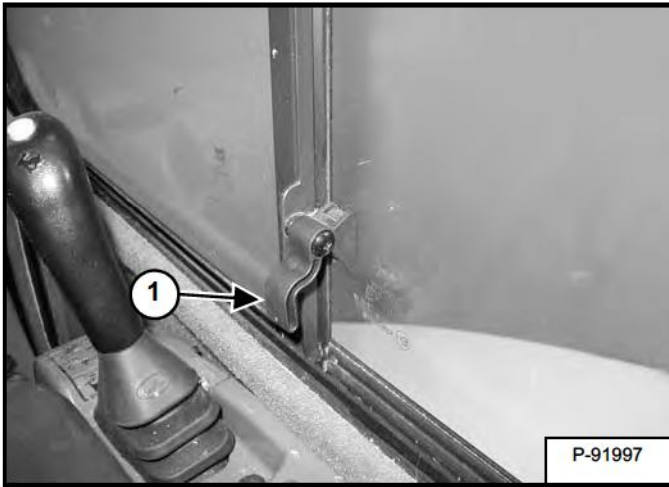

Raise the latch (Item 1) [Figure 10-30-10] located at the rear of the front window.

**Figure 10-30-11**

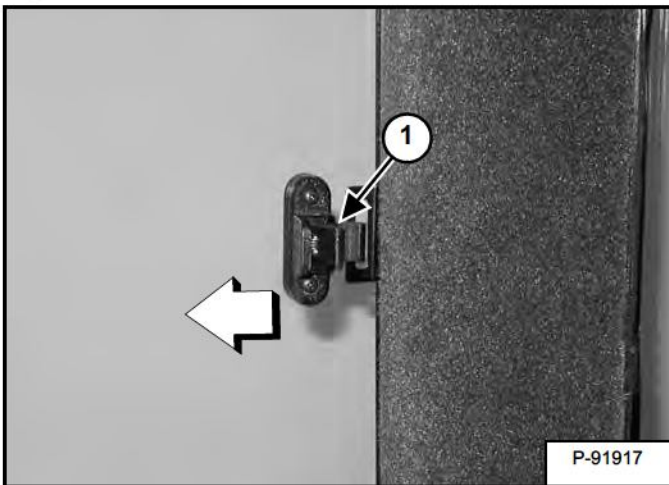

Pull out on the latch (Item 1) [Figure 10-30-11].

**Figure 10-30-12**

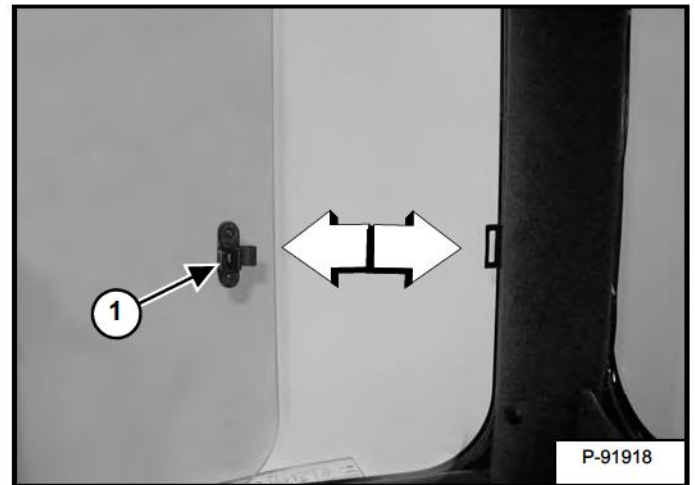

Pull the latch (Item 1) [Figure 10-30-12] forward to open the window. When the window is in the open position, push down on the latch (Item 1) [Figure 10-30-10].

#### *Closing The Right Rear Window*

Raise the latch (Item 1) [Figure 10-30-13].

Push the latch (Item 1) [Figure 10-30-12] back to close the window. Rotate the latch (Item 1) [Figure 10-30-10] down.

Dealer Copy -- Not for Resale

## OPERATOR CAB (ROPS / TOPS) (CONT'D)

### Right Side Windows (Cont'd)

#### Opening The Right Front Window

Figure 10-30-13

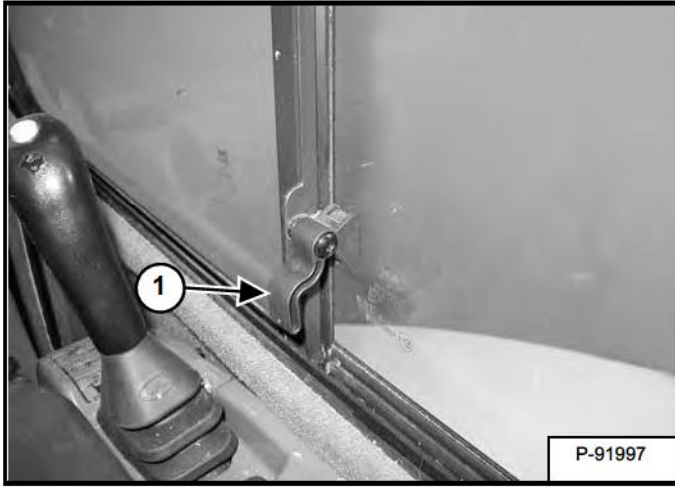

Raise the latch (Item 1) [Figure 10-30-13] located at the rear of the front window.

Figure 10-30-14

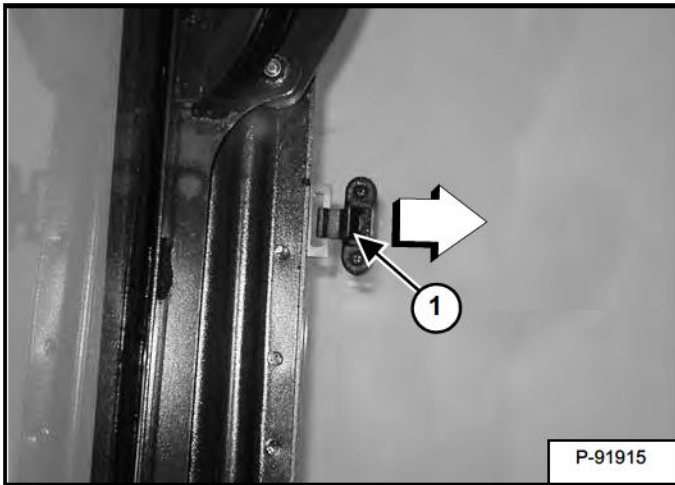

Pull back on the latch (Item 1) [Figure 10-30-14].

Figure 10-30-15

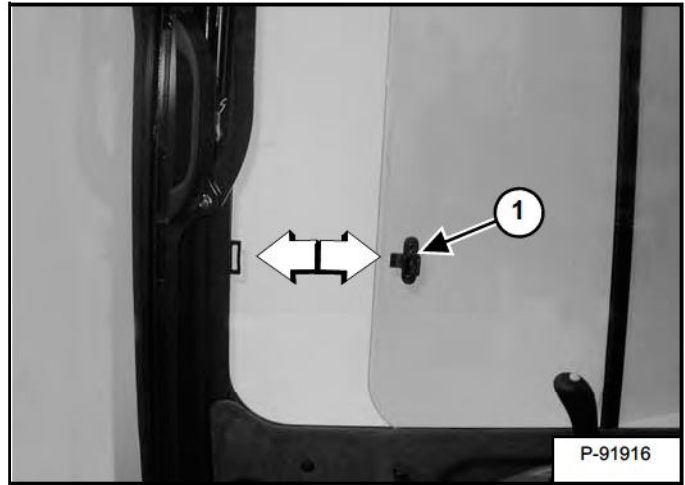

Pull the latch (Item 1) [Figure 10-30-15] back to open the window.

When the window is in the open position, push down on the latch (Item 1) [Figure 10-30-13].

#### Closing The Right Front Window

Raise the latch (Item 1) [Figure 10-30-13].

Push the handle (Item 1) [Figure 10-30-15] forward to close the window. Rotate the latch (Item 1) [Figure 10-30-13] down.

## TRANSPORTING THE EXCAVATOR ON A TRAILER

### Loading And Unloading

When transporting the machine, observe the rules, motor vehicle laws, and vehicle limit ordinances. Use a transport and towing vehicle of adequate length and capacity.

Secure the parking brakes and block the wheels of the transport vehicle.

Align the ramps with the center of the transport vehicle. Secure the ramps to the truck bed and be sure ramp angle does not exceed 15 degrees.

Use metal loading ramps with a slip resistant surface.

Use ramps that are the correct length and width and can support the weight of the machine.

The rear of the trailer must be blocked or supported when loading or unloading the machine to prevent the front of the transport vehicle from raising.

Determine the direction of the track movement before moving the machine (blade forward).

Disengage the auto idle feature and move the two speed travel to the low range position.

For machines equipped with the extendable arm feature, retract the arm and lock the arm in the retracted position.

Figure 10-40-1



Move the machine forward onto the transport vehicle [Figure 10-40-1].

Do not change direction of the machine while it is on the ramps.

Lower the boom, arm, bucket, and blade to the transport vehicle.

Stop the engine and remove the key (if equipped).

Put blocks at the front and rear of the tracks.

### Fastening

Figure 10-40-2

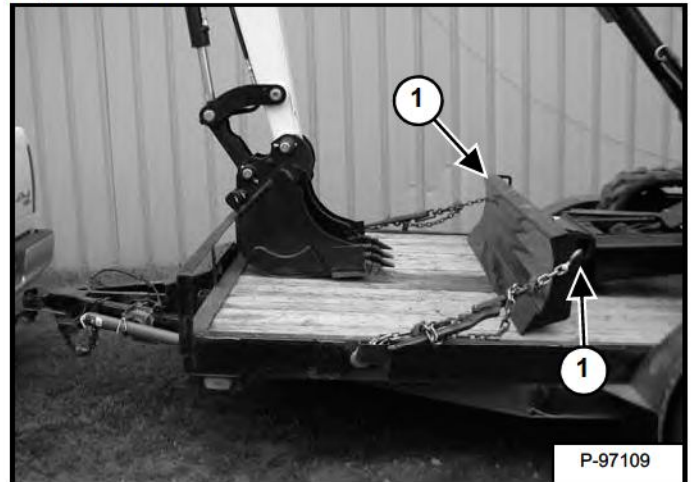
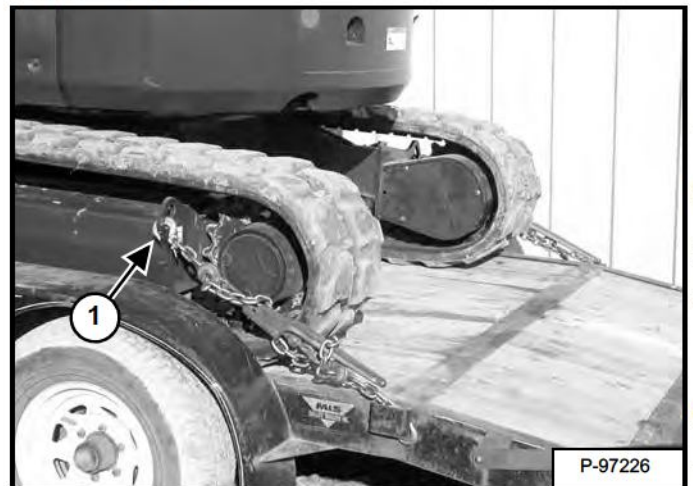

Figure 10-40-3



Fasten chains to the front corners of the blade (Item 1) [Figure 10-40-2] and to the tie down loop at both sides of the track frame (Item 1) [Figure 10-40-3] to prevent it from moving when going up or down slopes or during sudden stops.

Use chain binders to tighten the chains and then safely tie the chain binder levers to prevent loosening.

## **WARNING**

**AVOID SERIOUS INJURY OR DEATH**  
Adequately designed ramps of sufficient strength are needed to support the weight of the machine when loading onto a transport vehicle. Wood ramps can break and cause personal injury.

W-2058-0807

Dealer Copy -- Not for Resale

## TAILGATE

### Opening And Closing



#### AVOID INJURY OR DEATH

Never service or adjust the machine when the engine is running unless instructed to do so in the manual.

W-2012-0497



Keep the rear door closed when operating the machine. Failure to do so could seriously injure a bystander.

W-2020-1285

Figure 10-40-1



Pull the latch (Item 1) [Figure 10-40-1] and open the tailgate.

Push firmly to close the tailgate.

**NOTE:** The tailgate can be locked using the start key.

## Adjusting The Latch

Figure 10-50-1

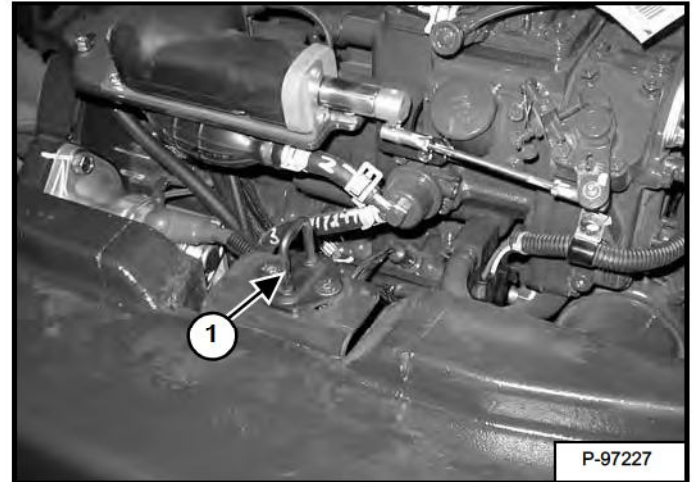

The tailgate latch (Item 1) [Figure 10-50-1] can be adjusted by loosening the two bolts, moving the latch, and tightening the two bolts.

Close the tailgate before operating the excavator.

Dealer Copy -- Not for Resale



**Suggest:**

**If the above button click is invalid.**

**Please download this document**

**first, and then click the above link**

**to download the complete manual.**

**Thank you so much for reading**

## RIGHT SIDE COVER

### Opening And Closing

Figure 10-60-1

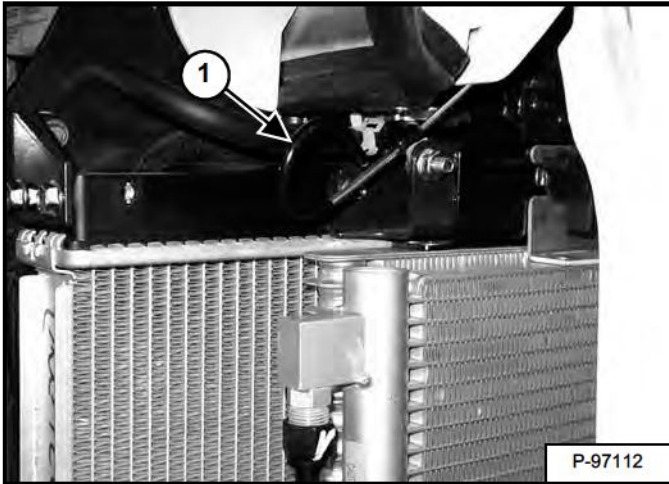

Open the tailgate to access the right side cover latch (Item 1) [Figure 10-60-1].

Pull the latch handle (Item 1) [Figure 10-60-1] out until the right side cover is unlatched.

Figure 10-60-2

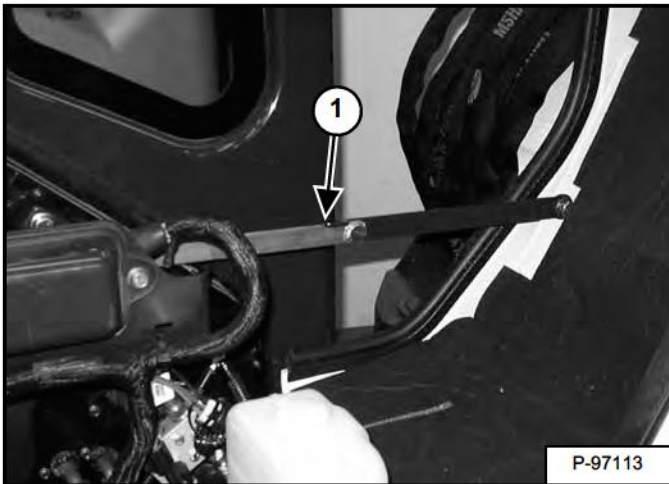

Raise the right side cover and rotate forward until it is held open by the retainer (Item 1) [Figure 10-60-2].

To close the right side cover, lift up on the retainer (Item 1) [Figure 10-60-2] while raising the right side cover. Rotate the cover back until it is in the fully closed position. Secure the right side cover with the latch (Item 1) [Figure 10-60-1].

**<https://www.ebooklibonline.com>**

Hello dear friend!

Thank you very much for reading.

Enter the link into your browser.

The full manual is available for immediate download.

**<https://www.ebooklibonline.com>**