

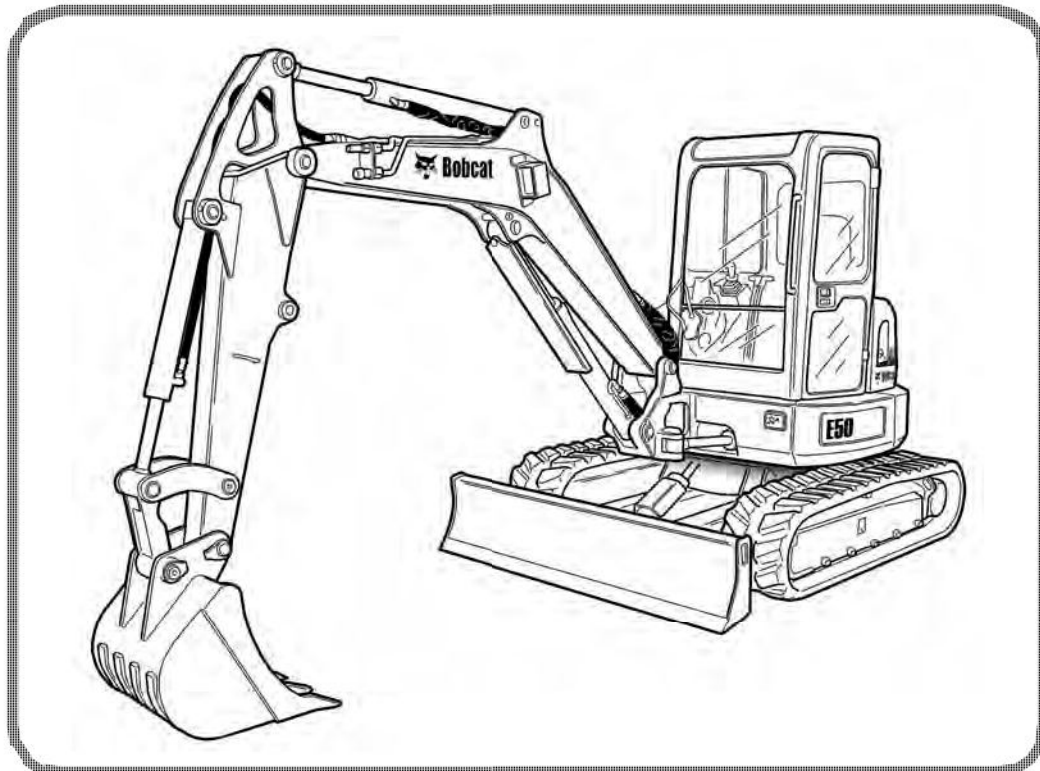

Bobcat®

Service Manual E50 Compact Excavator

S/N AG3N11001 & Above
S/N AHHE11001 & Above



Dealer Copy -- Not for Resale



MAINTENANCE SAFETY



WARNING

Instructions are necessary before operating or servicing machine. Read and understand the Operation & Maintenance Manual, Operator's Handbook and signs (decals) on machine. Follow warnings and instructions in the manuals when making repairs, adjustments or servicing. Check for correct function after adjustments, repairs or service. Untrained operators and failure to follow instructions can cause injury or death. W-2003-0807



Safety Alert Symbol: This symbol with a warning statement, means: "Warning, be alert! Your safety is involved!" Carefully read the message that follows.

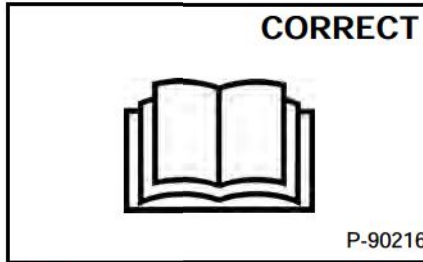

⚠ Never service the machine without instructions.

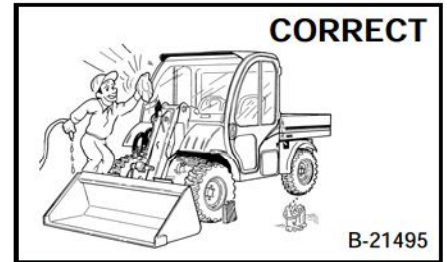

⚠ Cleaning and maintenance are required daily.

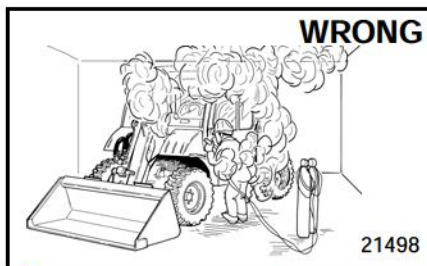

- ⚠ Have good ventilation when welding or grinding painted parts.
- ⚠ Wear dust mask when grinding painted parts. Toxic dust and gas can be produced.
- ⚠ Avoid exhaust fume leaks which can kill without warning. Exhaust system must be tightly sealed.

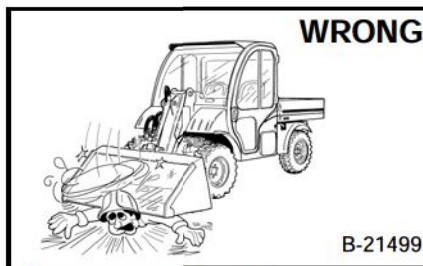

⚠ Disconnecting or loosening any hydraulic tubeline, hose, fitting, component or a part failure can cause lift arm or cargo box to drop. Do not go under lift arm or cargo box when raised unless supported by an approved lift arm or cargo box support device. Replace it if damaged.

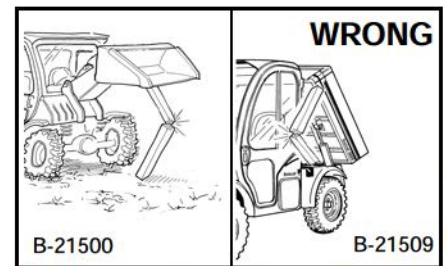

- ⚠ Never work on the machine with lift arm or cargo box up unless supported by an approved support device. Replace if damaged.
- ⚠ Never modify equipment or add attachments not approved by Bobcat Company.

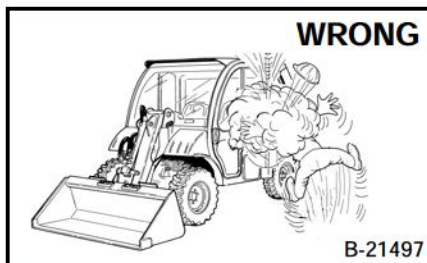

- ⚠ Stop, cool and clean engine of flammable materials before checking fluids.
- ⚠ Never service or adjust machine with the engine running unless instructed to do so in the manual.
- ⚠ Avoid contact with leaking hydraulic fluid or diesel fuel under pressure. It can penetrate the skin or eyes.
- ⚠ Never fill fuel tank with engine running, while smoking or when near open flame.

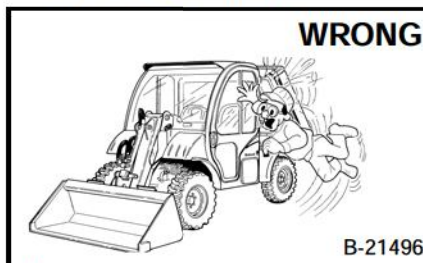

- ⚠ Keep body, jewelry and clothing away from moving parts, electrical contact, hot parts and exhaust.
- ⚠ Wear eye protection to guard from battery acid, compressed springs, fluids under pressure and flying debris when engines are running or tools are used. Use eye protection approved for type of welding.
- ⚠ Keep side access doors closed except for service.



- ⚠ Lead-acid batteries produce flammable and explosive gases.
- ⚠ Keep arcs, sparks, flames and lighted tobacco away from batteries.
- ⚠ Batteries contain acid which burns eyes or skin on contact. Wear protective clothing. If acid contacts body, flush well with water. For eye contact, flush well and get immediate medical attention.

Maintenance procedures which are given in the Operation & Maintenance Manual can be performed by the owner/operator without any specific technical training. Maintenance procedures which are **not** in the Operation & Maintenance Manual must be performed **ONLY BY QUALIFIED BOBCAT SERVICE PERSONNEL**. Always use genuine Bobcat replacement parts.

Dealer Copy -- Not for Resale

MSW25-0409

CONTENTS

SAFETY AND MAINTENANCE	10-01
HYDRAULIC SYSTEM	20-01
UNDERCARRIAGE	30-01
UPPERSTRUCTURE AND SWING SECTION	40-01
ELECTRICAL SYSTEM AND ANALYSIS	50-01
ENGINE SERVICE	60-01
HEATING, VENTILATION AND AIR CONDITIONING S/N AG3N11001 - AG3N13999 AND AHHE11001 - AHHE13999	70-01
HEATING, VENTILATION AND AIR CONDITIONING S/N AG3N14000 & ABOVE AND AHHE14000 & ABOVE	71-01
SPECIFICATIONS	SPEC-01
ALPHABETICAL INDEX	INDEX-01

Dealer Copy -- Not for Resale

FOREWORD

FOREWORD	1-7
SAFETY INSTRUCTIONS	1-9
FIRE PREVENTION	1-11
Maintenance	1-11
Operation	1-11
Electrical	1-11
Hydraulic System	1-11
Fueling	1-11
Starting	1-11
Spark Arrestor Exhaust System	1-11
Welding And Grinding	1-12
Fire Extinguishers	1-12
SERIAL NUMBER LOCATIONS	1-13
Excavator Serial Number	1-13
Engine Serial Number	1-13
DELIVERY REPORT	1-14
EXCAVATOR IDENTIFICATION	1-15

<https://www.ebooklibonline.com>

Hello dear friend!

Thank you very much for reading.

Enter the link into your browser.

The full manual is available for immediate download.

<https://www.ebooklibonline.com>

FOREWORD

This manual is for the Bobcat excavator mechanic. It provides necessary servicing and adjustment procedures for the Bobcat excavator and its component parts and systems. Refer to the Operation & Maintenance Manual for operating instructions, starting procedure, daily checks, etc.

A general inspection of the following items must be made after the excavator has had service or repair:

1. Check that the ROPS/TOPS/FOPS is in good condition and is not modified.



2. Check that ROPS/TOPS mounting hardware is tightened and is Bobcat approved.



3. The seat belt must be correctly installed, functional and in good condition.



4. Machine signs (decals) must be legible and in the correct location.



5. Travel levers, control levers and foot pedals must return to neutral. Check that the pedal locks are in working order.

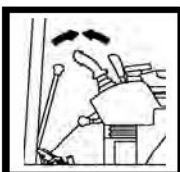

6. Check for correct function of the work lights.



7. Enclosure door latches must open and close freely.

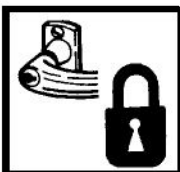

8. Attachment locking pins must function correctly and be in good condition.

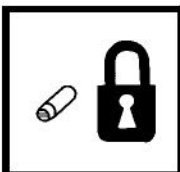

9. Safety treads must be in good condition.

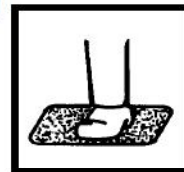

10. Check for correct function of indicator lamps.

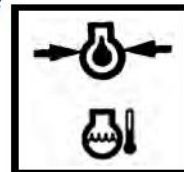

11. Check hydraulic fluid level, engine oil level and fuel supply.



12. Inspect for fuel, oil or hydraulic fluid leaks.



13. Lubricate the excavator.



14. Check the condition of the battery and cables.

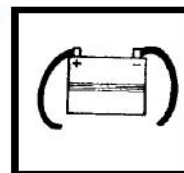

15. Inspect the air cleaner for damage or leaks. Check the condition of the element.

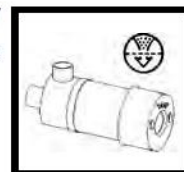

16. Check the electrical charging system.

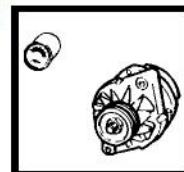

Dealer Copy -- Not for Resale

FW EXC-0509 SM

17. Check tracks for wear and tension. Use only approved tracks.

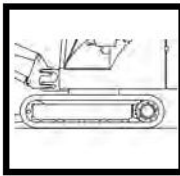

21. Check the control console interlocks for correct function.



18. Inspect for loose or broken parts or connections.



22. Inspect the X-Change™ for wear or damage. Repair or replace damaged parts.

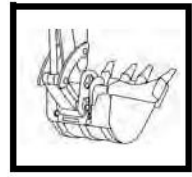

19. Check for any field modification not completed.



23. Check function or condition of all equipped options and accessories (examples: special applications kit, motion alarm, etc.).



20. Operate the machine and check all functions.



24. Recommend to the owner that all necessary corrections be made before the machine is returned to service.



**CALIFORNIA
PROPOSITION 65 WARNING**
Diesel engine exhaust and some of its constituents are known to the state of California to cause cancer, birth defects and other reproductive harm.

SAFETY INSTRUCTIONS

 Safety Alert Symbol
This symbol with a warning statement means: "Warning, be alert! Your safety is involved!" Carefully read the message that follows.



AVOID INJURY OR DEATH

Instructions are necessary before operating or servicing machine. Read and understand the Operation & Maintenance Manual, Operator's Handbook and signs (decals) on machine. Follow warnings and instructions in the manuals when making repairs, adjustments or servicing. Check for correct function after adjustments, repairs or service. Untrained operators and failure to follow instructions can cause injury or death.

W-2003-0807



This notice identifies procedures which must be followed to avoid damage to the machine.

I-2019-0284



The signal word DANGER on the machine and in the manuals indicates a hazardous situation which, if not avoided, will result in death or serious injury.

D-1002-1107



The signal word WARNING on the machine and in the manuals indicates a potentially hazardous situation which, if not avoided, could result in death or serious injury.

W-2044-1107

The following publications provide information on the safe use and maintenance of the Bobcat machine and attachments:

- The Delivery Report is used to assure that complete instructions have been given to the new owner and that the machine is in safe operating condition.
- The Operation & Maintenance Manual delivered with the machine or attachment contains operating information as well as routine maintenance and service procedures. It is a part of the machine and can be stored in a container provided on the machine. Replacement Operation & Maintenance Manuals can be ordered from your Bobcat dealer.
- Machine signs (decals) instruct on the safe operation and care of your Bobcat machine or attachment. The signs and their locations are shown in the Operation & Maintenance Manual. Replacement signs are available from your Bobcat dealer.
- An Operator's Handbook fastened to the operator cab. It's brief instructions are convenient to the operator. The handbook is available from your dealer in an English edition or one of many other languages. See your Bobcat dealer for more information on translated versions.
- The Service Manual and Parts Manual are available from your dealer for use by mechanics to do shop-type service and repair work.
- The Utility Work Machine Operator Training Course is available through your local dealer or at www.training.bobcat.com or www.bobcat.com. This course is intended to provide rules and practices of correct operation of the utility work machine. The course is available in English and Spanish versions.
- The Utility Work Machine Safety Video is available from your Bobcat dealer or at www.training.bobcat.com or www.bobcat.com.

Dealer Copy -- Not for Resale

SI TC-0913 SM

FIRE PREVENTION



Maintenance

The machine and some attachments have components that are at high temperatures under normal operating conditions. The primary source of high temperatures is the engine and exhaust system. The electrical system, if damaged or incorrectly maintained, can be a source of arcs or sparks.

Flammable debris (leaves, straw, etc.) must be removed regularly. If flammable debris is allowed to accumulate, it can cause a fire hazard. Clean often to avoid this accumulation. Flammable debris in the engine compartment is a potential fire hazard.

The operator's area, engine compartment and engine cooling system must be inspected every day and cleaned if necessary to prevent fire hazards and overheating.

All fuels, most lubricants and some coolants mixtures are flammable. Flammable fluids that are leaking or spilled onto hot surfaces or onto electrical components can cause a fire.

Operation

Do not use the machine where exhaust, arcs, sparks or hot components can contact flammable material, explosive dust or gases.

Electrical



Check all electrical wiring and connections for damage. Keep the battery terminals clean and tight. Repair or replace any damaged part or wires that are loose or frayed.

Battery gas can explode and cause serious injury. Use the procedure in the Operation & Maintenance Manual for connecting the battery and for jump starting. Do not jump start or charge a frozen or damaged battery. Keep any open flames or sparks away from batteries. Do not smoke in battery charging area.

Hydraulic System

Check hydraulic tubes, hoses and fittings for damage and leakage. Never use open flame or bare skin to check for leaks. Hydraulic tubes and hoses must be properly routed and have adequate support and secure clamps. Tighten or replace any parts that show leakage.

Always clean fluid spills. Do not use gasoline or diesel fuel for cleaning parts. Use commercial nonflammable solvents.

Fueling



Stop the engine and let it cool before adding fuel. No smoking! Do not refuel a machine near open flames or sparks. Fill the fuel tank outdoors.

Ultra Low Sulfur Diesel (ULSD) poses a greater static ignition hazard than earlier diesel formulations with higher Sulfur content. Avoid death or serious injury from fire or explosion. Consult with your fuel or fuel system supplier to ensure the delivery system is in compliance with fueling standards for proper grounding and bonding practices.

Starting

Do not use ether or starting fluids on any engine that has glow plugs. These starting aids can cause explosion and injure you or bystanders.

Use the procedure in the Operation & Maintenance Manual for connecting the battery and for jump starting.

Spark Arrester Exhaust System

The spark arrester exhaust system is designed to control the emission of hot particles from the engine and exhaust system, but the muffler and the exhaust gases are still hot.

Check the spark arrester exhaust system regularly to make sure it is maintained and working properly. Use the procedure in the Operation & Maintenance Manual for cleaning the spark arrester muffler (if equipped).

Dealer Copy -- Not for Resale

SI EXC-0913 SM

FIRE PREVENTION (CONT'D)

Welding And Grinding

Always clean the machine and attachment, disconnect the battery, and disconnect the wiring from the Bobcat controllers before welding. Cover rubber hoses, battery and all other flammable parts. Keep a fire extinguisher near the machine when welding.

Have good ventilation when grinding or welding painted parts. Wear dust mask when grinding painted parts. Toxic dust or gas can be produced.

Dust generated from repairing nonmetallic parts such as hoods, fenders or covers can be flammable or explosive. Repair such components in a well ventilated area away from open flames or sparks.

Fire Extinguishers



Know where fire extinguishers and first aid kits are located and how to use them. Inspect the fire extinguisher and service the fire extinguisher regularly. Obey the recommendations on the instructions plate.

SERIAL NUMBER LOCATIONS

Always use the serial number of the excavator when requesting service information or when ordering parts. Early or later models (identification made by serial number) may use different parts, or it may be necessary to use a different procedure in doing a specific service operation.

Excavator Serial Number

Figure 1

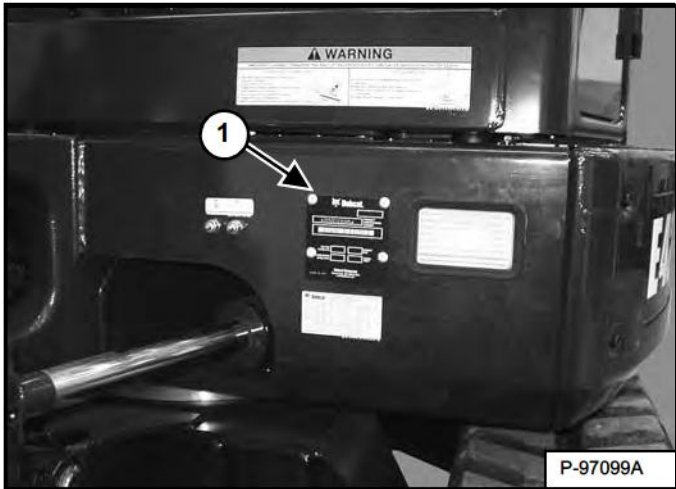

The excavator serial number plate (Item 1) [Figure 1] is located on the frame of the machine in the location shown.

Figure 2

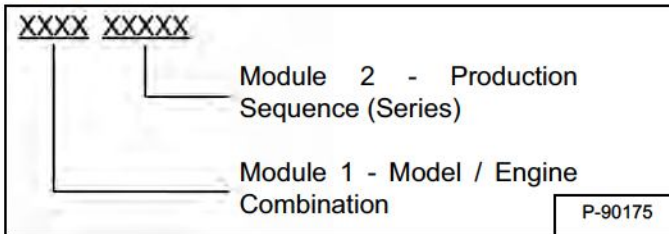

Explanation of excavator Serial Number [Figure 2]:

1. The four digit Model / Engine Combination Module number identifies the model number and engine combination.
2. The five digit Production Sequence Number identifies the order which the excavator is produced.

Engine Serial Number

Figure 3

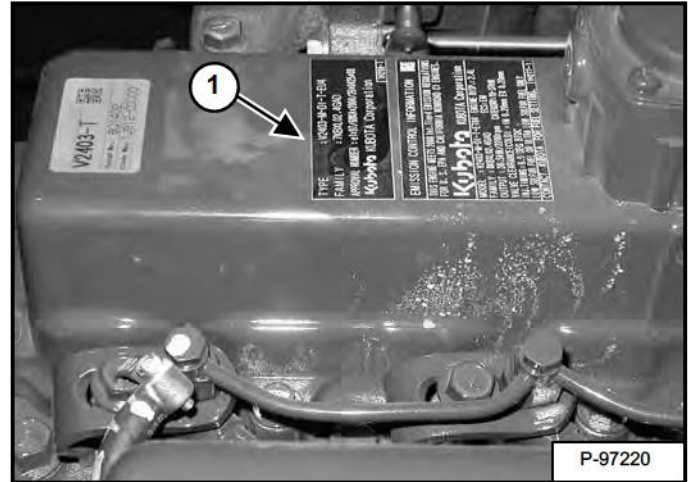

The engine serial number (Item 1) [Figure 3] is located on the top cover.

DELIVERY REPORT

Figure 4

The diagram shows a form titled "DELIVERY REPORT". The form is divided into several sections. At the top right, there is a header box labeled "DELIVERY REPORT". Below this, the form is split into two columns. The left column contains a section with a black header labeled "WARNING" and several lines of text below it. The right column contains a large area with many horizontal lines, representing text input fields. At the bottom right of the form, there is a small box containing the alphanumeric code "B-16315".

The delivery report [Figure 4] must be completed by the dealer and signed by the owner or operator when the Bobcat excavator is delivered. An explanation of the form must be given to the owner. Make sure it is filled out completely.

EXCAVATOR IDENTIFICATION

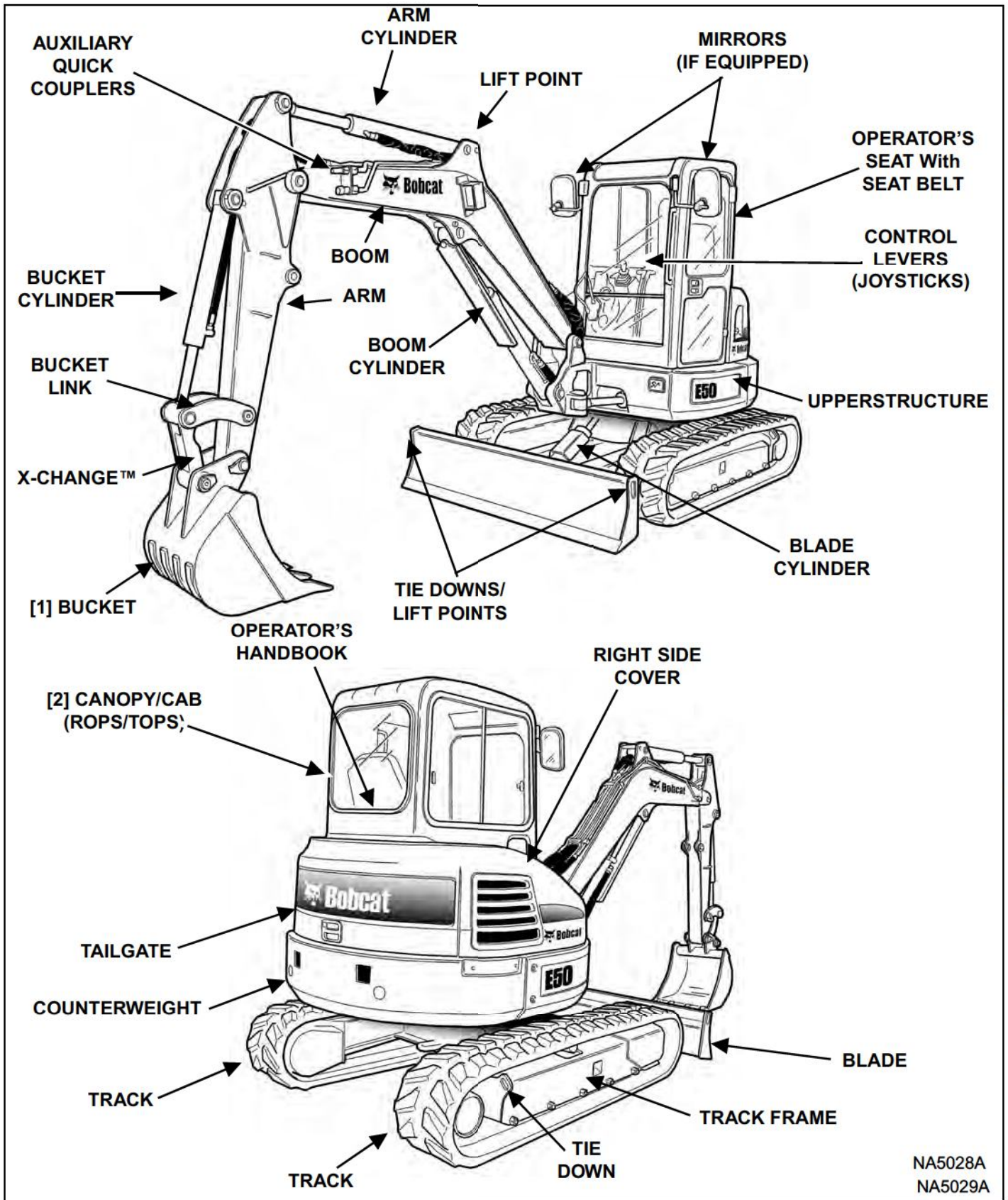

- [1] BUCKET - Several different buckets and other attachments are available for the Bobcat excavator.
- [2] ROPS / TOPS - (Roll-Over Protective Structure / Tip-Over Protective Structure) as standard equipment. The ROPS / TOPS meets ISO 12117-2 and ISO 12117.

Dealer Copy -- Not for Resale

NA5028A
NA5029A

SAFETY AND MAINTENANCE

LIFTING AND BLOCKING THE EXCAVATOR	10-10-1
Procedure	10-10-1
LIFTING THE EXCAVATOR	10-20-1
Procedure	10-20-1
OPERATOR CAB (ROPS / TOPS)	10-30-1
Description	10-30-1
Cab Door	10-30-2
Front Window	10-30-3
Front Wiper	10-30-4
Window Washer Reservoir	10-30-4
Right Side Windows	10-30-5
OPERATOR CANOPY (ROPS / TOPS)	10-31-1
Description	10-31-1
TRANSPORTING THE EXCAVATOR ON A TRAILER	10-40-1
Loading And Unloading	10-40-1
Fastening	10-40-1
TAILGATE	10-50-1
Opening And Closing	10-50-1
Adjusting The Latch	10-50-1
RIGHT SIDE COVER	10-60-1
Opening And Closing	10-60-1
SERVICE SCHEDULE	10-70-1
Maintenance Intervals	10-70-1
AIR CLEANER SERVICE	10-80-1
Daily Check	10-80-1
Replacing The Filter Elements	10-80-1
CAB FILTERS (S/N AG3N11001 - AG3N13999 AND AHHE11001 - AHHE13999)	10-90-1
Cleaning And Maintenance	10-90-1
CAB FILTERS (S/N AG3N14000 & ABOVE AND AHHE14000 & ABOVE)	10-91-1
Cleaning And Maintenance	10-91-1
ENGINE COOLING SYSTEM	10-100-1
Cleaning	10-100-1
Checking Level	10-100-2
Removing And Replacing Coolant	10-100-3

Dealer Copy -- Not for Resale

FUEL SYSTEM	10-110-1
Fuel Specifications	10-110-1
Biodiesel Blend Fuel	10-110-1
Filling The Fuel Tank	10-110-2
Fuel Filters	10-110-3
Draining The Fuel Tank	10-110-3
Removing Air From The Fuel System	10-110-4
ENGINE LUBRICATION SYSTEM	10-120-1
Checking And Adding Engine Oil	10-120-1
Engine Oil Chart	10-120-1
Removing And Replacing Oil And Filter	10-120-2
HYDRAULIC SYSTEM	10-130-1
Checking And Adding Hydraulic Fluid	10-130-1
Hydraulic / Hydrostatic Fluid Chart	10-130-2
Removing And Replacing The Hydraulic Filters	10-130-2
Removing And Replacing The Hydraulic Fluid	10-130-4
LUBRICATING THE EXCAVATOR	10-140-1
Lubrication Locations	10-140-1
PIVOT PINS	10-150-1
Inspection And Maintenance	10-150-1
TRAVEL MOTOR	10-160-1
Checking And Adding Oil	10-160-1
Removing And Replacing Oil	10-160-1
SPARK ARRESTER MUFFLER	10-170-1
Cleaning Procedure	10-170-1
EMERGENCY EXIT	10-180-1
Right Side Rear Window	10-180-1
Front Window	10-180-1
SEAT BELT	10-190-1
Inspection And Maintenance	10-190-1
CONTROL CONSOLE LOCKOUTS	10-200-1
Inspection And Maintenance	10-200-1
TOWING THE EXCAVATOR	10-210-1
Procedure	10-210-1
REMOTE START TOOL KIT - MEL1563	10-220-1
Remote Start Tool - MEL1563	10-220-1
Service Tool Harness Communicator - MEL1566	10-220-3

REMOTE START TOOL (SERVICE TOOL) KIT - 7217666	10-221-1
Description	10-221-1
Remote Start Tool (Service Tool) - 7022042	10-221-2
Excavator Service Tool Harness - 6689747	10-221-3
Computer Service Tool Harness - 6689746	10-221-4

Dealer Copy -- Not for Resale

LIFTING AND BLOCKING THE EXCAVATOR

Procedure

Always park the machine on a level surface.



AVOID INJURY OR DEATH

Instructions are necessary before operating or servicing machine. Read and understand the Operation & Maintenance Manual, Operator's Handbook and signs (decals) on machine. Follow warnings and instructions in the manuals when making repairs, adjustments or servicing. Check for correct function after adjustments, repairs or service. Untrained operators and failure to follow instructions can cause injury or death.

W-2003-0807



Put jackstands under the front axles and rear corners of the frame before running the engine for service. Failure to use jackstands can allow the machine to fall or move and cause injury or death.

W-2017-0286

Figure 10-10-1

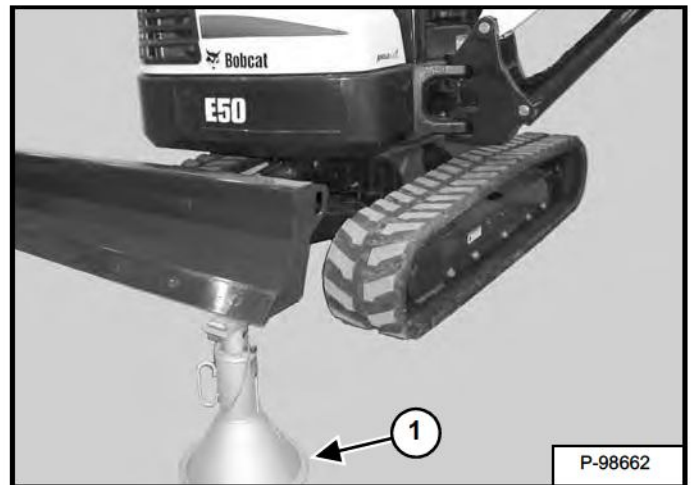
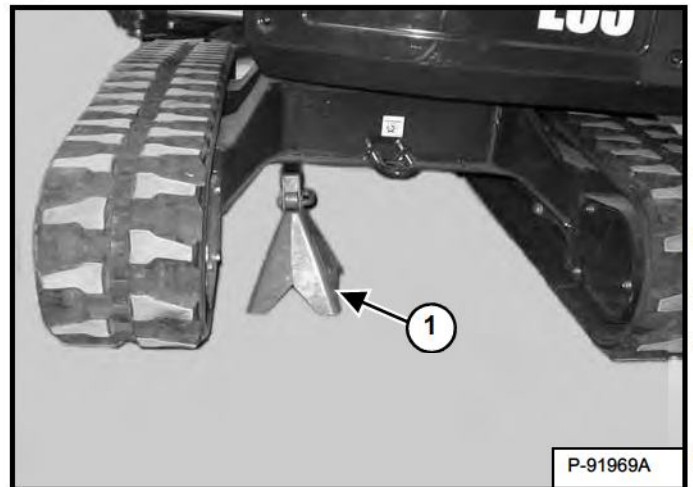

Figure 10-10-2



Raise one side of the machine approximately 101,6 mm (4 in) using the boom and arm [Figure 10-10-1] and [Figure 10-10-2].

Raise the blade fully and install jack stands under the blade and track frame (Item 1) [Figure 10-10-1] and [Figure 10-10-2]. Raise the boom until all machine weight is on the jack stands.

Repeat the procedure for the other side.

Stop the engine.

Dealer Copy -- Not for Resale

LIFTING THE EXCAVATOR

Procedure

Figure 10-20-1

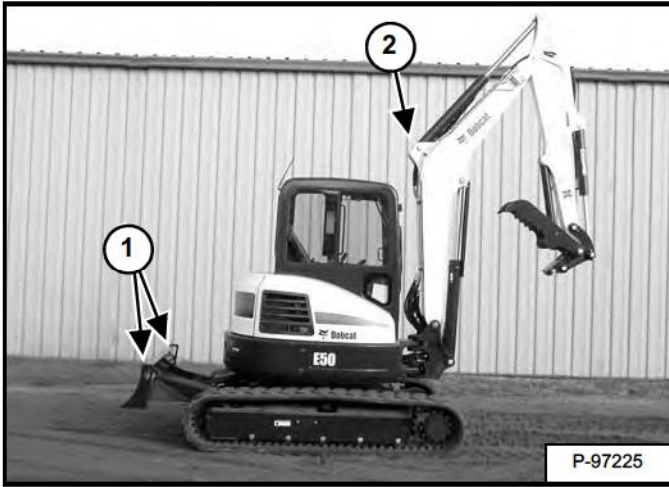

Fully extend the cylinders of the bucket, arm, and boom so that the excavator is in the position as shown [Figure 10-20-1].

Raise the blade all the way.

Put all the control levers in neutral.

NOTE: For machines equipped with the angle blade feature, make sure the blade is in the straight position prior to lifting.

WARNING

AVOID INJURY OR DEATH

- Use chains and lifting equipment with sufficient capacity for the weight of the excavator plus any added attachments.
- Maintain center of gravity and balance when lifting.
- Do not swing boom or upperstructure. Engage the upperstructure slew lock.
- Never lift with operator on machine.
- Never lift with the blade angled (if equipped).

W-2580-0607

Figure 10-20-2

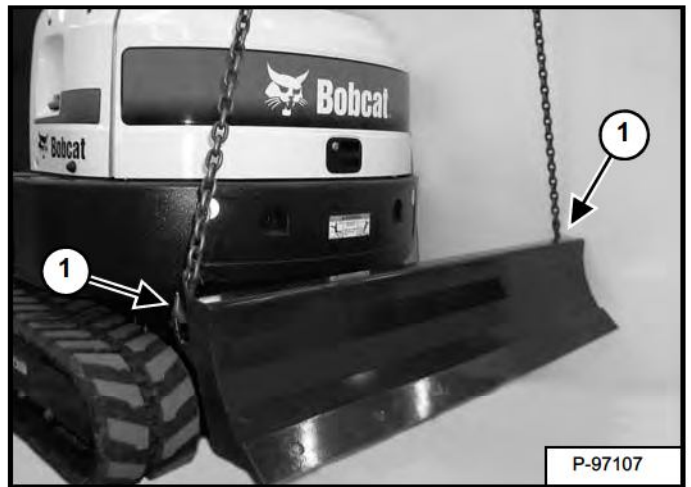
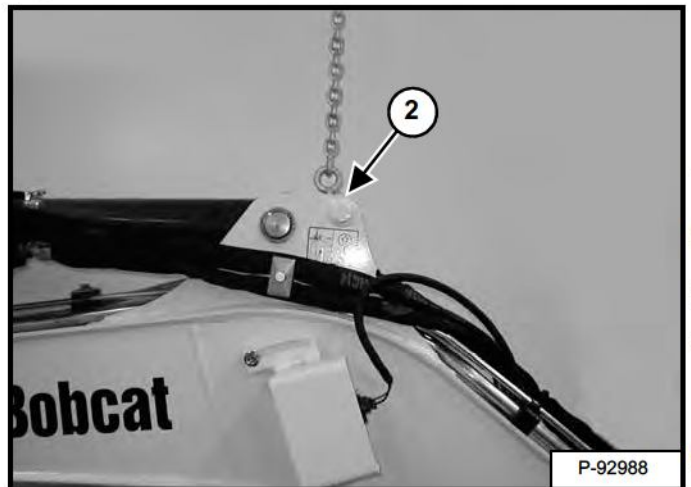

Figure 10-20-3



Fasten chains to the ends of the blade (Item 1) [Figure 10-20-1] and [Figure 10-20-2] and up to a lifting fixture above the cab. The lifting fixture must extend over the sides of the cab to prevent the chains from hitting the ROPS / TOPS.

Fasten a chain (Item 2) [Figure 10-20-1] and [Figure 10-20-3] from the rod to the lift fixture.

Dealer Copy -- Not for Resale

OPERATOR CAB (ROPS / TOPS)

Description

The Bobcat excavator has an optional operator cab (ROPS / TOPS) as standard equipment to protect the operator if the excavator is tipped over. The seat belt must be worn for ROPS / TOPS protection.

Check the ROPS / TOPS cab, mounting, and hardware for damage. Never modify the ROPS / TOPS cab. Replace the cab and hardware if damaged.

ROPS / TOPS - Roll-Over Protective Structure per ISO 12117-2, and Tip-Over Protective Structure per ISO 12117.



Never modify operator cab by welding, grinding, drilling holes or adding attachments unless instructed to do so by Bobcat Company. Changes to the cab can cause loss of operator protection from rollover and falling objects, and result in injury or death.

W-2069-0200

OPERATOR CAB (ROPS / TOPS) (CONT'D)

Cab Door

Figure 10-30-1

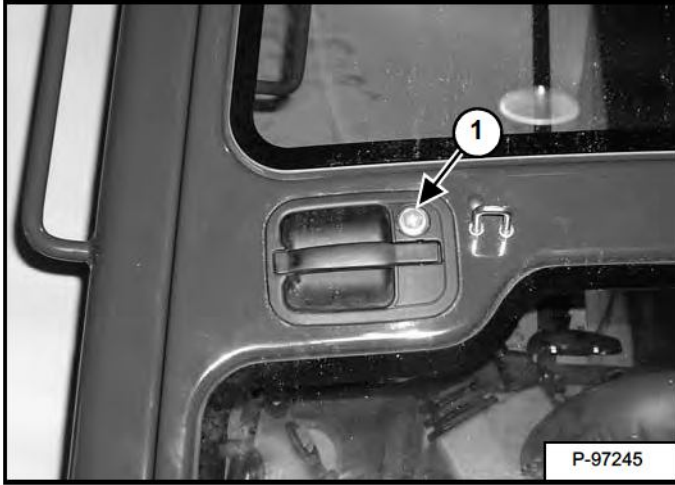

The cab door can be locked (Item 1) [Figure 10-30-1] with the same key as the starter switch.

Figure 10-30-2

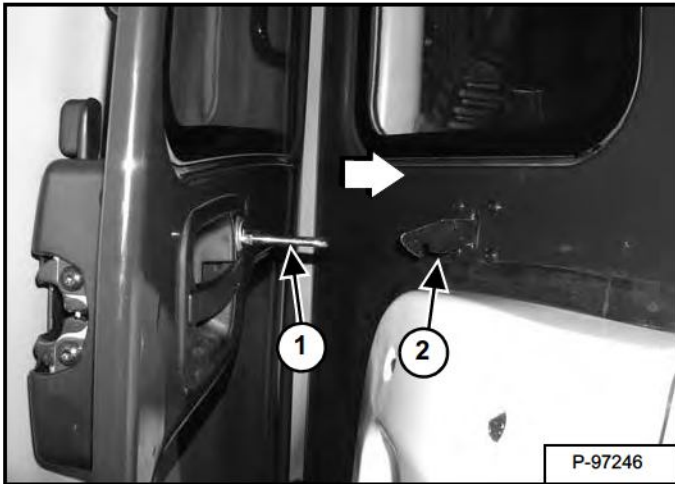

Push the door all the way open until the latch post (Item 1) engages in the latch (Item 2) [Figure 10-30-2] to hold the door in the open position.

Figure 10-30-3

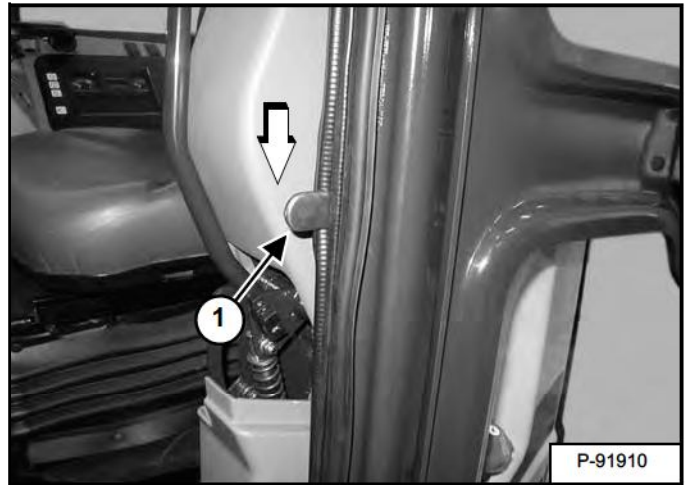

When the door is in the open position, push down on the latch (Item 1) [Figure 10-30-3] and close the door.

Figure 10-30-4

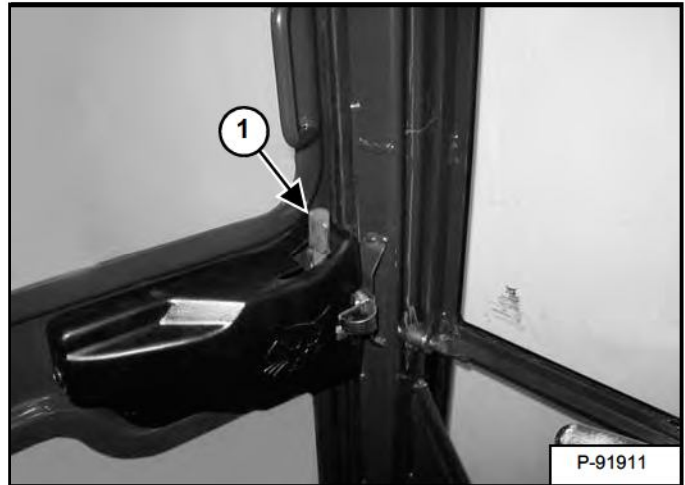

From inside the cab, open the door using handle (Item 1) [Figure 10-30-4].

OPERATOR CAB (ROPS / TOPS) (CONT'D)

Front Window

Opening The Front Window

Figure 10-30-5

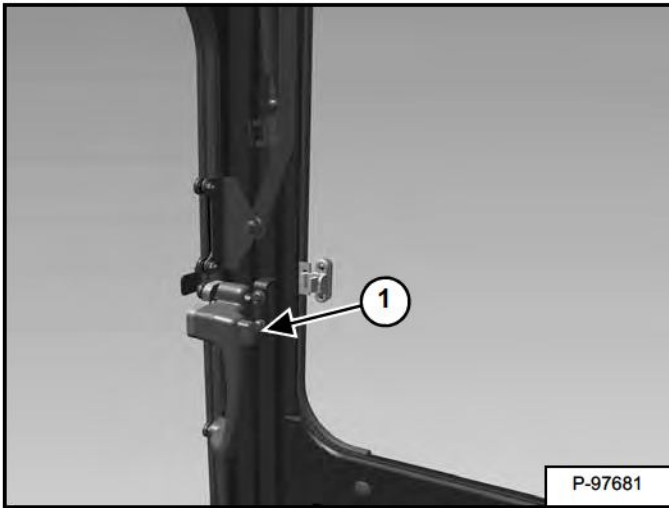

Press the top window latch (Item 1) [Figure 10-30-5] (both sides).

Figure 10-30-6



Use both window grab handles (Item 1) [Figure 10-30-6] to pull the top of the window in.

Continue moving the window in and up over the operator's head until the window is fully raised.

Figure 10-30-7

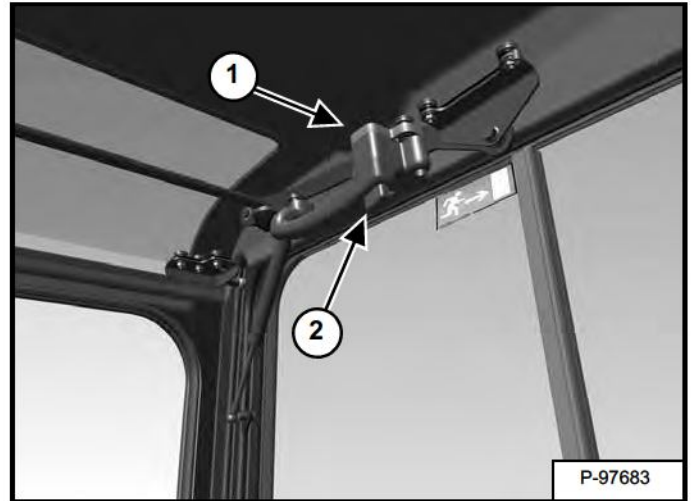

When the window is fully raised, the latch (Item 1) [Figure 10-30-7] (both sides) will close on the bracket in the latched position.

Pull down slightly on the window to make sure it is fully latched.

Closing The Front Window

Use both window grab handles to support the window while pressing the window latch button (Item 2) [Figure 10-30-7] (both sides).

Use both window grab handles (Item 1) [Figure 10-30-6] to pull the window down fully.

Press the top of the window in until the latch locks into the latched position (both sides) [Figure 10-30-5].

Pull inward and upward slightly on the window to make sure it is fully latched in the closed position.

Dealer Copy -- Not for Resale

OPERATOR CAB (ROPS / TOPS) (CONT'D)

Front Wiper

Figure 10-30-8



The front window is equipped with a wiper (Item 1) [Figure 10-30-8] and washer.

Window Washer Reservoir

Figure 10-30-9

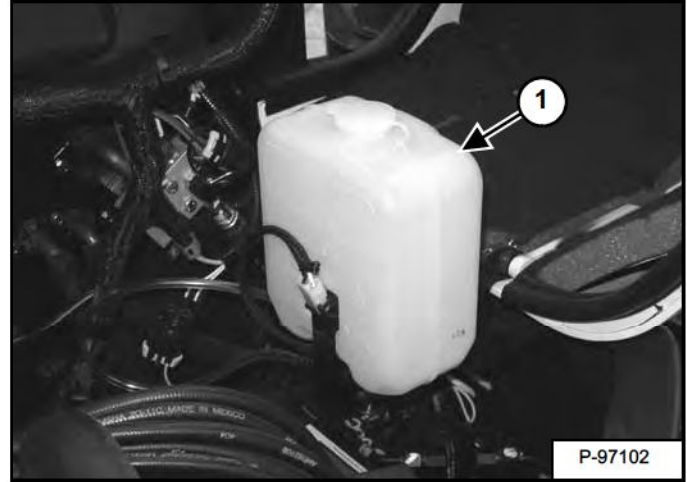

The window washer reservoir (Item 1) [Figure 10-30-9] is located under the right side cover.

OPERATOR CAB (ROPS / TOPS) (CONT'D)

Right Side Windows

Opening The Right Rear Window

Figure 10-30-10

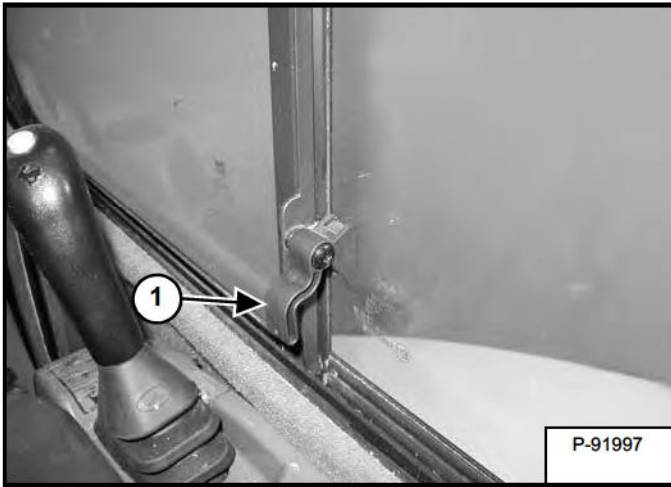

Raise the latch (Item 1) [Figure 10-30-10] located at the rear of the front window.

Figure 10-30-11

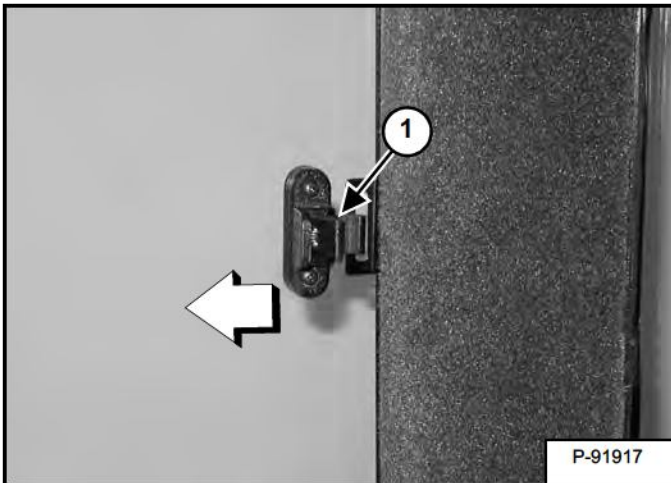

Pull out on the latch (Item 1) [Figure 10-30-11].

Figure 10-30-12

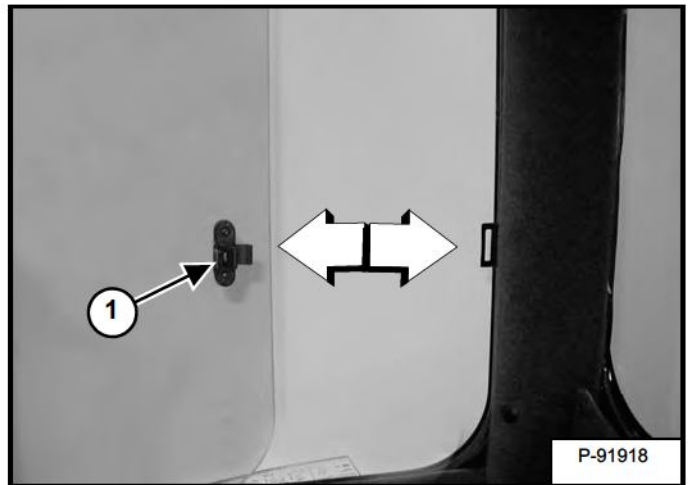

Pull the latch (Item 1) [Figure 10-30-12] forward to open the window. When the window is in the open position, push down on the latch (Item 1) [Figure 10-30-10].

Closing The Right Rear Window

Raise the latch (Item 1) [Figure 10-30-10].

Push the latch (Item 1) [Figure 10-30-12] back to close the window. Rotate the latch (Item 1) [Figure 10-30-10] down.

Dealer Copy -- Not for Resale

OPERATOR CAB (ROPS / TOPS) (CONT'D)

Right Side Windows (Cont'd)

Opening The Right Front Window

Figure 10-30-13

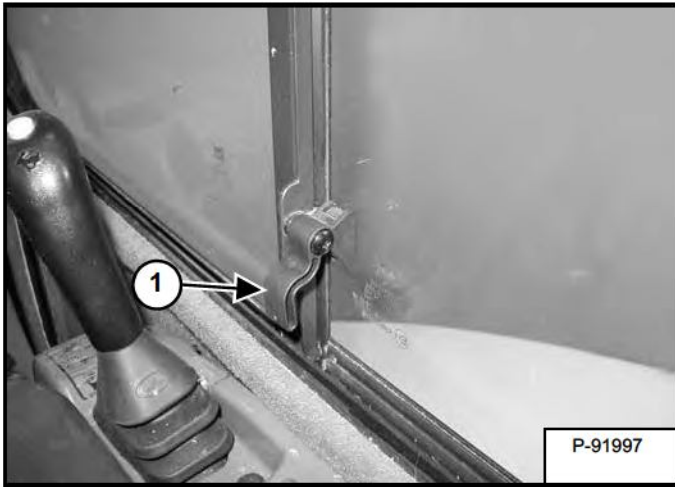

Raise the latch (Item 1) [Figure 10-30-13] located at the rear of the front window.

Figure 10-30-14

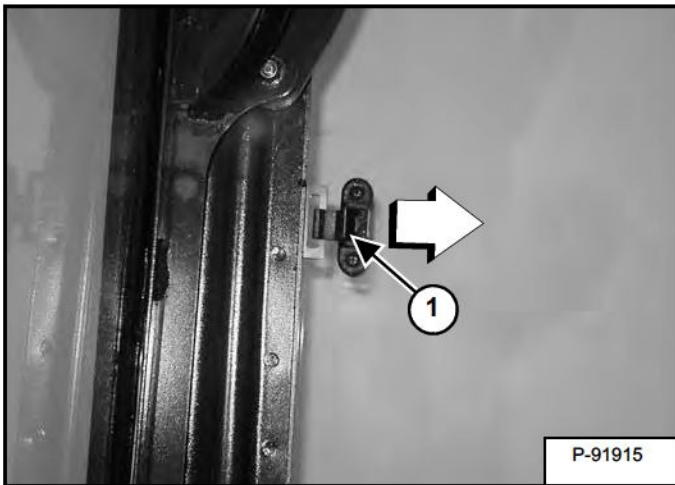

Pull back on the latch (Item 1) [Figure 10-30-14].

Figure 10-30-15

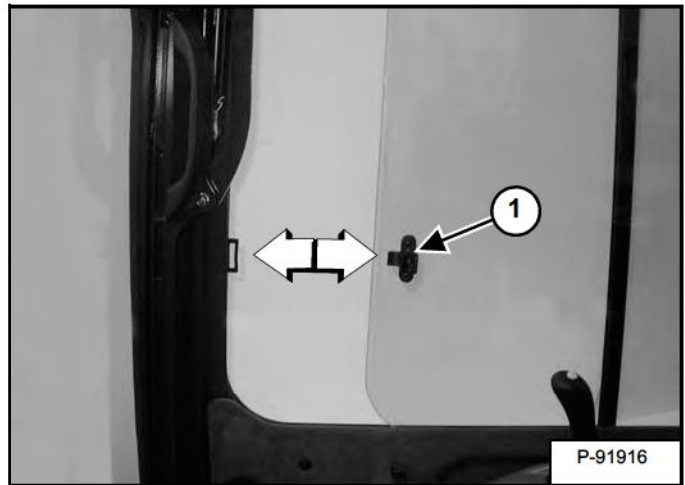

Pull the latch (Item 1) [Figure 10-30-15] back to open the window.

When the window is in the open position, push down on the latch (Item 1) [Figure 10-30-13].

Closing The Right Front Window

Raise the latch (Item 1) [Figure 10-30-13].

Push the handle (Item 1) [Figure 10-30-15] forward to close the window. Rotate the latch (Item 1) [Figure 10-30-13] down.

OPERATOR CANOPY (ROPS / TOPS)

Description

The Bobcat excavator has an operator canopy (ROPS / TOPS) as standard equipment to protect the operator if the excavator is tipped over. The seat belt must be worn for ROPS / TOPS protection.

Check the ROPS / TOPS canopy, mounting, and hardware for damage. Never modify the ROPS / TOPS canopy. Replace the canopy and hardware if damaged.

ROPS / TOPS - Roll-Over Protective Structure per ISO 12117-2, and Tip-Over Protective Structure per ISO 12117.



Never modify operator cab by welding, grinding, drilling holes or adding attachments unless instructed to do so by Bobcat Company. Changes to the cab can cause loss of operator protection from rollover and falling objects, and result in injury or death.

W-2069-0200

TRANSPORTING THE EXCAVATOR ON A TRAILER

Loading And Unloading

When transporting the machine, observe the rules, motor vehicle laws, and vehicle limit ordinances. Use a transport and towing vehicle of adequate length and capacity.

Secure the parking brakes and block the wheels of the transport vehicle.

Align the ramps with the center of the transport vehicle. Secure the ramps to the truck bed and be sure ramp angle does not exceed 15 degrees.

Use metal loading ramps with a slip resistant surface.

Use ramps that are the correct length and width and can support the weight of the machine.

The rear of the trailer must be blocked or supported when loading or unloading the machine to prevent the front of the transport vehicle from raising.

Determine the direction of the track movement before moving the machine (blade forward).

Disengage the auto idle feature and move the two speed travel to the low range position.

Figure 10-40-1



Move the machine forward onto the transport vehicle [Figure 10-40-1].

Do not change direction of the machine while it is on the ramps.

Lower the boom, arm, bucket, and blade to the transport vehicle.

Stop the engine and remove the key (if equipped).

Put blocks at the front and rear of the tracks.

Fastening

Figure 10-40-2

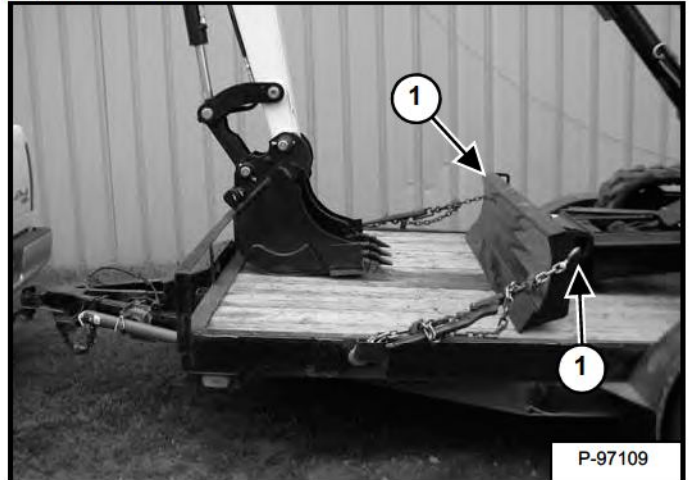
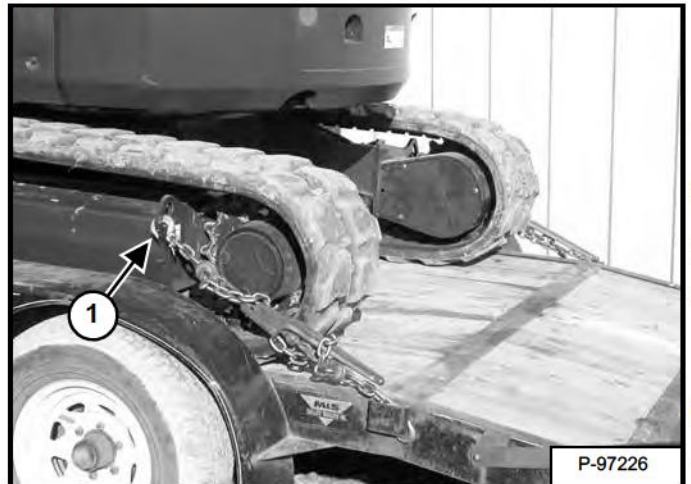

Figure 10-40-3



Fasten chains to the front corners of the blade (Item 1) [Figure 10-40-2] and to the tie down loop at both sides of the track frame (Item 1) [Figure 10-40-3] to prevent it from moving when going up or down slopes or during sudden stops.

Use chain binders to tighten the chains and then safely tie the chain binder levers to prevent loosening.

WARNING

AVOID SERIOUS INJURY OR DEATH
Adequately designed ramps of sufficient strength are needed to support the weight of the machine when loading onto a transport vehicle. Wood ramps can break and cause personal injury.

W-2058-0807

Dealer Copy -- Not for Resale



Suggest:

If the above button click is invalid.

Please download this document first, and then click the above link to download the complete manual.

Thank you so much for reading

TAILGATE

Opening And Closing

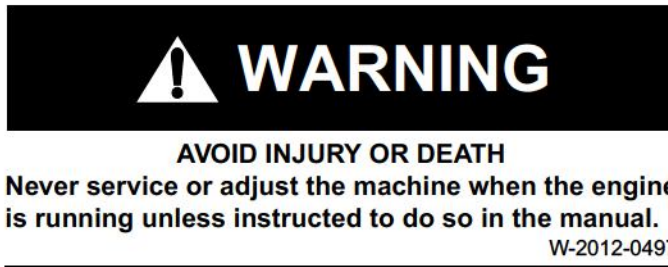

Figure 10-50-1



Pull the latch (Item 1) [Figure 10-50-1] and open the tailgate.

Push firmly to close the tailgate.

NOTE: The tailgate can be locked using the start key.

Adjusting The Latch

Figure 10-50-2

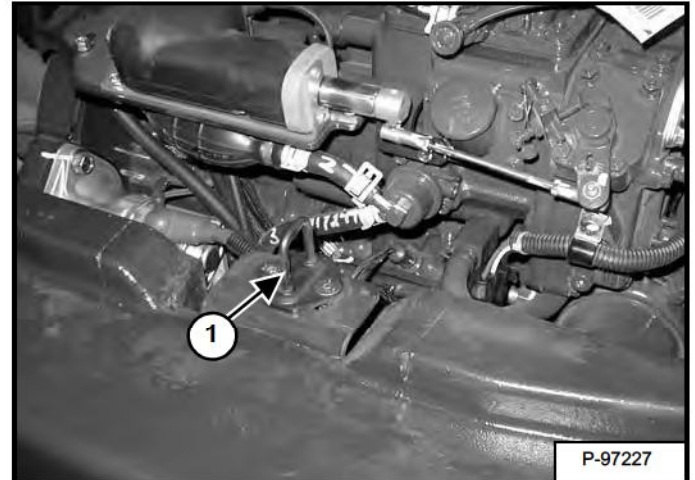

The tailgate latch (Item 1) [Figure 10-50-2] can be adjusted by loosening the two bolts, moving the latch, and tightening the two bolts.

Close the tailgate before operating the excavator.

<https://www.ebooklibonline.com>

Hello dear friend!

Thank you very much for reading.

Enter the link into your browser.

The full manual is available for immediate download.

<https://www.ebooklibonline.com>