



# Bobcat®

## Service Manual

### G Series

S/N 514140001 & Above  
S/N 514240001 & Above  
S/N 517911001 & Above

S/N 520111001 & Above  
S/N 520211001 & Above

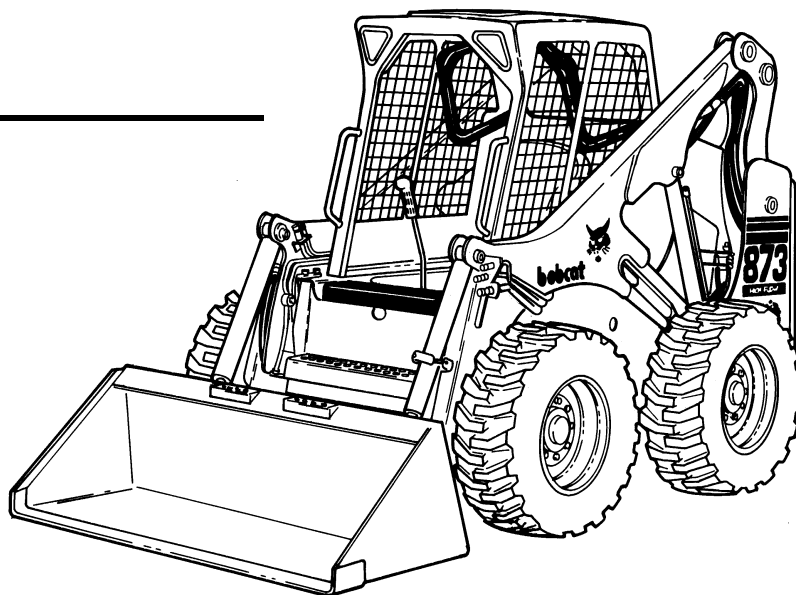

**TURBO**

**873**

**TURBO**

**883**

**INCLUDES HIGH FLOW**

**EQUIPPED WITH  
BOBCAT INTERLOCK  
CONTROL SYSTEM (BICS™)**

6900847 (2-06)



Printed in U.S.A.

© Bobcat Company 2006

# MAINTENANCE SAFETY



## WARNING

Instructions are necessary before operating or servicing machine. Read and understand the Operation & Maintenance Manual, Operator's Handbook and signs (decals) on machine. Follow warnings and instructions in the manuals when making repairs, adjustments or servicing. Check for correct function after adjustments, repairs or service. Untrained operators and failure to follow instructions can cause injury or death.

W-2003-0903



**Safety Alert Symbol:** This symbol with a warning statement, means: "Warning, be alert! Your safety is involved!" Carefully read the message that follows.

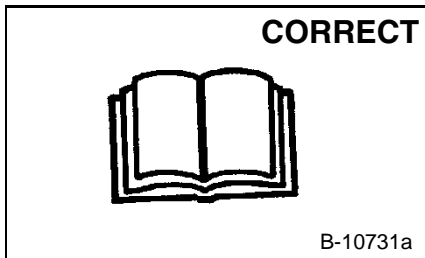

⚠ Never service the Bobcat Skid-Steer Loader without instructions.

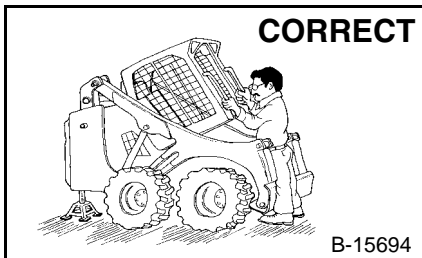

⚠ Use the correct procedure to lift or lower operator cab.

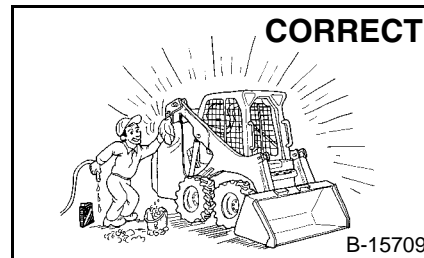

⚠ Cleaning and maintenance are required daily.

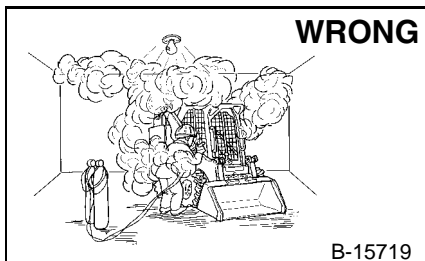

- ⚠ Have good ventilation when welding or grinding painted parts.
- ⚠ Wear dust mask when grinding painted parts. Toxic dust and gas can be produced.
- ⚠ Avoid exhaust fume leaks which can kill without warning. Exhaust system must be tightly sealed.

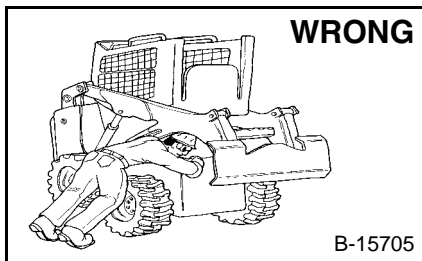

⚠ Disconnecting or loosening any hydraulic tubeline, hose, fitting, component or a part failure can cause lift arms to drop. Do not go under lift arms when raised unless supported by an approved lift arm support device. Replace if damaged.

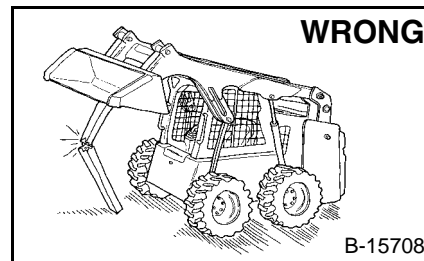

- ⚠ Never work on loader with lift arms up unless lift arms are held by an approved lift arm support device. Replace if damaged.
- ⚠ Never modify equipment or add attachments not approved by Bobcat Company.

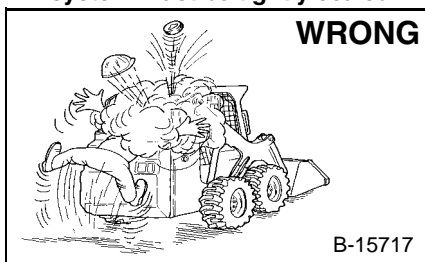

- ⚠ Stop, cool and clean engine of flammable materials before checking fluids.
- ⚠ Never service or adjust loader with the engine running unless instructed to do so in the manual.
- ⚠ Avoid contact with leaking hydraulic fluid or diesel fuel under pressure. It can penetrate the skin or eyes.
- ⚠ Never fill fuel tank with engine running, while smoking or when near open flame.

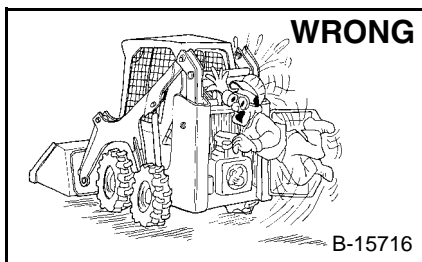

- ⚠ Keep body, jewelry and clothing away from moving parts, electrical contact, hot parts and exhaust.
- ⚠ Wear eye protection to guard from battery acid, compressed springs, fluids under pressure and flying debris when engines are running or tools are used. Use eye protection approved for type of welding.
- ⚠ Keep rear door closed except for service. Close and latch door before operating the loader.



- ⚠ Lead-acid batteries produce flammable and explosive gases.
- ⚠ Keep arcs, sparks, flames and lighted tobacco away from batteries.
- ⚠ Batteries contain acid which burns eyes or skin on contact. Wear protective clothing. If acid contacts body, flush well with water. For eye contact flush well and get immediate medical attention.

Maintenance procedures which are given in the Operation & Maintenance Manual can be performed by the owner/operator without any specific technical training. Maintenance procedures which are **not** in the Operation & Maintenance Manual must be performed **ONLY BY QUALIFIED BOBCAT SERVICE PERSONNEL**. Always use genuine Bobcat replacement parts. The Service Safety Training Course is available from your Bobcat dealer.

## ALPHABETICAL INDEX

ADVANCED CONTROL SYSTEM (ACS) .....	60-01	ELECTRICAL/HYDRAULIC CONTROLS	
ADVANCED HAND CONTROL (AHC) SYSTEM....	60-01	REFERENCE .....	60-01
ADVANCED HAND CONTROL (AHC) SYSTEM (W/PUSH BUTTON FLOAT) .....	60-01	ENGINE .....	70-01
AIR CLEANER .....	70-01	ENGINE COMPONENTS AND TESTING .....	70-01
AIR CLEANER SERVICE .....	10-01	ENGINE COOLING SYSTEM .....	10-01
AIR CONDITIONING SERVICE .....	80-01	ENGINE LUBRICATION SYSTEM .....	10-01
AIR CONDITIONING SYSTEM FLOW .....	80-01	ENGINE SPECIFICATIONS .....	SPEC-01
ALTERNATOR (55 AMP) .....	60-01	ENGINE SPEED CONTROL .....	70-01
ALTERNATOR (90 AMP) .....	60-01	EVAPORATOR .....	80-01
AUXILIARY PRESSURE RELEASE (ACCUMULATOR) .....	20-01	EVAPORATOR/HEATER UNIT.....	80-01
		EXPANSION VALVE .....	80-01
BASIC TROUBLESHOOTING .....	80-01	FAN GEARBOX .....	10-01
BATTERY .....	60-01	FINAL DRIVE TRANSMISSION (CHAINCASE .....	10-01
BICS™ SYSTEM .....	60-01	FLYWHEEL AND HOUSING .....	70-01
BOB-TACH.....	10-01, 50-01	FUEL SYSTEM.....	10-01
BOBCAT CONTROLLER .....	60-01	FUEL TANK .....	50-01
BLOWER FAN .....	80-01		
BRAKE .....	40-01	GENERAL AIR CONDITIONING SERVICE	
BRAKE (TWO-SPEED).....	40-01	GUIDELINES.....	80-01
BUCKET POSITION VALVE (873 - S/N 514147758 & BELOW) .....	20-01		
BUCKET POSITION VALVE (873 - S/N 514147759 & ABOVE & 883) .....	20-01	HEATER COIL .....	80-01
		HEATER VALVE .....	80-01
CHAINCASE .....	40-01	HYDRAULIC CONNECTION SPECS. ....	SPEC-01
CHARGE PRESSURE .....	30-30	HYDRAULIC CONTROL VALVE (FOOT CONTROL).....	20-01
COMPONENTS .....	80-01	HYDRAULIC CONTROL VALVE (ADVANCED CONTROL SYSTEM) (ACS) (AHC) ..	20-01
COMPRESSOR .....	80-01	HYDRAULIC FLUID RESERVOIR .....	20-01
CONDENSER .....	80-01	HYDRAULIC PUMP (ALUMINUM).....	20-01
CONTROL HANDLE .....	50-01	HYDRAULIC PUMP (ALUMINUM HIGH FLOW).....	20-01
CONTROL HANDLE (ADVANCED CONTROL SYSTEM (ACS) ADVANCED CONTROL HANDLE .....	50-01	HYDRAULIC PUMP (CAST IRON) .....	20-01
CONTROL HANDLE (ADVANCED CONTROL SYSTEM (ACS) SELECTABLE HAND/FOOT CONTROL.....	50-01	HYDRAULIC PUMP (CAST IRON HIGH FLOW) ....	20-01
CONTROL HANDLE (ADVANCED HAND CONTROL (AHC) .....	50-01	HYDRAULIC SYSTEM INFORMATION .....	20-01
CONTROL HANDLE (ADVANCED HAND CONTROL (AHC) (W/PUSH BUTTON FLOAT) .....	50-01	HYDRAULIC/HYDROSTATIC FILTER .....	20-01
CONTROL PANEL .....	50-01	HYDRAULIC/HYDROSTATIC FLUID SPECIFICATIONS .....	SPEC-01
CONTROL PEDALS .....	50-01	HYDRAULIC/HYDROSTATIC SYSTEM.....	10-01
CONTROL PEDALS (ACS) .....	50-01	HYDROSTATIC MOTOR .....	30-01
COOLING FAN .....	70-01	HYDROSTATIC MOTOR (TWO SPEED) .....	30-01
CONVERSIONS .....	SPEC-01	HYDROSTATIC MOTOR CARRIER.....	30-01
CYLINDER (LIFT) .....	20-01	HYDROSTATIC PUMP .....	30-01
CYLINDER (POWER BOB-TACH).....	20-01	HYDROSTATIC SYSTEM INFORMATION.....	30-01
CYLINDER (TILT) .....	20-01		
		INSTRUMENT PANEL.....	60-01
DIAGNOSTICS .....	60-01		
DRIVE COMPONENTS .....	40-01		
DRIVE BELT .....	30-01		

**<https://www.ebooklibonline.com>**

Hello dear friend!

Thank you very much for reading.

Enter the link into your browser.

The full manual is available for immediate download.

**<https://www.ebooklibonline.com>**

LIFT ARM BY-PASS CONTROL VALVE .....	20-01
LIFT ARM SUPPORT DEVICE .....	10-01
LIFT ARMS .....	50-01
LIFTING AND BLOCKING THE LOADER .....	10-01
LIGHTS .....	60-01
LOADER SPECIFICATIONS (873) .....	SPEC-01
LOADER SPECIFICATIONS (883) .....	SPEC-01
LOADER TORQUE .....	SPEC-01
LUBRICATION OF THE BOBCAT LOADER .....	10-01
MAIN RELIEF VALVE (AHC) .....	20-01
MAIN RELIEF VALVE (FOOT CONTROL) .....	20-01
MUFFLER .....	70-01
OIL COOLER .....	30-01
OIL COOLER (SEAL TO CONNECT) (STC) .....	30-01
OPERATOR CAB .....	10-01, 50-01
OPERATOR SEAT .....	50-01
OPERATOR SEAT (SUSPENSION) .....	50-01
POWER BOB-TACH .....	10-01
POWER BOB-TACH (883) .....	50-01
POWER BOB-TACH BLOCK (6674305 ALUMINUM) .....	20-01
POWER BOB-TACH BLOCK (6676547 ALUMINUM) .....	20-01
POWER BOB-TACH BLOCK (6677646 CAST IRON) .....	20-01
POWER BOB-TACH BLOCK (6678206 CAST IRON) .....	20-01
POWER BOB-TACH BLOCK (6678554) CAST IRON) .....	20-01
PRESSURE RELIEF VALVE .....	80-01
PRESSURE SWITCH .....	80-01

RADIATOR .....	70-01
REAR AUXILIARY DIVERTER VALVE (SINGLE SHUTTLE) .....	20-01
REAR DOOR .....	50-01
REAR GRILL .....	50-01
RECEIVER/DRIER .....	80-01
RECONDITIONING THE ENGINE .....	70-01
REGULAR MAINTENANCE .....	80-01
REMOTE START .....	10-01
RPM SENSOR .....	70-01
SAFETY .....	80-01
SEAT BAR .....	50-01
SEAT BAR SENSOR .....	60-01
SELECT VALVE .....	20-01
SERVICE SCHEDULE .....	10-01
STARTER .....	60-01
SYSTEM CHARGING AND RECLAMATION .....	80-01
SYSTEM TROUBLESHOOTING CHART .....	80-01
TEMPERATURE/PRESSURE .....	80-01
THERMOSTAT .....	80-01
TIRE MAINTENANCE .....	10-01
TORQUE SPECIFICATIONS FOR BOLTS .....	SPEC-01
TOWING THE LOADER .....	10-01
TRACTION LOCK .....	60-01
TRANSPORTING THE BOBCAT LOADER .....	10-01
TROUBLESHOOTING .....	70-01

## CONTENTS

FORWORD . . . . .	II
SAFETY INSTRUCTIONS . . . . .	V
SERIAL NUMBER LOCATION . . . . .	IX
DELIVERY REPORT . . . . .	X
BOBCAT LOADER IDENTIFICATION . . . . .	XI
SAFETY & MAINTENANCE . . . . .	10-01
HYDRAULIC SYSTEM . . . . .	20-01
HYDROSTATIC SYSTEM . . . . .	30-01
DRIVE SYSTEM . . . . .	40-01
MAIN FRAME . . . . .	50-01
ELECTRICAL SYSTEM & ANALYSIS . . . . .	60-01
ENGINE SERVICE . . . . .	70-01
HEATING, VENTILATION, AIR CONDITIONING . . . . .	80-01
SPECIFICATIONS . . . . .	SPEC-01

**SAFETY &  
MAINTENANCE**

**HYDRAULIC  
SYSTEM**

**HYDROSTATIC  
SYSTEM**

**DRIVE  
SYSTEM**

**MAIN FRAME**

**ELECTRICAL  
SYSTEM &  
ANALYSIS**

**ENGINE  
SERVICE**

**HVAC**

**SPECIFICATIONS**

# FORWARD

This manual is for the Bobcat loader mechanic. It provides necessary servicing and adjustment procedures for the Bobcat loader and its component parts and systems. Refer to the Operation & Maintenance Manual for operating instructions, Starting procedure, daily checks, etc.

A general inspection of the following items must be made after the loader has had service or repair:

1. Check lift arm support device, replace if damaged. (Stored Position)

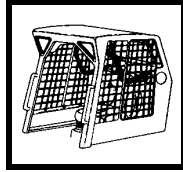

2. Check that ROPS mounting hardware is tightened and is Bobcat approved.

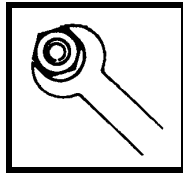

3. The seat belt must be correctly installed, functional and in good condition.

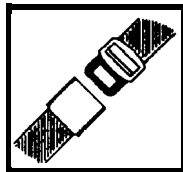

4. The seat bar must be correctly adjusted, clean and lubricated.

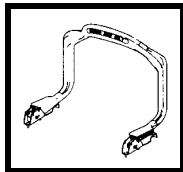

5. Check lift arm support device, replace if damaged.

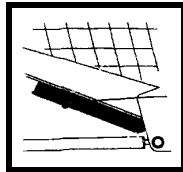

6. Machine signs must be legible and in the correct location.



7. Steering levers and foot pedals must return to neutral.

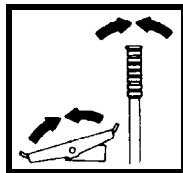

8. Check for correct function of the work lights



9. The parking brake must function correctly.



10. Enclosure door latches must open and close freely.

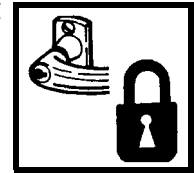

11. Bob-Tach wedges and linkages must function correctly and be in good condition.

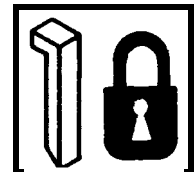

12. Safety treads must be in good condition.

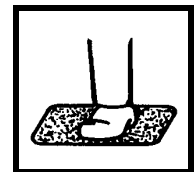

13. Check for correct function of indicator lamps (Optional on some models).

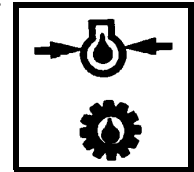

14. Check hydraulic fluid level, engine oil level and fuel supply.

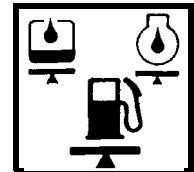

15. Inspect for fuel, oil or hydraulic fluid leaks.

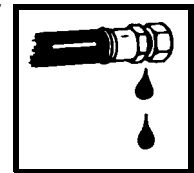

16. Lubricate the loader.

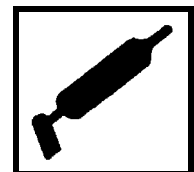

17. Check the condition of the battery and cables.

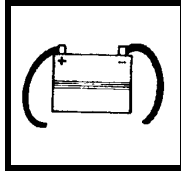

22. Operate the loader and check all functions.

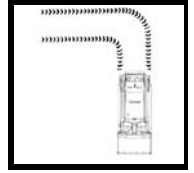

18. Inspect the air cleaner for damage or leaks. Check the condition of the element.

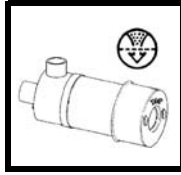

23. Check for any field modification not completed.



19. Check the electrical charging system.

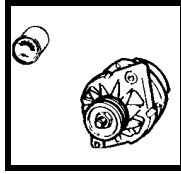

24. Check for correct function of the Bobcat Interlock Control System (BICST<sup>™</sup>) before the machine is returned to the customer.

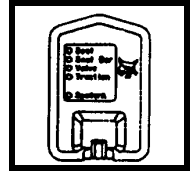

20. Check tires for wear and pressure.

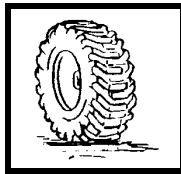

Recommend to the owner that all necessary corrections be made before the machine is returned to service.

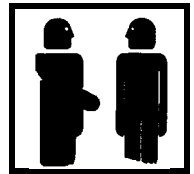

21. Inspect for loose or broken parts or connections.

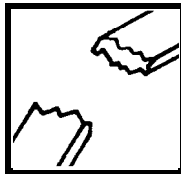

**CALIFORNIA  
PROPOSITION 65 WARNING**  
Diesel engine exhaust and some of its constituents are known to the State of California to cause cancer, birth defects and other reproductive harm.

## SAFETY INSTRUCTIONS



### Safety Alert Symbol

This symbol with a warning statement means:  
“Warning, be alert! Your safety is involved!”  
Carefully read the message that follows.



## WARNING

Instructions are necessary before operating or servicing machine. Read and understand the Operation & Maintenance Manual, Operator's Handbook and signs (decals) on machine. Follow warnings and instructions in the manuals when making repairs, adjustments or servicing. Check for correct function after adjustments, repairs or service. Untrained operators and failure to follow instructions can cause injury or death.

W-2003-0903



## WARNING

Warnings on the machine and in the manuals are for your safety. Failure to obey warnings can cause injury or death.

W-2044-1285

## IMPORTANT

This notice identifies procedures which must be followed to avoid damage to the machine.

I-2019-0284

The following publications provide information on the safe use and maintenance of the Bobcat machine and attachments:

- The Delivery Report is used to assure that complete instructions have been given to the new owner and that the machine is in safe operating condition.
- The Operation & Maintenance Manual delivered with the machine or attachment contains operating information as well as routine maintenance and service procedures. It is a part of the machine and can be stored in a container provided on the machine. Replacement Operation & Maintenance Manuals can be ordered from your Bobcat dealer.
- Machine signs (decals) instruct on the safe operation and care of your Bobcat machine or attachment. The signs and their locations are shown in the Operation & Maintenance Manual. Replacement signs are available from your Bobcat dealer.
- An Operator's Handbook fastened to the operator cab. It's brief instructions are convenient to the operator. The handbook is available from your dealer in an English edition or one of many other languages. See your Bobcat dealer for more information on translated versions.
- The AEM Safety Manual delivered with the machine gives general safety information.
- The Service Manual and Parts Manual are available from your dealer for use by mechanics to do shop-type service and repair work.
- The Skid-Steer Loader Operator Training Course is available through your local dealer or at [www.training.bobcat.com](http://www.training.bobcat.com) or [www.bobcat.com](http://www.bobcat.com). This course is intended to provide rules and practices of correct operation of the Skid-Steer Loader. The course is available in English and Spanish versions.
- Service Safety Training Courses are available from your Bobcat dealer or at [www.training.bobcat.com](http://www.training.bobcat.com) or [www.bobcat.com](http://www.bobcat.com). They provide information for safe and correct service procedures.
- The Skid-Steer Loader Safety Video is available from your Bobcat dealer or at [www.training.bobcat.com](http://www.training.bobcat.com) or [www.bobcat.com](http://www.bobcat.com).

SI SSL-0206 SM

## SAFETY INSTRUCTIONS (CONT'D)

The dealer and owner/operator review the recommended uses of the product when delivered. If the owner/operator will be using the machine for a different application(s) he or she must ask the dealer for recommendations on the new use.



# Call Before You Dig

**1-888-258-0808**

When you call, you will be directed to a location in your state/city for information about buried lines (telephone, cable TV, water, sewer, gas, etc.)

## SAFETY INSTRUCTIONS (CONT'D)

### Fire Prevention

The machine and attachments have components that are at high temperature under normal operating conditions. The primary source of high temperatures is the engine and exhaust system. The electrical system, if damaged or incorrectly maintained, can be a source of arcs or sparks.

Flammable debris (leaves, straw, etc.) must be removed regularly. If flammable debris is allowed to accumulate, it will increase fire hazard. Clean often to avoid this accumulation. Flammable debris in the engine compartment is a potential hazard.

The spark arrestor muffler is designed to control the emission of hot particles from the engine and exhaust system, but the muffler and the exhaust gases are still hot.

- Do not use the machine where exhaust, arcs, sparks or hot components can contact flammable material, explosive dust or gases.
- The operator cab, engine compartment, and engine cooling system must be inspected every day and cleaned if necessary to prevent fire hazard and overheating.
- Check all electrical wiring and connections for damage. Keep the battery terminals clean and tight. Repair or replace any damaged part.
- Check fuel and hydraulic tubes, hoses and fittings for damage and leakage. Never use open flame or bare skin to check for leaks. Tighten or replace any parts that show leakage. Always clean fluid spills. Do not use gasoline or diesel fuel for cleaning parts. Use commercial nonflammable solvents.
- Do not use ether or starting fluids on any engine which has glow plugs. These starting aids can cause explosion and injure you or bystanders.
- Always clean the machine, disconnect the battery, and disconnect the wiring from the controllers before welding. Cover rubber hoses, battery and all other flammable parts. Keep a fire extinguisher near the machine when welding. Have good ventilation when grinding or welding painted parts. Wear a dust mask when grinding painted parts. Toxic dust or gas can be produced.
- Stop the engine and let it cool before adding fuel. **NO SMOKING!**

- Use the procedure in the Operation & Maintenance Manual for connecting the battery and for jump starting.
- Use the procedure in the Operation & Maintenance Manual for cleaning the spark arrestor muffler (if equipped).

Figure 1

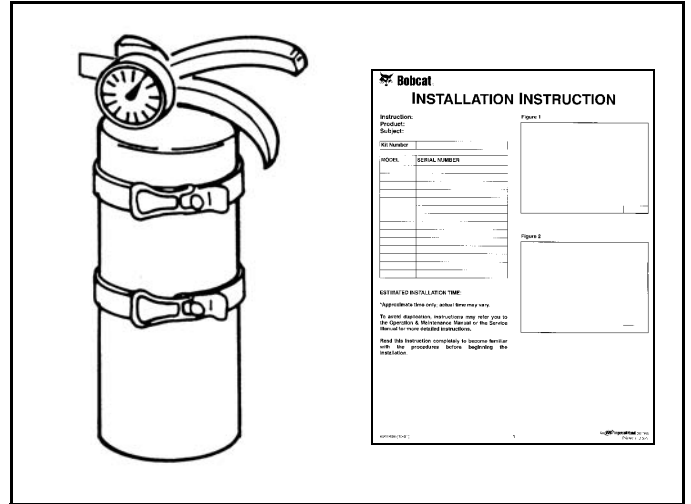

- Know where fire extinguishers and first aid kits are located and how to use them. Fire extinguishers are available from your Bobcat dealer [Figure 1].



## DELIVERY REPORT

Figure 5

The diagram shows a form layout for a delivery report. It includes a title 'DELIVERY REPORT' at the top right, a 'WARNING' section with a black header, and various sections of horizontal lines representing text input fields. A small box at the bottom right contains the identifier 'B-16315'.

The Delivery Report must be filled out by the dealer and signed by the owner or operator when the Bobcat loader is delivered. An explanation of the form must be given to the owner. Make sure it is filled out completely **[Figure 5]**.

# BOBCAT LOADER IDENTIFICATION

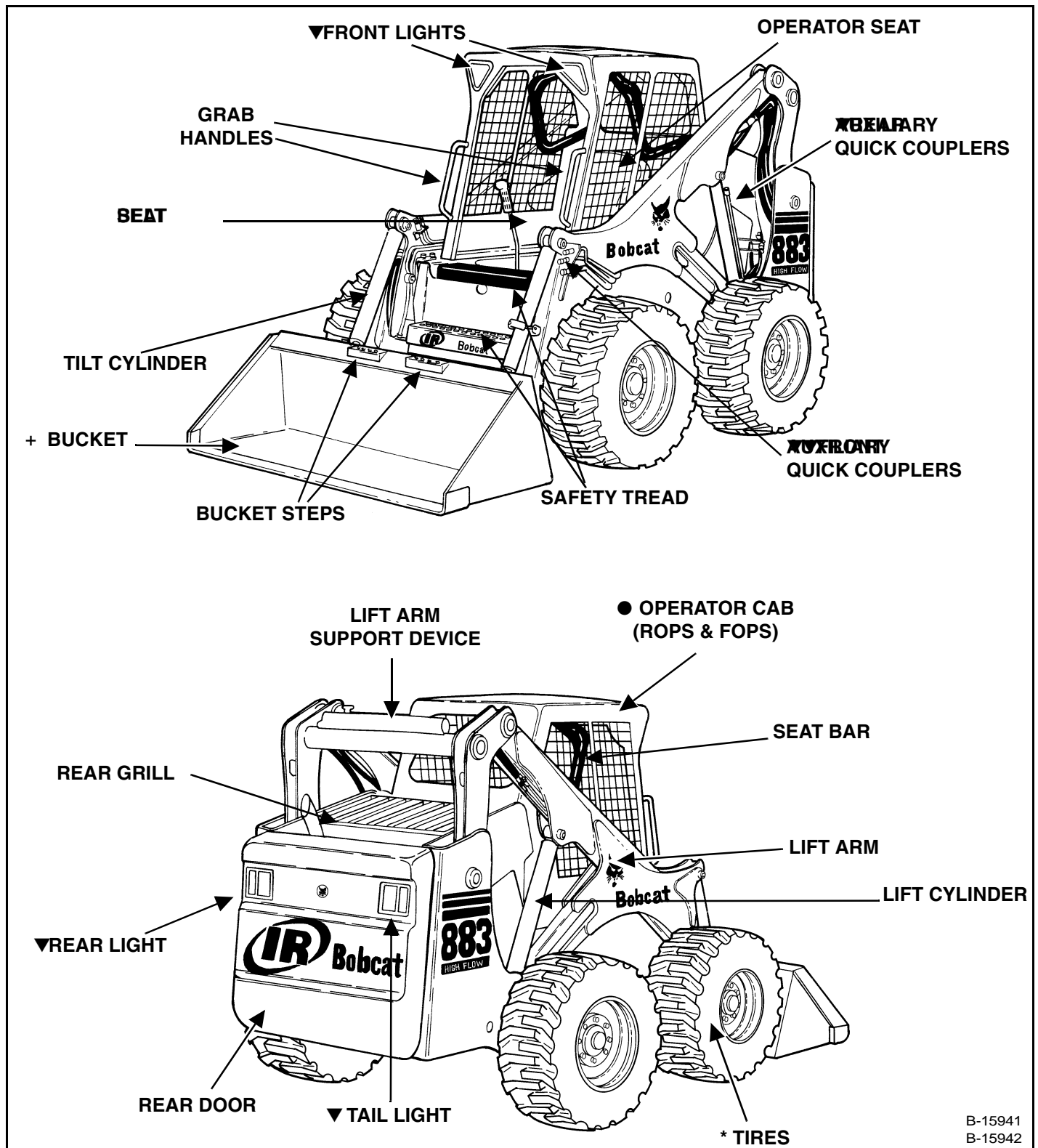

B-15941  
B-15942

- ▼ OPTIONAL OR FIELD ACCESSORY (Not Standard Equipment)
- ▼▼ STANDARD ON 883. OPTIONAL OR FIELD ACCESSORY ON 883
- \* TIRES - Flotation tires ▼ are shown. The Bobcat loader is factory equipped with standard tires.
- + BUCKET - Several different buckets and other attachments are available for the Bobcat loader.
- ROPS, FOPS - Roll Over Protective Structure, per SAE J1040 and ISO 3471, and Falling Object Protective Structure per SAEJ1043 and ISO 3449, Level I. Level II is available. The Bobcat loader is base-equipped with a standard operator cab as shown. Extra insulated cab is available as an option (Reduced noise level).

AIR CLEANER SERVICE ..... 10-80-1  
    Replacing Filter Element ..... 10-80-1

BOB-TACH ..... 10-150-1  
    Inspection And Maintenance ..... 10-150-1

ENGINE COOLING SYSTEM ..... 10-90-1  
    Cleaning The Cooling System ..... 10-90-1

ENGINE LUBRICATION SYSTEM ..... 10-110-1  
    Checking Engine Oil ..... 10-110-1  
    Replacing Oil And Filter ..... 10-110-1

FAN GEARBOX ..... 10-140-1  
    Checking And Adding Oil ..... 10-140-1

FINAL DRIVE TRANSMISSION (CHAINCASE) ..... 10-130-1  
    Checking And Adding Oil ..... 10-130-1  
    Replacing The Oil ..... 10-130-1

FUEL SYSTEM ..... 10-100-1  
    Filling The Fuel Tank ..... 10-100-1  
    Fuel Filter ..... 10-100-2  
    Fuel Lift Pump Strainer ..... 10-100-2  
    Fuel Specifications ..... 10-100-1  
    Removing Air From The Fuel System ..... 10-100-2

HYDRAULIC/HYDROSTATIC SYSTEM ..... 10-120-1  
    Checking And Adding Fluid ..... 10-120-1  
    Hydraulic/Hydrostatic Filter Replacement ..... 10-120-1  
    Replacing Hydraulic Fluid ..... 10-120-2

LIFT ARM SUPPORT DEVICE ..... 10-20-1  
    Installing The Lift Arm Support Device ..... 10-20-1  
    Removing Lift Arm Support Device ..... 10-20-2

LIFTING AND BLOCKING THE LOADER ..... 10-10-1  
    Procedure ..... 10-10-1

LUBRICATION OF THE BOBCAT LOADER ..... 10-160-1  
    Procedure ..... 10-160-1

**Continued on Next Page**

## SAFETY & MAINTENANCE (CONT'D)

OPERATOR CAB .....	10-30-1
Description .....	10-30-1
Emergency Exit .....	10-30-3
Lowering The Operator Cab .....	10-30-2
Raising The Operator Cab .....	10-30-1
POWER BOB-TACH (OPTION) .....	10-151-1
Inspection And Maintenance .....	10-151-1
REMOTE START .....	10-60-1
Procedure .....	10-60-4
Procedure for Loader With Attachments Control Harness .....	10-60-2
Procedure for Loader Without Attachments Control Harness .....	10-60-1
SERVICE SCHEDULE .....	10-70-1
Chart .....	10-70-1
TIRE MAINTENANCE .....	10-170-1
Tire Mounting .....	10-170-1
Tire Rotation .....	10-170-1
Wheel Nuts .....	10-170-1
TOWING THE LOADER .....	10-50-1
Procedure For Non-Two-Speeds .....	10-50-1
Procedure For Two-Speeds .....	10-50-2
TRANSPORTING THE BOBCAT LOADER .....	10-40-1
Procedure .....	10-40-1

## LIFTING AND BLOCKING THE LOADER

### Procedure



Instructions are necessary before operating or servicing machine. Read and understand the Operation & Maintenance Manual, Handbook and signs (decals) on machine. Follow warnings and instructions in the manuals when making repairs, adjustments or servicing. Check for correct function after adjustments, repairs or service. Untrained operators and failure to follow instructions can cause injury or death.

W-2003-0199

Figure 10-10-1



Read the Removal & Installation, Disassembly & Assembly, etc. completely to become familiar with the procedure before beginning [Figure 10-10-1].

Always park the loader on a level surface.



Put jackstands under the front axles and rear corners of the frame before running the engine for service. Failure to use jackstands can allow the machine to fall or move and cause injury or death.

W-2017-0286

Figure 10-10-2



Put floor jack under the rear of the loader [Figure 10-10-2].

Lift the rear of the loader and install jackstands [Figure 10-10-2].

Figure 10-10-3

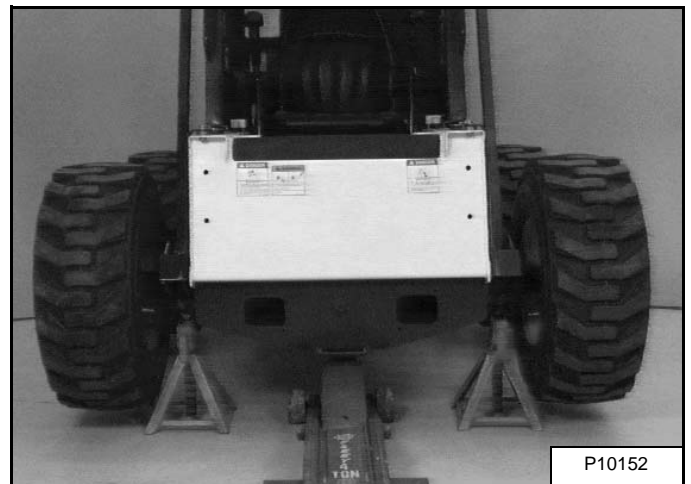

Put the floor jack under the front of the loader [Figure 10-10-3].

Lift the front of the loader and put jackstands under the axle tubes [Figure 10-10-3].

**NOTE:** Make sure the jackstands do not touch the tires.

## LIFT ARM SUPPORT DEVICE

### Installing The Lift Arm Support Device



Never work on a machine with the lift arms up unless the lift arms are secured by an approved lift arm support device. Failure to use an approved lift arm support device can allow the lift arms or attachment to fall and cause injury or death.

W-2059-0598



Service lift arm support device if damaged or if parts are missing. Using a damaged lift arm support or with missing parts can cause lift arms to drop causing injury or death.

W-2271-1197

Figure 10-20-1

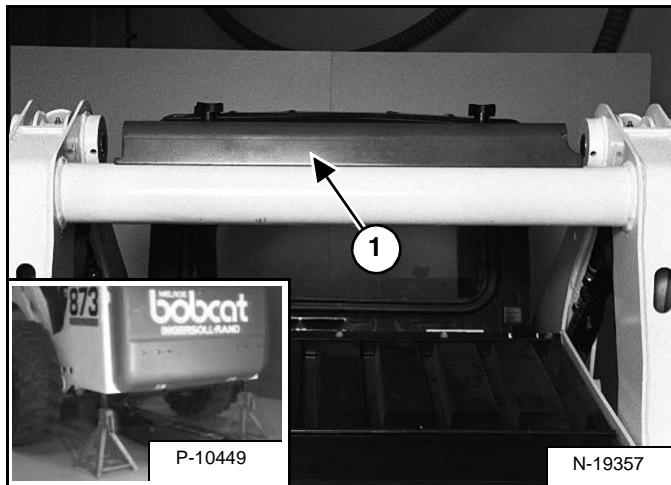

Put jackstands under the rear corners of the loader frame (Inset) [Figure 10-20-1].

Remove the lift arm support device (Item 1) [Figure 10-20-1] from the storage position.

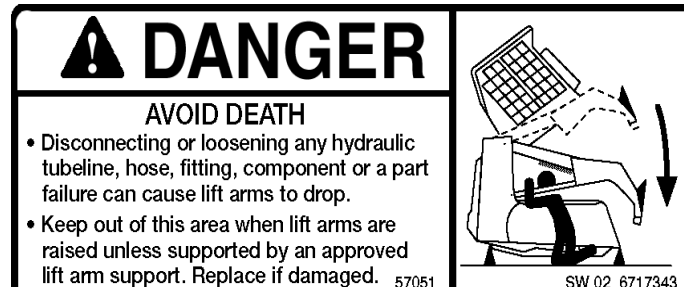
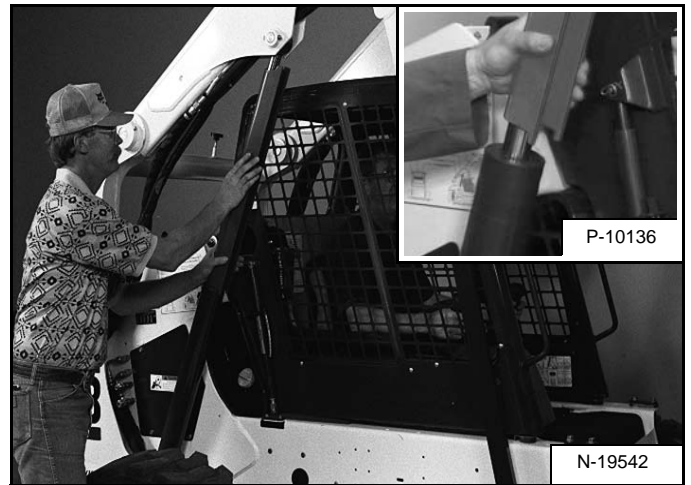

Figure 10-20-2



The operator must be in the operator's seat, with the seat belt fastened and seat bar lowered, until the lift arm support device is installed.

Start the engine, and raise the lift arms all the way up.

Have a second person install the lift arm support device over the rod of one of the lift cylinders [Figure 10-20-2].

The lift arm support device must be tight against the cylinder rod. The tabs of the lift arm support device must be under the cylinder as shown (Inset) [Figure 10-20-2].

## LIFT ARM SUPPORT DEVICE (CONT'D)

### Installing Lift Arm Support Device (Cont'd)

Figure 10-20-3



Lower the lift arms slowly until the lift arm support device is held between the lift arms and lift cylinder [Figure 10-20-3].

### Removing Lift Arm Support Device

The operator must be in the operator's seat, with the seat belt fastened and seat bar lowered, until the lift arm support device is removed and the lift arms are lowered all the way.

Start the engine, raise the lift arms all the way up.

Have a second person remove the lift arm support device.

Lower the lift arms all the way and stop the engine.

Return the lift arm support device to storage position and secure with clamping knobs.

Remove the jackstands.

## OPERATOR CAB

### Description

The Bobcat loader has an operator cab (ROPS and FOPS) as standard equipment to protect the operator from rollover and falling objects. Check with your dealer if the operator cab has been damaged. The seat belt must be worn for roll over protection.

ROPS/FOPS - Roll Over Protective Structure per SAE J1040 and ISO 3471, and Falling Object Protective Structure per SAE J1043 and ISO 3449, Level I. Level II is available.

*Level I* - Protection from falling bricks, small concrete blocks, and hand tools encountered in operations such as highway maintenance, landscaping, and other construction site services.

*Level II* - Protection from falling trees, rocks; for machines involved in site clearing, overhead demolition or forestry.

### Raising The Operator Cab



Never modify operator cab by welding, grinding, drilling holes or adding attachments unless instructed to do so by Bobcat. Changes to the cab can cause loss of operator protection from rollover and falling objects, and result in injury or death.

W-2069-1299

Always stop the engine before raising or lowering the cab.

Stop the loader on a level surface. Lower the lift arms. If the lift arms must be up while raising the operator cab, install the lift arm support device. (See Installing The Lift Arm Support Device on Page 10-20-1.)

Figure 10-30-1



Install jackstands under the rear of the loader frame [Figure 10-30-1].

Figure 10-30-2

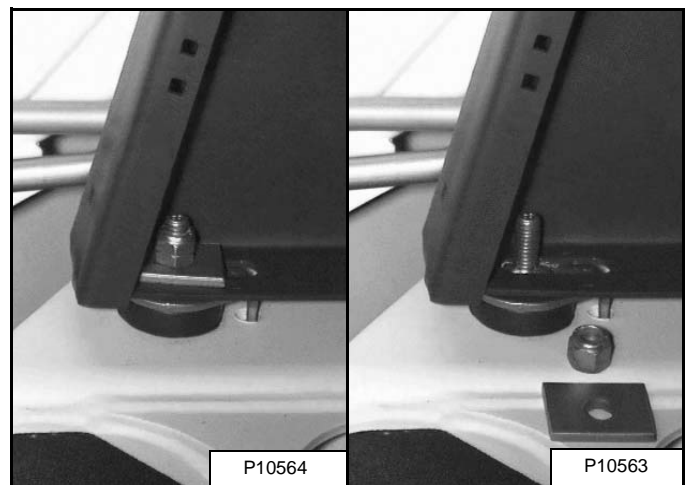

Loosen the nut (both sides) at the front corners of the operator cab [Figure 10-30-2].

Remove the nuts and plates [Figure 10-30-2] (both sides).

## OPERATOR CAB (CONT'D)

### Raising The Operator Cab (Cont'd)

Figure 10-30-3

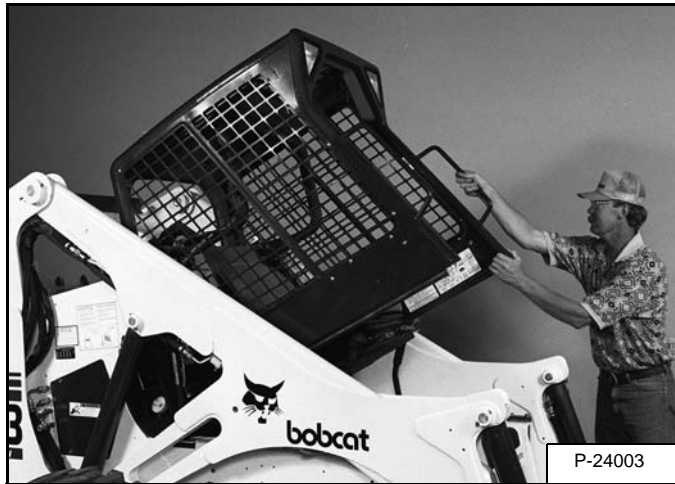

Lift on the grab handle and bottom of the operator cab slowly until the cab is all the way up and the latching mechanism engages [Figure 10-30-3].

*Advanced Hand Control Only*

### Lowering The Operator Cab

Always stop the engine before raising or lowering the cab.

**NOTE:** Make sure the seat bar is fully raised or lowered when lowering the cab. Always use the grab handles to lower the cab.

Figure 10-30-4

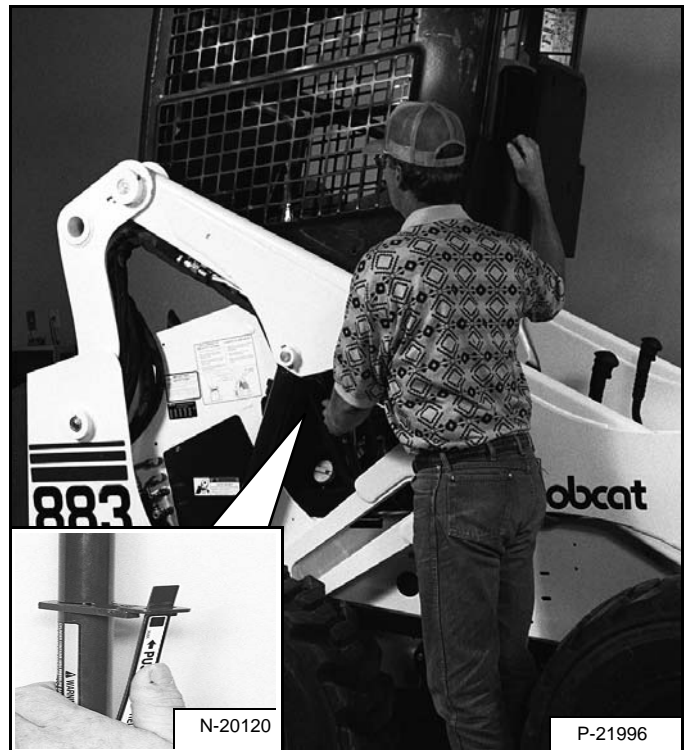

Pull down on the bottom of the operator cab until it stops at the latching mechanism [Figure 10-30-4].

Release the latching mechanism (Inset) [Figure 10-30-4] and pull the cab all the way down.

Figure 10-30-5

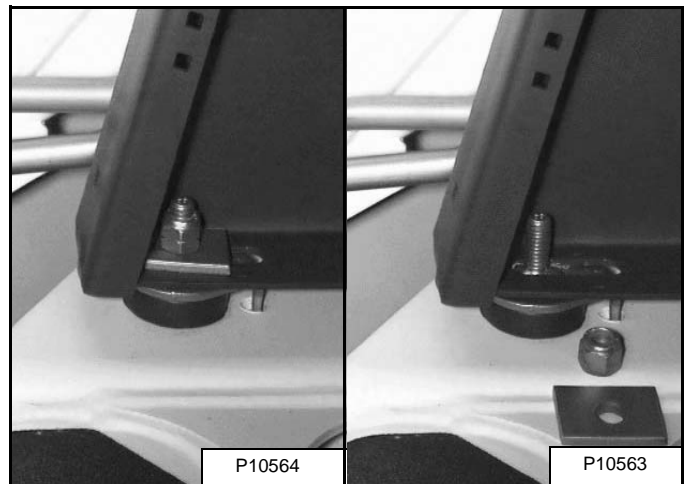

Install the plates and nuts [Figure 10-30-5] (both sides).

Tighten the nuts to 40-50 ft.-lbs. (54-68 Nm) torque.

## OPERATOR CAB (CONT'D)

### Emergency Exit

The front opening on the operator cab and rear window provide exits.

*Rear Window (If Equipped)*

Figure 10-30-6



Pull on the tag on the top of the rear window to remove the rubber cord [Figure 10-30-6].

Push the rear window out of the rear of the operator cab.

Figure 10-30-7



Exit through the rear of the operator cab [Figure 10-30-7].

*Front Door (If Equipped)*

**NOTE:** When an Operator Cab Enclosure Kit is installed, the window of the front door can be used as an emergency exit. [Figure 10-30-8]

**NOTE:** When the special applications kit is installed, the front door cannot be used for an emergency exit.

Figure 10-30-8

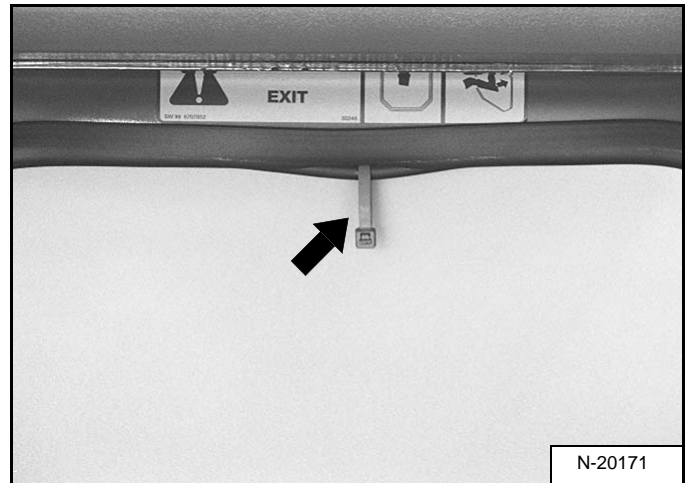

Pull the plastic loop at the top of the window in the front door to remove the rubber cord [Figure 10-30-8].

Figure 10-30-9

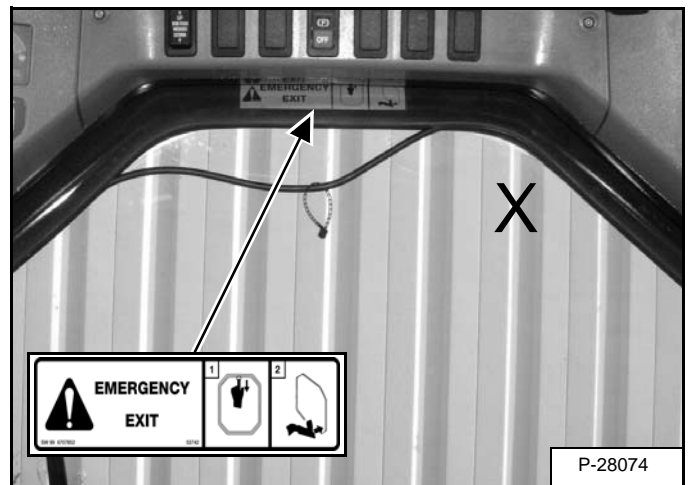

Push the window out with your foot [Figure 10-30-9] at any corner of the window.

Exit through the front door.

## TRANSPORTING THE BOBCAT LOADER

### Procedure



Adequately designed ramps of sufficient strength are needed to support the weight of the machine when loading onto a transport vehicle. Wood ramps can break and cause personal injury.

W-2058-0494

Figure 10-40-1



A loader with an empty bucket or no attachment must be loaded backward onto the transport vehicle [Figure 10-40-1].

Be sure the transport and towing vehicles are of adequate size and capacity (See Machine Dimensions on Page SPEC-11-1 for weight of loader).

The rear of the trailer must be blocked or supported [Figure 10-40-1] when loading or unloading the loader to prevent the front end of the trailer from raising up.

Figure 10-40-2

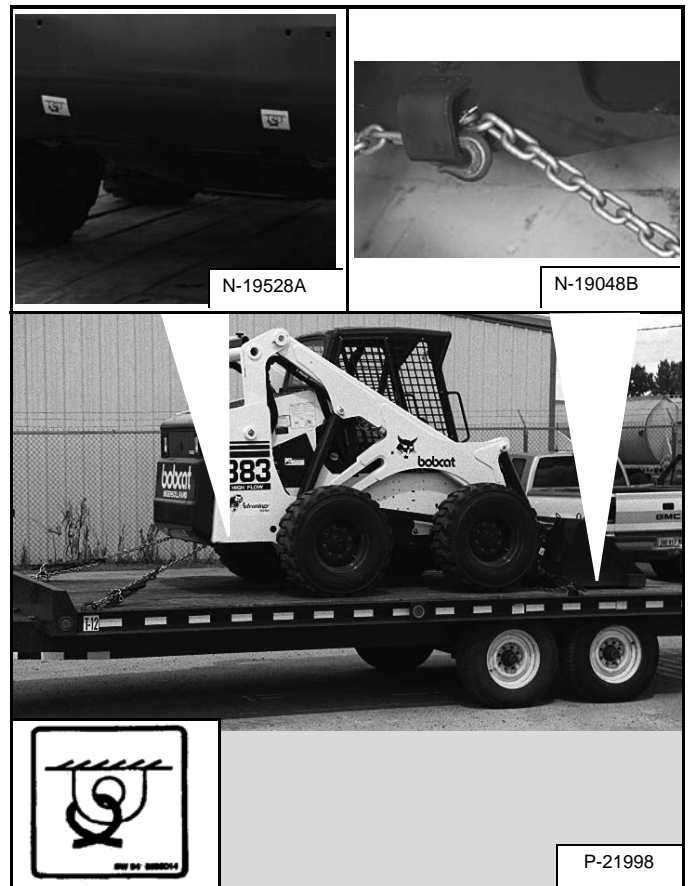

Use the following procedure to fasten the Bobcat loader to the transport vehicle to prevent the loader from moving during sudden stops or when going up or down slopes [Figure 10-40-2].

- Lower the bucket or attachment to the floor.
- Stop the engine.
- Engage the parking brake.
- Install chains at the front and rear loader tie down positions (Inset) [Figure 10-40-2].
- Fasten each end of the chain to the transport vehicle.

## TOWING THE LOADER

### Procedure For Non-Two-Speeds

# IMPORTANT

Do not push or pull the machine at more than 2 MPH (3,2 km/h) or for a distance of more than 25 feet (7,6 meters) with the towing tool in place.

I-2017-0389

To prevent damage to the loader's hydrostatic system, the loader must be towed only a short distance at slow speed. (Example: Moving the loader onto a transport vehicle).

The towing chain (or cable) must be rated at 1 & 1/2 times the weight of the loader. (See LOADER SPECIFICATIONS (873) on Page spec-10-1 or See LOADER SPECIFICATIONS (883) on Page SPEC-11-1.)

Figure 10-50-1



- Turn the key switch to RUN (Item 1) [Figure 10-50-1] (Standard Panel) OR press the RUN / ENTER Button (Deluxe).

Figure 10-50-2

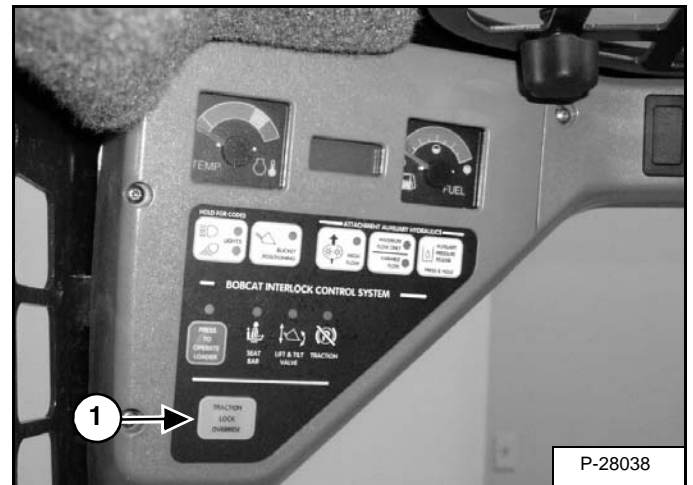

- Press the TRACTION LOCK OVERRIDE Button (Item 1) [Figure 10-50-2].
- Tow the Bobcat at 2 MPH (3,2 km/hr) or less for not more than 25 feet (7,6 meters).

If the electrical system is not functioning, contact your Bobcat loader dealer.

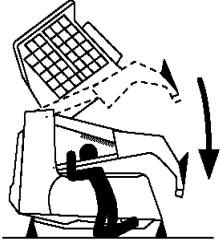
<h2> DANGER</h2> <p><b>AVOID DEATH</b></p> <ul style="list-style-type: none"><li>• Disconnecting or loosening any hydraulic tubeline, hose, fitting, component or a part failure can cause lift arms to drop.</li><li>• Keep out of this area when lift arms are raised unless supported by an approved lift arm support. Replace if damaged. 57051</li></ul>	 <p>SW 02 6717343</p>
--	---

## TOWING THE LOADER (CONT'D)

### Procedure For Two-Speeds

# ! WARNING

Never work on a machine with the lift arms up unless the lift arms are secured by an approved lift arm support device. Failure to use an approved lift arm support device can allow the lift arms or attachment to fall and cause injury or death.

W-2059-0598

Raise the operator cab. (See Raising The Operator Cab on Page 10-30-1.)

Figure 10-50-3

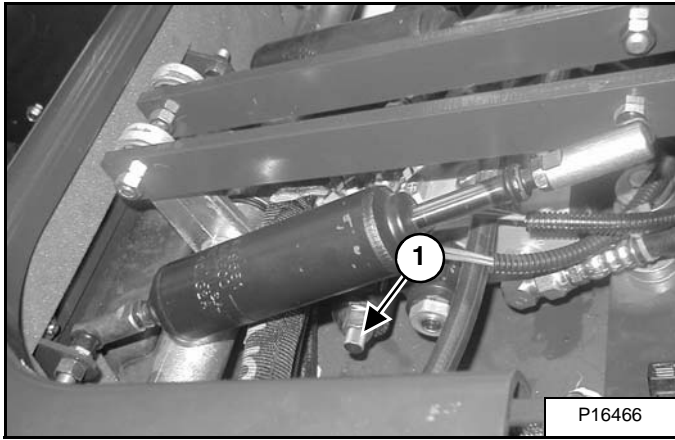

Disengage the parking brake solenoid valve by pushing **IN** on the red Traction Lock By-Pass Knob (Item 1) [Figure 10-50-3] and turning it **1/4 TURN counterclockwise**. The knob will come out to release the solenoid valve.

Figure 10-50-4

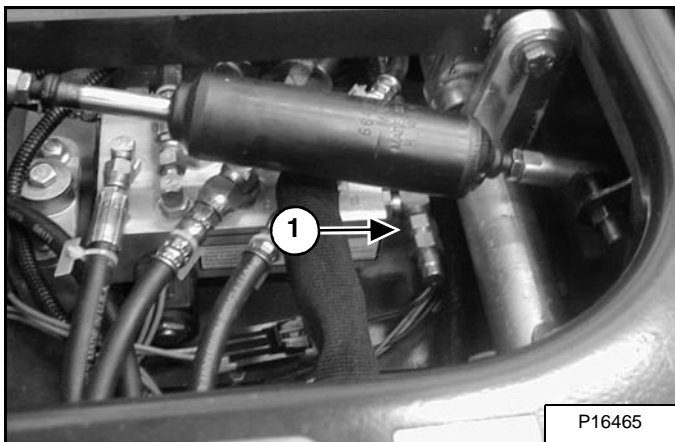

Connect a Port-a-Power to the coupler (Item 1) [Figure 10-50-4].

Figure 10-50-5

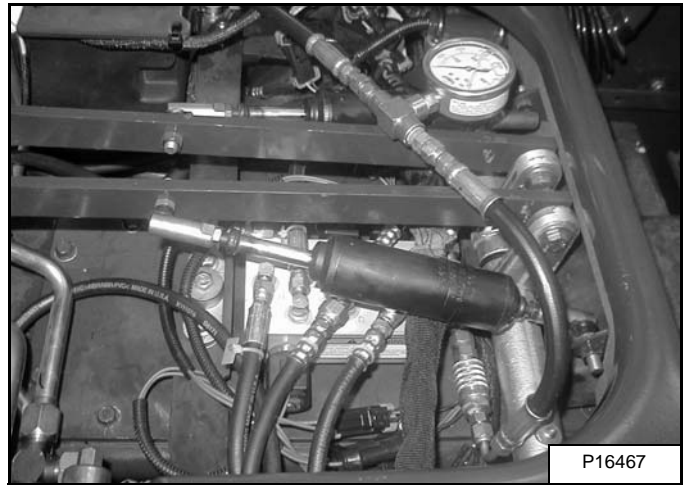

Operate the Port-a-Power 350-400 PSI (2413-2758 kPa) to release the brake [Figure 10-50-5].

Lower the operator cab and tow the loader.

Before operating the loader again, disconnect the Port-a-Power.

**Engage the parking brake solenoid valve**, by pushing **IN** on the red Traction Lock By-Pass Knob (Item 1) [Figure 10-50-3] and turning it **1/4 TURN clockwise**.

# ! WARNING

Unexpected loader movement.

Can cause serious injury or death.

Push in and turn red traction lock bypass knob clockwise to the engaged position before operating loader. Read Operation and Maintenance Manual for more instructions.

6803932



**Suggest:**

**If the above button click is invalid.**

**Please download this document**

**first, and then click the above link**

**to download the complete manual.**

**Thank you so much for reading**

## REMOTE START

### Procedure for Loader Without Attachments Control Harness

# ! WARNING

#### AVOID INJURY OR DEATH

With the 7-pin connector plugged into the loader and Remote Start Key Switch in the OFF position, the loader can still be started from the operator panel inside the cab. Placing the key switch of the remote start tool in the run position disconnects the operator panel key switch from the start circuit. If the service technician will be working the engine area it is important to remove the operator panel keys.

W-2357-0899

The tool listed will be need to do the following procedure:

MEL1563: Remote Start Tool Kit

Figure 10-60-1

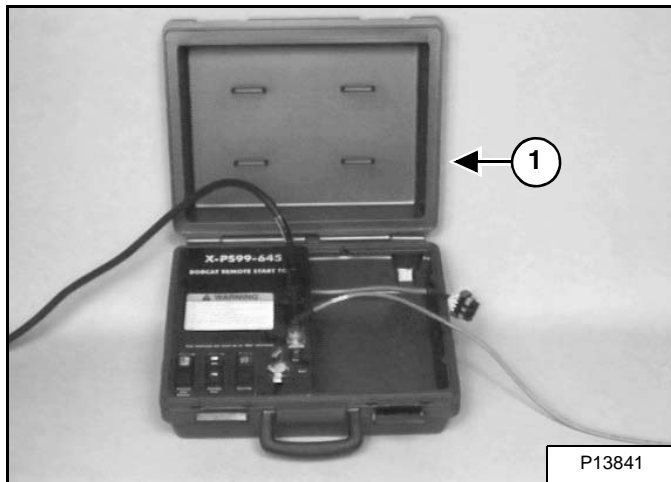

The remote start (Item 1) [Figure 10-60-1] is required when the operator cab is in the raised position for service and the service technician needs to turn the key switch on or start the engine. Example: Control Handle: linkage neutral adjustment.

Lift and block the loader. (See LIFTING AND BLOCKING THE LOADER on Page 10-10-1.)

Raise the lift arms (if required by the procedure) and install an approved lift arm support device. (See LIFT ARM SUPPORT DEVICE on Page 10-20-1.)

Raise the operator cab (if required by the procedure). (See Raising The Operator Cab on Page 10-30-1.)

Open the rear door of the loader.

Figure 10-60-2

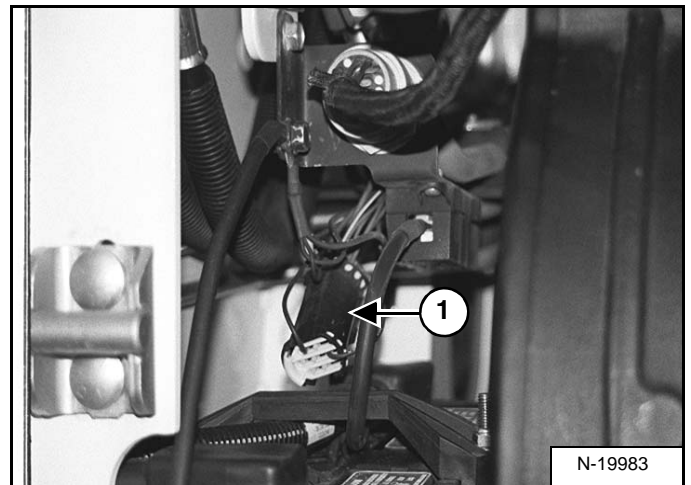
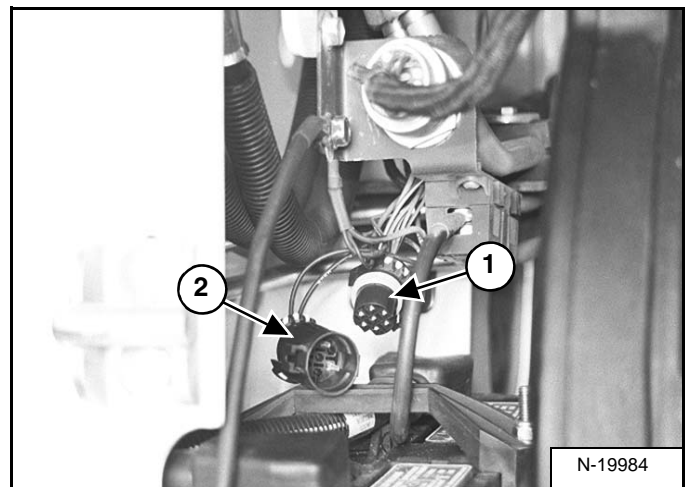

Figure 10-60-3



Remove the cap (Item 1) [Figure 10-60-2] from the loader harness (Item 1) [Figure 10-60-3].

When the remote start procedure is completed, replace the loader connector cap (Item 2) [Figure 10-60-3].

**<https://www.ebooklibonline.com>**

Hello dear friend!

Thank you very much for reading.

Enter the link into your browser.

The full manual is available for immediate download.

**<https://www.ebooklibonline.com>**