



**Bobcat®**

# Service Manual

S/N 512212001 thru 512249999  
S/N 512440001 thru 512449999  
S/N 512612001 thru 512619999

EQUIPPED WITH  
BOBCAT INTERLOCK  
CONTROL SYSTEM (BICS™)

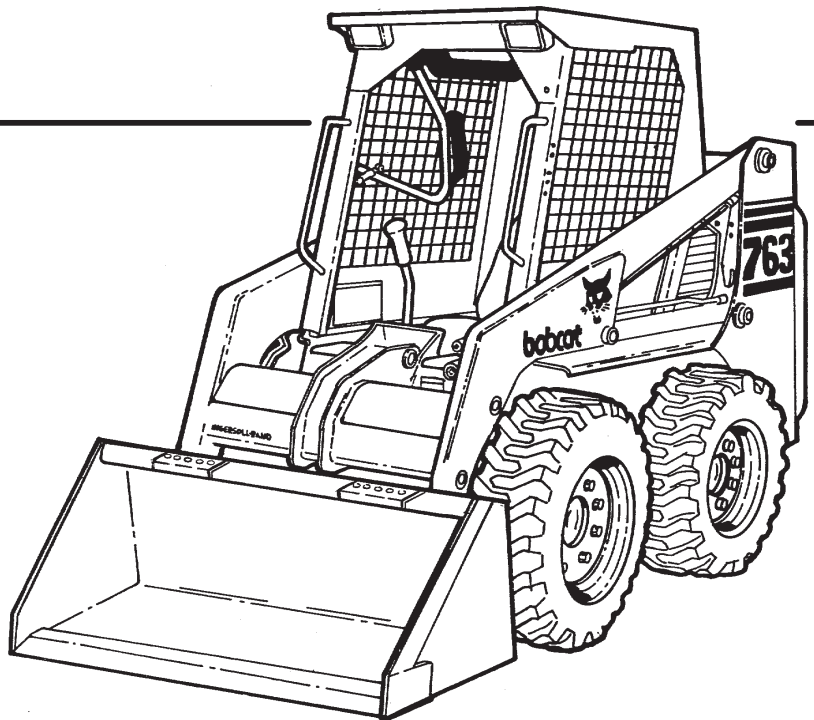

**IR Bobcat®**  
Printed in U.S.A.

# MAINTENANCE SAFETY



## WARNING

Instructions are necessary before operating or servicing machine. Read and understand the Operation & Maintenance Manual, Operator's Handbook and signs (decals) on machine. Follow warnings and instructions in the manuals when making repairs, adjustments or servicing. Check for correct function after adjustments, repairs or service. Untrained operators and failure to follow instructions can cause injury or death.

W-2003-0903



**Safety Alert Symbol:** This symbol with a warning statement, means: "Warning, be alert! Your safety is involved!" Carefully read the message that follows.

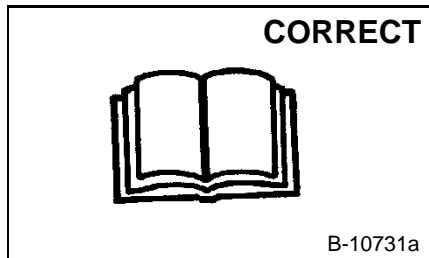

B-10731a

Never service the Bobcat Skid-Steer Loader without instructions.

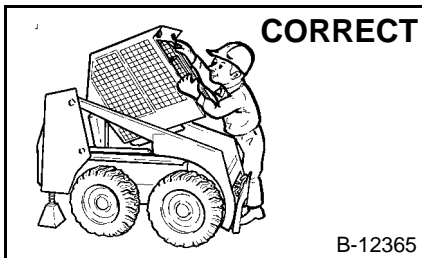

B-12365

Use the correct procedure to lift or lower operator cab.

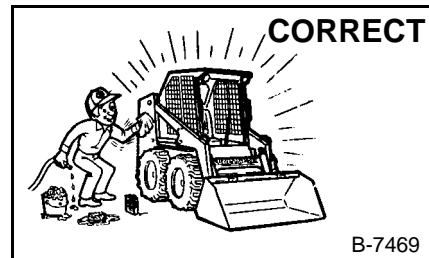

B-7469

Cleaning and maintenance are required daily.

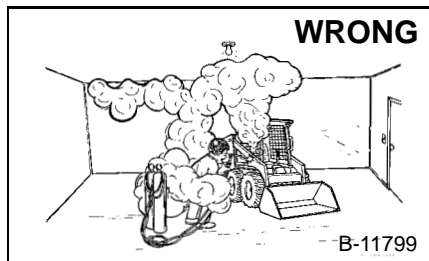

B-11799

- Have good ventilation when welding or grinding painted parts.
- Wear dust mask when grinding painted parts. Toxic dust and gas can be produced.
- Avoid exhaust fume leaks which can kill without warning. Exhaust system must be tightly sealed.

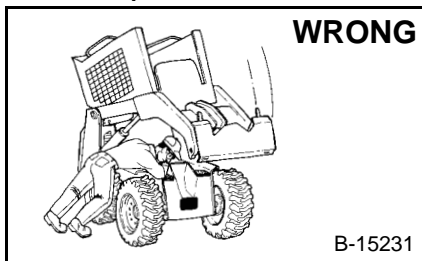

B-15231

Disconnecting or loosening any hydraulic tubeline, hose, fitting, component or a part failure can cause lift arms to drop. Do not go under lift arms when raised unless supported by an approved lift arm support device. Replace it if damaged.

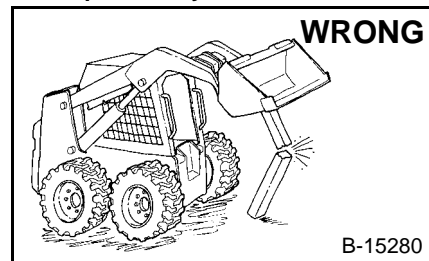

B-15280

- Never work on loader with lift arms up unless lift arms are held by an approved lift arm support device. Replace if damaged.
- Never modify equipment or add attachments not approved by Bobcat Company.

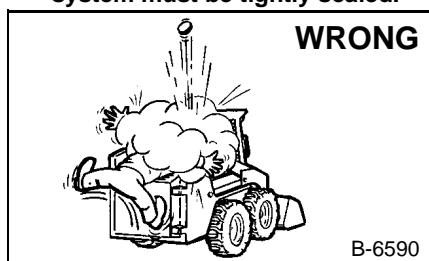

B-6590

- Stop, cool and clean engine of flammable materials before checking fluids.
- Never service or adjust loader with the engine running unless instructed to do so in the manual.
- Avoid contact with leaking hydraulic fluid or diesel fuel under pressure. It can penetrate the skin or eyes.
- Never fill fuel tank with engine running, while smoking or when near open flame.

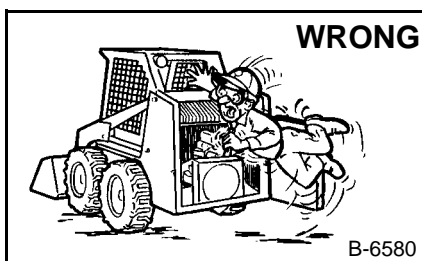

B-6580

- Keep body, jewelry and clothing away from moving parts, electrical contact, hot parts and exhaust.
- Wear eye protection to guard from battery acid, compressed springs, fluids under pressure and flying debris when engines are running or tools are used. Use eye protection approved for type of welding.
- Keep rear door closed except for service. Close and latch door before operating the loader.

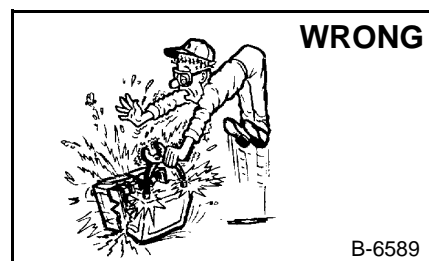

B-6589

- Lead-acid batteries produce flammable and explosive gases.
- Keep arcs, sparks, flames and lighted tobacco away from batteries.
- Batteries contain acid which burns eyes or skin on contact. Wear protective clothing. If acid contacts body, flush well with water. For eye contact flush well and get immediate medical attention.

Maintenance procedures which are given in the Operation & Maintenance Manual can be performed by the owner/operator without any specific technical training. Maintenance procedures which are **not** in the Operation & Maintenance Manual must be performed **ONLY BY QUALIFIED BOBCAT SERVICE PERSONNEL**. Always use genuine Bobcat replacement parts. The Service Safety Training Course is available from your Bobcat dealer.

## ALPHABETICAL INDEX

ACTUATORS .....	10-1	LIFT ARM SUPPORT DEVICE .....	1-1
ACTUATOR VOLTAGE TEST .....	10-1	LIFT ARMS .....	5-1
A.H.C. COMPONENTS .....	10-1	LIFT CYLINDER(S) .....	2-1
A.H.C./PWM CONTROLLER .....	10-1	LIFT LOCK BY-PASS VALVE .....	2-1
A.H.C. HANDLE .....	10-1	LIFTING AND BLOCKING THE LOADER .....	1-1
A.H.C. STEERING LEVER .....	10-1	LIFTING THE LOADER .....	1-1
AIR CLEANER .....	7-1	LOADER SPECIFICATIONS - 763 .....	9-1
AIR CLEANER SERVICE .....	1-1	LUBRICATING THE LOADER .....	1-1
ALTERNATOR .....	6-1	MONITOR SERVICE CODES .....	8-1
ALTERNATOR BELT .....	1-1	MOTOR CARRIER .....	4-1
AXLE SEAL .....	4-1	OIL COOLER .....	3-1
AXLE, SPROCKET AND BEARINGS .....	4-1	OIL PUMP .....	7-1
BATTERY .....	6-1	OPERATOR CAB .....	1-1, 5-1
BICS™ SYSTEM CONTROLLER .....	8-1	OPERATOR CAB GAS CYLINDER .....	5-1
BICS VALVE .....	2-1	OPERATOR SEAT .....	5-1
BLOWER HOUSING/FAN GEARBOX .....	7-1	PARKING BRAKE .....	4-1
BOBCAT INTERLOCK .....		PARKING BRAKE DISC .....	4-1
CONTROL SYSTEM (BICS™) .....	8-1, 10-1	PEDAL INTERLOCK LINKAGE .....	2-1
BOB-TACH .....	1-1, 5-1	PISTON AND CONNECTING ROD .....	7-1
BOSS® DIAGNOSTIC TOOL .....	8-1	RADIATOR .....	7-1
BOSS® INSTRUMENT PANEL .....	8-1	REAR DOOR .....	5-1
CHAINCASE COVERS .....	4-1	REAR GRILL .....	5-1
CHAINCASE FLUID .....	4-1	REAR LIGHTS .....	5-1
CONTROL PANEL .....	3-1	RELAY SWITCHES .....	6-1
CONTROL PEDALS .....	2-1	REMOTE START SWITCH .....	1-1
CRANKSHAFT AND BEARINGS .....	7-1	ROCKER ARM AND SHAFT .....	7-1
CRANKSHAFT GEAR .....	7-1	RPM SENSOR .....	8-1
CYLINDER BORE .....	7-1	SEAT BAR (W/COMPRESSION SPRINGS) .....	5-1
CYLINDER HEAD .....	7-1	SEAT BAR (W/GAS CYLINDER) .....	5-1
DECIMAL & MILLIMETER EQUIVALENTS .....	9-1	SEAT BAR RESTRAINT SYSTEM .....	1-1
DRIVE BELT .....	1-1	SEAT BAR SENSOR .....	8-1
DRIVE BELT HOUSING .....	3-1	SEAT SENSOR .....	8-1
DRIVE CHAIN .....	4-1	SELECT VALVE (763H) .....	2-1
ELECTRICAL/HYDRAULIC (CONTROL REF.) .....	8-1	SENDER AND SENSOR .....	8-1
ELECTRICAL SYSTEM INFORMATION .....	6-1	SERVICE SCHEDULE .....	1-1
ENGINE .....	7-1	SPARK ARRESTOR MUFFLER .....	1-1
ENGINE COMPRESSION .....	7-1	SPRING LOADED DRIVE BELT TENSIONER .....	
ENGINE COOLING SYSTEM .....	1-1	PULLEY .....	3-1
ENGINE LUBRICATION SYSTEM .....	1-1	STANDARD INSTRUMENT PANEL .....	6-1
ENGINE MUFFLER .....	7-1	STANDARD TORQUE SPECIFICATIONS .....	
ENGINE SPECIFICATIONS .....	9-1	FOR BOLTS .....	9-1
ENGINE SPEED CONTROL .....	7-1	STARTER (DELCO REMY) .....	6-1
FAN GEARBOX .....	1-1, 7-1	STARTER (DENSO) .....	6-1
FINAL DRIVE TRANSMISSION (CHAINCASE) .....	1-1	STEERING LINKAGE .....	3-1
FIXED DRIVE BELT TENSIONER PULLEY .....	3-1	SWITCH HANDLE .....	10-1
FLYWHEEL .....	7-1	STOPPING THE BOBCAT LOADER .....	1-1
FRONT LIGHTS .....	6-1	TILT LOCK VALVE .....	2-1
FUEL CAMSHAFT .....	7-1	TILT CYLINDER .....	2-1
FUEL INJECTION NOZZLES .....	7-1	TIMING GEARS .....	7-1
FUEL INJECTION PUMP .....	7-1	TIMING GEARCASE COVER .....	7-1
FUEL SYSTEM .....	1-1	TIRE MAINTENANCE .....	1-1
FUEL TANK .....	5-1	TORQUE SPECIFICATIONS FOR LOADER .....	9-1
GLOW PLUGS .....	7-1	TOWING THE LOADER .....	1-1
HANDLE CONTROL UNIT .....	10-1	TRACTION LOCK .....	8-1
HYDRAULIC CONTROL VALVE .....	2-1	TRACTION LOCK GUIDES .....	4-1
HYDRAULIC CONTROL VALVE (AHC) .....	10-1	TRANSPORTING THE LOADER .....	1-1
HYDRAULIC CYLINDER IDENTIFICATION .....	2-1	TROUBLESHOOTING .....	2-1, 3-1, 6-1, 7-1, 10-1
HYDRAULIC CYLINDERS .....	2-1	TROUBLESHOOTING .....	
HYDRAULIC FILTER HOUSING .....	2-1	THE BOSS® & L.C.D. DISPLAY .....	8-1
HYDRAULIC FLUID RESERVOIR .....	2-1	U.S. TO METRIC CONVERSION .....	9-1
HYDRAULIC/HYDROSTATIC .....		VALVE, VALVE SEAT AND GUIDE .....	7-1
FLUID SPECIFICATIONS .....	9-1	WATER PUMP .....	7-1
HYDRAULIC/HYDROSTATIC SYSTEM .....	1-1		
HYDRAULIC PUMP .....	2-1		
HYDRAULIC SYSTEM INFORMATION .....	9-1		
HYDROSTATIC DRIVE MOTOR .....	3-1		
HYDROSTATIC DRIVE MOTOR 30 SERIES .....	3-1		
HYDROSTATIC PUMP .....	3-1		
HYDROSTATIC SYSTEM INFORMATION .....	3-1		
IDLER GEAR AND CAMSHAFT .....	7-1		

**<https://www.ebooklibonline.com>**

Hello dear friend!

Thank you very much for reading.

Enter the link into your browser.

The full manual is available for immediate download.

**<https://www.ebooklibonline.com>**

# CONTENTS

FOREWORD .....	ii
SAFETY INSTRUCTIONS .....	v
SERIAL NUMBER LOCATIONS .....	vii
DELIVERY REPORT .....	vii
BOBCAT LOADER IDENTIFICATION .....	viii
PREVENTIVE MAINTENANCE .....	1-1
HYDRAULIC SYSTEM .....	2-1
HYDROSTATIC SYSTEM .....	3-1
DRIVE SYSTEM .....	4-1
MAIN FRAME .....	5-1
ELECTRICAL SYSTEM .....	6-1
ENGINE SERVICE .....	7-1
SYSTEMS ANALYSIS .....	8-1
SPECIFICATIONS .....	9-1
ADVANCED HAND CONTROL SYSTEM .....	10-1

**CALIFORNIA  
PROPOSITION 65 WARNING**  
Diesel engine exhaust and some of its  
constituents are known to the State of California  
to cause cancer, birth defects and other  
reproductive harm.

**PREVENTIVE  
MAINTENANCE**

**HYDRAULIC  
SYSTEM**

**HYDROSTATIC  
SYSTEM**

**DRIVE  
SYSTEM**

**MAIN  
FRAME**

**ELECTRICAL  
SYSTEM**

**ENGINE  
SERVICE**

**SYSTEMS  
ANALYSIS**











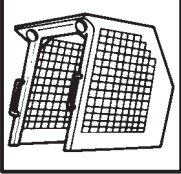

**SPECIFICATIONS**

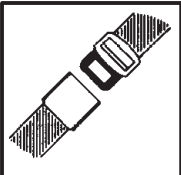
**ADVANCED  
HAND CONTROL  
SYSTEM**

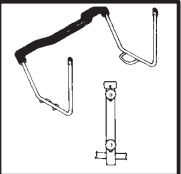
# FOREWORD

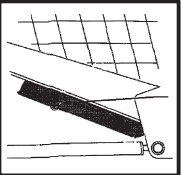
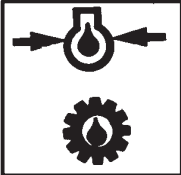
This manual is for the Bobcat loader mechanic. It provides necessary servicing and adjustment procedures for the Bobcat loader and its component parts and systems. Refer to the Operation & Maintenance Manual for operating instructions, starting procedure, daily checks, etc.

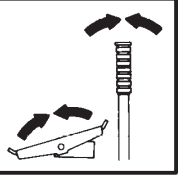
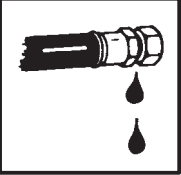
A general inspection of the following items must be made after the loader has had service or repair:

- |   |   |  |   |
|---|---|--|---|
| 1. Check that the ROPS/FOPS (Including sidescreens) is in good condition and is not modified. |    | 9. The parking brake must function correctly.                                      |    |
| 2. Check that ROPS mounting hardware is tightened and is Melroe approved.                     |    | 10. Enclosure door latches must open and close freely.                             |    |
| 3. The seat belt must be correctly installed, functional and in good condition.               |    | 11. Bob-Tach wedges and linkages must function correctly and be in good condition. |    |
| 4. The seat bar and pedal interlocks must be correctly adjusted, clean and lubricated.        |   | 12. Safety treads must in good condition.  |   |
| 5. Check lift arm support device, replace if damaged.   |  | 13. Check for correct function of indicator lamps (Optional on some models).       |  |
| 6. Machine signs must be legible and in the correct location.                                 |  | 14. Check hydraulic fluid level, engine oil level and fuel supply.                 |  |
| 7. Steering levers and foot pedals must return to neutral.                                    |  | 15. Inspect for fuel, oil or hydraulic fluid leaks.                                |  |
| 8. Check for correct function of the work lights.   |  | 16. Lubricate the loader.  |  |

17. Check the condition of the battery and cables.

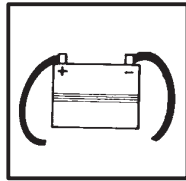

18. Inspect the air cleaner for damage or leaks. Check the condition of the element.

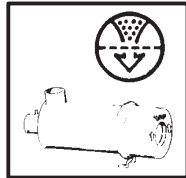

19. Check the electrical charging system.

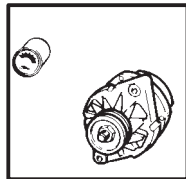

20. Check tires for wear and pressure.

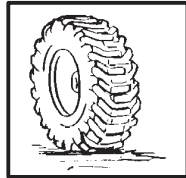

21. Inspect for loose or broken parts or connections.

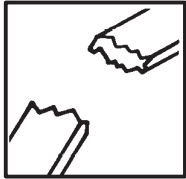

22. Operate the loader and check all functions.

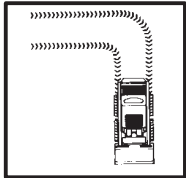

23. Check for any field modification not completed.



24. Check for correct function of the Bobcat Interlock Control System (BICS™) before the machine is returned to the customer.

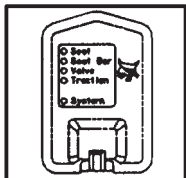

Recommend to the owner that all necessary corrections be made before the machine is returned to service.

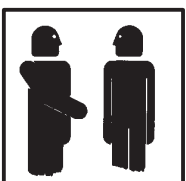

## SAFETY INSTRUCTIONS

# **WARNING**

Instructions are necessary before operating or servicing machine. Read and understand the Operation & Maintenance Manual, Handbook and signs (decals) on machine. Follow warnings and instructions in the manuals when making repairs, adjustments or servicing. Check for correct function after adjustments, repairs or service. Untrained operators and failure to follow instructions can cause injury or death.

W-2003-0199

The following publications provide information on the safe use and maintenance of the loader and attachments:

- The Delivery Report is used to assure that complete instructions have been given to the new owner and that the machine is in safe operating condition.
- The Operation & Maintenance Manual delivered with the loader gives operating information as well as routine maintenance and service procedures. It is a part of the loader and must stay with the machine when it is sold. Replacement Operation & Maintenance Manuals can be ordered from your Bobcat loader dealer.
- The loader has machine signs (decals) which instruct on the safe operation and care. The signs and their locations are shown in the Operation & Maintenance Manual. Replacement signs are available from your Bobcat loader dealer.
- The loader has a plastic Operator's Handbook fastened to the operator cab. Its brief instructions are convenient to the operator. The Handbook is available from your dealer in an English edition or one of many other languages. See your Bobcat dealer for more information on translated versions.
- The EMI Safety Manual (available in Spanish) delivered with the loader gives general safety information.
- The Service Manual and Parts Manual are available from your dealer for use by mechanics to do shop-type service and repair work.
- The Skid-Steer Loader Operator Training Course is available through your local dealer. This course is intended to provide rules and practices for correct operation of the Bobcat loader. The course is available in English and Spanish version.
- The Service Safety Training Course is available from your Bobcat dealer. This course provides information for safe and correct service procedures for Bobcat Skid-Steer loaders.
- The Bobcat Skid-Steer Loader Safety Video is available from your Bobcat Dealer.

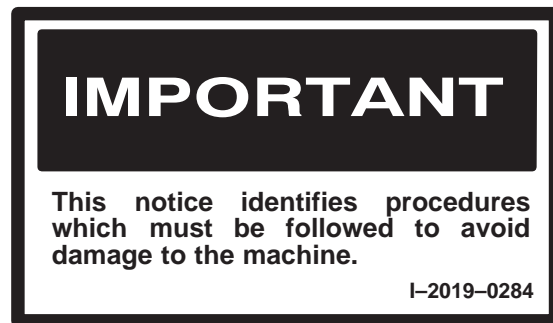

**Safety Alert Symbol:** This symbol with a warning statement, means: "Warning, be alert! Your safety is involved!" Carefully read the message that follows.

## FIRE PREVENTION

The loader has several components that are at high temperature under normal operating conditions. The primary source of high temperatures is the engine and exhaust system. The electrical system, if damaged or incorrectly maintained, can be a source of arcs or sparks.

Flammable debris (leaves, straw, etc.) must be removed regularly. If flammable debris is allowed to accumulate, it will increase the fire hazard. The loader must be cleaned as often as necessary to avoid this accumulation. Flammable debris in the engine compartment is a fire hazard when the loader is parked with a hot engine.

The spark arrestor muffler is designed to control the emission of hot particles from the engine and exhaust system, but the muffler and the exhaust gases are still hot.

- Do not use the Bobcat loader where exhaust, arcs, sparks or hot components can contact flammable material, explosive dust or gases.
- The engine compartment and engine cooling system must be inspected every day and cleaned if necessary to prevent fire hazard and overheating.
- Check all electrical wiring and connections for damage. Keep the battery terminals clean and tight. Repair or replace any damaged part.
- Check fuel and hydraulic tubes, hoses and fittings for damage and leakage. Never use open flame or bare skin to check for leaks. Tighten or replace any parts that show leakage. Always clean fluid spills. Do not use gasoline or diesel fuel for cleaning parts. Use commercial nonflammable solvents.
- Do not use ether or starting fluids on this engine. It has glow plugs. These starting aids can cause explosion and injure you or bystanders.
- Always clean the loader and disconnect the battery before doing any welding. Cover rubber hoses, battery and all other flammable parts. Keep a fire extinguisher near the loader when welding. Have good ventilation when grinding or welding painted parts. Wear dust mask when grinding painted parts. Toxic dust or gas can be produced.
- Stop the engine and let it cool before adding fuel. No smoking!
- Use the procedure in the Operation & Maintenance Manual for connecting the battery.
- Use the procedure in the Operation & Maintenance Manual for cleaning the spark arrestor muffler.
- Know where fire extinguishers and first aid kits are located and how to use them.

A fire extinguisher is available from your Bobcat dealer. The fire extinguisher can be installed in the location shown [A].



SI06-0301

## SERIAL NUMBER LOCATIONS

Always use the serial number of the loader when requesting service information or when ordering parts. Early or later models (identification made by serial number) may use different parts, or it may be necessary to use a different procedure in doing a specific service operation.

### LOADER SERIAL NUMBER

The loader serial number plate is located on the loader frame as shown [A].

Explanation of loader Serial Number:

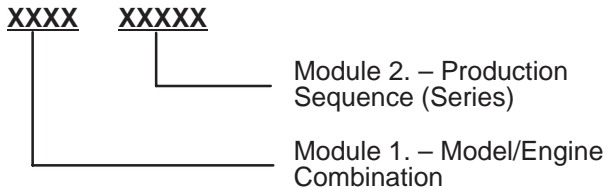

The four digit Model/Engine Combination module number identifies the model number and engine combination.

The five digit Production Sequence Number identifies the order which the loader is produced.

### ENGINE SERIAL NUMBER

The serial number is located on the valve cover at the the right side of the engine [B].

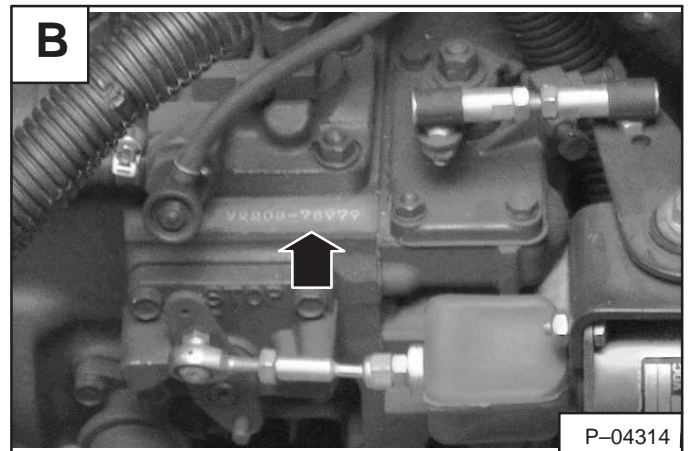

### DELIVERY REPORT

The Delivery Report must be filled out by the dealer and signed by the owner or operator when the Bobcat loader is delivered. An explanation of the form must be given to the owner. Make sure it is filled out completely [C].

C

DELIVERY REPORT

WARNING

## BOBCAT LOADER IDENTIFICATION

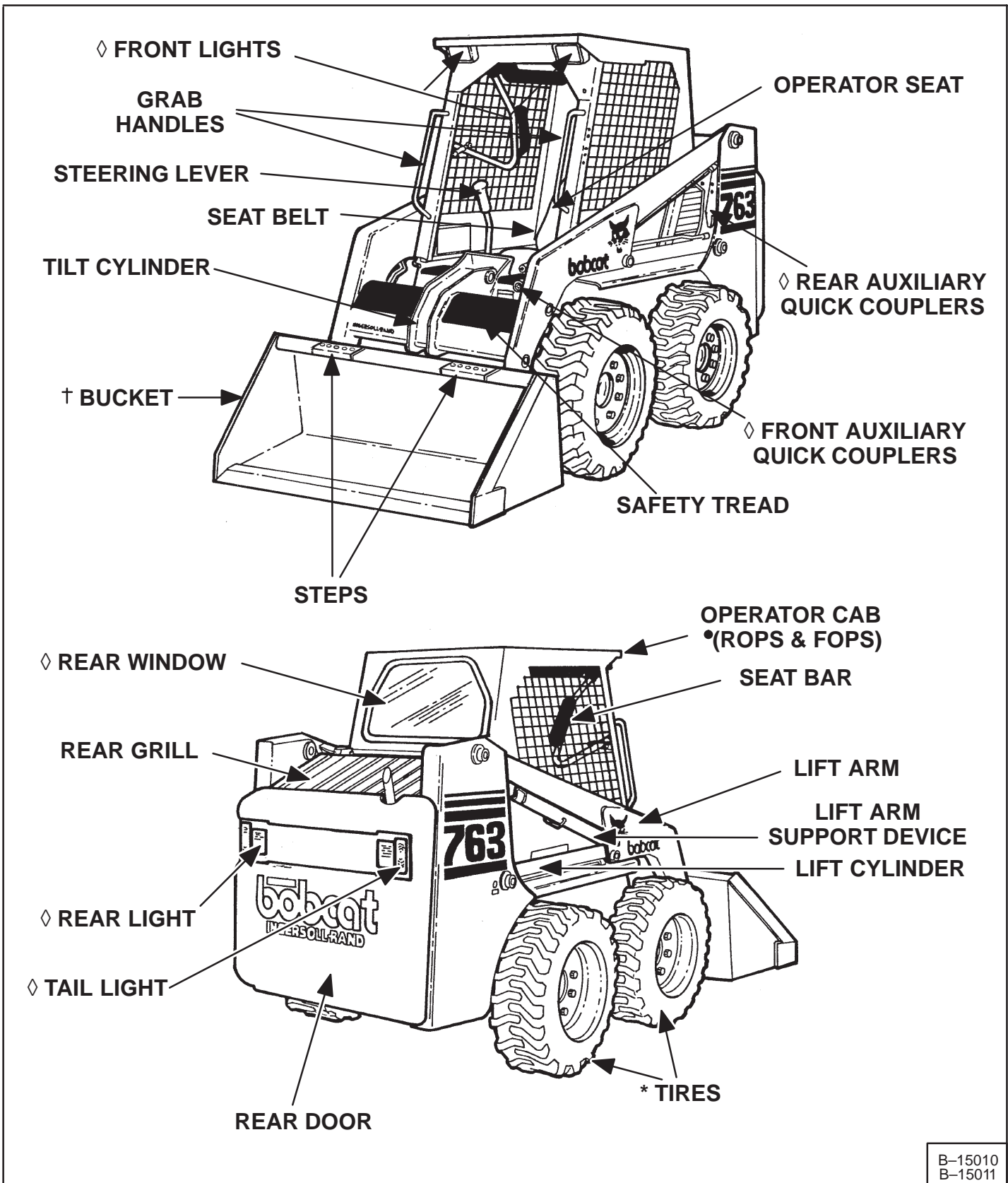

◇ OPTIONAL OR FIELD ACCESSORY (Not Standard Equipment)

\* TIRES – Flotation tires (optional) are shown. The Bobcat loader is factory equipped with standard tires.

† BUCKET – Several different buckets and other attachments are available for the Bobcat loader.

● ROPS, FOPS – Roll Over Protective Structure, Falling Object Protective Structure, per SAE J1040 and ISO 3471, and Falling Object Protective Structure per SAE J1043 and ISO 3449, Level I. Level II is available. The Bobcat loader is base-equipped with a standard operator cab as shown. Extra insulated cab is available as an option (Reduced noise level).

B-15010  
B-15011

# PREVENTIVE MAINTENANCE

## PREVENTIVE MAINTENANCE

	Page Number
AIR CLEANER SERVICE	
Replacing Filter Element .....	1-15
ALTERNATOR BELT	
Adjusting The Alternator Belt .....	1-23
BOB-TACH	
Inspection And Maintenance .....	1-36
DRIVE BELT	
Adjusting The Drive Belt Equipped With The Fixed Drive Idler .....	1-32
Adjusting The Drive Belt Equipped With The Spring Loaded Drive Idler .....	1-30
Drive Belt Replacement .....	1-33
ENGINE COOLING SYSTEM	
Cleaning The Cooling System .....	1-21
Checking The Coolant Level .....	1-21
Replacing The Coolant .....	1-22
ENGINE LUBRICATION SYSTEM	
Checking Engine Oil .....	1-19
Replacing Oil And Filter .....	1-19
FAN GEARBOX	
Checking And Maintaining .....	1-23
FINAL DRIVE TRANSMISSION (CHAINCASE)	
Checking And Adding Oil .....	1-29
Removing Oil From The Chaincase .....	1-29
FUEL SYSTEM	
Filling the Fuel Tank .....	1-17
Fuel Filter .....	1-17
Fuel Specifications .....	1-17
Removing Air From The Fuel System .....	1-18
HYDRAULIC/HYDROSTATIC SYSTEM	
Checking And Adding Fluid .....	1-24
Replacing Hydraulic/Hydrostatic Filter .....	1-24
Hydraulic Reservoir Breather Cap .....	1-26
Replacing Hydraulic Fluid .....	1-25
LIFT ARM SUPPORT DEVICE	
Disengaging The Lift Arm Support Device .....	1-8
Engaging The Lift Arm Support Device .....	1-7

Continued On Next Page

## PREVENTIVE MAINTENANCE (Cont'd)

	<b>Page Number</b>
LIFTING AND BLOCKING THE LOADER	
Procedure .....	1-4
LIFTING THE LOADER	
Single Point Lift .....	1-6
LUBRICATION OF THE LOADER	
Procedure .....	1-34
OPERATOR CAB	
Description .....	1-9
Lowering The Operator Cab .....	1-11
Raising The Operator Cab .....	1-9
Emergency Exit .....	1-9
REMOTE START SWITCH	
Procedure .....	1-37
SEAT BAR RESTRAINT SYSTEM (ADVANCED HAND CONTROLS)	
Description .....	1-14
Seat Bar Inspection .....	1-14
Seat Bar Maintenance .....	1-14
SEAT BAR RESTRAINT SYSTEM (MECHANICAL HAND CONTROLS)	
Description .....	1-13
Seat Bar Inspection .....	1-13
Seat Bar Maintenance .....	1-13
SEAT BAR RESTRAINT SYSTEM (FOOT PEDALS)	
Description .....	1-12
Seat Bar Inspection .....	1-12
Seat Bar Maintenance .....	1-12
SERVICE SCHEDULE	
Chart .....	1-3
SPARK ARRESTOR MUFFLER	
Cleaning Procedure .....	1-27
STOPPING THE BOBCAT LOADER .....	1-5
TIRE MAINTENANCE	
Tire Mounting .....	1-28
Tire Rotation .....	1-28
Wheel Nuts .....	1-28
TOWING THE LOADER	
Procedure .....	1-5
TRANSPORTING THE LOADER	
Procedure .....	1-5

## SERVICE SCHEDULE

Maintenance work must be done at regular intervals. Failure to do so will result in excessive wear and early failures. The service schedule is a guide for correct maintenance of the Bobcat loader.

# WARNING

Instructions are necessary before operating or servicing machine. Read and understand the Operation & Maintenance Manual, Handbook and signs (decals) on machine. Follow warnings and instructions in the manuals when making repairs, adjustments or servicing. Check for correct function after adjustments, repairs or service. Untrained operators and failure to follow instructions can cause injury or death.

W-2003-0199

SERVICE SCHEDULE		HOURS					
ITEM	SERVICE REQUIRED	8-10	50	100	250	500	1000
Engine Oil	Check the oil level and add oil as needed.						
Engine Air Filter and Air System	Check condition indicator or display panel. Service only when required. Check for leaks and damaged components.						
Engine Cooling System	Clean debris from oil cooler, radiator and grill. Check coolant level in recovery tank (engine cold). Add coolant as needed.						
Tires	Check for damaged tires and correct air pressure.						
Seat Belt, Seat Bar, Foot Pedal or Hand Control Interlocks	Check the condition of seat belt. Check the seat bar, and foot pedal interlocks or hand control interlocks. Clean dirt and debris from moving parts.						
Safety Signs and Safety Tread	Check for damaged signs (decals) and safety tread. Replace any signs or safety treads that are damaged or worn.						
Indicators & Lights (Opt.)	Check for correct operation of all indicators & lights.						
Operator Cab	Check the fastening bolts, washers & nuts. Check the condition of cab.						
Lift Arms, Cyl., Bob-Tach Pivot Pins and Wedges	Lubricate with multi-purpose lithium based grease.						
Fuel Filter	Remove the trapped water.						
Bobcat Interlock Control System (BICS™)	Check BICS™ functions. Clean dirt, debris or objects from under and behind seat and around brake pedal as required.						
Hydraulic Fluid, Hoses and Tubelines	Check fluid level and add as needed. Check for damage and leaks. Repair or replace as needed.						
Final Drive Trans.(Chaincase)	Check oil level.						
Foot Pedals, Hand Controls, and Steering Levers	Check for correct operation. Repair or adjust as needed.						
Wheel Nuts	<input type="checkbox"/> Check for loose wheel nuts and tighten to 105–115 ft.-lbs. (142–156 Nm) torque.						
Parking Brake	Check operation.						
Spark Arrestor Muffler	Clean the spark chamber.						
Battery	Check cables, connections and electrolyte level. Add distilled water as needed						
Steering Shaft	Grease two fittings.						
Engine/Hydros. Drive Belt	* Check for wear or damage. Adjust as needed.						
Fan Drive Gearbox	Check gear lube level. Add as needed.						
Alternator Belt	Check belt tension and adjust as needed.						
Engine Oil and Filter	† Replace oil and filter. Use CD or better grade oil and Bobcat filter.						
Fuel Filter	Replace the filter element.						
Hydraulic Reservoir Breather Cap	Replace the reservoir breather cap.						
Hydraulic Reservoir	Replace the fluid.						
Final Drive Trans.(Chaincase)	Replace the fluid.						
Hydraulic/Hydrostatic Filter	● Replace the filter element.						
Case Drain Filters	Replace the filters.						
Bobcat Interlock Control System (BICS™)	Check lift arm bypass control						

- Check wheel nut torque every 8 hours for the first 24 hours.
- Replace filter element after the first 50 hours and when the transmission warning light comes ON.
- Or every 12 months.
- \* Inspect the new belt after first 50 hours.
- † First oil and filter change must occur at 50 hours; 250 hours thereafter.



## WARNING

Instructions are necessary before operating or servicing machine. Read and understand the Operation & Maintenance Manual, Handbook and signs (decals) on machine. Follow warnings and instructions in the manuals when making repairs, adjustments or servicing. Check for correct function after adjustments, repairs or service. Untrained operators and failure to follow instructions can cause injury or death [A].

W-2003-0199

### LIFTING AND BLOCKING THE LOADER

#### Procedure

Always park the loader on a level surface.



## WARNING

Put jackstands under the front axles and rear corners of the frame before running the engine for service. Failure to use jackstands can allow the machine to fall or move and cause injury or death.

W-2017-0286

Put the floor jack under the rear of the loader [B].

Lift the rear of the loader and install jackstands [B].

Put the floor jack under the front the loader [C].

Lift the front of the loader and put jackstands under the axle tubes [C].

**NOTE:** Make sure the jackstands do not touch the tires.

A



B-07023

B



P-03869

C

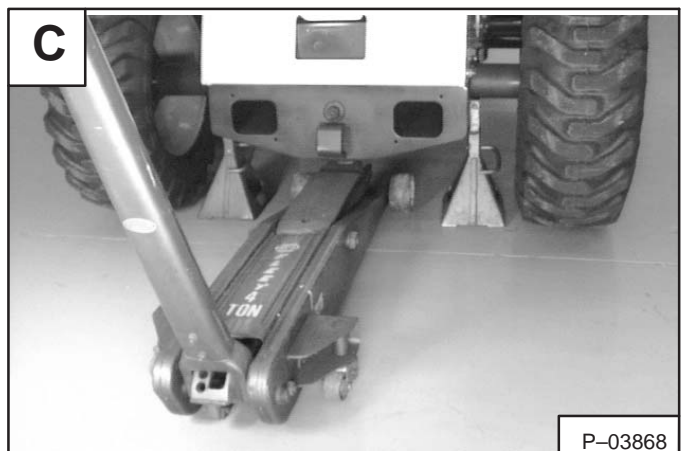

P-03868

## TRANSPORTING THE BOBCAT LOADER

### **WARNING**

Adequately designed ramps of sufficient strength are needed to support the weight of the machine when loading onto a transport vehicle. Wood ramps can break and cause personal injury.

W-2058-0494

When a loader has an empty bucket or no attachment, always drive backward onto the transport vehicle [A].

The rear of the trailer must be blocked or supported [A] when loading or unloading the loader to prevent the front end of the trailer from raising up.

Be sure the transport and towing vehicles are of adequate size and capacity.

Use the following procedure to fasten the Bobcat loader to the transport vehicle to prevent the loader from moving during sudden stops or when going up or down slopes [B].

- Lower the bucket or attachment to the floor.
- Stop the engine.
- Engage the parking brake.
- Install chains at the front and rear loader tie down positions (Inset) [B].
- Fasten each end of the chain to the transport vehicle.

## TOWING THE LOADER

To prevent damage to the loader's hydrostatic system, tow the loader only a short distance at slow speed. (Example: Moving the loader onto a transport vehicle).

The towing chain (or cable) must be rated at 1 & 1/2 times the weight of the loader. (See *SPECIFICATIONS* Page 9-1.)

- Turn the key switch to ON and press the traction lock override button.
- Tow the Bobcat at 2 MPH (3,2 km/hr) or less for not more than 25 feet (7,6 meters).

If the electrical system is not functioning, contact your Bobcat loader dealer. (Part of the brake system must be disassembled to move the loader.)

## STOPPING THE BOBCAT LOADER

Move the steering levers to the neutral position.

The hydrostatic transmission will act as a *service brake* to stop the loader.

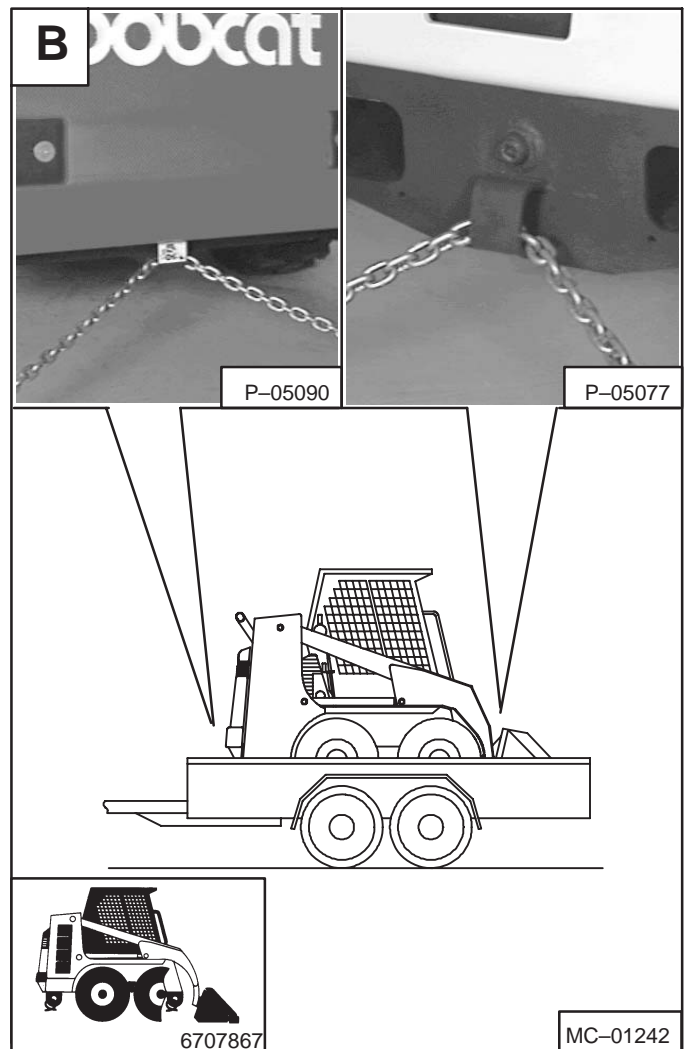
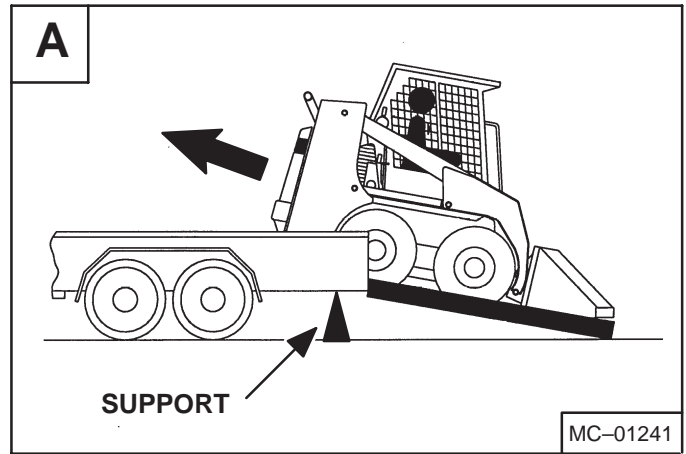

## LIFTING THE LOADER

### Single Point Lift

! **WARNING**

**AVOID INJURY OR DEATH**

- Before lifting, check fasteners on single point lift and operator cab.
- Assemble front cab fasteners as shown in this manual.
- Never allow riders in the cab or bystanders within 15 feet (5 meters) while lifting the machine.

W-2007-0497

Lift the loader with the single point lift which is available as a kit from your Bobcat loader dealer.

Attach cables or chains to the single point lift as shown [A].

The single point lift, supplied by Bobcat Company is designed to lift and support the Bobcat loader without affecting roll over and falling object protection features of the operator cab.

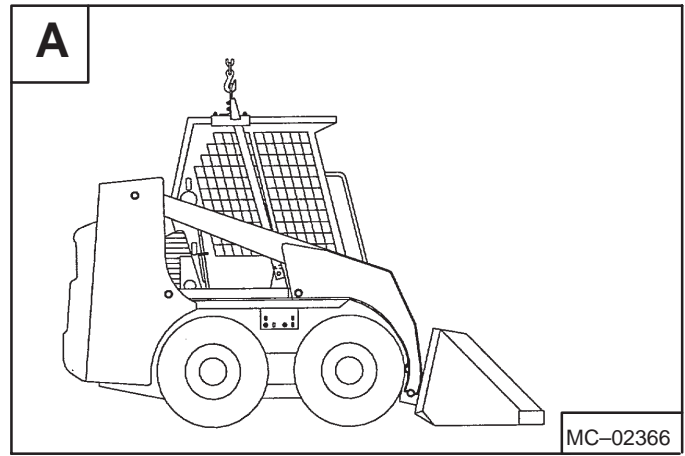

## LIFT ARM SUPPORT DEVICE

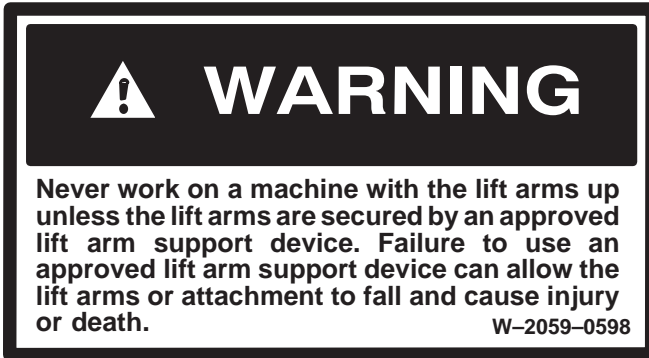
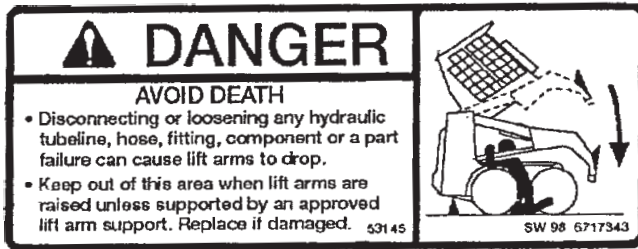

### Engaging The Lift Arm Support Device

Maintenance and service work can be done with the lift arms lowered. If the lift arms must be raised for service, use the following procedure:

Put jackstands under the rear corners of the loader.

Disconnect the spring from the lift arm support device retaining pin (Item 1) [A], hold onto the lift arm support device (Item 2) [A] and remove the retaining pin.

Lower the lift arm support device on top of the lift cylinder. Hook the free end of the spring (Item 1) [B] to the lift arm support device so there will be no interference with the support device engagement.

With the operator in the seat, seat belt fastened and seat bar lowered, start the engine.

Raise the lift arms, until the lift arm support device drops onto the lift cylinder rod [C].

Lower the lift arms slowly until the support device is held between the lift arm and the lift cylinder. Stop the engine. Raise the seat bar and move foot pedals (or hand controls) until both lock.

Install pin (Item 1) [C] into the rear of the lift arm support device below the cylinder rod.

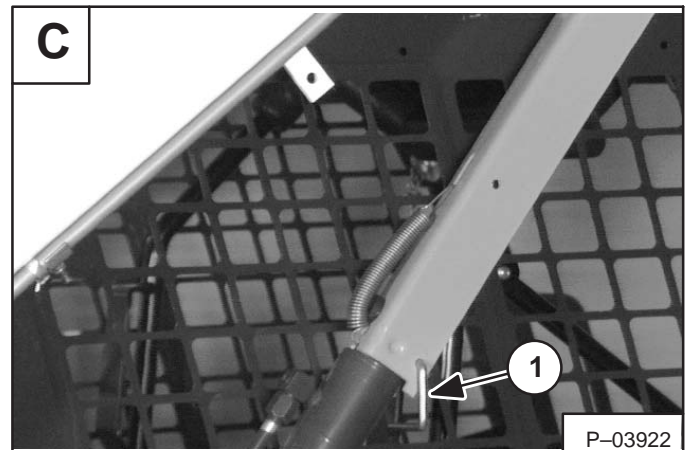
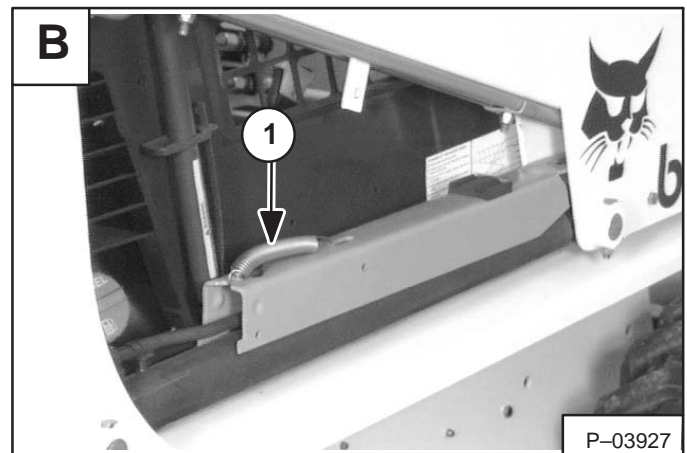
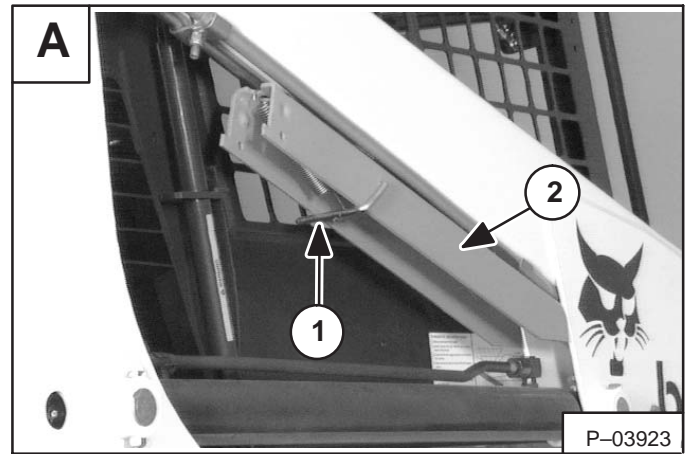

## LIFT ARM SUPPORT DEVICE (Cont'd)

### Disengaging The Lift Arm Support Device

Remove the pin from the lift arm support device.

Connect the spring (Item 1) **[A]** from the lift arm support device to the bracket below the lift arms.

With the operator in the seat, seat belt fastened and seat bar lowered, start the engine.

Raise the lift arms a small amount and the spring will lift the support device off the lift cylinder rod.

Lower the lift arms and stop the engine.

Raise the seat bar and move pedals (or hand controls) until both lock.

Disconnect the spring from the bracket.

Raise the support device into storage position and insert pin (Item 1) **[B]** through lift arm support device and bracket. Connect spring to pin.

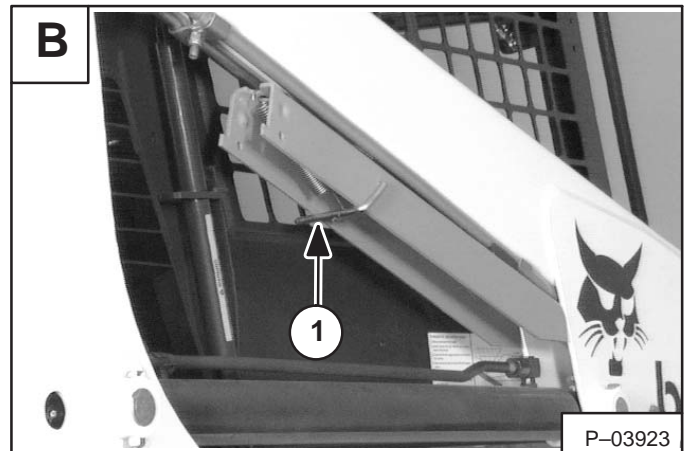
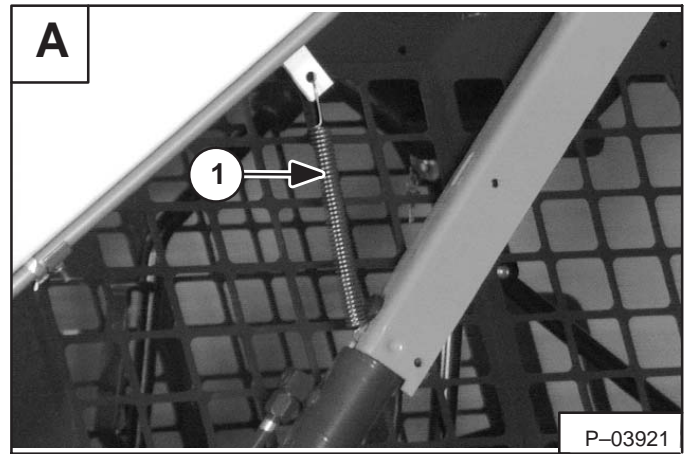

## OPERATOR CAB

### Description

The Bobcat loader has an operator cab (ROPS and FOPS) as standard equipment to protect the operator from rollover and falling objects. Check with your dealer if the operator cab has been damaged. The seat belt must be worn for roll over protection.

**ROPS/FOPS** Roll Over Protective Structure per SAE J104 and ISO 3471, and Falling Object Protective Structure per SAE J1043 and ISO 3449, Level I. Level II is available.

**Level I** – Protection from falling bricks, small concrete blocks and hand tools encountered in operations such as highway maintenance, landscaping, and other construction site services.

**Level II** – Protection from falling trees, rocks; for machines involved in site clearing, overhead demolition or forestry.

### Emergency Exit

The front opening on the operator cab and rear window provide exits.

#### Rear Window

Pull on the tag on the top of the rear window to remove the rubber cord [A].

Push the rear window out of the rear of the operator cab.

Exit through the rear of the operator cab [B].

**NOTE: When an Operator Cab Enclosure Kit is installed, the window of the front door can be used as an emergency exit. [C]**

Pull the plastic loop at the top of the window in the front door to remove the rubber cord [C].

Push the window out with your foot [D].

Exit through the front door.



## OPERATOR CAB (Cont'd)

### Raising The Operator Cab

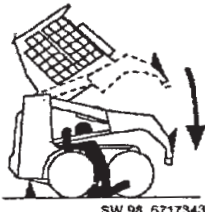
 <b>DANGER</b>	
<b>AVOID DEATH</b> <ul style="list-style-type: none"><li>• Disconnecting or loosening any hydraulic tubeline, hose, fitting, component or a part failure can cause lift arms to drop.</li><li>• Keep out of this area when lift arms are raised unless supported by an approved lift arm support. Replace if damaged. 53145</li></ul>	

Stop the loader on a level surface. Lower the lift arms. Stop the engine. If the lift arms must be up while raising the operator cab, install an approved lift arm support device. (See Page 1-7.)

 <b>WARNING</b>
<b>Never work on a machine with the lift arms up unless the lift arms are secured by an approved lift arm support device. Failure to use an approved lift arm support device can allow the lift arms or attachment to fall and cause injury or death.</b> W-2059-0598

If equipped with with mechanical hand controls:

Disconnect the control linkage joint from the bottom hole (work position) and move to the TOP hole on the control handle (both sides) [A].

Both control handles must be in the vertical position so there will be no cab interference with the steering levers when the operator cab is raised or lowered.

 <b>WARNING</b>
<b>Before the cab or the lift arms are raised for service, jackstands must be put under the rear corners of the frame. Failure to use jackstands can allow the machine to tip backward causing injury or death.</b> W-2014-0895
<b>AVOID INJURY OR DEATH</b>
<b>Accidental movement of the loader, the lift arms or the attachment can occur if the lift or tilt control handles are not positioned correctly before lifting or lowering the cab.</b>
<b>Move control linkage to top hole in handles as shown, so cab does not hit handles when being lifted or lowered.</b> W-2157-0594

Loosen and remove the nut and plate (both sides) from the front corner of the operator cab [B].

 <b>WARNING</b>
<b>Never modify operator cab by welding, grinding, drilling holes or adding attachments unless instructed to do so by Bobcat Company. Changes to the cab can cause loss of operator protection from rollover and falling objects, and result in injury or death.</b> W-2069-1299
<b>AVOID INJURY OR DEATH</b>
<b>When operator cab is equipped with a cab enclosure kit (front door, side windows and top window) and other accessories, the cab will not stay in the fully raised position. Use a chain hoist to secure cab in fully raised position or lower cab until it rests against the cab latch on the gas spring.</b> W-2156-0594

<b>IMPORTANT</b>
<b>Use care when raising or lowering the operator cab to prevent damaging the shaft of the lift arm by-pass control.</b> I-2070-0596

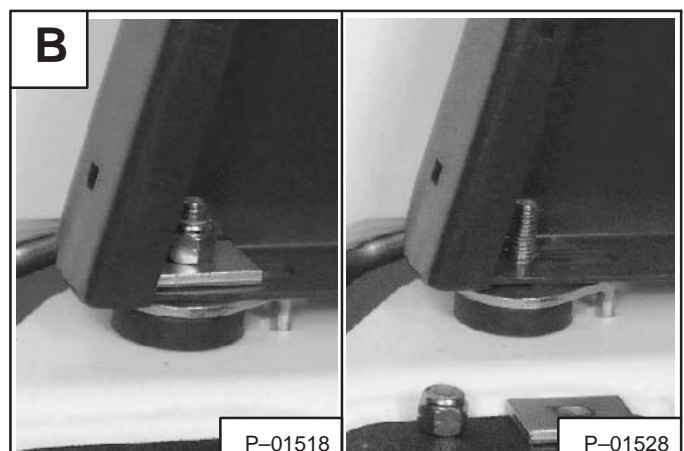
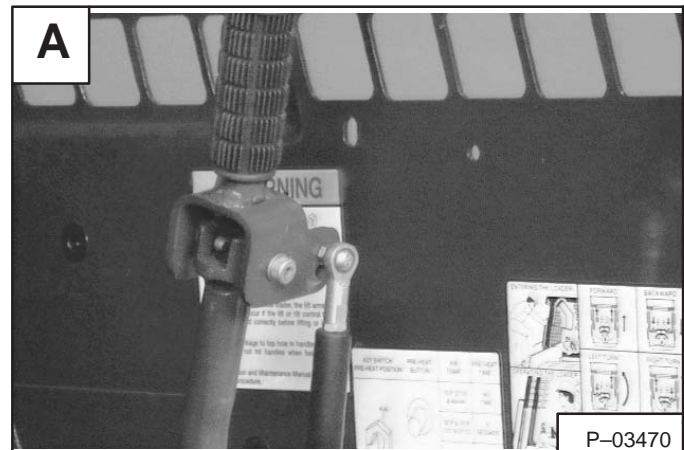

## OPERATOR CAB (Cont'd)

### Raising The Operator Cab (Cont'd)

Lift on the grab handle and bottom of the operator cab slowly until the cab latching mechanism engages and the cab is all the way up [A].



### Lowering The Operator Cab

**NOTE:** Make sure the seat bar is fully raised or lowered when lowering the cab. Use the grab handles to lower the cab.

Pull down on the bottom of the operator cab until it stops at the latching mechanism. Release the latching mechanism and pull the cab all the way down [B].



Install the plate and nut (both sides) [C].

Tighten the nuts to 40–50 ft.-lbs. (54–68 Nm) torque.



If equipped with mechanical hand controls: Move the control linkage from the top hole to the BOTTOM hole (work position) on the control handle (both sides) [D].



## SEAT BAR RESTRAINT SYSTEM (Foot Pedals)

### Description

The seat bar restraint system has a pivoting, spring assist seat bar with arm rests and has spring loaded interlocks for the lift and tilt functions.

The operator controls the use of the seat bar. The seat bar in the down position helps to keep the operator in the seat.

The interlocks require the operator to lower the seat bar in order to operate the foot pedal controls.

When the seat bar is up, the lift and tilt control functions are locked when returned to the NEUTRAL POSITION.

### Seat Bar Inspection

Sit in the seat and fasten the seat belt. Engage the parking brake. Pull the seat bar all the way down. Start the engine. Loaders without seat sensors press the green *PRESS TO OPERATE* Button. Operate each foot pedal to check both the lift and tilt functions. Raise the lift arms until the bucket is about 2 feet (600 mm) off the ground.

Raise the seat bar. Try to move each foot pedal. Pedals must be firmly locked in neutral position. There must be no motion of the lift arms or tilt (bucket) when the pedals are pushed.

Pull the seat bar down. Loaders without seat sensors press the green *PRESS TO OPERATE* Button. Lower the lift arms. Operate the lift pedal. While the lift arms are going up, raise the seat bar and the lift arms should stop.

Lower the seat bar. Loaders without seat sensors press the green *PRESS TO OPERATE* Button. Lower the lift arms and put the bucket flat on the ground. Stop the engine. Raise the seat bar and operate the foot pedals to be sure that the pedals are firmly locked in the neutral position. Unbuckle the seat belt.

### Seat Bar Maintenance

See the *SERVICE SCHEDULE* Page 1–3 and on the loader for correct service interval.

Clean any debris or dirt from the moving parts [A] & [B]. Inspect the linkage bolts and nuts for tightness. The correct torque is 25–28 ft.-lbs. (34–38 Nm).

If the seat bar system does not function correctly, check for free movement of each linkage part. Check for excessive wear. Adjust pedal control linkage. Replace parts that are worn or damaged. Use only genuine Bobcat replacement parts.

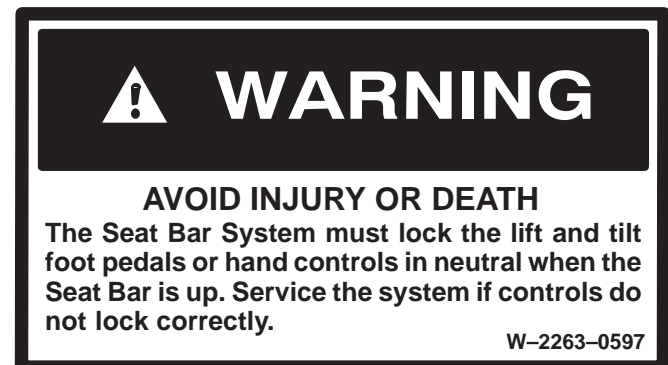
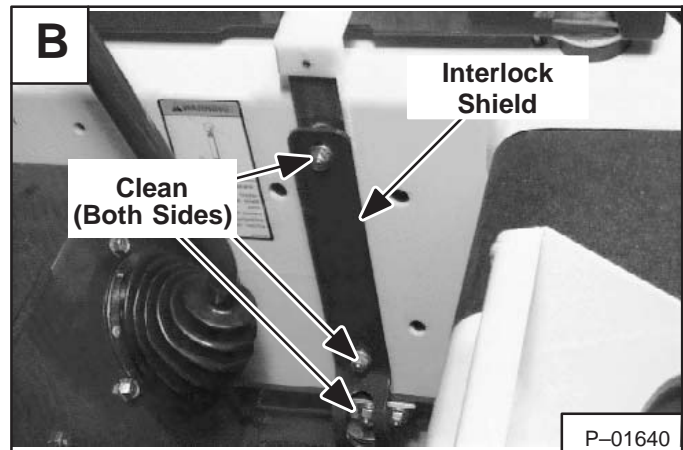
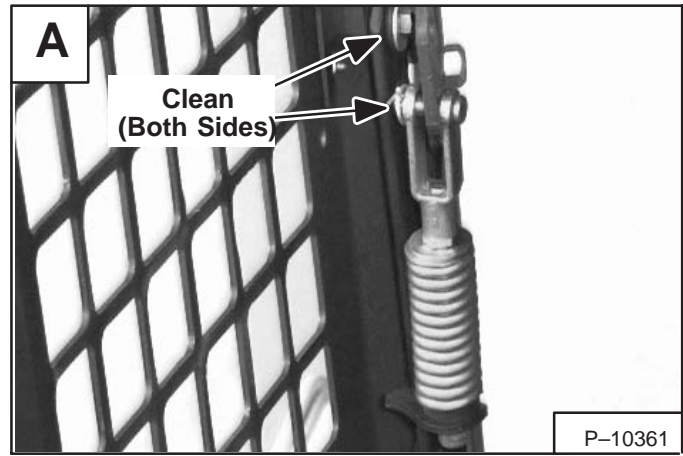

## SEAT BAR RESTRAINT SYSTEM (Mechanical Hand Controls)

### Description

The seat bar restraint system has a pivoting, spring assist seat bar with arm rests and has spring loaded interlocks for the lift and tilt control functions.

The operator controls the use of the seat bar. The seat bar in the down position helps to keep the operator in the seat.

The interlocks require the operator to lower the seat bar in order to operate the hand controls.

When the seat bar is up, the lift and tilt control functions are locked when returned to the NEUTRAL POSITION.

### Seat Bar Inspection

Sit in the seat and fasten the seat belt. Engage the parking brake. Pull the seat bar all the way down. Loaders without seat sensors press the green *PRESS TO OPERATE* Button. Start the engine. Operate each hand control to check both the lift and tilt functions. Raise the lift arms until the bucket is about 2 feet (600 mm) off the ground.

Raise the seat bar. Try to move each hand control. The controls must be firmly locked in neutral position. There must be no motion of the lift arms or tilt (bucket) when the controls are moved.

Pull the seat bar down. Loaders without seat sensors press the green *PRESS TO OPERATE* Button. Lower the lift arms. Operate the lift control. While the lift arms are going up, raise the seat bar and the lift arms should stop.

Lower the seat bar. Lower the lift arms. Loaders without seat sensors press the green *PRESS TO OPERATE* Button and put the bucket flat on the ground. Stop the engine. Raise the seat bar and operate the hand controls to be sure that the controls are firmly locked in the neutral position. Unbuckle the seat belt.

### Seat Bar Maintenance

See the *SERVICE SCHEDULE* Page 1–3 for correct service interval.

Clean any debris or dirt from the moving parts [A] & [B]. Inspect the linkage bolts and nuts for tightness. The correct torque is 25–28 ft.-lbs. (34–38 Nm).

If the seat bar system does not function correctly, check for free movement of each linkage part. Check for excessive wear. Adjust hand control linkage. Replace parts that are worn or damaged. Use only genuine Bobcat replacement parts.

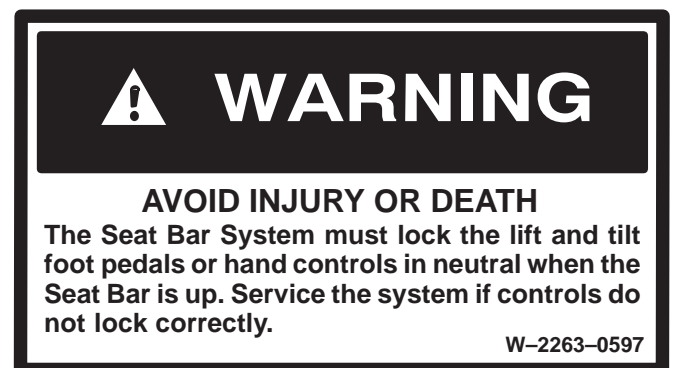
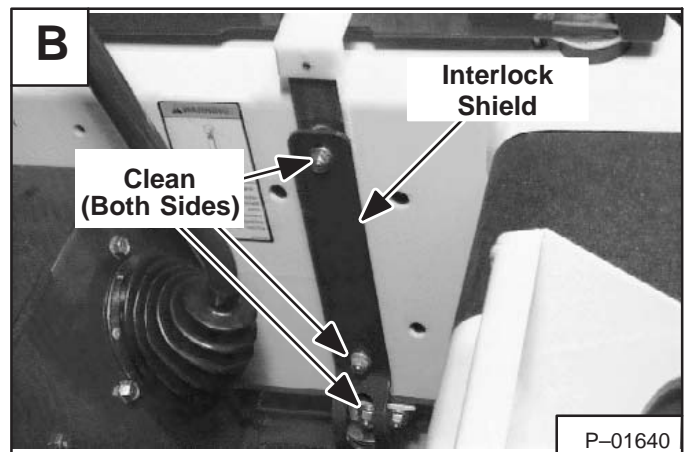
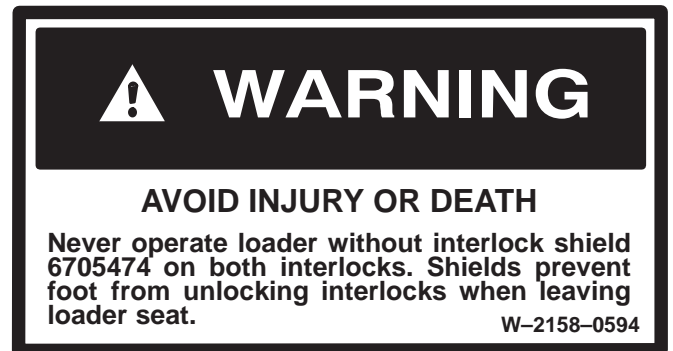
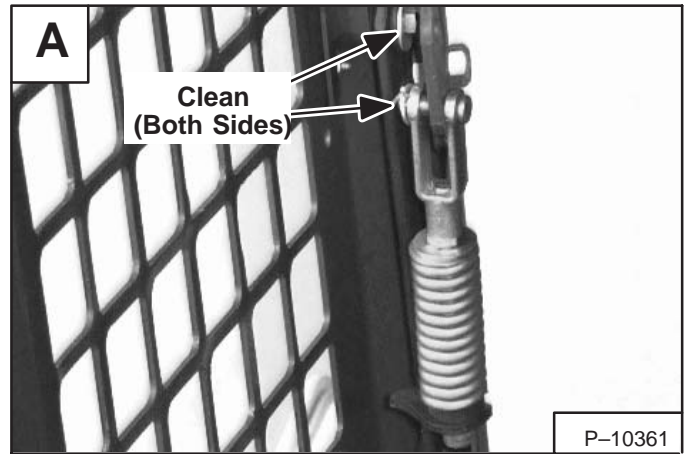

## SEAT BAR RESTRAINT SYSTEM (Advanced Hand Controls)

### Description

The seat bar restraint system has a pivoting seat bar (Item 1) [A] with arm rests.

The operator controls the use of the seat bar. The seat bar in the down position helps to keep the operator in the seat.

When the seat bar is down and the green *PRESS TO OPERATE* Button is activated, the lift, tilt, and traction drive functions can be operated.

When the seat bar is up, the lift, tilt, and traction drive functions are deactivated.

### Seat Bar Inspection

Sit in the operator's seat. Turn the key ON, lower the seat bar and press the green *PRESS TO OPERATE* Button. Both lights on the left handle should be ON.

Move each hand control back and forth. You should hear the *zip-zip* sound of the lift and tilt actuators moving the control valve spools (under the seat).

Raise the seat bar fully. Both lights on the left handle should be OFF.

Move each hand control back and forth. There must be no *zip-zip* sound of the lift or tilt actuators. If either actuator makes a sound while the seat bar is raised, contact your dealer for service.

### Seat Bar Maintenance

See the *SERVICE SCHEDULE* Page 1–3 for correct service interval.

Clean any debris or dirt from the moving parts [B].

If the seat bar system does not function correctly replace parts that are worn or damaged. Use only genuine Bobcat replacement parts.

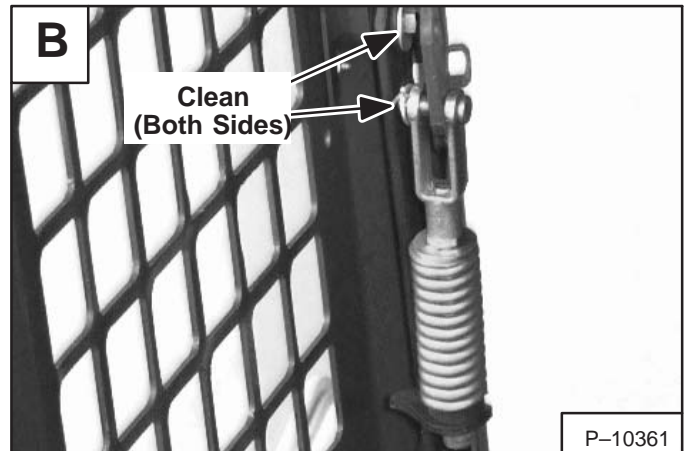
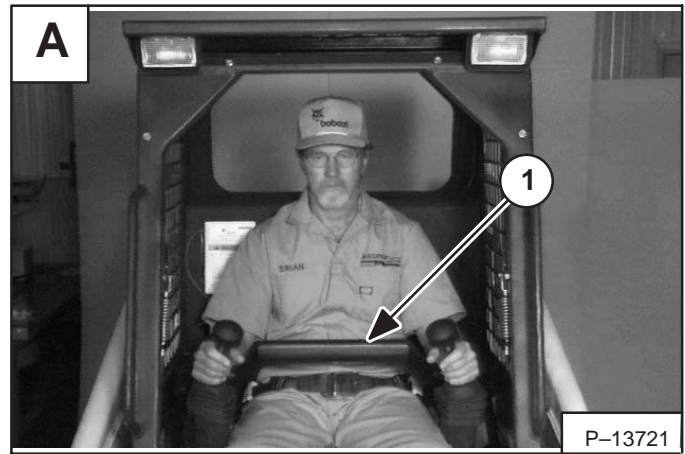

## **WARNING**

**Before you leave the operator's seat:**

- Lower the lift arms, put the attachment flat on the ground.
- Stop the engine.
- Engage the parking brake.
- Raise seat bar.
- (*Advanced Hand Controls*) Move the hand controls to the **NEUTRAL POSITION** to make sure that both lift and tilt functions are deactivated.

The seat bar system must deactivate the lift and tilt control functions when the seat bar is up. Service the system if hand controls do not deactivate.

W-2321-0698

## AIR CLEANER SERVICE

### Replacing Filter Element

**WITH CONDITION INDICATOR (Without BOSS®):** Replace the large (outer) filter element only when the red ring shows in the window of the condition indicator (Item 1) [A].

**NOTE:** Before replacing the filter element, push the button on the condition indicator (Item 2) [A]. Start the engine. If the red ring does not show, do not replace the filter element.

**WITH BOSS® OPTION:** It is important to change the air filter element only when the service codes (on the BOSS® option instrument panel) shows the symbols [AF.2] [B].

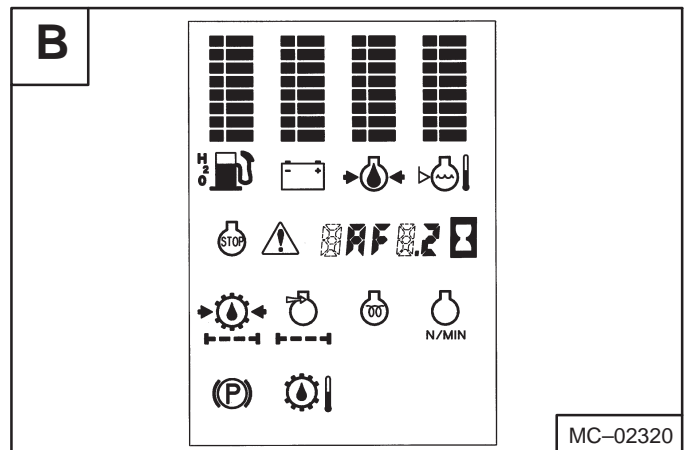
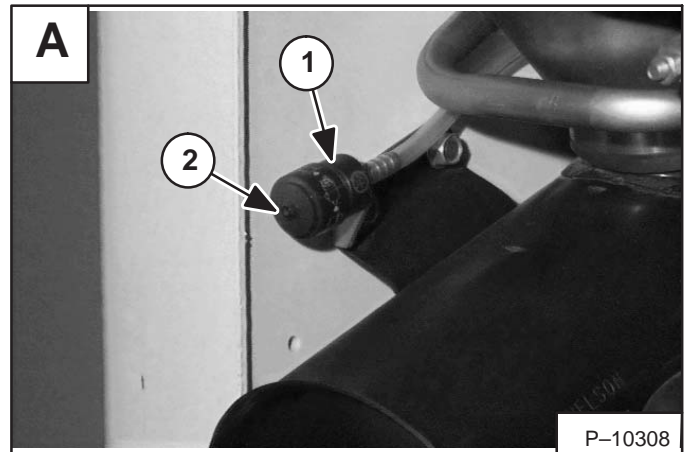

Open the rear door.

Remove the dust cover wing nut (Item 1) [C].

Remove the dust cover (Item 2) [C].

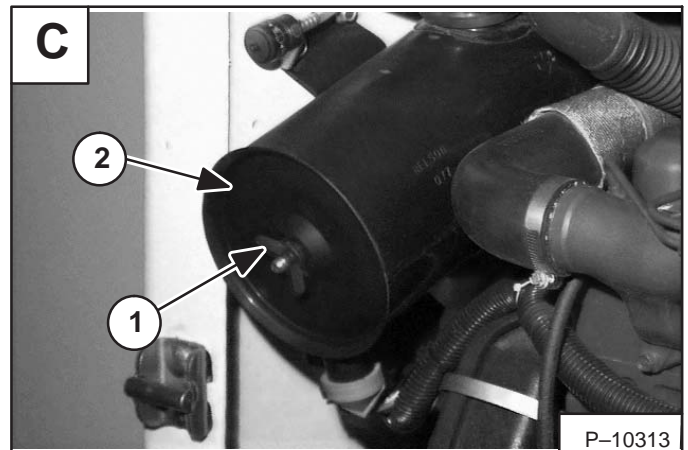

Remove the wing nut (Item 1) [D] from the large air filter element.

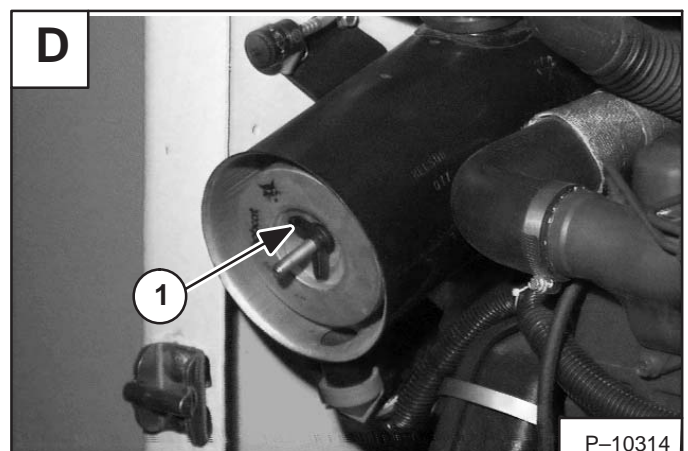

## AIR CLEANER SERVICE (Cont'd)

### Replacing Filter Element (Cont'd)

Remove the large filter element [A].

**NOTE: Be sure all sealing surfaces are free of dirt and debris.**

Install the new filter element and washer and tighten the wing nut.

**NOTE: Be sure sealing washer(s) is installed in its original location.**

Install the dust cover, washer and tighten the wing nut.

Check the air intake hose for damage. Check the air cleaner housing for damage. Check to make sure all connections are tight.

Only replace the inner filter element under the following conditions:

- Replace the inner filter element every third time the outer filter is replaced.
- Press the button to remove the red ring in the condition indicator after the outer element has been replaced. Start the engine and run at full RPM. If the red ring shows again, replace the inner filter element.
- **BOSS® Only:** If the service codes show symbols **AF.2** during full engine speed, replace the inner filter element only after the outer filter element has been changed.

Remove the outer element. (See Page 1–1.)

Remove the inner filter wing nut (Item 1) [B].

Remove the inner filter element [C].

Install a new filter and tighten the wing nut.

Close the rear door before operating the loader.

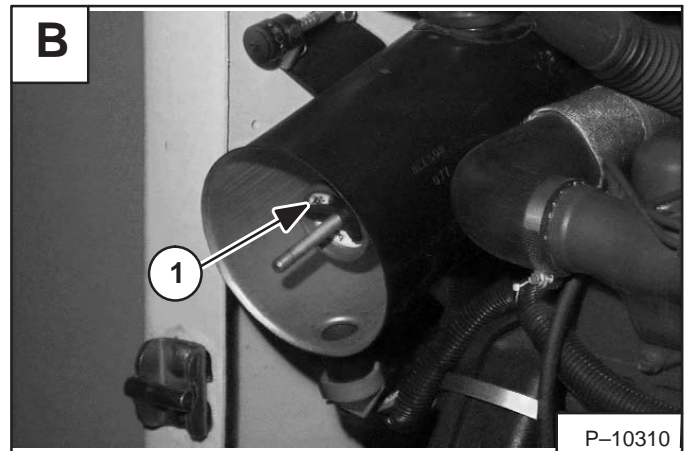



**Suggest:**

**If the above button click is invalid.**

**Please download this document**

**first, and then click the above link**

**to download the complete manual.**

**Thank you so much for reading**

## FUEL SYSTEM

### Fuel Specifications

Use only clean, high quality diesel fuel, Grade No. 2 or Grade No. 1.

The following is one suggested blending guideline which should prevent fuel gelling problems at cold temperatures:

Temp. F° (C°)	No. 2	No.1
+15° (9°)	100%	0%
Down to -20° (-29°)	50%	50%
Below -20° (29°)	0%	100%

Contact your fuel supplier for local recommendations.

### Filling The Fuel Tank



Remove the fuel fill cap (Item 1) [A].

Use a clean, approved safety container to add fuel of the correct specifications. Add fuel only in an area that has free movement of air and no open flames or sparks. **NO SMOKING!** [B].

Install and tighten the fuel fill cap [A].

### Fuel Filter

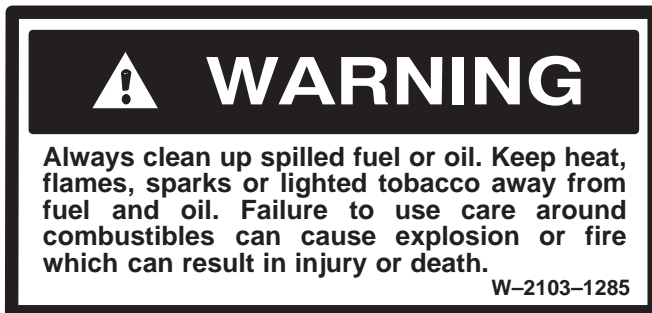

See the *SERVICE SCHEDULE* Page 1-3 for the service interval when to remove the water from and replacing the fuel filter.

Open the rear door.

Loosen the drain (Item 1) [C] at the bottom of the filter element to drain water from the filter.

Remove the filter element (Item 2) [C].

Clean the area around the filter housing.

Put oil on the seal of the new filter element. Install the fuel filter, and hand tighten.

Remove the air from the fuel system. (See Page 1-18.)

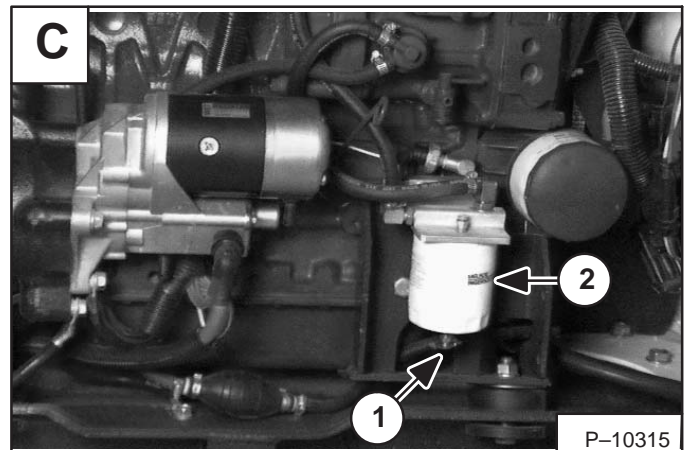
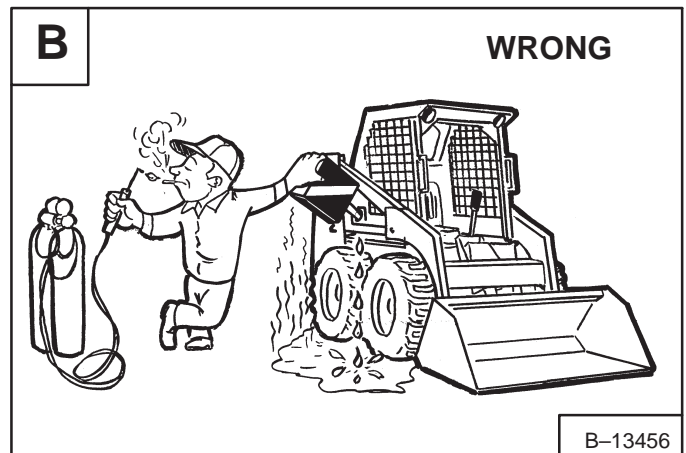
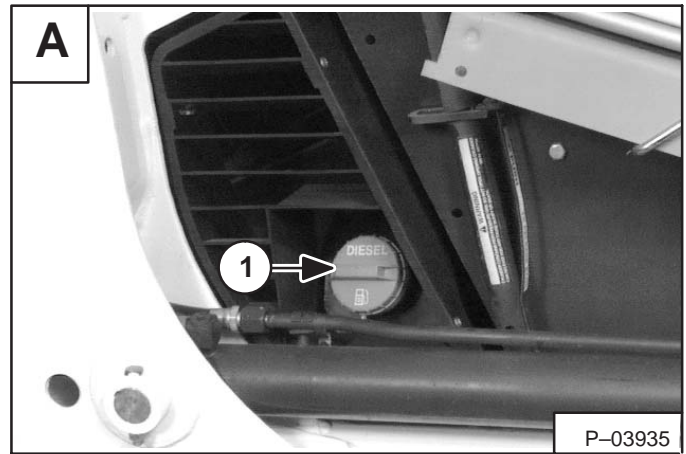

**<https://www.ebooklibonline.com>**

Hello dear friend!

Thank you very much for reading.

Enter the link into your browser.

The full manual is available for immediate download.

**<https://www.ebooklibonline.com>**