

442



Bobcat®

Service Manual

**S/N 522311001 & Above
S/N 528911001 & Above
S/N 528611001 & Above**

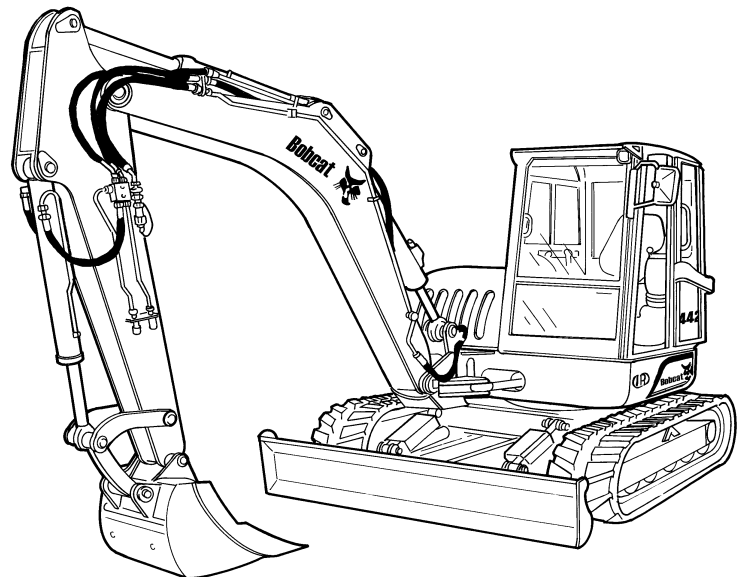

MAINTENANCE SAFETY



WARNING

Instructions are necessary before operating or servicing machine. Read and understand the Operation & Maintenance Manual, Operator's Handbook and signs (decals) on machine. Follow warnings and instructions in the manuals when making repairs, adjustments or servicing. Check for correct function after adjustments, repairs or service. Untrained operators and failure to follow instructions can cause injury or death.

W-2003-0903



Safety Alert Symbol: This symbol with a warning statement, means: "Warning, be alert! Your safety is involved!" Carefully read the message that follows.

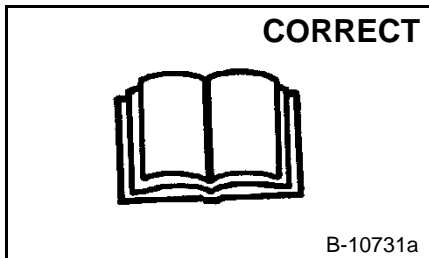

⚠ Never service the Bobcat Hydraulic Excavator without instructions.

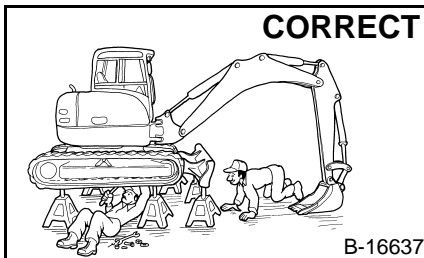

⚠ Use the correct procedure to lift and support the excavator.
⚠ Always lift the blade fully before installing jackstands.

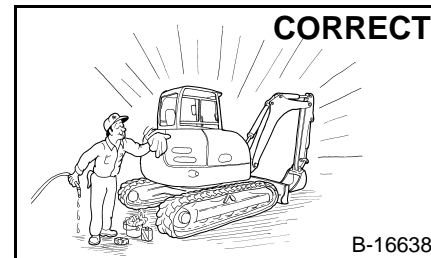

⚠ Cleaning and maintenance are required daily.

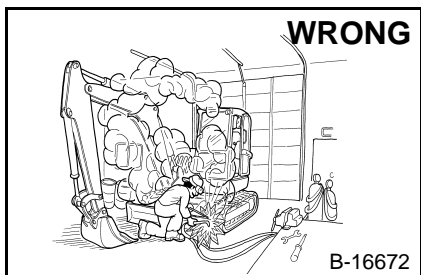

⚠ Have good ventilation when welding or grinding painted parts.
⚠ Wear dust mask when grinding painted parts. Toxic dust and gas can be produced.

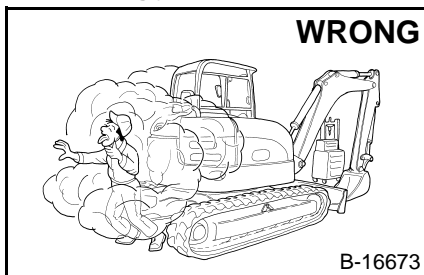

⚠ Vent exhaust to outside when engine must be run for service.
⚠ Exhaust system must be tightly sealed. Exhaust Fumes can kill without warning.

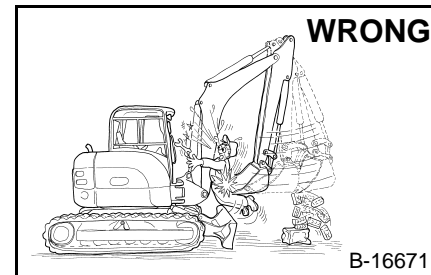

⚠ Always lower the bucket and blade to the ground before doing any maintenance.
⚠ Never modify equipment or add attachments not approved by Bobcat Company.

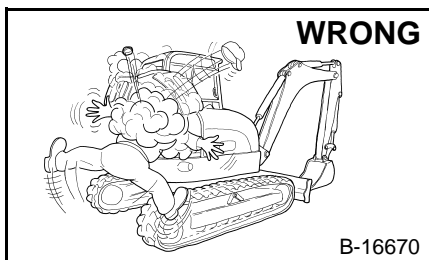

⚠ Stop, cool and clean engine of flammable materials before checking fluids.
⚠ Never service or adjust machine with the engine running unless instructed to do so in the manual.
⚠ Avoid contact with leaking hydraulic fluid or diesel fuel under pressure. It can penetrate the skin or eyes.
⚠ Never fill fuel tank with engine running, while smoking or when near open flame.

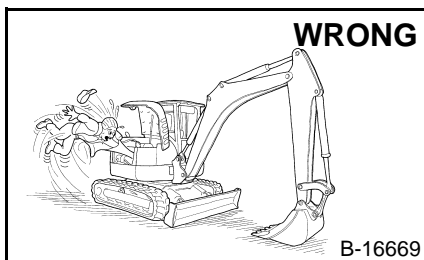

⚠ Keep body, jewelry and clothing away from moving parts, electrical contact, hot parts and exhaust.
⚠ Wear eye protection to guard from battery acid, compressed springs, fluids under pressure and flying debris when engines are running or tools are used. Use eye protection approved for type of welding.
⚠ Keep tailgate closed except for service, Close and latch tailgate before operating the excavator.



⚠ Lead-acid batteries produce flammable and explosive gases.
⚠ Keep arcs, sparks, flames and lighted tobacco away from batteries.
⚠ Batteries contain acid which burns eyes or skin on contact. Wear protective clothing. If acid contacts body, flush well with water. For eye contact flush well and get immediate medical attention.

Maintenance procedures which are given in the Operation & Maintenance Manual can be performed by the owner/operator without any specific technical training. Maintenance procedures which are **not** in the Operation & Maintenance Manual must be performed **ONLY BY QUALIFIED BOBCAT SERVICE PERSONNEL**. Always use genuine Bobcat replacement parts. The Service Safety Training Course is available from your Bobcat dealer.

ALPHABETICAL INDEX

ACCUMULATOR.....	20-01	FAN/FUEL PUMP BELT	10-01
AIR CLEANER	10-01, 60-01	FLOORMAT	40-01
AIR CONDITIONING COMPRESSOR BELT	10-01	FLYWHEEL.....	60-01
AIR CONDITIONING SERVICE	70-01	FRESH AIR FILTER	10-01
AIR CONDITIONING SYSTEM FLOW	70-01	FRONT CAB LIGHT	50-01
ALTERNATOR	50-01	FUEL COOLANT AND LUBRICANTS.....	SPEC-01
ALTERNATOR BELT	10-01	FUEL LEVEL SENDER	50-01
ARM	40-01	FUEL SYSTEM.....	10-01
ARM CYLINDER	20-01	FUEL TANK	40-01
AUXILIARY HYDRAULIC FLOW CONTROL/ HYDRAULIC BREAKER APPLICATION VALVE.....	20-01	GENERAL AIR CONDITIONING SERVICE GUIDELINES	70-01
AUXILIARY HYDRAULIC FLOW CONTROL VALVE	20-01	GREASE CYLINDER	30-01
AUXILIARY HYDRAULICS SELECTOR VALVE.....	20-01	HEATER/AC FAN	70-01
BASIC TROUBLESHOOTING	70-01	HEATER COIL/EVAPORATOR.....	70-01
BATTERY	50-01	HEATER VALVE	70-01
BATTERY DISCONNECT SWITCH.....	50-01	HORN	40-01
BLADE	30-01	HYDRAULIC BREAKER APPLICATION VALVE	20-01
BLADE CYLINDER	20-01	HYDRAULIC EXCAVATOR SPECIFICATIONS. SPEC-01	
BLADE FLOAT VALVE	20-01	HYDRAULIC FILTER MOUNT.....	20-01
BLADE VALVE	20-01	HYDRAULIC FLUID SPECIFICATIONS.....	SPEC-01
BOOM	40-01	HYDRAULIC GEAR PUMP	20-01
BOOM CYLINDER	20-01	HYDRAULIC PISTON PUMP	20-01
BOOM LOAD HOLDING VALVE	20-01	HYDRAULIC PISTON PUMP DRIVE COUPLER.....	20-01
BOOM OFFSET CYLINDER.....	20-01	HYDRAULIC RESERVOIR.....	20-01
BOOM OFFSET VALVE	20-01	HYDRAULIC SYSTEM	10-01
BUCKET	40-01	HYDRAULIC SYSTEM INFORMATION	20-01
BUCKET CYLINDER	20-01	INSTRUMENT PANEL.....	50-01
CAB.....	40-01	JOYSTICK CONTROL PATTERN SELECTOR VALVE.....	20-01
CAB TILT PROCEDURE.....	10-01	JOYSTICK LOCKOUT/TWO SPEED VALVE	20-01
COMPONENTS	70-01	LEFT CONSOLE	40-01
COMPRESSOR	70-01	LEFT CONTROL LEVER (JOYSTICK)	20-01
CONDENSER	70-01	LIFTING AND BLOCKING THE EXCAVATOR	10-01
CONTROL LEVERS	40-01	LIFTING THE EXCAVATOR	10-01
CONVERSIONS	SPEC-01	LOWER TRACK ROLLER.....	30-01
COOLING SYSTEM.....	10-01	LUBRICATION OF THE EXCAVATOR	10-01
COUNTER WEIGHT	40-01	MUFFLER.....	60-01
DUMP VALVE	20-01	OIL COOLER.....	20-01
ELECTRICAL SYSTEM INFORMATION	50-01	OIL TEMPERATURE REGULATOR.....	20-01
ENGINE	60-01	OPERATOR CAB	10-01
ENGINE BOLT TORQUE	SPEC-01	PORT RELIEF VALVES.....	20-01
ENGINE COMPONENTS AND TESTING	60-01	PRESSURE REDUCING VALVE.....	20-01
ENGINE LUBRICATION SYSTEM.....	10-01	PRESSURE SWITCH.....	70-01
ENGINE SPECIFICATIONS.....	SPEC-01		
ENGINE SPEED CONTROL	40-01		
EVAPORATOR/HEATER UNIT	70-01		
EXCAVATOR BOLT TORQUE	SPEC-01		
EXPANSION VALVE	70-01		

<https://www.ebooklibonline.com>

Hello dear friend!

Thank you very much for reading.

Enter the link into your browser.

The full manual is available for immediate download.

<https://www.ebooklibonline.com>

ALPHABETICAL INDEX (CONT'D)

RADIATOR/OIL COOLER.....	60-01
REAR COVER	10-01, 40-01
RECEIVER/DRYER	70-01
RECONDITIONING THE ENGINE	60-01
REGULAR MAINTENANCE	70-01
RELIEF VALVES.....	20-01
RIGHT CONSOLE	40-01
RIGHT CONTROL LEVER (JOYSTICK)	20-01
RIGHT SIDE COVER	10-01, 40-01
SAFETY	70-01
SEAT AND SEAT MOUNT.....	40-01
SECONDARY FRONT AUXILIARY VALVE	20-01
SERVICE SCHEDULE	10-01
SIX SPOOL HYDRAULIC CONTROL VALVE	20-01
STARTER	50-01
SWING BRAKE RELEASE VALVE.....	20-01
SWING BRAKE VALVE	20-01
SWING FRAME	40-01
SWING MOTOR	20-01
SWING MOTOR DRIVE CARRIER	20-01
SWIVEL JOINT.....	20-01
SYSTEM CHARGING AND RECLAMATION	70-01
SYSTEM TROUBLESHOOTING CHART	70-01
TEMPERATURE/PRESSURE	70-01
THERMOSTAT.....	70-01
THREE SPOOL HYDRAULIC CONTROL VALVE	20-01
TORQUE SPECIFICATIONS FOR BOLTS.....	SPEC-01
TRACK DAMAGE IDENTIFICATION.....	30-01
TRACK FRAME	30-01
TRACK IDLER	30-01
TRACKS	30-01
TRANSPORTING THE EXCAVATOR.....	10-01
TRAVEL LEVER/FOOT PEDAL VALVE	20-01
TRAVEL MOTOR.....	10-01, 20-01
TROUBLESHOOTING.....	60-01
TWO SPEED SWITCH	50-01
UPPER TRACK ROLLER.....	30-01
UPPERSTRUCTURE	40-01
UPGRADED AIR CONDITIONING SYSTEM	70-01
WIPER MOTOR.....	50-01

CONTENTS

FOREWORD.....	III
SAFETY INSTRUCTIONS	V
DELIVERY REPORT.....	X
SERIAL NUMBER LOCATIONS	IX
BOBCAT EXCAVATOR IDENTIFICATION	XI
SAFETY AND MAINTENANCE.....	10-01
HYDRAULIC SYSTEM	20-01
UNDERCARRIAGE.....	30-01
UPPERSTRUCTURE & SWING SECTION	40-01
ELECTRICAL SYSTEM AND ANALYSIS	50-01
ENGINE SERVICE	60-01
HEATING, VENTILATION, AIR CONDITIONING	70-01
SPECIFICATIONS.....	SPEC-01

**SAFETY &
MAINTENANCE**

**HYDRAULIC
SYSTEM**

**UNDER-
CARRIAGE**

**UPPER-
STRUCTURE &
SWING SECTION**

**ELECTRICAL
SYSTEM AND
ANALYSIS**

**ENGINE
SERVICE**

HVAC

SPECIFICATIONS

FOREWORD

This manual is for the Bobcat Hydraulic Excavator mechanic. It provides necessary servicing and adjustment procedures for the hydraulic excavator and its component parts and systems. Refer to the Operation & Maintenance Manual for operating instructions, starting procedure, daily checks, etc.

A general inspection of the following items must be made after the hydraulic excavator has had service or repair:

1. Check that the ROPS/TOPS/FOPS is in good condition and is NOT modified.

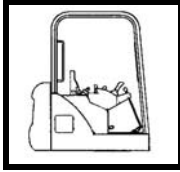

2. Check that ROPS mounting hardware is tightened and is Bobcat approved.

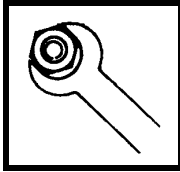

3. The seat belt must be correctly installed, functional and in good condition.

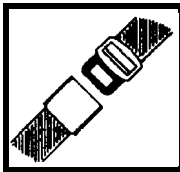

4. Inspect for loose or broken parts or connections.

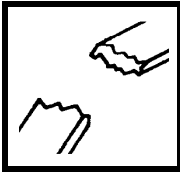

5. Machine signs must be legible and in the correct location.



6. Steering levers, control levers and foot pedals must return to neutral. Check that foot pedals lock and control lever locks are in working order.

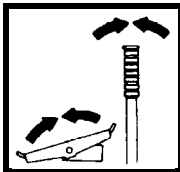

7. Inspect the air cleaner for damage or leaks. Check the condition of the element.

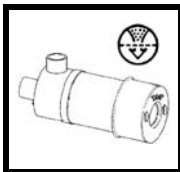

8. Check the electrical charging system.

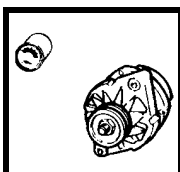

9. Safety treads must be in good condition.

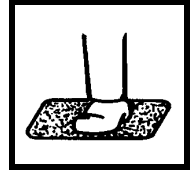

10. Check for correct function of indicator lamps (Optional on some models).

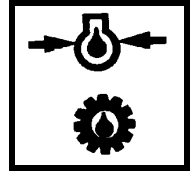

11. Check hydraulic fluid level, engine oil level and fuel supply.

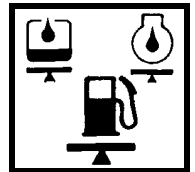

12. Inspect for fuel, oil or hydraulic fluid leaks.

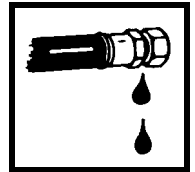

13. Lubricate the excavator.

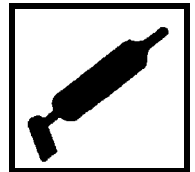

14. Check the condition of the battery and cables.

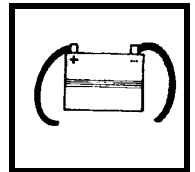

Recommend to the owner that all necessary corrections be made before the machine is returned to service.

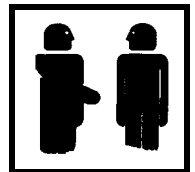

**CALIFORNIA
PROPOSITION 65 WARNING**
Diesel engine exhaust and some of its constituents are known to the state of California to cause cancer, birth defects and other reproductive harm.

SAFETY INSTRUCTIONS



Safety Alert Symbol

This symbol with a warning statement means: "Warning, be alert! Your safety is involved!" Carefully read the message that follows.



WARNING

Instructions are necessary before operating or servicing machine. Read and understand the Operation & Maintenance Manual, Operator's Handbook and signs (decals) on machine. Follow warnings and instructions in the manuals when making repairs, adjustments or servicing. Check for correct function after adjustments, repairs or service. Untrained operators and failure to follow instructions can cause injury or death.

W-2003-0903



WARNING

Warnings on the machine and in the manuals are for your safety. Failure to obey warnings can cause injury or death.

W-2044-1285

IMPORTANT

This notice identifies procedures which must be followed to avoid damage to the machine.

I-2019-0284

The following publications provide information on the safe use and maintenance of the Bobcat machine and attachments:

- The Delivery Report is used to assure that complete instructions have been given to the new owner and that the machine is in safe operating condition.
- The Operation & Maintenance Manual delivered with the machine or attachment contains operating information as well as routine maintenance and service procedures. It is a part of the machine and can be stored in a container provided on the machine. Replacement Operation & Maintenance Manuals can be ordered from your Bobcat dealer.
- Machine signs (decals) instruct on the safe operation and care of your Bobcat machine or attachment. The signs and their locations are shown in the Operation & Maintenance Manual. Replacement signs are available from your Bobcat dealer.
- An Operator's Handbook fastened to the operator cab. It's brief instructions are convenient to the operator. The handbook is available from your dealer in an English edition or one of many other languages. See your Bobcat dealer for more information on translated versions.
- The AEM Safety Manual delivered with the machine gives general safety information.
- The Service Manual and Parts Manual are available from your dealer for use by mechanics to do shop-type service and repair work.
- The Compact Excavator Operator Training Course is available through your local dealer or at www.training.bobcat.com or www.bobcat.com. This course is intended to provide rules and practices of correct operation of the Bobcat excavator. The course is available in English and Spanish versions.
- Service Safety Training Courses are available from your Bobcat dealer or at www.training.bobcat.com or www.bobcat.com. They provide information for safe and correct service procedures.
- The Bobcat compact excavator Safety Video is available from your Bobcat dealer or at www.training.bobcat.com or www.bobcat.com.

SI EXC-1007 SM

442 Excavator
Service Manual

FIRE PREVENTION



Maintenance

The machine and some attachments have components that are at high temperatures under normal operating conditions. The primary source of high temperatures is the engine and exhaust system. The electrical system, if damaged or incorrectly maintained, can be a source of arcs or sparks.

Flammable debris (leaves, straw, etc.) must be removed regularly. If flammable debris is allowed to accumulate, it can cause a fire hazard. Clean often to avoid this accumulation. Flammable debris in the engine compartment is a potential fire hazard.

The operator's area, engine compartment and engine cooling system must be inspected every day and cleaned if necessary to prevent fire hazards and overheating.

All fuels, most lubricants and some coolants mixtures are flammable. Flammable fluids that are leaking or spilled onto hot surfaces or onto electrical components can cause a fire.

Operation

Do not use the machine where exhaust, arcs, sparks or hot components can contact flammable material, explosive dust or gases.

Electrical



Check all electrical wiring and connections for damage. Keep the battery terminals clean and tight. Repair or replace any damaged part or wires that are loose or frayed.

Battery gas can explode and cause serious injury. Use the procedure in the Operation & Maintenance Manual for connecting the battery and for jump starting. Do not jump start or charge a frozen or damaged battery. Keep any open flames or sparks away from batteries. Do not smoke in battery charging area.

Hydraulic System

Check hydraulic tubes, hoses and fittings for damage and leakage. Never use open flame or bare skin to check for leaks. Hydraulic tubes and hoses must be properly routed and have adequate support and secure clamps. Tighten or replace any parts that show leakage.

Always clean fluid spills. Do not use gasoline or diesel fuel for cleaning parts. Use commercial nonflammable solvents.

Fueling



Stop the engine and let it cool before adding fuel. No smoking! Do not refuel a machine near open flames or sparks. Fill the fuel tank outdoors.

Starting

Do not use ether or starting fluids on any engine that has glow plugs. These starting aids can cause explosion and injure you or bystanders.

Use the procedure in the Operation & Maintenance Manual for connecting the battery and for jump starting.

Spark Arrestor Exhaust System

The spark arrestor exhaust system is designed to control the emission of hot particles from the engine and exhaust system, but the muffler and the exhaust gases are still hot.

Check the spark arrestor exhaust system regularly to make sure it is maintained and working properly. Use the procedure in the Operation & Maintenance Manual for cleaning the spark arrestor muffler (if equipped).

FIRE PREVENTION (CONT'D)

Welding And Grinding

Always clean the machine and attachment, disconnect the battery, and disconnect the wiring from the Bobcat controllers before welding. Cover rubber hoses, battery and all other flammable parts. Keep a fire extinguisher near the machine when welding.

Have good ventilation when grinding or welding painted parts. Wear dust mask when grinding painted parts. Toxic dust or gas can be produced.

Dust generated from repairing nonmetallic parts such as hoods, fenders or covers can be flammable or explosive. Repair such components in a well ventilated area away from open flames or sparks.

Fire Extinguishers

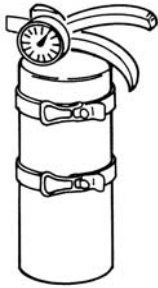

Know where fire extinguishers and first aid kits are located and how to use them. Inspect the fire extinguisher and service the fire extinguisher regularly. Obey the recommendations on the instructions plate.

SERIAL NUMBER LOCATIONS

Always use the serial number of the excavator when requesting service information or when ordering parts. Early or later models (identification made by serial number) may use different parts, or it may be necessary to use a different procedure in doing a specific service operation.

Excavator Serial Number

Figure 1

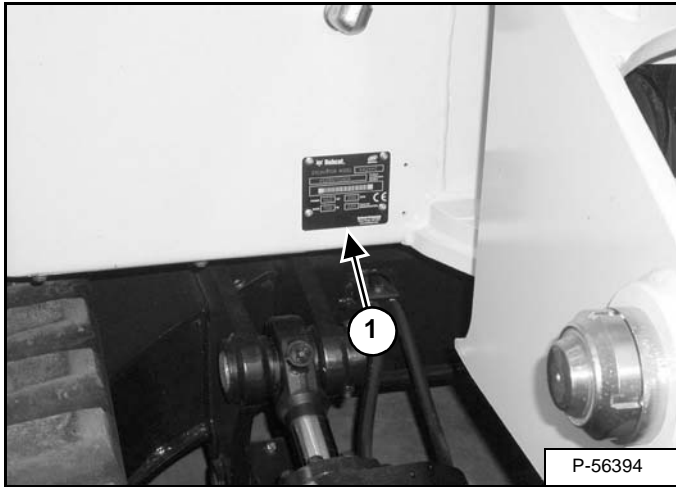

The excavator serial number plate (Item 1) is located on the frame of the machine in the location shown [Figure 1].

Explanation of Excavator Serial Number:

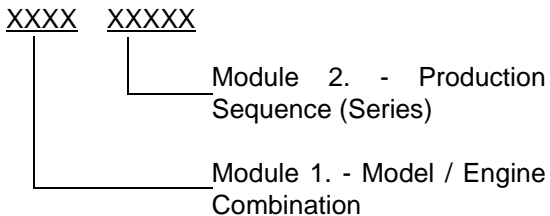

1. The four digit Model/Engine Combination Module number identifies the model number and engine combination.

2. The five digit Production Sequence Number identifies the order which the excavator is produced.

Engine Serial Number

Figure 2

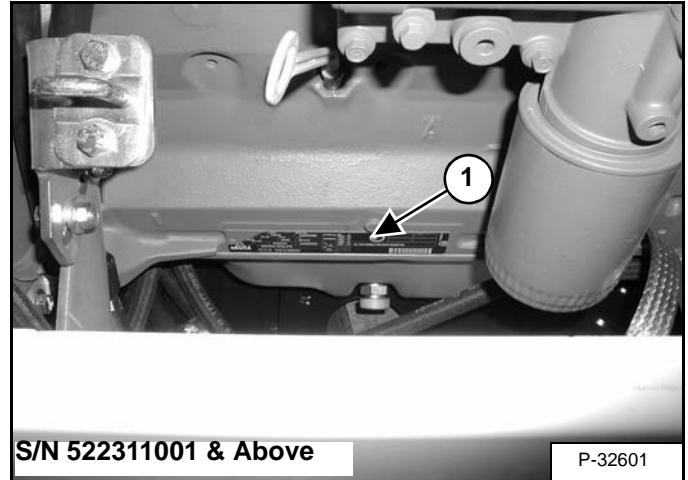
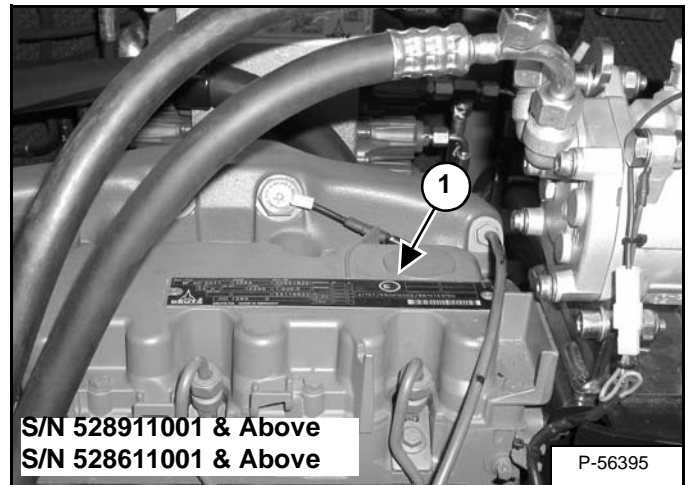

Figure 3



The engine serial number (Item 1) [Figure 2] & [Figure 3] is located on the engine in the locations shown.

DELIVERY REPORT

Figure 4

The diagram shows a form titled "DELIVERY REPORT". The form is divided into several sections. At the top, there is a header section with the title "DELIVERY REPORT" and several horizontal lines for text. Below this, the form is split into two columns. The left column contains a section with a dark background and the word "WARNING" in white, followed by several horizontal lines. The right column contains several horizontal lines. At the bottom of the form, there is a small rectangular box containing the text "B-16315".

The delivery report must be filled out by the dealer and signed by the owner or operator when the Bobcat Excavator is delivered. An explanation of the form must be given to the owner. Make sure it is filled out completely **[Figure 4]**.

BOBCAT EXCAVATOR IDENTIFICATION

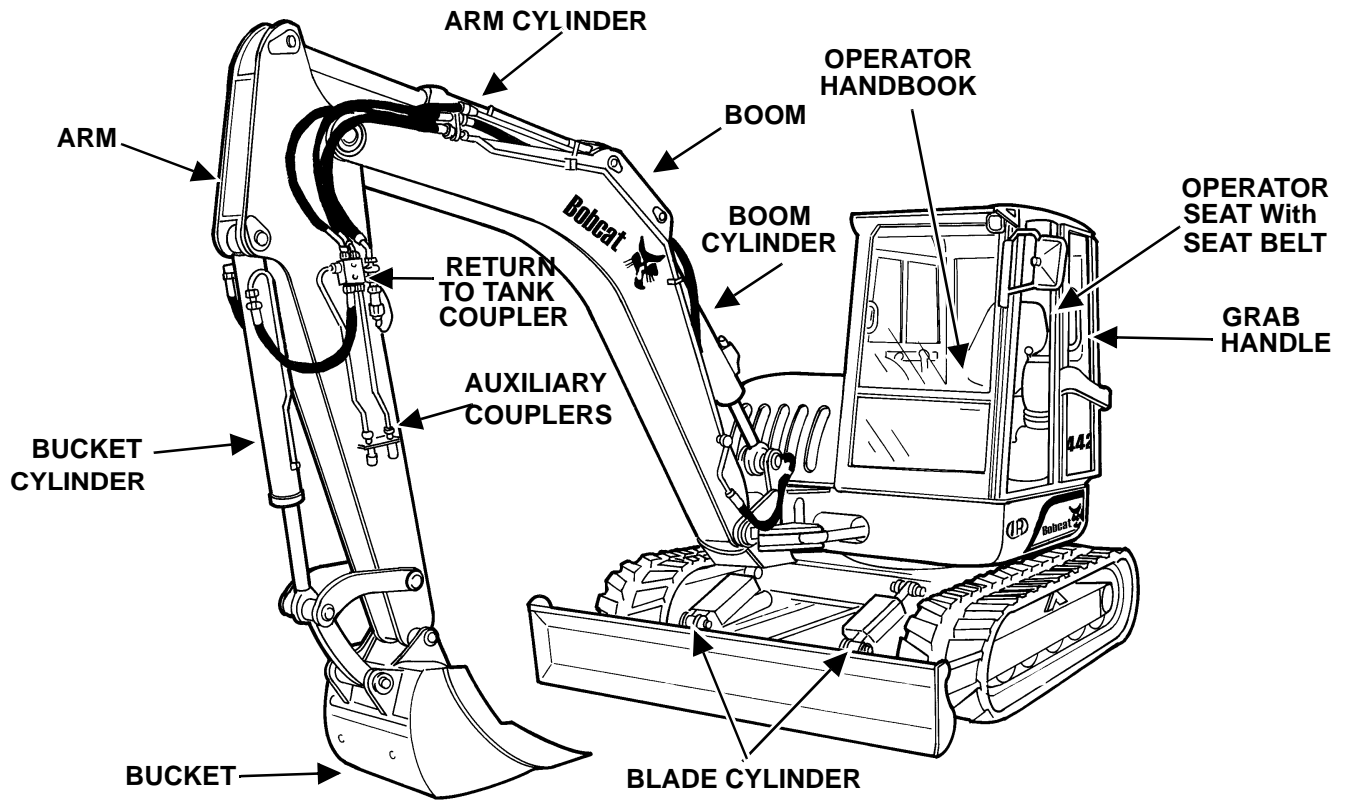

P-16589

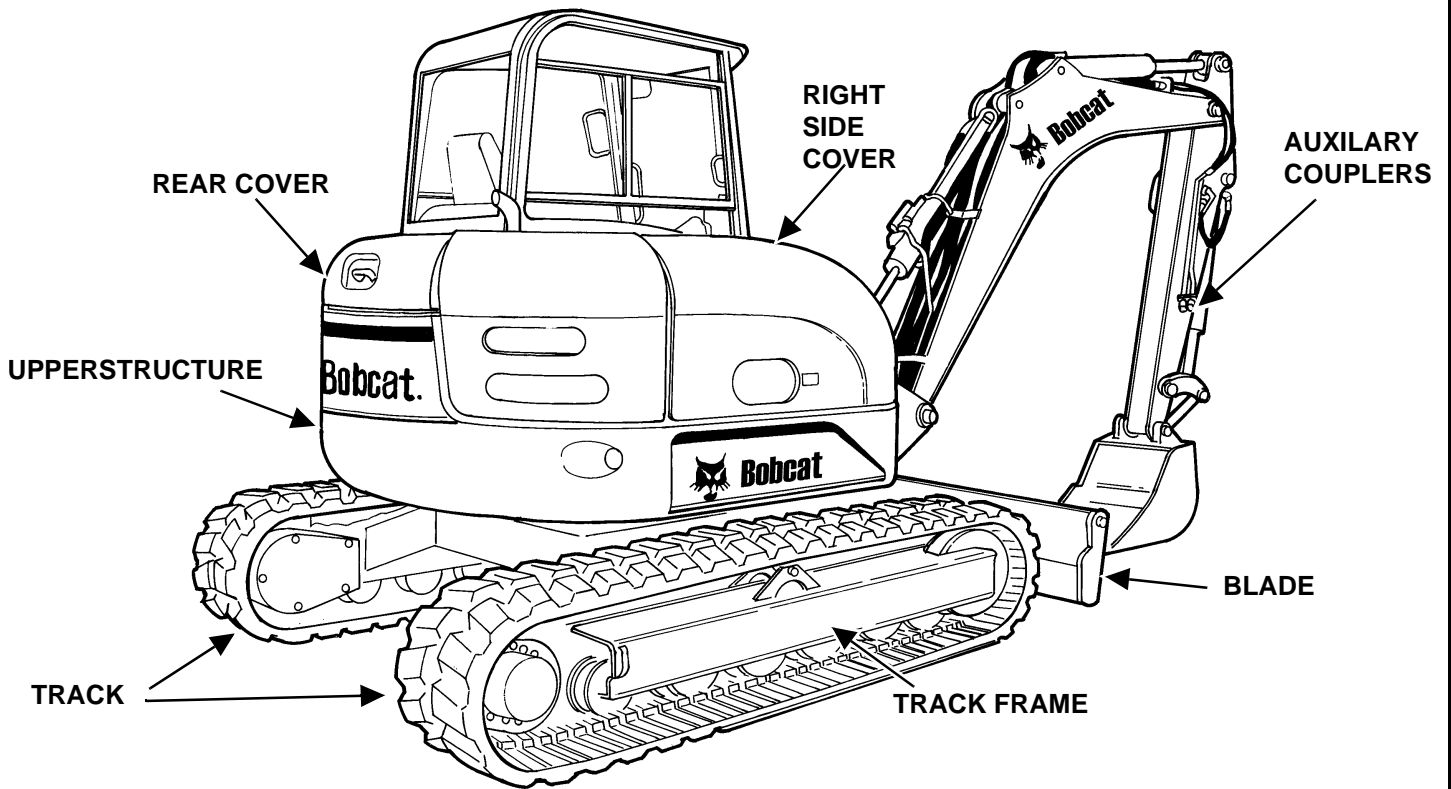

B-16590

SAFETY AND MAINTENANCE

AIR CLEANER 10-60-1
 Daily Check 10-60-1
 Replacing The Filters 10-60-1

AIR CONDITIONING COMPRESSOR BELT (S/N 522311001 &
 ABOVE) 10-150-1
 Adjusting Belt Tension 10-150-1

AIR CONDITIONING COMPRESSOR BELT (S/N 528911001 &
 ABOVE AND S/N 528611001 & ABOVE) 10-151-1
 Adjusting Belt Tension 10-151-1

ALTERNATOR BELT 10-130-1
 Adjusting Belt Tension 10-130-1

CAB TILT PROCEDURE 10-160-1
 Installing The Cab Tilt Hinges 10-160-1
 Tilting The Cab 10-160-2

COOLING SYSTEM 10-70-1
 Checking Coolant Level (S/N 522311001 & Above) 10-70-1
 Cleaning The Cooling System 10-70-1
 Replacing The Coolant (S/N 522311001 & Above) 10-70-2

ENGINE LUBRICATION SYSTEM 10-90-1
 Checking Engine Oil 10-90-1
 Replacing Oil And Filter 10-90-2

FAN/FUEL PUMP BELT 10-140-1
 Adjusting Belt Tension (S/N 522311001 & Above) 10-140-1

FRESH AIR FILTER (S/N 522311001 & ABOVE) 10-61-1
 Removal And Installation 10-61-1

FRESH AIR FILTER (S/N 528911001 & ABOVE AND S/N 528611001
 & ABOVE) 10-62-1
 Removal And Installation 10-62-1

Continued On Next Page

SAFETY AND MAINTENANCE (CONT'D)

FUEL SYSTEM	10-80-1
Draining The Fuel Tank	10-80-8
Filling The Fuel Tank	10-80-1
Fuel Filter Removal And Installation	10-80-7
Fuel Specifications	10-80-1
Pre-Filter Installation (S/N 522311001 & Above)	10-80-4
Pre-Filter Removal (S/N 522311001 & Above)	10-80-3
Pre-Filter Removal And Installation (S/N 528911001 & Above And S/N 528611001 & Above)	10-80-6
Removing Water From The Pre-Filter (S/N 522311001 & Above) ...	10-80-2
HYDRAULIC SYSTEM	10-100-1
Checking And Adding Hydraulic Oil	10-100-1
Diagnostic Couplers (S/N 522311001 & Above)	10-100-9
Diagnostic Couplers (S/N 528911001 & Above And S/N 528611001 & Above) 10-100-10	
Hydraulic Filter Installation (S/N 522311001 & Above)	10-100-4
Hydraulic Filter Installation (S/N 528911001 & Above And S/N 528611001 & Above)	10-100-7
Hydraulic Filter Removal (S/N 522311001 & Above)	10-100-3
Hydraulic Filter Removal (S/N 528911001 & Above And S/N 528611001 & Above)	10-100-6
Replacing The Hydraulic Oil	10-100-2
LIFTING AND BLOCKING THE EXCAVATOR	10-10-1
Procedure	10-10-1
LIFTING THE EXCAVATOR	1
Procedure	10-11-1
LUBRICATION OF THE EXCAVATOR	10-110-1
OPERATOR CAB	10-20-1
Description	10-20-1
Emergency Exit	10-20-2
Entering And Exiting The Excavator	10-20-1
Raising And Lowering The Left Console	10-20-1
REAR COVER	10-40-1
Opening And Closing The Rear Cover	10-40-1
RIGHT SIDE COVER	10-41-1
Opening And Closing The Right Side Cover	10-41-1

Continued On Next Page

SAFETY AND MAINTENANCE (CONT'D)

SERVICE SCHEDULE	10-50-1
TRANSPORTING THE EXCAVATOR	10-30-1
TRAVEL MOTOR	10-120-1
Checking Oil Level	10-120-1
Draining The Travel Motor	10-120-1

LIFTING AND BLOCKING THE EXCAVATOR

Procedure

Always park the machine on a level surface.



Put jackstands under the blade and rear corners of the undercarriage before working under the machine. Failure to block up the machine may allow it to move or fall and result in injury or death.

W-2218-1195



AVOID INJURY OR DEATH

Keep fingers and hands out of pinch points when checking the track tension.

W-2142-0189

Raise one side of the machine (approximately 4 inches) using the boom and arm.

Figure 10-10-1

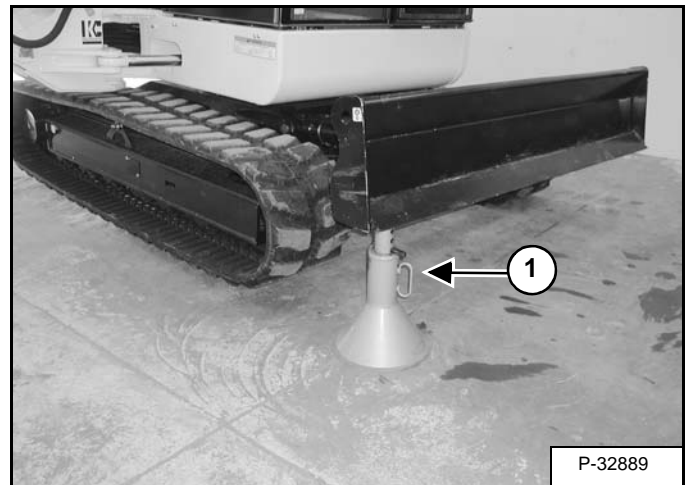
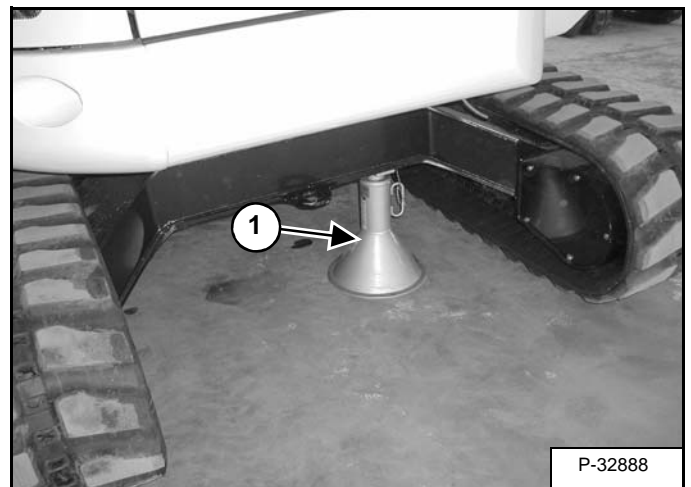

Figure 10-10-2



Raise the blade fully and install jackstands (Item 1) [Figure 10-10-1] & [Figure 10-10-2] under the blade and the track frame. Lower the machine until all machine weight is on the jackstands.

Stop the engine.

LIFTING THE EXCAVATOR

Procedure

WARNING

AVOID INJURY OR DEATH

- Use a lifting fixture with sufficient capacity for the weight of the excavator plus any added attachments.
- Maintain center of gravity and balance when lifting.
- Do not swing boom or upperstructure.
- Never lift with operator on machine.

W-2434-0502

Figure 10-11-1

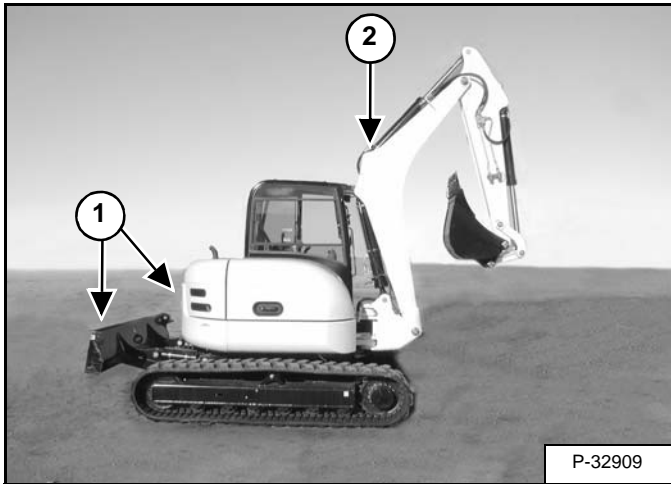

Fully retract the boom cylinder and fully extend the arm and bucket cylinders so the excavator is in the position as shown [Figure 10-11-1].

Raise the blade all the way.

Put all the control levers in neutral.

Stop the engine.

Figure 10-11-2

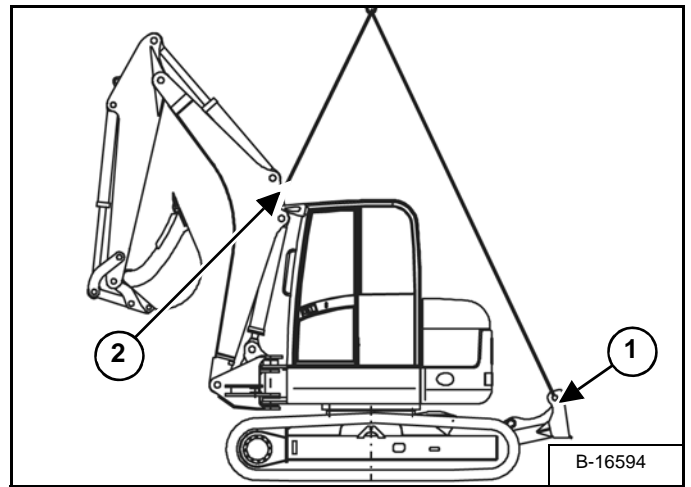

Fasten chains to the ends of the blade (Item 1) [Figure 10-11-1] & [Figure 10-11-2] and up to a lifting fixture above the cab. The lifting fixture must extend over the sides of the cab to prevent the chains from hitting the cab [Figure 10-11-2].

Fasten a chain to the boom (Item 2) [Figure 10-11-1] & [Figure 10-11-2] and up to a lifting fixture.

OPERATOR CAB

Description

The excavator has an operator cab as standard equipment.



Never modify operator cab by welding, grinding, drilling holes or adding attachments unless instructed to do so by Bobcat.

W-2069-1299

Entering And Exiting The Excavator

Figure 10-20-1



Use the grab handles and track to enter and exit the excavator [Figure 10-20-1].

Raising And Lowering The Left Console

Raise the console before exiting the cab.

Figure 10-20-2



Pull up on the handle (Item 1) [Figure 10-20-2] The lift spring will assist in raising the console.

Lower the console before operating the excavator.

Push down on the handle (Item 1) [Figure 10-20-2] until the console is in the down position.

NOTE: When the console is raised, the hydraulic and traction systems are locked and will not operate.

OPERATOR CAB (CONT'D)

Emergency Exit

The left door and right side window provide exits.

Figure 10-20-3

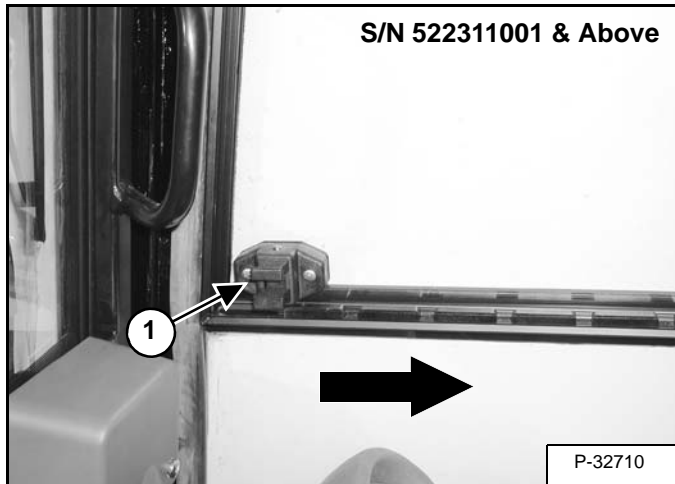
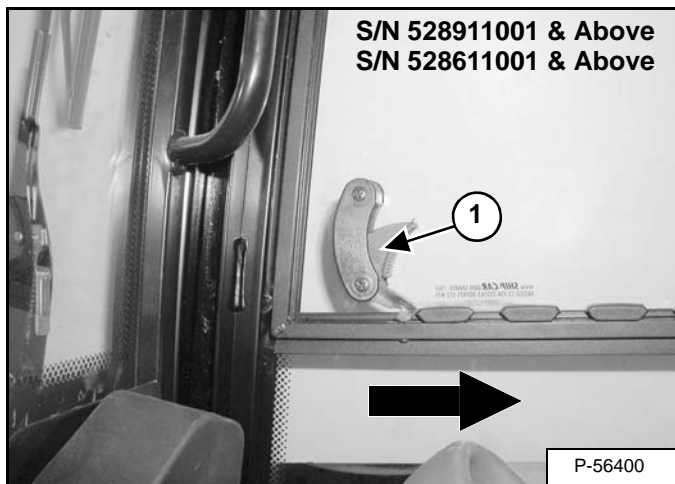

Figure 10-20-4



Press the window latch (Item 1) [Figure 10-20-3] & [Figure 10-20-4] together and slide the window to the rear of the excavator.

Figure 10-20-5



Exit through the window [Figure 10-20-5].

TRANSPORTING THE EXCAVATOR

When transporting the machine, observe the rules, motor vehicle laws and vehicle limit ordinances. Use a transport and towing vehicle of adequate length and capacity.

Secure the parking brakes and block the wheels of the transport vehicle.

Align the ramps with the center of the transport vehicle. Secure the ramps to the truck bed and be sure ramp angle does not exceed 15 degrees.

Use metal loading ramps with a slip resistant surface.

Use ramps that are the correct length and width, and can support the weight of the machine.

The rear of the trailer must be blocked or supported when loading or unloading the excavator to prevent the front of the transport vehicle from raising.

Determine the direction of the track movement before moving the machine (blade forward).

Figure 10-30-1



Move the machine forward onto the transport vehicle **[Figure 10-30-1]**.

Do not change direction of the machine while it is on the ramps.

Lower the boom, arm and bucket to the transport vehicle.

Stop the engine and remove the key.

Put blocks at the front and rear of the tracks.

Figure 10-30-2

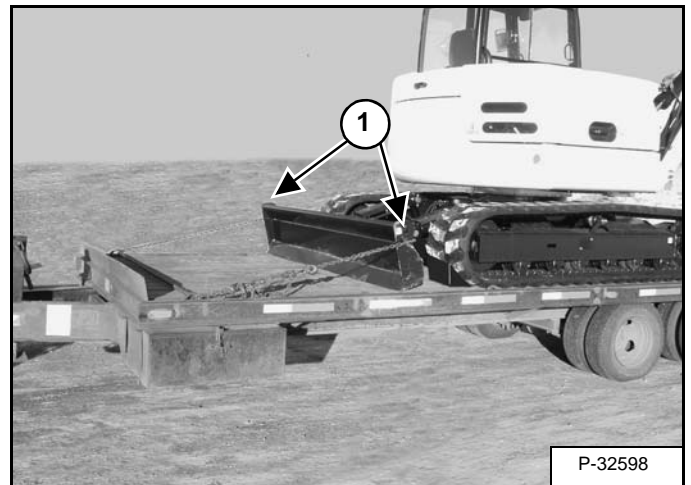

Figure 10-30-3



Fasten chains to the front corners of the blade (Item 1) **[Figure 10-30-2]** and to the tie down loop at the rear track frame (both sides) (Item 1) **[Figure 10-30-3]** to prevent it from moving when going up or down slopes, or during sudden stops.

Use chain binders to tighten the chains and then safely tie the chain binder levers to prevent loosening.

! WARNING

Adequately designed ramps of sufficient strength are needed to support the weight of the machine when loading onto a transport vehicle. Wood ramps can break and cause personal injury.

W-2058-0494

REAR COVER

Opening And Closing The Rear Cover

WARNING

AVOID INJURY OR DEATH

Never service or adjust the machine when the engine is running unless instructed to do so in the manual.

W-2012-0497

WARNING

Keep the rear door closed when operating the machine. Failure to do so could seriously injure a bystander.

W-2020-1285

Figure 10-40-1

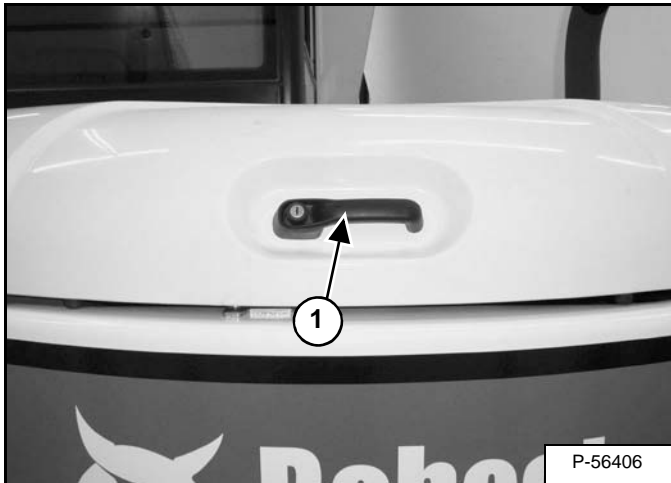

Push the latch (Item 1) [Figure 10-40-1] and raise the rear cover.

Lower the rear cover and push down firmly to close the cover.

NOTE: The start key can be used to lock the rear cover.

RIGHT SIDE COVER

Opening And Closing The Right Side Cover

Figure 10-41-2

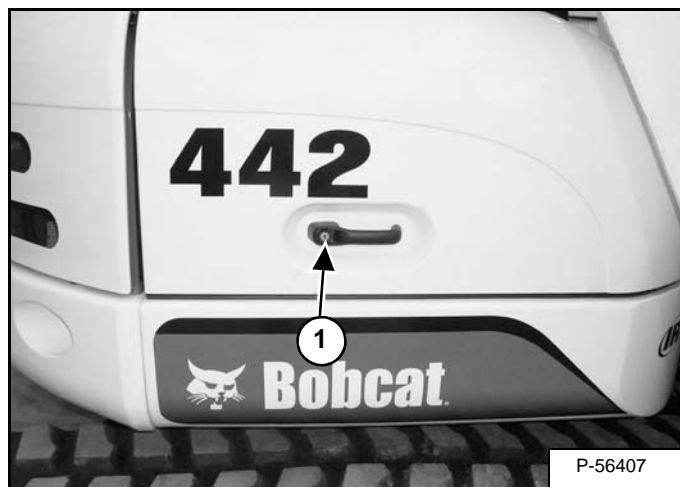

Push the latch (Item 1) [Figure 10-41-2] and raise the right side cover.

Lower the right side cover and push down firmly to close the cover.

NOTE: The start key can be used to lock the right side cover.

SERVICE SCHEDULE

Maintenance work must be done at regular intervals. Failure to do so will result in excessive wear and early failures. The service schedule is a guide for correct maintenance of the Bobcat Excavator.

SERVICE SCHEDULE		HOURS					
ITEM	SERVICE REQUIRED	8-10	50	100	250	500	1000
Engine Coolant	Check coolant level. Add coolant as needed. (Water cooled engines only)						
Engine Oil	Check engine oil level and add as needed.						
Hydraulic Fluid Hoses Tube lines and Reservoir Breather Cap	Check the hydraulic fluid level and add as needed. Check for damage and leaks. Repair or replaced as needed.						
Track Tension	Check and adjust track tension.						
Indicators and Lights	Check for correct operation of indicators and lights.						
Operator Cab/Canopy	Check cab/canopy condition and hardware.						
Seat Belt	Check seat belt condition and mounting hardware						
Safety Signs (Decals)	Check for damaged signs (decals). Replace as needed.						
Pivot Points	Grease all machinery pivot points.						
Fuel Tank & Filter	Drain water and sediment from fuel tank and filter.						
Control Console	Check control console lockout for proper operation.						
Swing Circle & Pinion	Grease swing circle and swing pinion.						
Door Hinges	Grease door hinges.						
Battery	Check battery, cables and electrolyte level.						
Belts	Check and adjust bolts.	■					
Travel Motors	Check oil level in both travel motors.						
Hydraulic Oil Cooler, *Engine Oil Cooler, *Radiator, A/C Condenser and Cab Ventilation Filter	Clean radiator/oil cooler fins. Clean A/C condenser. Clean/replace cab filter.			◆			
Hydraulic Filter	Replace hydraulic filter.			◆			
Engine Oil & Filter	Replace engine oil and filter.			◆			
Air Filter Intake	Check/clean air filter intake						
Alternator & Starter	Check alternator and starter connections.						
Fuel Filters	Replace diesel fuel pre-filter and filter.						
Engine Valves	Check and adjust engine valve clearance.						
Travel Motors	Replace oil in both travel motors.			◆			
Engine Cooling System	Drain and flush cooling system. Replace coolant. (Water cooled engines only)						
Hydraulic System	Replace hydraulic fluid and filter. Clean reservoir.						

* If equipped

- Service at first 50 hours, then as scheduled
- ◆ Service at first 100 hours, then as scheduled
- 1000 hours or every six months

AIR CLEANER

Daily Check

See the Service Schedule for the correct service interval. (See SERVICE SCHEDULE on Page 10-50-1.)

Figure 10-60-1

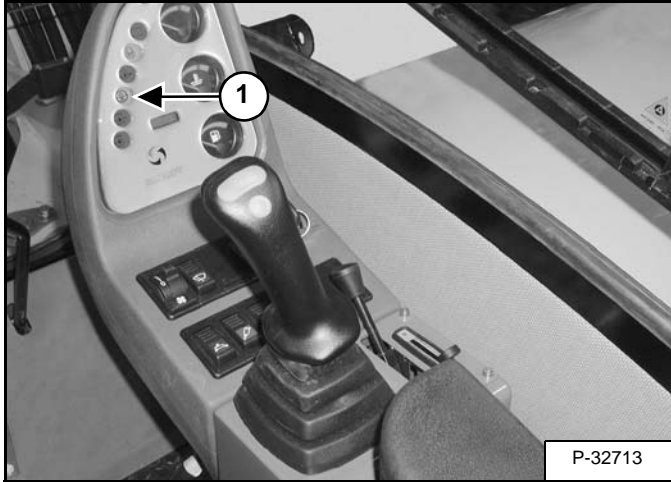

If the air filter condition indicator (Item 1) [Figure 10-60-1] is illuminated, the filter element needs to be replaced.

Open the right side cover. (See RIGHT SIDE COVER on Page 10-41-1.)

Figure 10-60-2

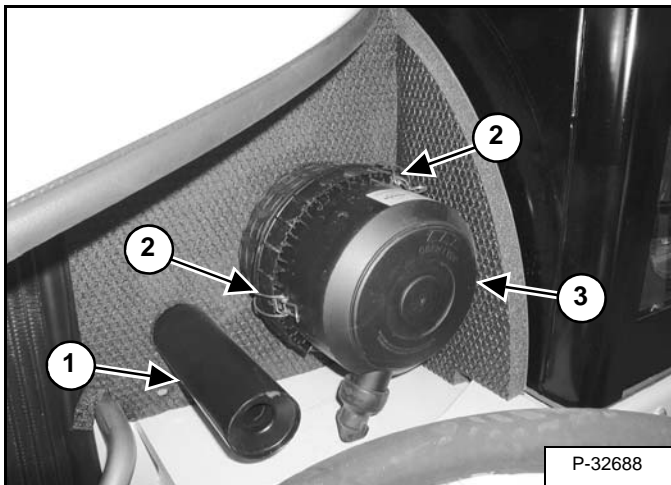

Inspect the air intake (Item 1) [Figure 10-60-2] for damage or restrictions.

Replacing The Filters

Outer Filter

Unlatch the air filter cover latches (Item 2) [Figure 10-60-2].

Remove the air filter cover (Item 3) [Figure 10-60-2].

Figure 10-60-3

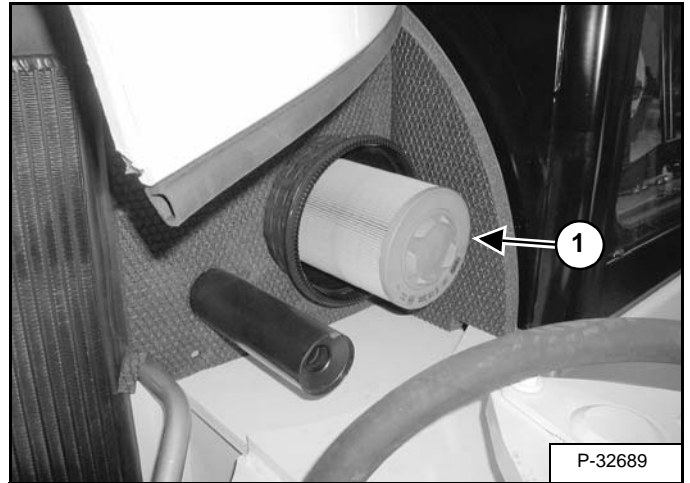

Remove the outer filter (Item 1) [Figure 10-60-3].

Check the housing for damage.

Clean the housing and seal surface. Do not use compressed air.

Install the outer filter.

Install the cover.

AIR CLEANER (CONT'D)

Replacing The Filters (Cont'd)

Inner Filter S/N 522311001 & Above

Replace the inner filter every third time the outer filter has been replaced.

Replace the inner filter after the outer filter has been replaced and the air filter indicator is still illuminated.

Remove the air cleaner cover and outer filter.

Figure 10-60-4

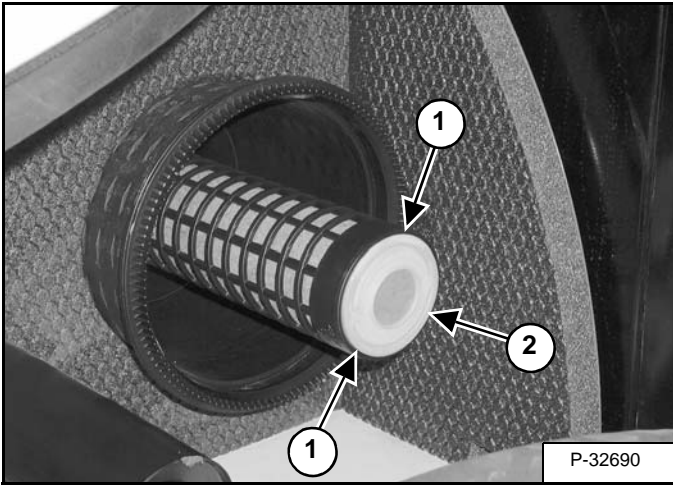

Pry up on the ends of the air filter (Item 1). Pull the air filter (Item 2) [Figure 10-60-4] out of the housing.

Discard the inner air filter after it has been removed.

Do not clean or reuse the filter. Make sure all sealing surfaces are free of dirt and debris.

Figure 10-60-5

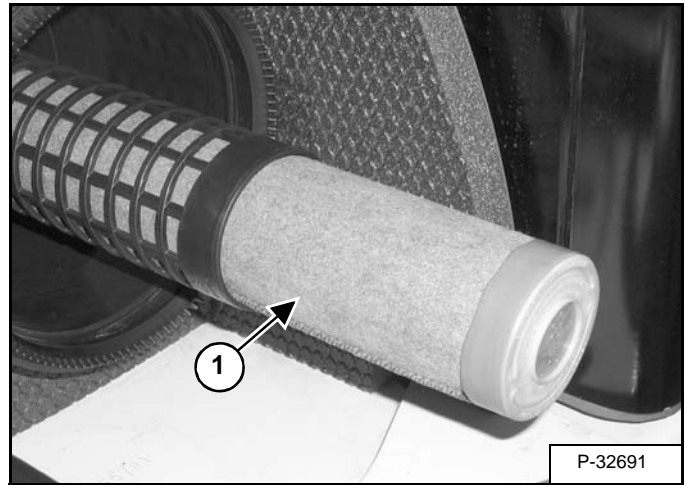

Install the new inner filter (Item 1) [Figure 10-60-5]. Install the outer filter and air cleaner cover.

AIR CLEANER (CONT'D)

Replacing The Filters (Cont'd)

Inner Filter S/N 528911001 & Above and S/N 528611001 & Above

Replace the inner filter every third time the outer filter has been replaced.

Replace the inner filter after the outer filter has been replaced and the air filter indicator is still illuminated.

Remove the air cleaner cover and outer filter.

Figure 10-60-6

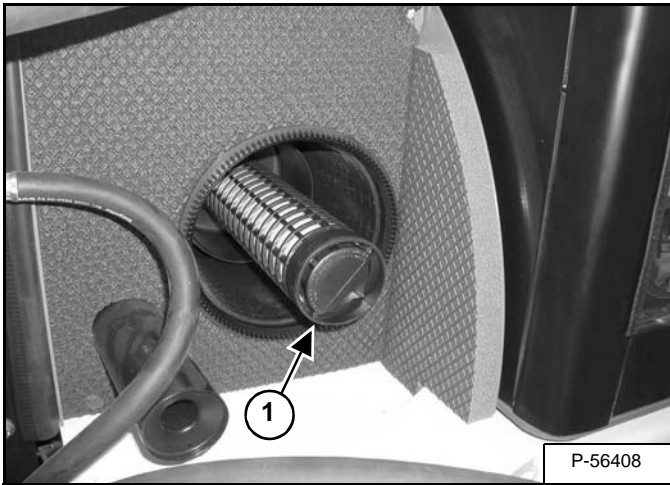

Pull the air filter (Item 1) **[Figure 10-60-6]** out of the housing.

Discard the inner air filter after it has been removed.

Do not clean or reuse the filter. Make sure all sealing surfaces are free of dirt and debris.

Figure 10-60-7

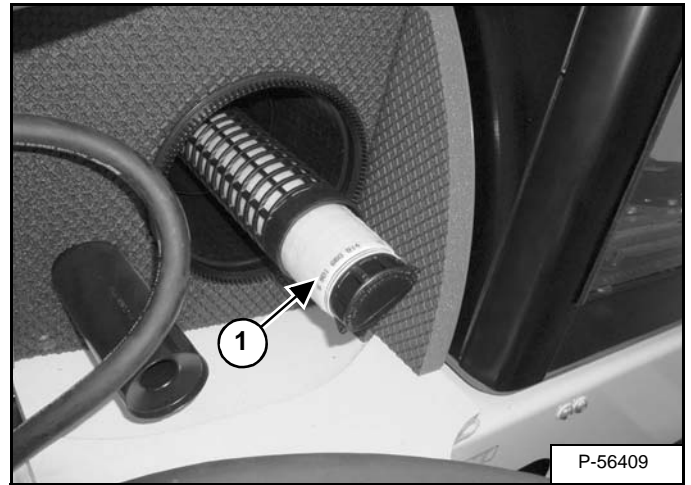

Install the new inner filter (Item 1) **[Figure 10-60-7]**. Install the outer filter and air cleaner cover.



Suggest:

If the above button click is invalid.

Please download this document

first, and then click the above link

to download the complete manual.

Thank you so much for reading

FRESH AIR FILTER (S/N 522311001 & ABOVE)

Removal And Installation

See the Service Schedule for the correct service interval.
(See SERVICE SCHEDULE on Page 10-50-1.)

Figure 10-61-1

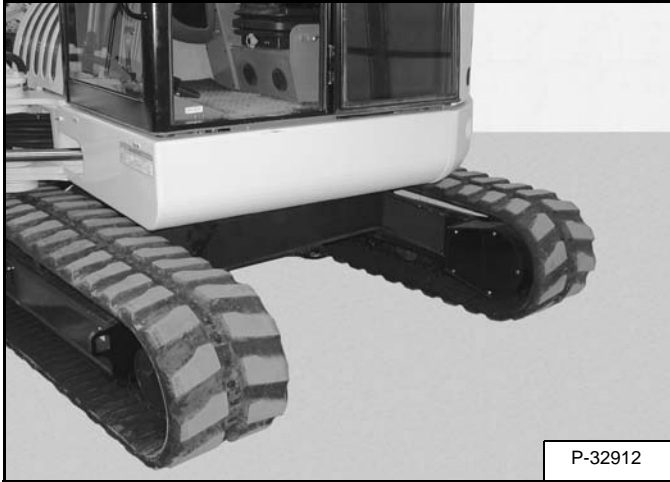

Position the excavator as shown [Figure 10-61-1].

Figure 10-61-2

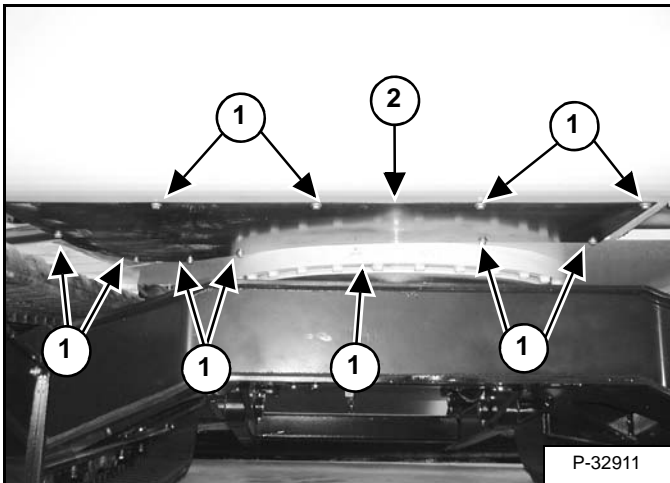

Remove the eleven bolts (Item 1) [Figure 10-61-2] and washers.

Installation: Tighten the bolts to 18-19 ft.-lb. (24-26 N•m) torque.

Remove the cover (Item 2) [Figure 10-61-2].

Figure 10-61-3

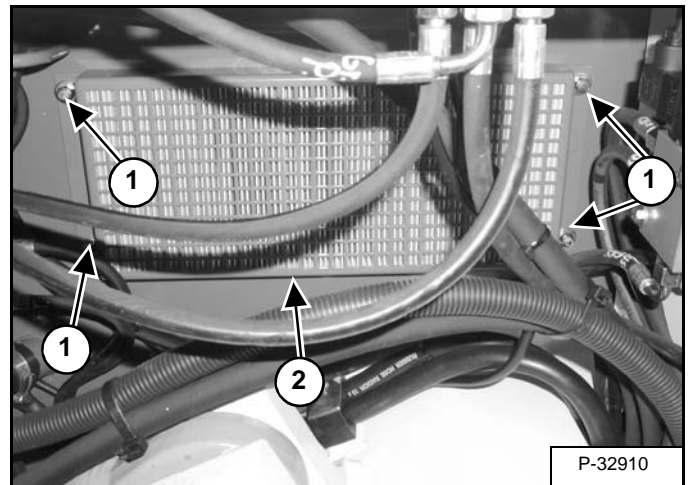

Remove the bolts (Item 1) [Figure 10-61-3].

Remove the filter (Item 2) [Figure 10-61-3].

<https://www.ebooklibonline.com>

Hello dear friend!

Thank you very much for reading.

Enter the link into your browser.

The full manual is available for immediate download.

<https://www.ebooklibonline.com>