

435



Bobcat®

Service Manual

**S/N 562611001 & Above
S/N 562811001 & Above
S/N 563111001 & Above
S/N 563211001 & Above**

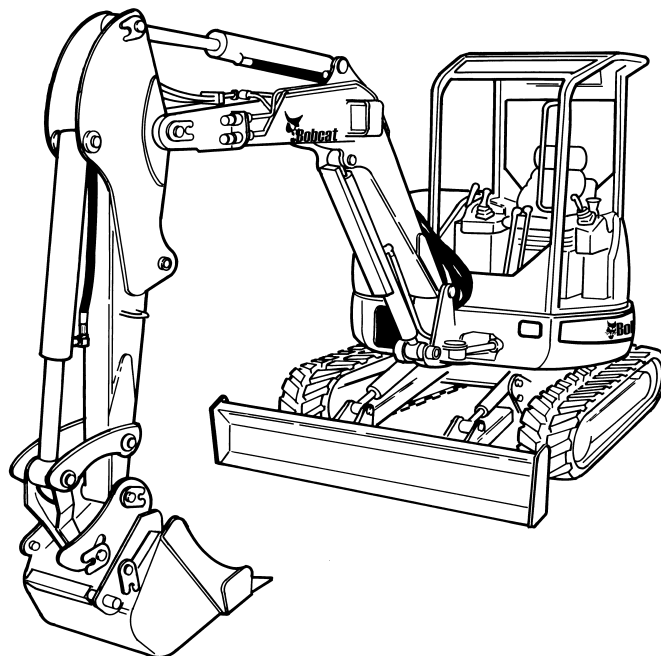

MAINTENANCE SAFETY



WARNING

Instructions are necessary before operating or servicing machine. Read and understand the Operation & Maintenance Manual, Operator's Handbook and signs (decals) on machine. Follow warnings and instructions in the manuals when making repairs, adjustments or servicing. Check for correct function after adjustments, repairs or service. Untrained operators and failure to follow instructions can cause injury or death.

W-2003-0903



Safety Alert Symbol: This symbol with a warning statement, means: "Warning, be alert! Your safety is involved!" Carefully read the message that follows.

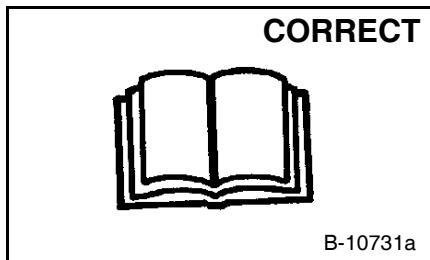

B-10731a

- ⚠ Never service the Bobcat Hydraulic Excavator without instructions.

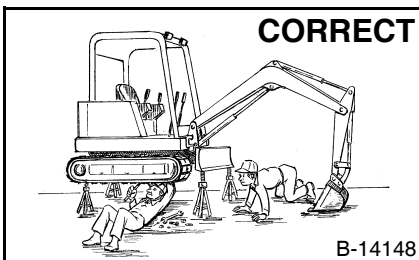

B-14148

- ⚠ Use the correct procedure to lift and support the excavator.
- ⚠ Always lift the blade fully before installing jackstands.

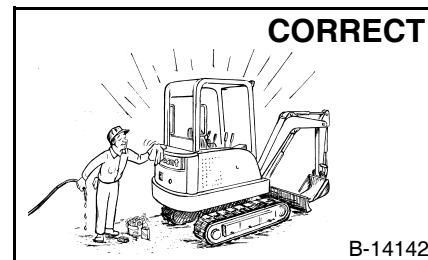

B-14142

- ⚠ Cleaning and maintenance are required daily.

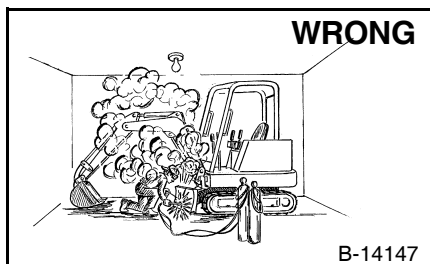

B-14147

- ⚠ Have good ventilation when welding or grinding painted parts.
- ⚠ Wear dust mask when grinding painted parts. Toxic dust and gas can be produced.

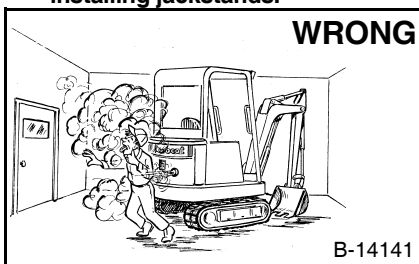

B-14141

- ⚠ Vent exhaust to outside when engine must be run for service.
- ⚠ Exhaust system must be tightly sealed. Exhaust Fumes can kill without warning.

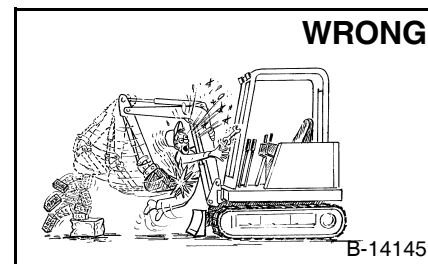

B-14145

- ⚠ Always lower the bucket and blade to the ground before doing any maintenance.
- ⚠ Never modify equipment or add attachments not approved by Bobcat Company.

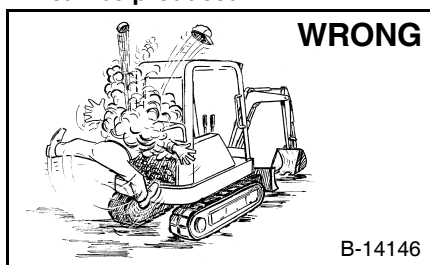

B-14146

- ⚠ Stop, cool and clean engine of flammable materials before checking fluids.
- ⚠ Never service or adjust machine with the engine running unless instructed to do so in the manual.
- ⚠ Avoid contact with leaking hydraulic fluid or diesel fuel under pressure. It can penetrate the skin or eyes.
- ⚠ Never fill fuel tank with engine running, while smoking or when near open flame.

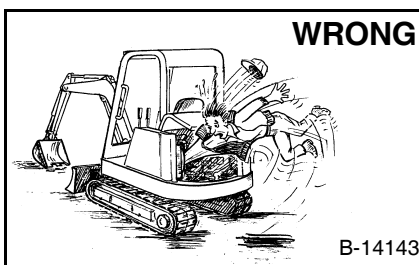

B-14143

- ⚠ Keep body, jewelry and clothing away from moving parts, electrical contact, hot parts and exhaust.
- ⚠ Wear eye protection to guard from battery acid, compressed springs, fluids under pressure and flying debris when engines are running or tools are used. Use eye protection approved for type of welding.
- ⚠ Keep rear door closed except for service. Close and latch door before operating the excavator.



B-6589

- ⚠ Lead-acid batteries produce flammable and explosive gases.
- ⚠ Keep arcs, sparks, flames and lighted tobacco away from batteries.
- ⚠ Batteries contain acid which burns eyes or skin on contact. Wear protective clothing. If acid contacts body, flush well with water. For eye contact flush well and get immediate medical attention.

Maintenance procedures which are given in the Operation & Maintenance Manual can be performed by the owner/operator without any specific technical training. Maintenance procedures which are **not** in the Operation & Maintenance Manual must be performed **ONLY BY QUALIFIED BOBCAT SERVICE PERSONNEL**. Always use genuine Bobcat replacement parts. The Service Safety Training Course is available from your Bobcat dealer.

ALPHABETICAL INDEX

AIR CLEANER	10-01, 70-01	FLOORMAT AND FLOOR PLATES	50-01
AIR CONDITIONING SERVICE	80-01	FUEL, COOLANT AND LUBRICANTS	SPEC-01
AIR CONDITIONING SYSTEM FLOW	80-01	FUEL LEVEL SENDER	60-01
ALTERNATOR	60-01	FUEL SYSTEM.....	10-01
ARM	50-01	FUEL TANK	50-01
ARM CYLINDER	20-01		
		GENERAL AIR CONDITIONING SERVICE GUIDELINES	
BASIC TROUBLESHOOTING	80-01	80-01
BATTERY	60-01		
BLADE	40-01	HEATER A/C FAN	80-01
BLADE CONTROL.....	50-01	HEATER AIR FILTER (WITH CAB OPTION ONLY)	
BLADE CYLINDER	20-01	10-01
BOOM	50-01	HEATER COIL	80-01
BOOM CYLINDER.....	20-01	HEATER VALVE	80-01
BOOM SWING CYLINDER.....	20-01	HOSES	20-01
BOOM SWING LOCK VALVE	20-01	HORN	50-01
BUCKET	50-01	HYDRAULIC CONTROL VALVE	20-01
BUCKET CYLINDER	20-01	HYDRAULIC CONNECTION SPECS	SPEC-01
BUILD UP VALVE	20-01	HYDRAULIC FLUID SPECIFICATIONS.....	SPEC-01
		HYDRAULIC FILTER MOUNT.....	20-01
CAB.....	50-01	HYDRAULIC PUMP	20-01
CLAMP CYLINDER	20-01	HYDRAULIC RESERVOIR.....	20-01
COMPONENTS	80-01	HYDRAULIC SYSTEM.....	10-01
COMPRESSOR	80-01	HYDRAULIC SYSTEM INFORMATION	20-01
CONDENSOR	80-01	HYDRAULIC X-CHANGE VALVE.....	50-01
CONVERSIONS	SPEC-01	HYDROSTATIC PUMP.....	30-01
CONTROL LINKAGE ASSEMBLY.....	50-01	HYDRAULIC PUMP START UP	30-01
CONTROL PATTERN SELECTOR VALVE	20-01	HYDROSTATIC SYSTEM INFORMATION.....	30-01
COOLING FAN	20-01		
COOLING SYSTEM.....	10-01	LEFT CONTROL LEVER (JOYSTICK)	20-01
CROSSPORT RELIEF VALVE	20-01	LEFT CONSOLE	50-01
		LIFTING AND BLOCKING THE EXCAVATOR	10-01
DELUXE INSTRUMENT PANEL SETUP.....	60-01	LIFTING THE EXCAVATOR	10-01
DIAGNOSTICS SERVICE CODE	60-01	LIGHTS.....	60-01
DIRECT TO TANK VALVE	20-01	LOWER TRACK ROLLER.....	40-01
DRIVE BELT	30-01	LUBRICATION OF THE HYDRAULIC EXCAVATOR	
DRIVE BELT SHIELD	30-01	10-01
DUAL SEQUENCE VALVE	20-01		
		MAIN RELIEF VALVES.....	20-01
ELECTRICAL SYSTEM INFORMATION	60-01	MANIFOLD ASSEMBLY/ACCUMULATOR	20-01
ENGINE	70-01	MUFFLER.....	70-01
ENGINE ACCESSORY DRIVE BELT	10-01		
ENGINE COMPONENTS AND TESTING	70-01	OIL COOLER.....	20-01
ENGINE FLYWHEEL	70-01	OPERATOR CAB (ROPS/TOPS)	10-01
ENGINE LUBRICATION SYSTEM.....	10-01		
ENGINE SPECIFICATIONS.....	SPEC-01	PORT RELIEF VALVES.....	20-01
ENGINE SPEED CONTROL	50-01	PRESSURE REDUCING VALVE.....	20-01
EVAPORATOR.....	80-01	PRESSURE RELIEF VALVE	80-01
EVAPORATOR/HEATER UNIT	80-01	PRESSURE SWITCH	80-01
EXPANSION VALVE	80-01		
FAN/CHARGE PUMP	30-01		

Continued On Next Page

<https://www.ebooklibonline.com>

Hello dear friend!

Thank you very much for reading.

Enter the link into your browser.

The full manual is available for immediate download.

<https://www.ebooklibonline.com>

ALPHABETICAL INDEX (CONT'D)

RADIATOR	70-01
RECEIVER/DRIER	80-01
RECONDITIONING THE ENGINE	70-01
REGULAR MAINTENANCE	80-01
REMOVING AIR FROM HYDRAULIC SYSTEM	20-01
RIGHT CONTROL LEVER (JOYSTICK)	20-01
RIGHT CONSOLE	50-01
RIGHT PEDAL AND LINKAGE.....	50-01
RIGHT SIDE COVER	10-01, 50-01
ROPS CANOPY.....	50-01
SAFETY	80-01
SEAT AND SEAT MOUNT.....	50-01
SERVICE SCHEDULE	10-01
SPARK ARRESTOR MUFFLER.....	10-01
SPECIFICATIONS	SPEC-01
STARTER	60-01
SWING CIRCLE GEAR	40-01
SWING FRAME	50-01
SWING MOTOR	20-01
SWING MOTOR DRIVE CARRIER	20-01
SWIVEL JOINT.....	20-01
SYSTEM CHARGING AND RECLAMATION	80-01
SYSTEM TROUBLESHOOTING CHART	80-01
TAILGATE	10-01, 50-01
TEMPERATURE/PRESSURE	80-01
THERMOSTAT.....	80-01
TORQUE SPECIFICATIONS	SPEC-01
TRACK DAMAGE IDENTIFICATION.....	40-01
TRACK FRAME	40-01
TRACK IDLER	40-01
TRACKS	40-01
TRANSPORTING THE EXCAVATOR.....	10-01
TRAVEL CONTROL VALVE	20-01
TRAVEL CONTROLS	50-01
TRAVEL MOTOR.....	10-01, 20-01
TRAVEL PILOT PRESSURE.....	30-01
TROUBLESHOOTING.....	70-01
TWO SPEED SWITCH	60-01
UPPERSTRUCTURE	50-01
UPPERSTRUCTURE SLEW LOCK	10-01
UPPER TRACK ROLLER.....	40-01
X-CHANGE	50-01
X-CHANGE (HYDRAULIC).....	50-01
X-CHANGE (PIN ON)	50-01

CONTENTS

FOREWORD.....	III
SAFETY INSTRUCTIONS.....	V
SERIAL NUMBER LOCATIONS	IX
DELIVERY REPORT.....	X
BOBCAT EXCAVATOR IDENTIFICATION	XI
SAFETY AND MAINTENANCE.....	10-01
HYDRAULIC SYSTEM	20-01
HYDROSTATIC SYSTEM.....	30-01
UNDERCARRIAGE.....	40-01
UPPERSTRUCTURE & SWING SECTION	50-01
ELECTRICAL SYSTEM AND ANALYSIS	60-01
ENGINE SERVICE	70-01
HEATING, VENTILATION, AIR CONDITIONING	80-01
SPECIFICATIONS.....	SPEC-01

**SAFETY AND
MAINTENANCE**

**HYDRAULIC
SYSTEM**

**HYDROSTATIC
SYSTEM**

UNDERCARRIAGE

**UPPERSTRUCTURE
& SWING
SECTION**

**ELECTRICAL
SYSTEM AND
ANALYSIS**

**ENGINE
SERVICE**

HVAC

SPECIFICATIONS

FOREWORD

This manual is for the Bobcat Excavator mechanic. It provides necessary servicing and adjustment procedures for the excavator and its component parts and systems. Refer to the Operation & Maintenance Manual for operating instructions, starting procedure, daily checks, etc.

A general inspection of the following items must be made after the excavator has had service or repair:

1. Check that the ROPS/TOPS/FOPS is in good condition and is NOT modified.

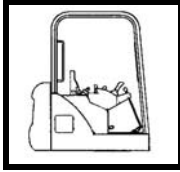

2. Check that ROPS/TOPS mounting hardware is tightened and is Bobcat approved.

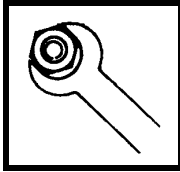

3. The seat belt must be correctly installed, functional and in good condition.

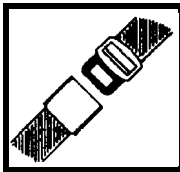

4. Inspect for loose or broken parts or connections.

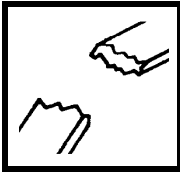

5. Machine signs must be legible and in the correct location.



6. Steering levers, control levers and foot pedals must return to neutral. Check that foot pedals lock and control lever locks are in working order.

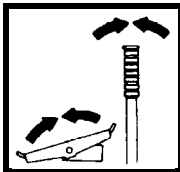

7. Inspect the air cleaner for damage or leaks. Check the condition of the filters.

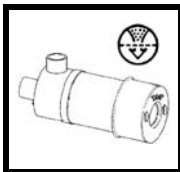

8. Check the electrical charging system.

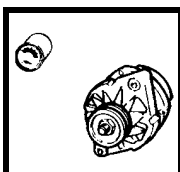

9. Safety treads must be in good condition.

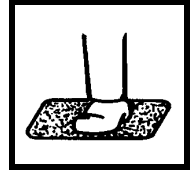

10. Check for correct function of indicator lamps (Optional on some models).

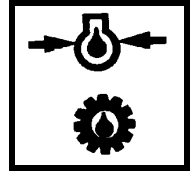

11. Check hydraulic fluid level, engine oil level and fuel supply.

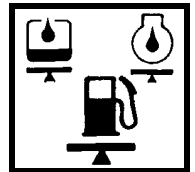

12. Inspect for fuel, oil or hydraulic fluid leaks.

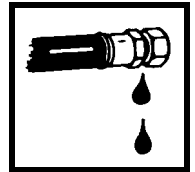

13. Lubricate the excavator.

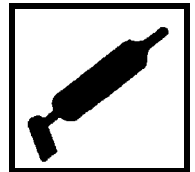

14. Check the condition of the battery and cables.

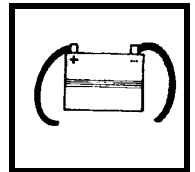

Recommend to the owner that all necessary corrections be made before the excavator is returned to service.

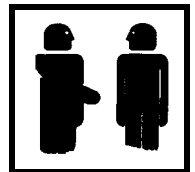

**CALIFORNIA
PROPOSITION 65 WARNING**
Diesel engine exhaust and some of its constituents are known to the state of California to cause cancer, birth defects and other reproductive harm.

SAFETY INSTRUCTIONS



Safety Alert Symbol

This symbol with a warning statement means: "Warning, be alert! Your safety is involved!" Carefully read the message that follows.



WARNING

Instructions are necessary before operating or servicing machine. Read and understand the Operation & Maintenance Manual, Operator's Handbook and signs (decals) on machine. Follow warnings and instructions in the manuals when making repairs, adjustments or servicing. Check for correct function after adjustments, repairs or service. Untrained operators and failure to follow instructions can cause injury or death.

W-2003-0903

IMPORTANT

This notice identifies procedures which must be followed to avoid damage to the machine.

I-2019-0284



DANGER

The signal word DANGER on the machine and in the manuals indicates a hazardous situation which, if not avoided, will result in death or serious injury.

D-1002-1107



WARNING

The signal word WARNING on the machine and in the manuals indicates a potentially hazardous situation which, if not avoided, could result in death or serious injury.

W-2044-1107

The following publications provide information on the safe use and maintenance of the Bobcat machine and attachments:

- The Delivery Report is used to assure that complete instructions have been given to the new owner and that the machine is in safe operating condition.
- The Operation & Maintenance Manual delivered with the machine or attachment contains operating information as well as routine maintenance and service procedures. It is a part of the machine and can be stored in a container provided on the machine. Replacement Operation & Maintenance Manuals can be ordered from your Bobcat dealer.
- Machine signs (decals) instruct on the safe operation and care of your Bobcat machine or attachment. The signs and their locations are shown in the Operation & Maintenance Manual. Replacement signs are available from your Bobcat dealer.
- An Operator's Handbook fastened to the operator cab. It's brief instructions are convenient to the operator. The handbook is available from your dealer in an English edition or one of many other languages. See your Bobcat dealer for more information on translated versions.
- The AEM Safety Manual delivered with the machine gives general safety information.
- The Service Manual and Parts Manual are available from your dealer for use by mechanics to do shop-type service and repair work.
- The Compact Excavator Operator Training Course is available through your local dealer or at www.training.bobcat.com or www.bobcat.com. This course is intended to provide rules and practices of correct operation of the Bobcat excavator. The course is available in English and Spanish versions.
- Service Safety Training Courses are available from your Bobcat dealer or at www.training.bobcat.com or www.bobcat.com. They provide information for safe and correct service procedures.
- The Bobcat compact excavator Safety Video is available from your Bobcat dealer or at www.training.bobcat.com or www.bobcat.com.

SI EXC-0308 SM

435 Excavator
Service Manual

FIRE PREVENTION



Maintenance

The machine and some attachments have components that are at high temperatures under normal operating conditions. The primary source of high temperatures is the engine and exhaust system. The electrical system, if damaged or incorrectly maintained, can be a source of arcs or sparks.

Flammable debris (leaves, straw, etc.) must be removed regularly. If flammable debris is allowed to accumulate, it can cause a fire hazard. Clean often to avoid this accumulation. Flammable debris in the engine compartment is a potential fire hazard.

The operator's area, engine compartment and engine cooling system must be inspected every day and cleaned if necessary to prevent fire hazards and overheating.

All fuels, most lubricants and some coolants mixtures are flammable. Flammable fluids that are leaking or spilled onto hot surfaces or onto electrical components can cause a fire.

Operation

Do not use the machine where exhaust, arcs, sparks or hot components can contact flammable material, explosive dust or gases.

Electrical



Check all electrical wiring and connections for damage. Keep the battery terminals clean and tight. Repair or replace any damaged part or wires that are loose or frayed.

Battery gas can explode and cause serious injury. Use the procedure in the Operation & Maintenance Manual for connecting the battery and for jump starting. Do not jump start or charge a frozen or damaged battery. Keep any open flames or sparks away from batteries. Do not smoke in battery charging area.

Hydraulic System

Check hydraulic tubes, hoses and fittings for damage and leakage. Never use open flame or bare skin to check for leaks. Hydraulic tubes and hoses must be properly routed and have adequate support and secure clamps. Tighten or replace any parts that show leakage.

Always clean fluid spills. Do not use gasoline or diesel fuel for cleaning parts. Use commercial nonflammable solvents.

Fueling



Stop the engine and let it cool before adding fuel. No smoking! Do not refuel a machine near open flames or sparks. Fill the fuel tank outdoors.

Starting

Do not use ether or starting fluids on any engine that has glow plugs. These starting aids can cause explosion and injure you or bystanders.

Use the procedure in the Operation & Maintenance Manual for connecting the battery and for jump starting.

Spark Arrestor Exhaust System

The spark arrestor exhaust system is designed to control the emission of hot particles from the engine and exhaust system, but the muffler and the exhaust gases are still hot.

Check the spark arrestor exhaust system regularly to make sure it is maintained and working properly. Use the procedure in the Operation & Maintenance Manual for cleaning the spark arrestor muffler (if equipped).

FIRE PREVENTION (CONT'D)

Welding And Grinding

Always clean the machine and attachment, disconnect the battery, and disconnect the wiring from the Bobcat controllers before welding. Cover rubber hoses, battery and all other flammable parts. Keep a fire extinguisher near the machine when welding.

Have good ventilation when grinding or welding painted parts. Wear dust mask when grinding painted parts. Toxic dust or gas can be produced.

Dust generated from repairing nonmetallic parts such as hoods, fenders or covers can be flammable or explosive. Repair such components in a well ventilated area away from open flames or sparks.

Fire Extinguishers

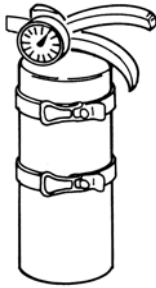

Know where fire extinguishers and first aid kits are located and how to use them. Inspect the fire extinguisher and service the fire extinguisher regularly. Obey the recommendations on the instructions plate.

SERIAL NUMBER LOCATIONS

Always use the serial number of the excavator when requesting service information or when ordering parts. Early or later models (identification made by serial number) may use different parts, or it may be necessary to use a different procedure in doing a specific service operation.

Excavator Serial Number

Figure 1

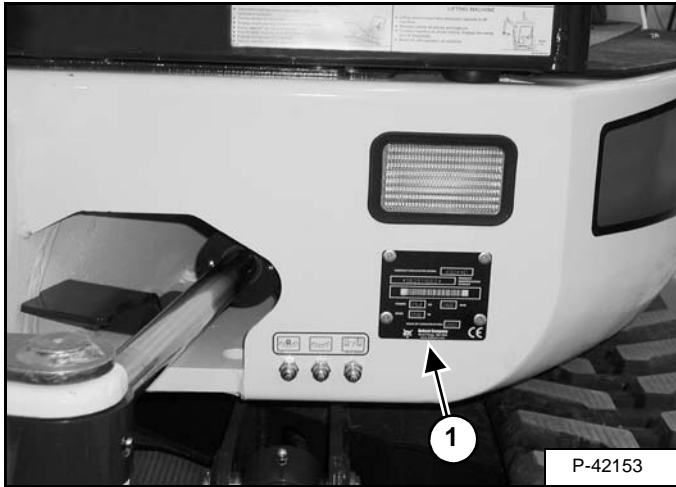

The excavator serial number plate (Item 1) is located on the frame of the machine in the location shown [Figure 1].

Explanation of Excavator Serial Number:

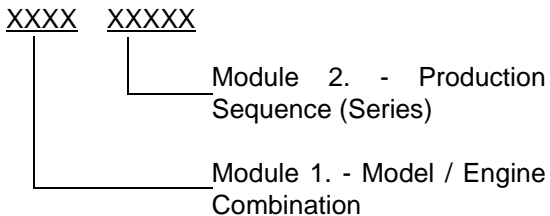

1. The four digit Model/Engine Combination Module number identifies the model number and engine combination.

2. The five digit Production Sequence Number identifies the order which the excavator is produced.

Engine Serial Number

Figure 2

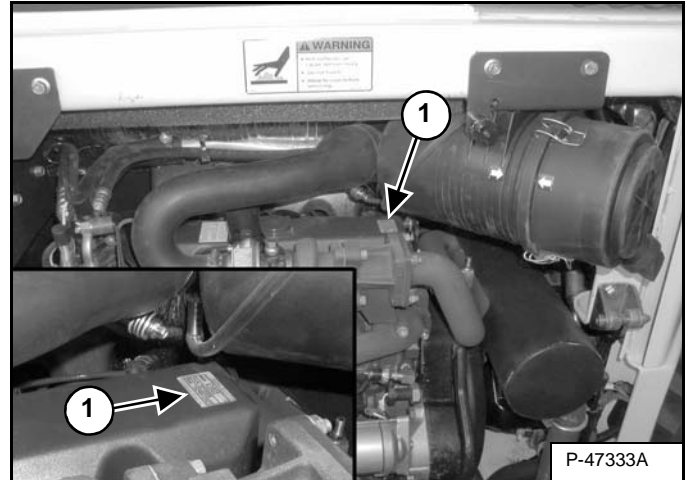

The engine serial number (Item 1) is located on the engine in the location shown [Figure 2].

DELIVERY REPORT

Figure 3

The diagram shows a form titled "DELIVERY REPORT". The form is divided into several sections. At the top, there is a header section with the title "DELIVERY REPORT" and several horizontal lines for text. Below this, the form is split into two columns. The left column contains a section with a dark background and the word "WARNING" in white, followed by several horizontal lines. The right column contains several horizontal lines. At the bottom of the form, there is a small rectangular box containing the text "B-16315".

The delivery report must be filled out by the dealer and signed by the owner or operator when the Bobcat Excavator is delivered. An explanation of the form must be given to the owner. Make sure it is filled out completely **[Figure 3]**.

BOBCAT EXCAVATOR IDENTIFICATION

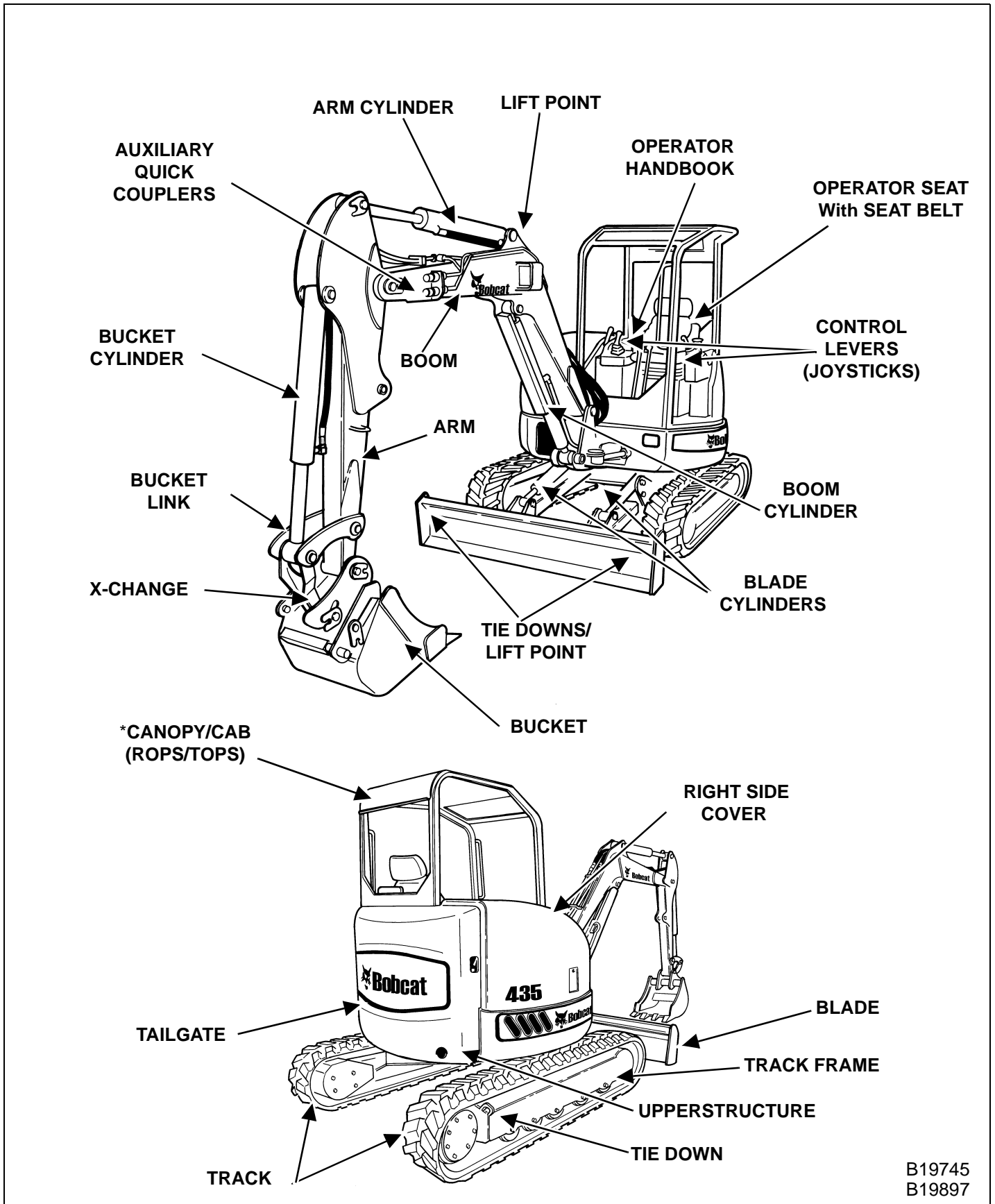

B19745
B19897

* FOGS (Falling Object Guards) is available from your Bobcat Excavator dealer.

SAFETY AND MAINTENANCE

SAFETY & MAINTENANCE

AIR CLEANER	10-60-1
Daily Check	10-60-1
Replacing The Filters	10-60-1
COOLING SYSTEM	10-70-1
Checking Coolant Level	10-70-1
Cleaning The Cooling System	10-70-1
Replacing The Coolant	10-70-2
ENGINE ACCESSORY DRIVE BELT	10-140-1
Belt Adjustment	10-140-1
Belt Tension	10-140-1
ENGINE LUBRICATION SYSTEM	10-90-1
Checking Engine Oil	10-90-1
Replacing Oil And Filter	10-90-1
FUEL SYSTEM	10-80-1
Draining The Fuel Tank	10-80-2
Filling The Fuel Tank	10-80-1
Fuel Specifications	10-80-1
Inline Fuel Filter	10-80-3
Spin On Fuel Filter	10-80-3
Removing Water From The Fuel Filter	10-80-2
HEATER AIR FILTER (WITH CAB OPTION ONLY)	10-61-1
Removal And Installation	10-61-1
HYDRAULIC SYSTEM	10-100-1
Checking And Adding Hydraulic Oil	10-100-1
Diagnostic Couplers	10-100-5
Replacing The Fan Filter	10-100-4
Replacing The Case Drain Filter	10-100-3
Replacing The Hydraulic Filter	10-100-3
Replacing The Hydraulic Oil	10-100-2
LIFTING AND BLOCKING THE EXCAVATOR	10-10-1
Procedure	10-10-1
LIFTING THE EXCAVATOR	10-12-1
LUBRICATION OF THE HYDRAULIC EXCAVATOR	10-110-1

Continued On Next Page

SAFETY AND MAINTENANCE (CONT'D)

OPERATOR CAB (ROPS/TOPS)	10-20-1
Cab Door	10-20-3
Emergency Exit (Early Models)	10-20-1
Emergency Exit (Later Models)	10-20-2
Front Window	10-20-4
Right Side Windows (Early Models)	10-20-5
Right Side Windows (Later Models)	10-20-6
RIGHT SIDE COVER	10-41-1
Opening And Closing The Right Side Cover	10-41-1
SERVICE SCHEDULE	10-50-1
Chart	10-50-1
SPARK ARRESTOR MUFFLER	10-130-1
TAILGATE	10-40-1
Adjusting The Latch	10-40-1
Opening And Closing The Tailgate	10-40-1
TRANSPORTING THE EXCAVATOR	10-30-1
Procedure	10-30-1
TRAVEL MOTOR	10-120-1
Checking Oil Level	10-120-1
Draining The Travel Motor	10-120-1
UPPERSTRUCTURE SLEW LOCK	10-11-1
Operation	10-11-1

LIFTING AND BLOCKING THE EXCAVATOR

Procedure

Figure 10-10-1

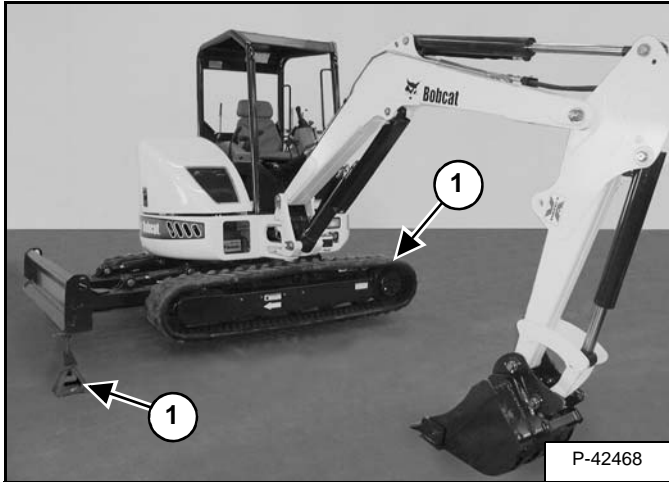

Raise one side of the machine (approximately four inches) using the boom and arm [Figure 10-10-1].

Raise the blade fully and install jack stands under the blade and track frame (Item 1) [Figure 10-10-1]. Lower the boom until all machine weight is on the jack stands.

Repeat the procedure for the other side.

Stop the engine.

WARNING

AVOID INJURY OR DEATH

Keep fingers and hands out of pinch points when checking the track tension.

W-2142-0189

WARNING

Put jackstands under the blade and rear corners of the undercarriage before working under the machine. Failure to block up the machine may allow it to move or fall and result in injury or death.

W-2218-1195

UPPERSTRUCTURE SLEW LOCK

Operation

There is not a mechanical upperstructure slew lock to engage or disengage.

This Excavator is equipped with an automatically applied slew brake integrated into the slew motor.

When the upperstructure slew circuit is engaged, hydraulic pressure unlocks the slew motor.

When the upperstructure slew circuit is disengaged, spring pressure applies the internal slew motor brake.

LIFTING THE EXCAVATOR

Figure 10-12-1

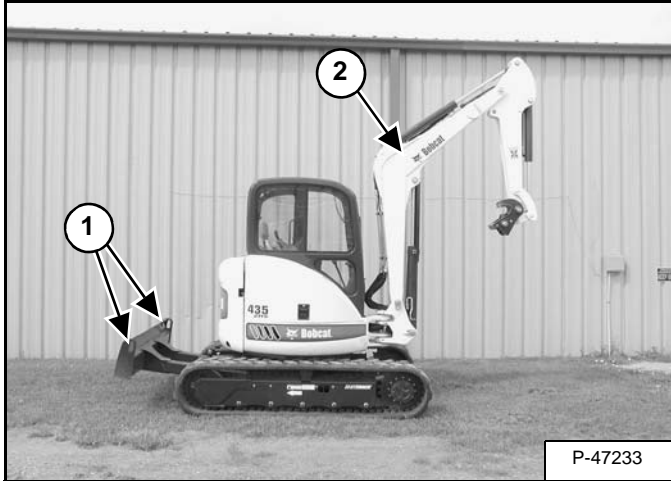

Fully extend the cylinders of the bucket, arm, and boom so that the Excavator is in the position as shown [Figure 10-12-1].

Raise the blade all the way.

Put all the control levers in neutral.



AVOID INJURY OR DEATH

- Use a lifting fixture with sufficient capacity for the weight of the Excavator plus any added attachments.
- Maintain center of gravity and balance when lifting.
- Do not swing boom or upperstructure. Engage the swing locking lever.
- Never lift with operator on machine.

W-2202-0595

Figure 10-12-2

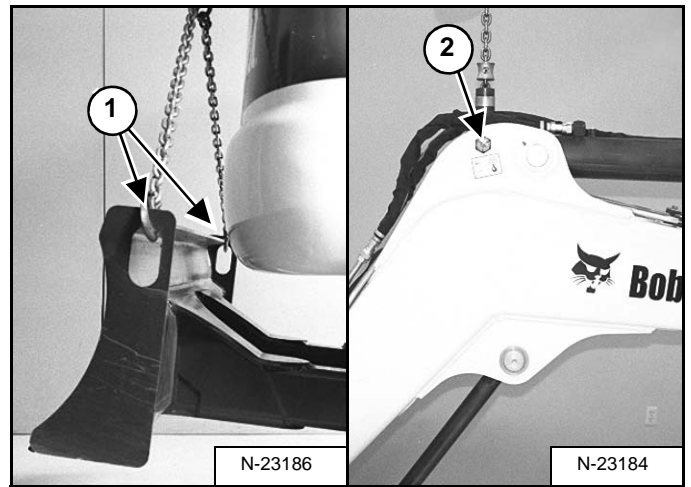

Fasten chains to the ends of the blade (Item 1) [Figure 10-12-1] and [Figure 10-12-2] and up to a lifting fixture above the canopy/cab. The lifting fixture must extend over the sides of the canopy/cab to prevent the chains from hitting the ROPS/TOPS.

Install a one inch (25 mm) bolt and nut (Grade 5 or 8) through the holes at the boom (Item 2) [Figure 10-12-1] and [Figure 10-12-2]. Fasten a chain from the bolt to the lift fixture.

OPERATOR CAB (ROPS/TOPS)

Emergency Exit (Early Models)

The left door, front window, and right front window provide exits.

Figure 10-20-1

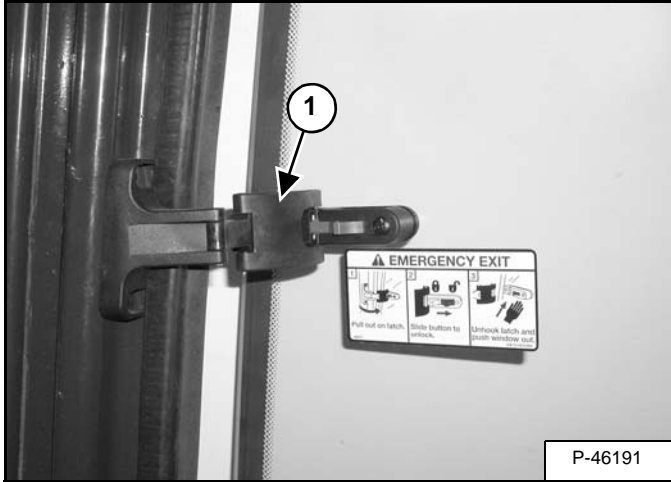

Pull out and fully extend the latch (Item 1) [Figure 10-20-1].

Figure 10-20-2

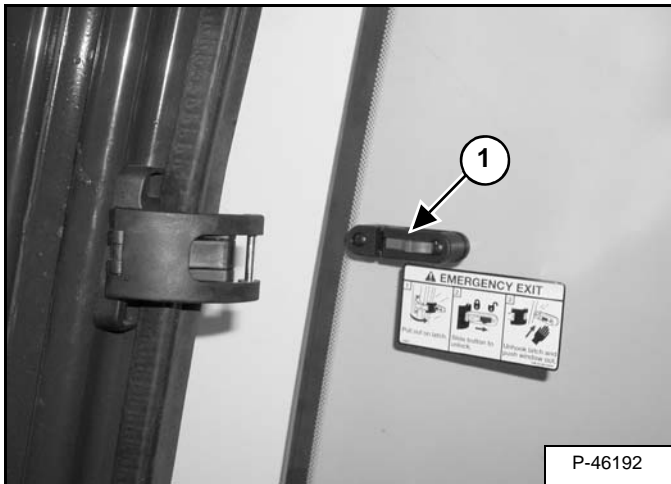

Slide the button (Item 1) [Figure 10-20-2] to unlock the window latch.

Figure 10-20-3



Unhook the latch and push the window all the way open. Exit through the window [Figure 10-20-3].

Figure 10-20-4



Raise the front window and exit through the window [Figure 10-20-4].

OPERATOR CAB (ROPS/TOPS) (CONT'D)

Emergency Exit (Later Models)

The left door, front window, and right rear window provide exits.

Figure 10-20-5

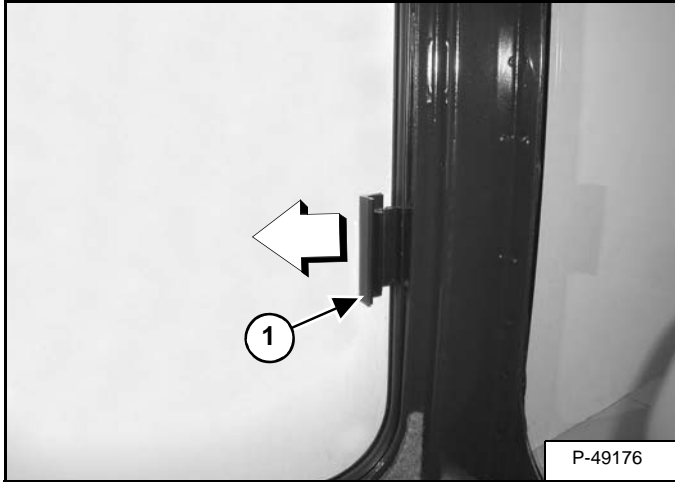

Pull forward on the latch (Item 1) [Figure 10-20-5].

Figure 10-20-6

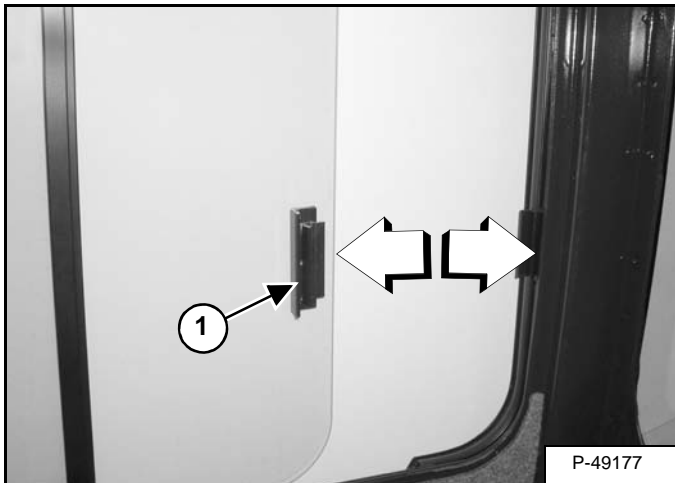

Pull the latch/handle (Item 1) [Figure 10-20-6] forward to open the window.

Push the handle back to close the window.

Figure 10-20-7



Exit through the window [Figure 10-20-7].

Figure 10-20-8



Raise the front window and exit through the window [Figure 10-20-8].

OPERATOR CAB (ROPS/TOPS) (CONT'D)

Cab Door

Figure 10-20-9

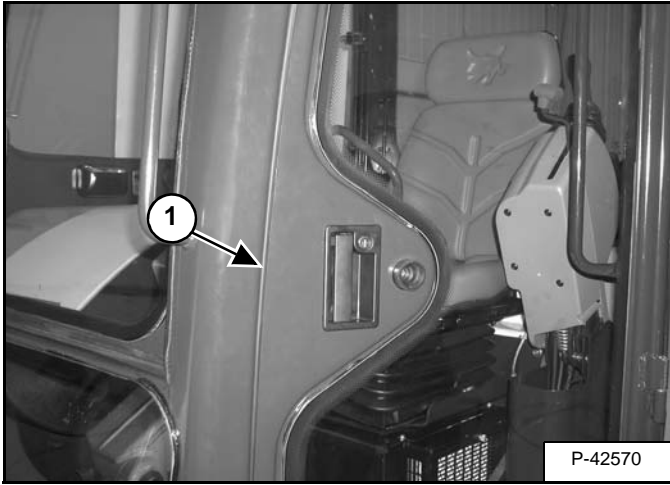

The cab door (Item 1) [Figure 10-20-9] can be locked with the same key as the starter switch (if equipped).

Push the door all the way open until the latch engages to hold the door in the open position.

Figure 10-20-10



Firmly pull the door away from the cab to disengage the latch and close the door [Figure 10-20-10].

OPERATOR CAB (ROPS/TOPS) (CONT'D)

Front Window

Figure 10-20-11

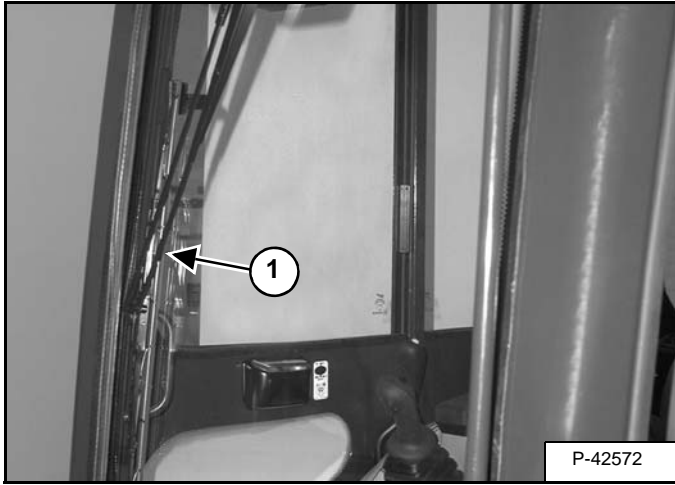

The front window is equipped with a wiper (Item 1) [Figure 10-20-11] and washer.

Opening The Front Window

Figure 10-20-12

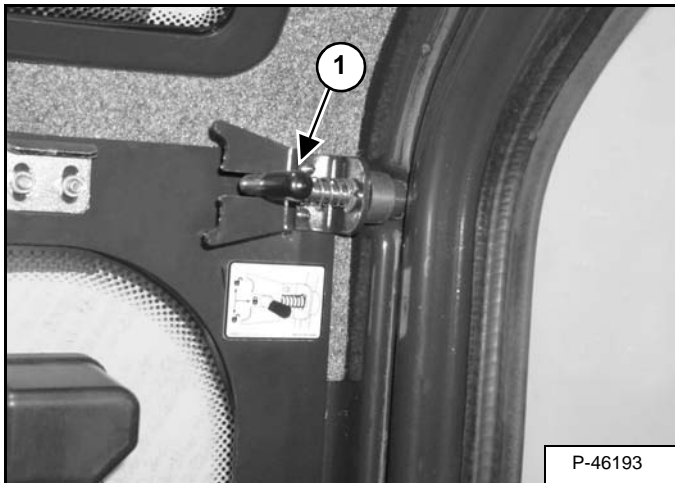

Retract the two top window latch pins (Item 1) [Figure 10-20-12].

Figure 10-20-13

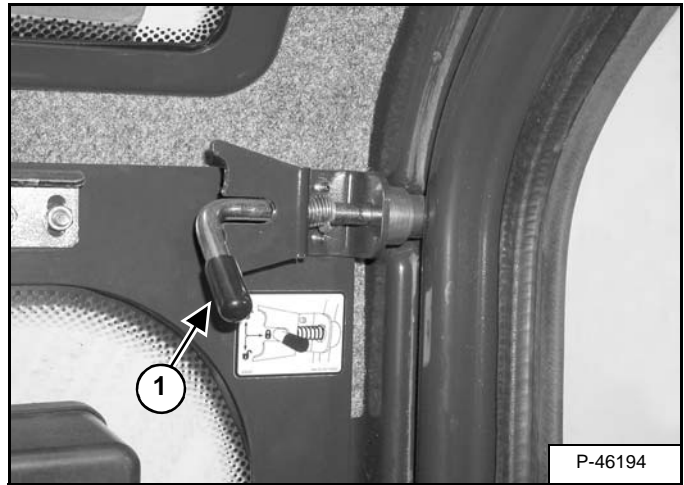

Turn the two top latches (Item 1) [Figure 10-20-13] to the unlocked position.

Figure 10-20-14



Use both window grab handles to pull the top of the window in [Figure 10-20-14].

Continue moving the window in and up over the operator's head until the window is fully raised.

OPERATOR CAB (ROPS/TOPS) (CONT'D)

Front Window (Cont'd)

Figure 10-20-15

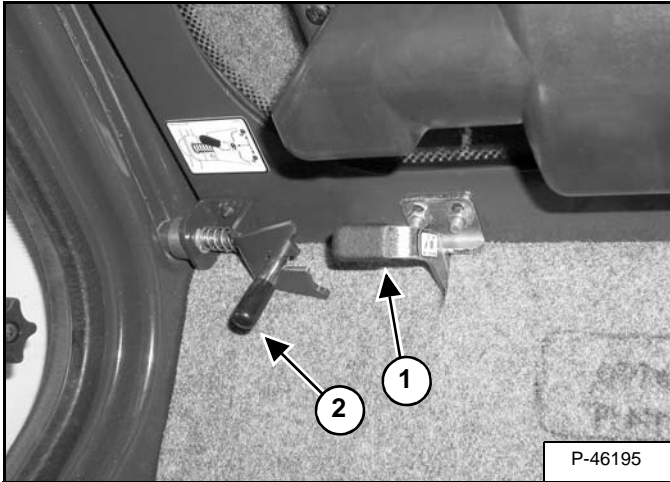

When the window is fully raised, the latch (Item 1) will close on the bracket. Turn the two top latches (Item 2) [Figure 10-20-15] to the locked position.

Closing The Front Window

Support the window while releasing both window latch pins and placing the pins in the unlocked position [Figure 10-20-15].

Support the window using the left grab handle and pull down on the latch (Item 1) [Figure 10-20-15] to release the window.

Use both window grab handles to pull the window down [Figure 10-20-14].

Rotate the top latches (Item 1) [Figure 10-20-13 on Page 4] to the locked position (Item 1) [Figure 10-20-12 on Page 4].

Right Side Windows (Early Models)

Opening the right rear window

Figure 10-20-16

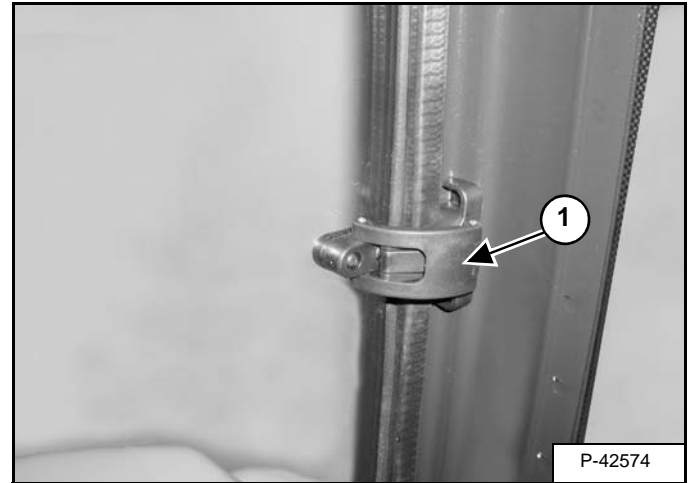

Pull out on the latch (Item 1) [Figure 10-20-16].

Figure 10-20-17

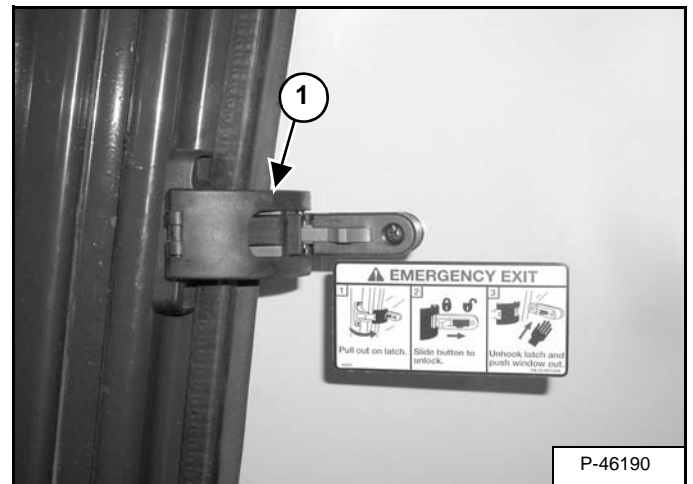

Push out on the window until the latch (Item 1) [Figure 10-20-17] goes over center.

Pull in on the latch to close the window.

OPERATOR CAB (ROPS/TOPS) (CONT'D)

Right Side Windows (Early Models) (Cont'd)

Opening the right front window

Figure 10-20-18

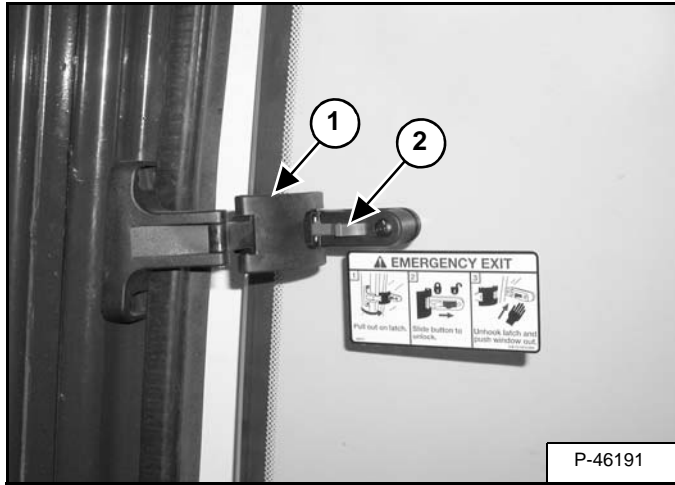

Pull out on the latch (Item 1) [Figure 10-20-18].

Push out on the window until the latch (Item 1) [Figure 10-20-18] goes over center.

To fully open the right front window, slide the button rearward (Item 2) [Figure 10-20-18] to disengage the window latch.

Figure 10-20-19

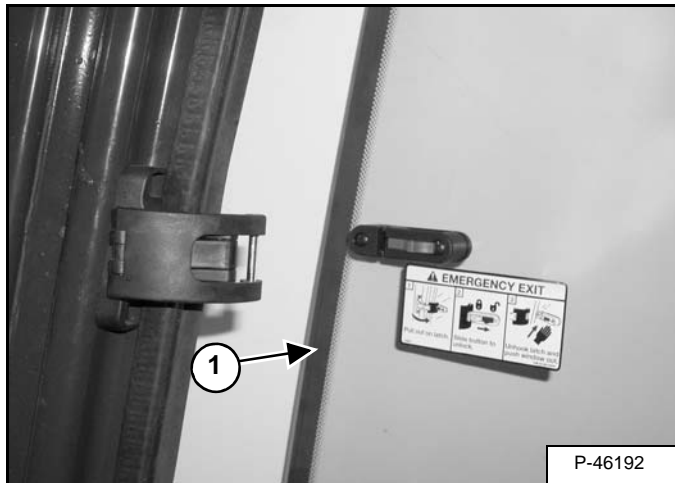

Push the window (Item 1) [Figure 10-20-19] all the way open.

Figure 10-20-20

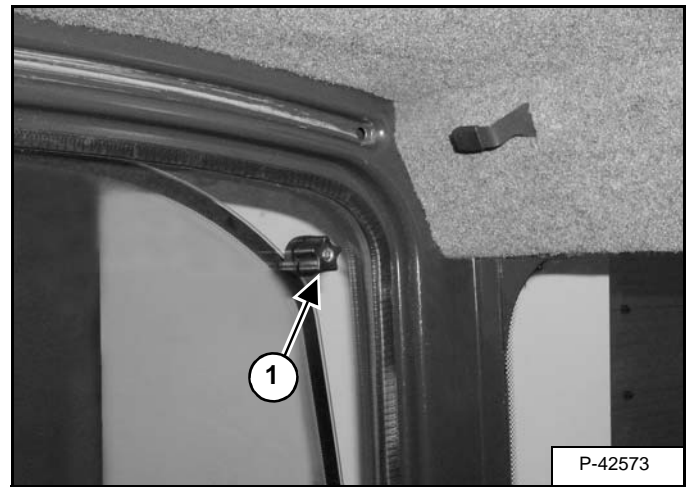

Turn the lock (Item 1) [Figure 10-20-20] to lock the window open.

Right Side Windows (Later Models)

Opening the right rear window

Figure 10-20-21

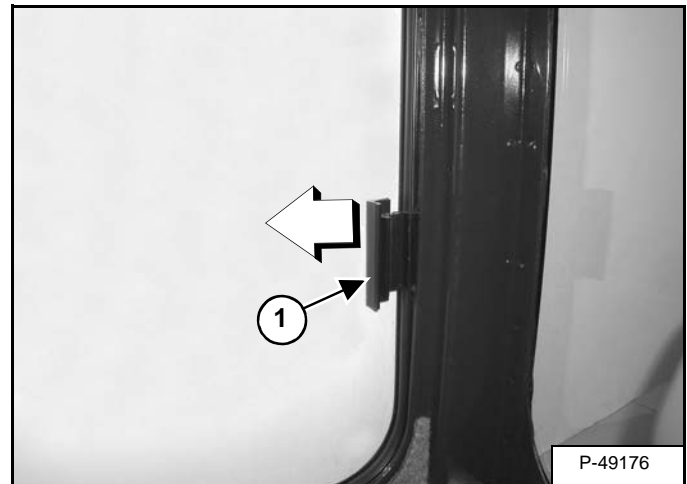

Pull forward on the latch (Item 1) [Figure 10-20-21].

OPERATOR CAB (ROPS/TOPS) (CONT'D)

Right Side Windows (Later Models) (Cont'd)

Figure 10-20-22

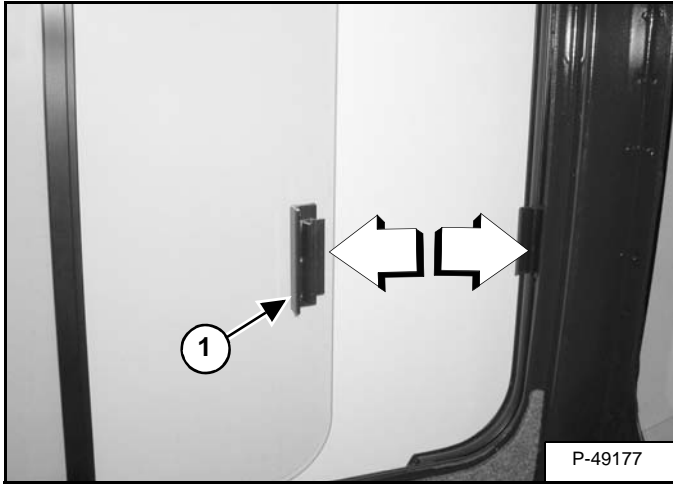

Pull the latch/handle (Item 1) [Figure 10-20-22] forward to open the window.

Push the handle back to close the window.

Opening the right front window

Figure 10-20-23

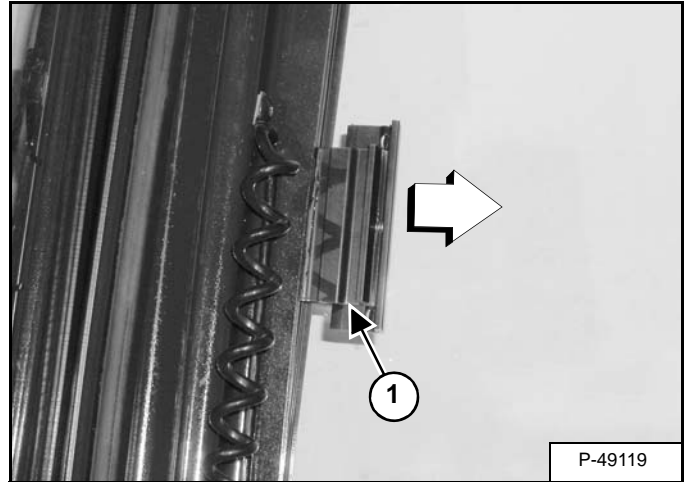

Pull back on the latch (Item 1) [Figure 10-20-23].

Figure 10-20-24

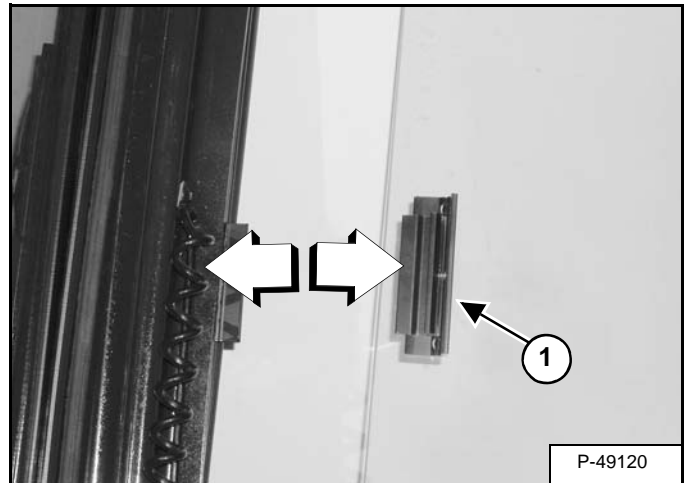

Pull the latch/handle (Item 1) [Figure 10-20-24] back to open the window.

Push the handle forward to close the window.

TRANSPORTING THE EXCAVATOR

Procedure

When transporting the machine, observe the rules, motor vehicle laws, and vehicle limit ordinances. Use a transport and towing vehicle of adequate length and capacity.

Secure the parking brakes and block the wheels of the transport vehicle.

Align the ramps with the center of the transport vehicle. Secure the ramps to the truck bed and be sure ramp angle does not exceed 15 degrees.

Use metal loading ramps with a slip resistant surface.

Use ramps that are the correct length and width and can support the weight of the machine.

The rear of the trailer must be blocked or supported when loading or unloading the Excavator to prevent the front of the transport vehicle from raising.

Determine the direction of the track movement before moving the machine (blade forward).

Engage the slew lock.

Figure 10-30-1



Move the machine forward onto the transport vehicle [Figure 10-30-1].

Do not change direction of the machine while it is on the ramps.

Lower the boom, arm, bucket and blade to the transport vehicle.

Stop the engine and remove the key (if equipped).

Put blocks at the front and rear of the tracks.

Figure 10-30-2

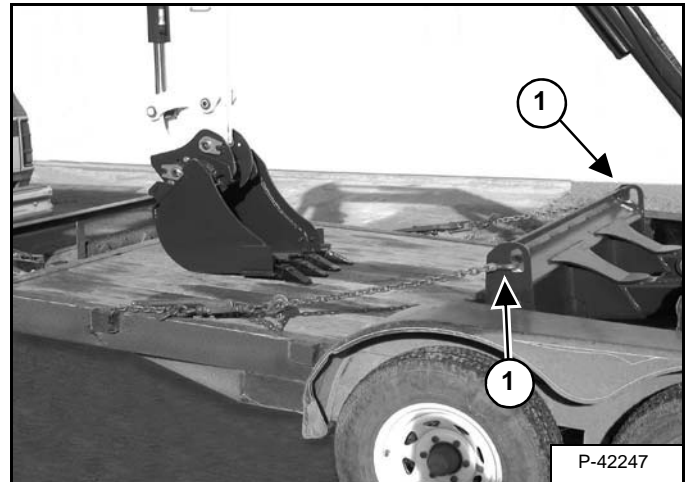
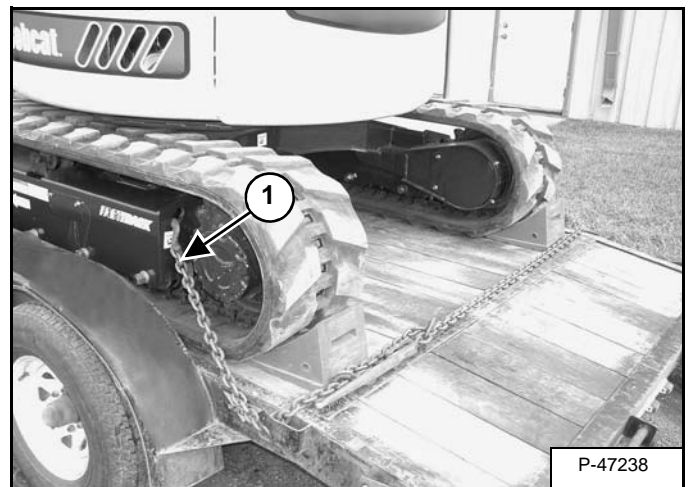

Figure 10-30-3



Fasten chains to the front corners of the blade (Item 1) [Figure 10-30-2] and to the tie down loop at the rear (Item 1) [Figure 10-30-3] to prevent it from moving when going up or down slopes, or during sudden stops.

Use chain binders to tighten the chains and then safely tie the chain binder levers to prevent loosening.

WARNING

Adequately designed ramps of sufficient strength are needed to support the weight of the machine when loading onto a transport vehicle. Wood ramps can break and cause personal injury.

W-2058-0494

TAILGATE

Opening And Closing The Tailgate



AVOID INJURY OR DEATH

Never service or adjust the machine when the engine is running unless instructed to do so in the manual.

W-2012-0497



Keep the rear door closed when operating the machine. Failure to do so could seriously injure a bystander.

W-2020-1285

Figure 10-40-1



Pull the latch (Item 1) [Figure 10-40-1] and pull the tailgate open.

Push firmly to close the tailgate.

Adjusting The Latch

Figure 10-40-2

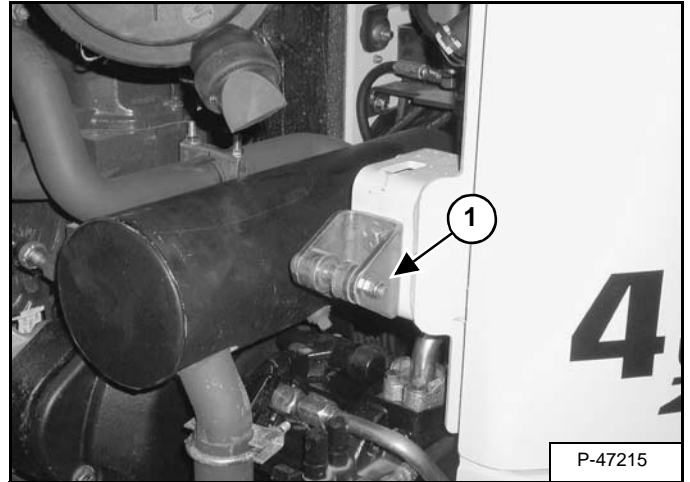

The door catch (Item 1) [Figure 10-40-2] can be adjusted for alignment.

Close the tailgate before operating the Excavator.



Suggest:

If the above button click is invalid.

Please download this document

first, and then click the above link

to download the complete manual.

Thank you so much for reading

RIGHT SIDE COVER

Opening And Closing The Right Side Cover

Figure 10-41-1

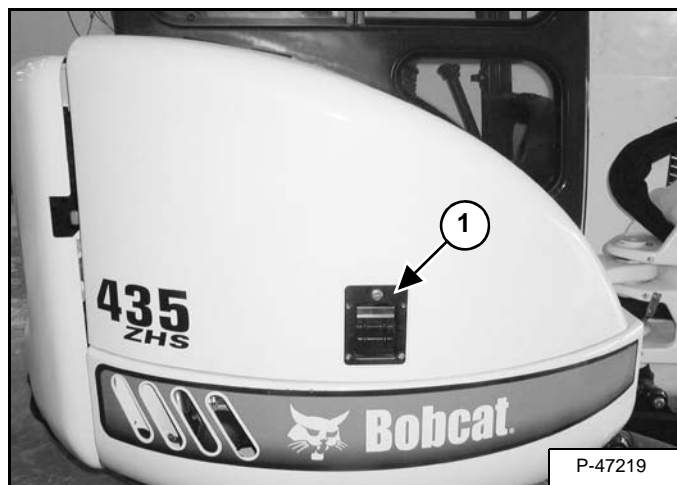

Pull the latch (Item 1) [Figure 10-41-1] and raise the right side cover.

NOTE: The right side cover can be locked using the start key.

<https://www.ebooklibonline.com>

Hello dear friend!

Thank you very much for reading.

Enter the link into your browser.

The full manual is available for immediate download.

<https://www.ebooklibonline.com>