

SERVICE MANUAL
Grader

845
865
885

6-46503

1. Trim along dashed line.
2. Slide into pocket on Binder Spine.

TYPE 1-4

SERVICE MANUAL
Grader

845
865
885

6-46503

1. Trim along dashed line.
2. Slide into pocket on Binder Spine.

TYPE 1-4

SERVICE MANUAL
Grader

845
865
885

6-46503

1. Trim along dashed line.
2. Slide into pocket on Binder Spine.

TYPE 1-4

SERVICE MANUAL
Grader

845
865
885

6-46503

1. Trim along dashed line.
2. Slide into pocket on Binder Spine.

TYPE 1-4

845 - 865 - 885 GRADER
Service Manual
Brz 6-46503
Table of Contents

| Description | Section Number | Publication Form Number |
|--|----------------|----------------------------|
| General | | Tab 1 |
| Section Index - General | | 6-46521 |
| Special Tools - Cross Reference Guide | 1000 | 6-15050 |
| Standard Torque Specifications | 1001 | 6-46530 |
| Fluids and Lubricants | 1002 | 6-46541 |
| Metric Conversion Chart | 1003 | 6-46550 |
| Service Tools | 1005 | 6-75330 |
| Loctite Product Chart | | 8-98902 |
| Engine | | Tab 2 |
| Section Index - Engines | | 6-46561 |
| For Engine Repair, See the Engine Service Manual | | |
| Charge Air Cooler | 2002 | 6-75420 |
| Fuel System | | Tab 3 |
| Section Index - Fuel System | | 6-46591 |
| For Fuel System Repair, See the Engine Service Manual | | |
| Electrical | | Tab 4 |
| Section Index - Electrical | | 6-46601 |
| Removal and Installation of Starter and Alternator | 4001 | 6-42322 |
| Electrical Diagram | 4002 | 6-46621 |
| Battery | 4003 | 6-42331 |
| Alternator 45 Ampere | 4008 | 6-42361 |
| Steering | | Tab 5 |
| Section Index - Steering | | 6-46661 |
| Front Wheel, Axle and Wheel Lean | 5002 | 6-46681 |
| Steering Control Valve (845 - 865 - 885 Grader) | 5003 | 6-46691 |
| Steering Priority Valve (845 - 865 - 885 Grader) | 5004 | 6-46701 |
| Power Train | | Tab 6 |
| Section Index - Power Train | | 6-46731 |
| Transmission Specifications, Pressure Checks and Troubleshooting (845 - 865 Grader) | 6002 | 6-46751 |

845 - 865 - 885 GRADER Service Manual Brz 6-46503

Table of Contents (Continued)

| Description | Section Number | Publication Form Number |
|---|----------------|-------------------------|
| Transmission Specifications, Pressure Checks and Troubleshooting (885 Grader) | 6002 | 6-75350 |
| Transmission (845 - 865 Grader) | 6003 | 6-46761 |
| Transmission (885 Grader) | 6003 | 6-75360 |
| Rear Axle With Differential Lock | 6005 | 6-75370 |
| Limited Slip Rear Axle 845-865 Grader | 6005 | 6-46782 |
| Tandem Drive Limited Slip Rear Axle 845-865 Grader | 6006 | 6-46792 |
| Tandem Drive Differential Hydraulic Lock | 6006 | 6-75380 |
| Brakes | | Tab 7 |
| Section Index - Brakes | | 6-46810 |
| Hydraulic Brake Troubleshooting | 7002 | 6-46831 |
| Brake Pedal Valve System | 7003 | 6-46842 |
| Hydraulics | | Tab 8 |
| Section Index - Hydraulics | | 6-46861 |
| Removal and Installation of Hydraulic Components | 8001 | 6-46872 |
| Hydraulic Schematics | 8002 | 6-75400 |
| Mounted Equipment | | Tab 9 |
| Section Index - Mounted Equipment | | 6-46931 |
| Air Conditioning Troubleshooting | 9002 | 6-46950 |
| Air Conditioning Troubleshooting For Systems With HFC 134A Refrigerant | 9002 | 6-75390 |
| Air Conditioner System Operating Instructions | 9003 | 6-46960 |
| Air Conditioner System Service | 9003 | 6-42650 |
| Removal and Installation of Air Conditioning Components for Systems with HFC 134A Refrigerant | 9004 | 6-46971 |
| Rear Ripper | 9007 | 6-47011 |
| Frame, Articulation Joint, Circle and Scarifier | 9008 | 6-47001 |
| Front Blade and Counterweight | 9009 | 6-47021 |
| ROPS Cab | 9010 | 6-47031 |
| Cab Glass Installation | 9011 | 6-47041 |

NOTE: CNH Latino Americana reserves the right to make improvements in design or changes in specifications at any time without incurring any obligation to install them on units previously sold.

SECTION INDEX

GENERAL

| Section Title | Section Number |
|---|-----------------------|
| Special Tools - Cross Reference Guide | 1000 |
| Standard Torque Specifications | 1001 |
| Fluid and Lubricants | 1002 |
| Metric Conversion Chart | 1003 |
| Loctite Product Chart | |
| Service Tools | 1005 |

Section 1000

SPECIAL TOOLS Cross Reference Guide

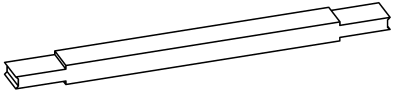
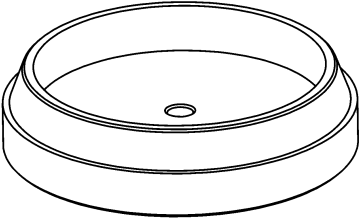
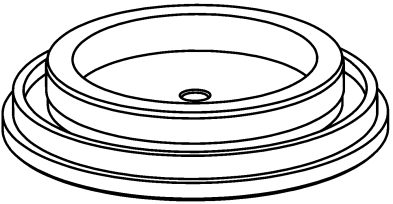
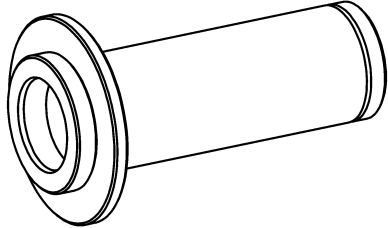
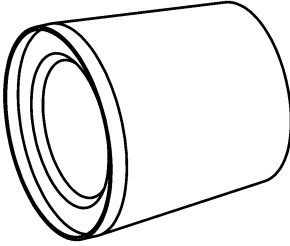
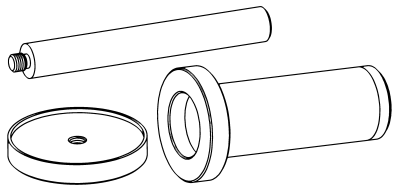
| | Description | Old Number | New Number |
|---|-----------------------------------|------------|------------|
|  | Axle Brake Disc Go/No Go Gauge | 75301703 | 380000378 |
|  | Axle Seal Installer | 75301704 | 380000379 |
|  | Axle Seal Installer | 75301705 | 380000380 |
|  | Transmission Input Seal Installer | 75310180 | 380000387 |
|  | Transmission Oil Seal Guide | 75310181 | 380000388 |
|  | Transmission Seal Driver | 75310185 | 380000391 |

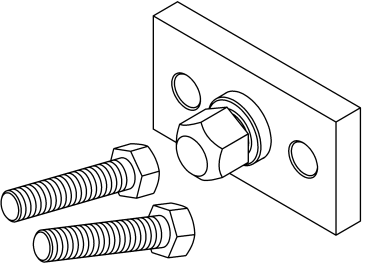
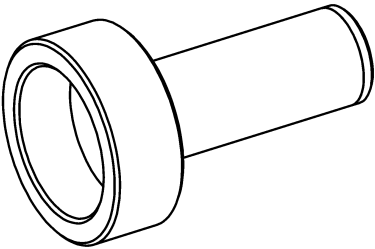
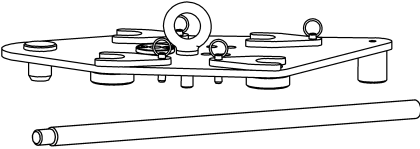
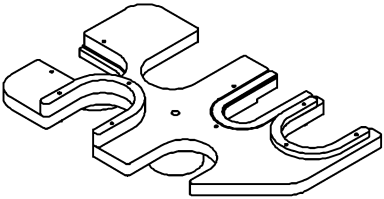
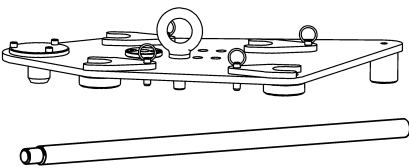
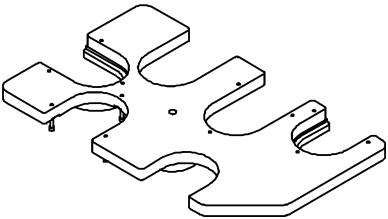
| | Description | Old Number | New Number |
|---|----------------|------------|------------|
|  | Hub Remover | 75312684 | 380000394 |
|  | Seal Driver | 75310190 | 380000397 |
|  | Lifting Device | 75289947 | 380000374 |
|  | Stack Nest | 75289948 | 380000375 |
|  | Lifting Device | 75289949 | 380000376 |
|  | Stack Nest | 75289950 | 380000377 |

Section 2002

CHARGE AIR COOLER SYSTEM

845

P.I.N. HBZ020101 AND AFTER

865

P.I.N. HBZ022101 AND AFTER

885

P.I.N. HBZ024101 AND AFTER

2002- 4

Charge Air Cooler Removal

Removal of the air cooler to turbocharger outlet piping

- 1 - Remove clamps (A)
- 2 - Remove hose (B)

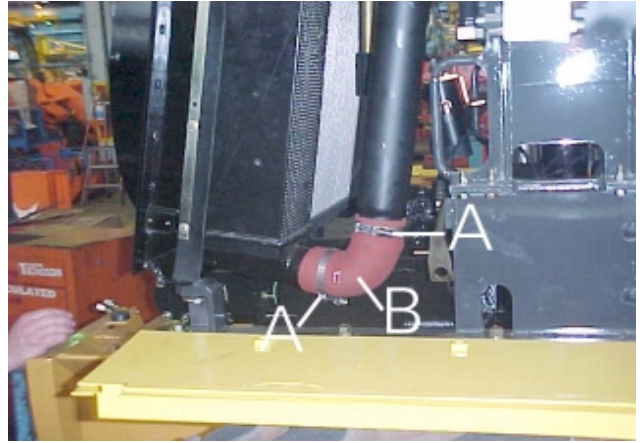

- 3 - Remove bolt (C) and remove clamp (D)



- 4 - Remove clamps (F) then remove tube (E) and hose (G).

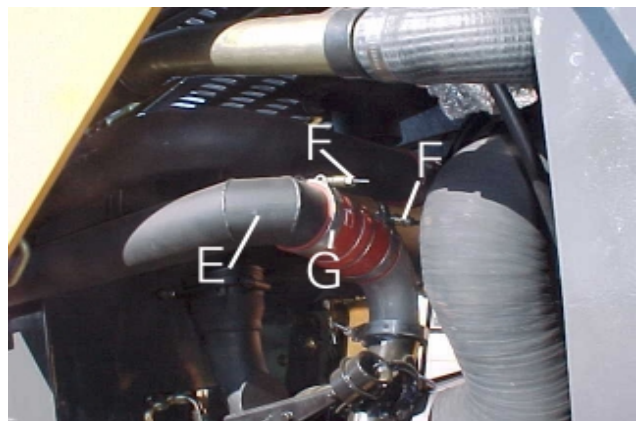

2002- 5

Charge Air Cooler Removal

Air inlet to cooler pipe removal

- 1 - Remove clamps (1)
- 2 - Remove hose (2)



- 3 - Remove clamps (3)
- 4 - Remove hose (4)
- 5 - Remove tube (5)

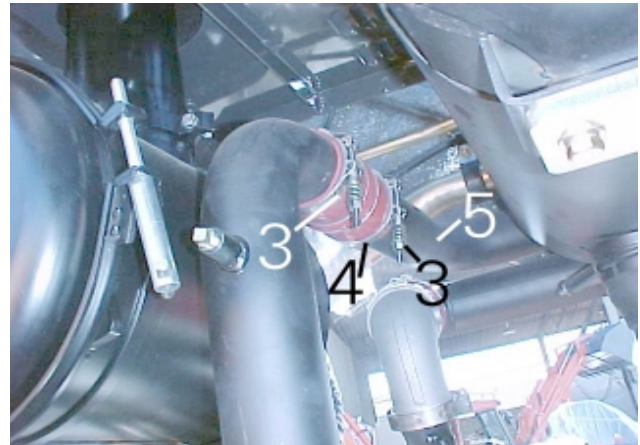

- 6 - Remove bolts (6)
- 7 - Remove tube (7)
- 8 - Remove gasket (8)



2002- 6

Charge Air Cooler Removal

Air cooler removal

1 - Remove top bolts (9)

1

2 - Remove bottom bolts (10)

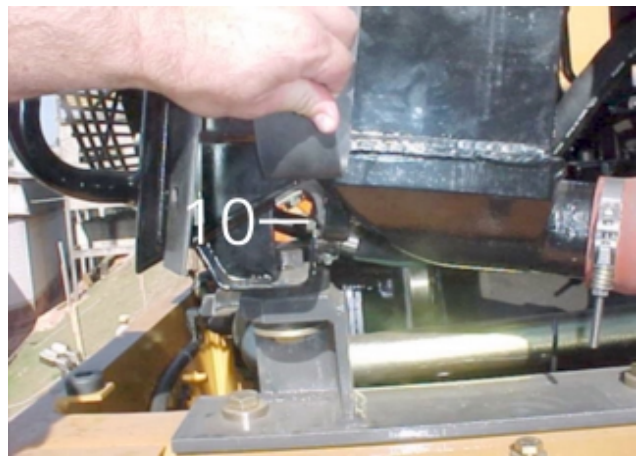
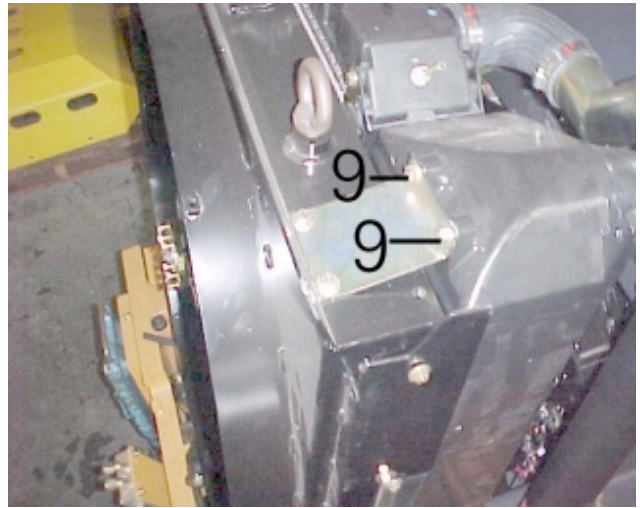

Air cooler assembly.

- 1 - Place air cooler in the correct position.
- 2 - Fit top bolts (9) and torque to 2,8 kfg.
- 3 - Fit bottom bolts (10) and torque to 2,8 kfg.

2002- 7

Charge Air Cooler Installation

Assembly of air cooler outlet to turbocharger pipe

- 1 - Fit hose (B) to the cooler outlet opening. Then fit clamps (A) in place and fit tube (E) to hose (B). Adjust clamps until the clamp springs are fully compressed.
- 2 - Fit hose (A) to tube (E). Then fit hoses (F) in place and fit hose (G) to the turbocharger inlet tube. Adjust clamps until the clamp springs are fully compressed.

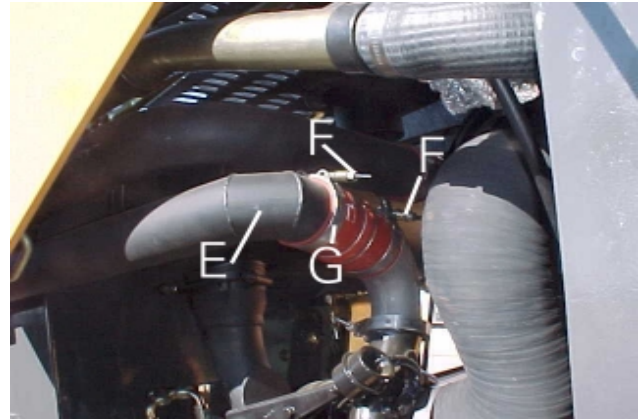

Cooler air inlet pipe assembly.

- 1 - Fit hose (2) to the cooler inlet opening. Then fit clamps (1) in place and fit tube (5).
- Adjust clamps until the clamp springs are fully compressed.



- 2 - Fit hose (4) to tube (5). Then fit clamps (3) in place and fit tube (7).
- Adjust clamps until the clamp springs are fully compressed.

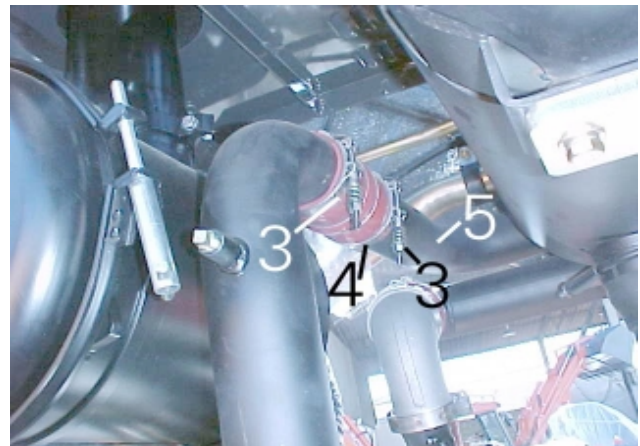

2002- 8

3 - Fit gasket (4) between tube (7) and engine cover.
Then fit bolts (6) in place and torque to 2,8 kgf.



4 - Fit clamp (d) in place and torque bolts (C) to 2,8 kgf.



STARTER

Removal

NOTE: *The starter is located on the left side of the engine, mounted to the engine flywheel housing.*

1. Turn the master disconnect switch to the OFF position.
2. Remove the air cleaner and the air cleaner bracket.
3. Move the cover to gain access to the bolt (2). Refer to the illustration below.

Installation

1. Install the starter (1), and bolts (2) to the machine. Torque the bolt (2) to 41 to 74 Nm (30 to 54 pound-feet).
2. Install the positive cables.

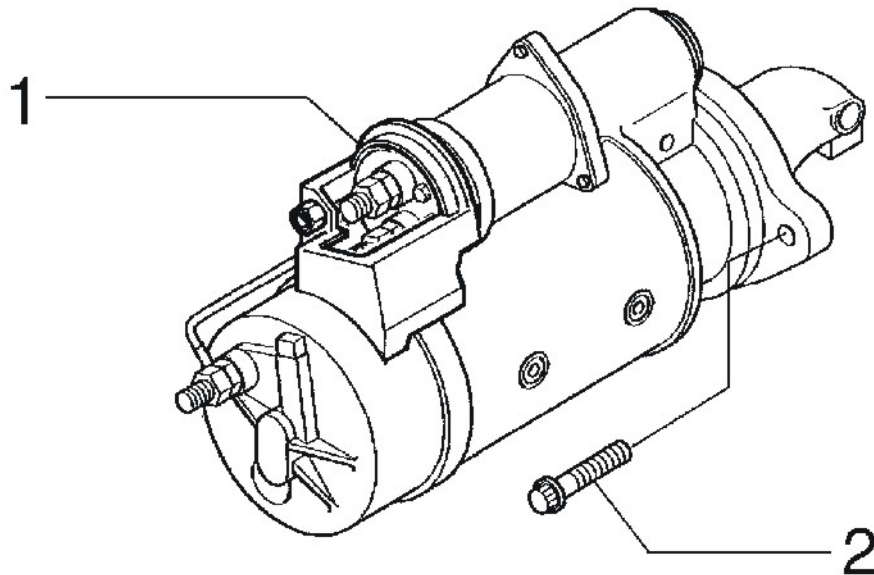

1. STARTER
2. BOLT

STARTER REMOVAL AND INSTALLATION

ALTERNATOR 45A

Removal

1. Turn the master disconnect switch to the OFF position.
2. Use a wrench to move the belt tensioner (15) and loosen the tension on the belt (17). Refer to the illustration on the following page.
3. Remove the belt (17).
4. Remove the boots (4 and 5).
Tag and disconnect wires (12 and 13) from the alternator (6).
5. Remove the bolt (8), and washer (9) from the support bracket (7) and the alternator (6).
6. Remove the alternator (6) and shield (3) from the machine.
- .
- .

Installation

1. Install the alternator (4), on the machine.
Torque the bolt (0) to 60 to 104 Nm (42.5 to 76 pound-feet).
Refer to the illustration on the following page.
2. Install the washer (9), and bolt (8).
Torque the bolt (8) to 60 to 104 Nm (42.5 to 76 pound-feet).
3. Use a wrench to move the belt tensioner (2) until the belt (1) can be installed.
4. Install the belt (17).
5. Install the wire (12), lockwasher and nut to the alternator's D+ terminal. Torque the nut to 3.5 to 3.9 Nm (2.6 to 2.9 pound-feet).
6. Install the boot.
7. Install the wire (13), lockwasher and nut to the alternator's B+ terminal. Torque the nut to 15 to 27 Nm (11 to 20 pound-feet).
8. Install the boot.
9. Turn the master disconnect switch to the ON position.

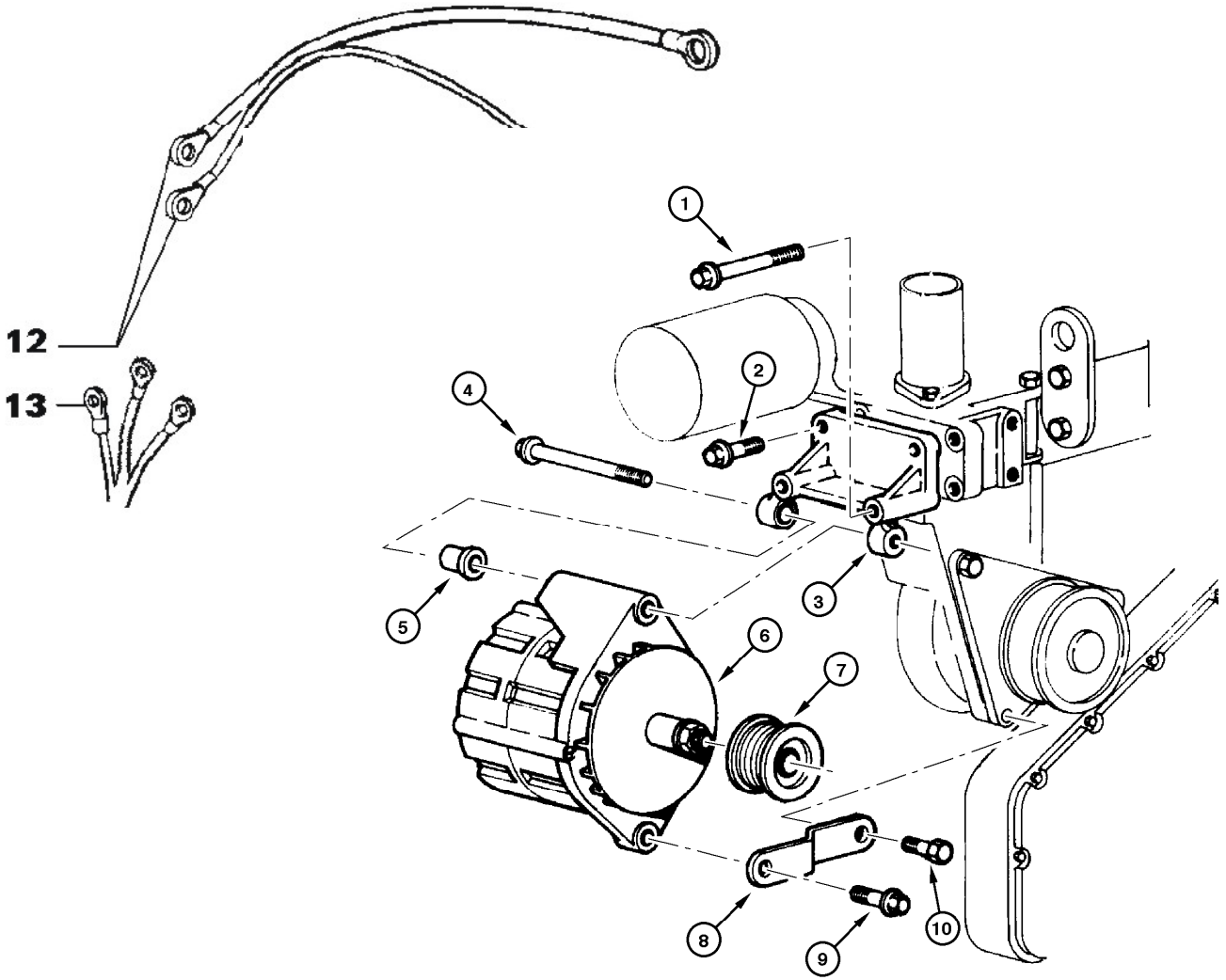

- 1. BOLT
- 2. BOLT
- 3. SUPPORT
- 4. BOLT
- 5. ARM
- 6. BOLT
- 7. BOLT
- 8. ALTERNADOR 45 A
- 9. PULLEY
- 10. BELT

ALTERNATOR 45 A TO MODEL 845 ENGINE CUMMINS SERIES B REMOVAL AND INSTALLATION ILLUSTRATION

ALTERNATOR 70A

Removal

1. Turn the master disconnect switch to the OFF position.
2. Use a wrench to move the belt tensioner (15) and loosen the tension on the belt (17). Refer to the illustration on the following page.
3. Remove the belt (17).
4. Remove the boots (4 and 5). Tag and disconnect wires (12 and 13) from the alternator (6).
5. Remove the bolt (8), and washer (9) from the support bracket (7) and the alternator (6).
6. Remove the alternator (6) and shield (3) from the machine.
- .
- .

Installation

1. Install the alternator (4), on the machine. Torque the bolt (0) to 60 to 104 Nm (42.5 to 76 pound-feet). Refer to the illustration on the following page.
2. Install the washer (9), and bolt (8). Torque the bolt (8) to 60 to 104 Nm (42.5 to 76 pound-feet).
3. Use a wrench to move the belt tensioner (2) until the belt (1) can be installed.
4. Install the belt (17).
5. Install the wire (12), lockwasher and nut to the alternator's D+ terminal. Torque the nut to 3.5 to 3.9 Nm (2.6 to 2.9 pound-feet).
6. Install the boot.
7. Install the wire (13), lockwasher and nut to the alternator's B+ terminal. Torque the nut to 15 to 27 Nm (11 to 20 pound-feet).
8. Install the boot.
9. Turn the master disconnect switch to the ON position.



Suggest:

If the above button click is invalid.

Please download this document

first, and then click the above link

to download the complete manual.

Thank you so much for reading

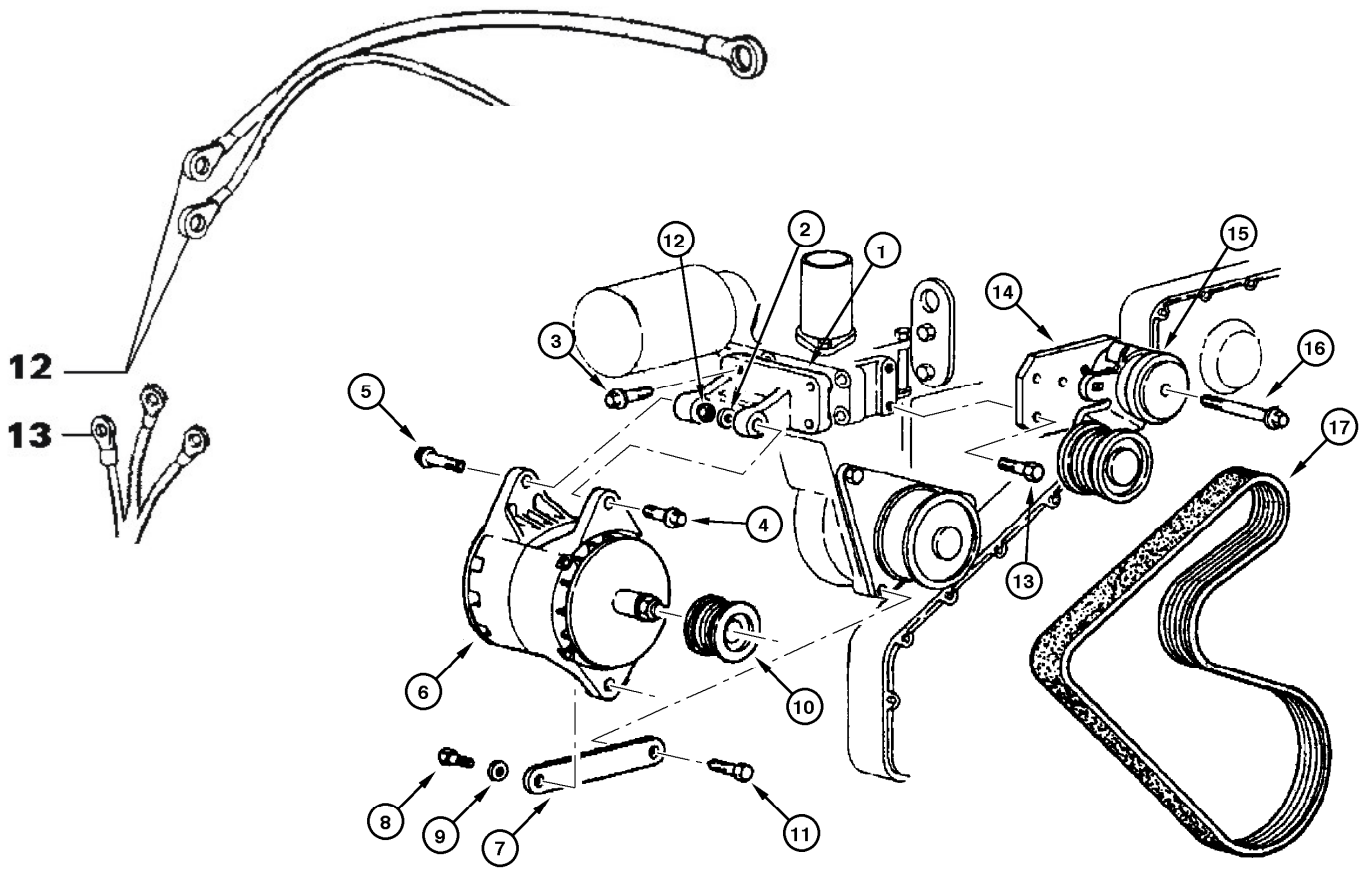

- | | |
|------------|--------------------|
| 1. BOLT | 8. ALTERNATOR 70 A |
| 2. BRACKET | 9. BRACKET |
| 3. BOLT | 10. BOLT |
| 4. BOLT | 11. BOLT |
| 5. BELT | 12. and 13. WIRES |
| 6. PULLEY | |
| 7. WASHER | |

ALTERNATOR 70 A TO MODELS 845 ENGINE CUMMINS SERIES B REMOVAL AND INSTALLATION ILLUSTRATION

<https://www.ebooklibonline.com>

Hello dear friend!

Thank you very much for reading.

Enter the link into your browser.

The full manual is available for immediate download.

<https://www.ebooklibonline.com>