

“L” Series Loader Backhoe Family Service Manual

Table of Contents

Description	Section No.	Form No.
General		
	Tab 1	
Section Index - General		7-48860
Standard Torque Specifications	1001	8-71601
Fluids and Lubricants	1002	7-48632
Loctite Product Chart		8-98900
Engines		
	Tab 2	
Section Index - Engines		7-48870
Engine and Radiator Removal and Installation	2000	7-49650
Stall Tests	2002	7-49320
Specification Details	2402	8-24164
Aftercooler	2411	7-43511
Cylinder Head and Valve Train	2415	8-24174
Cylinder Block	2425	8-24184
Lubrication System	2445	8-24194
Cooling System	2455	8-24204
Turbocharger	2465	8-25551
Turbocharger Failure Analysis	2565	9-78235
Fuel System		
	Tab 3	
Section Index - Fuel System		7-48880
Fuel System and Filters	3410	8-24212
Fuel Injectors	3413	8-24234
CAV Fuel Injection Pump	3414	7-37132
Bosch Fuel Injection Pump	3415	8-37142
Electrical		
	Tab 4	
Section Index - Electrical		7-48890
Removal and Installation of Electrical Components	4000	7-49430
Electrical Specifications and Troubleshooting	4001	7-48642
Batteries	4003	8-49440
Starter and Starter Solenoid	4004	7-48740
Instrument Cluster	4005	7-49560
Alternator	4007	7-49250

CASE CORPORATION
700 STATE STREET
RACINE, WI 53404 U.S.A.

CASE CANADA CORPORATION
3350 SOUTH SERVICE ROAD
BURLINGTON, ON L7N 3M6 CANADA

Bur 7-48854

Reprinted

Copyright © 1996 Case Corporation
Printed in U.S.A.
Issued October 1996

“L” Series Loader Backhoe Family Service Manual

Table of Contents

Description	Section No.	Form No.
Steering		
	Tab 5	
Section Index - Steering		7-48902
Removal and Installation of Steering Components	5000	7-49450
580L - Steering Specifications, Pressure Checks and Troubleshooting	5001	7-48650
580 Super L and 590 Super L - Steering Specifications, Pressure Checks and Troubleshooting	5001	7-49000
Steering Control Valve	5002	7-49461
Steering Cylinders	5003	7-49470
Front Axle - Two Wheel Drive	5005	7-48770
Front Axle - Four Wheel Drive - 580L and 580 Super L	5006	7-49570
Front Axle - Four Wheel Drive - 590 Super L	5006	7-51060
Power Train		
	Tab 6	
Section Index - Power Train		7-48912
Removal and Installation of Power Train Components	6000	7-49580
Transmission Specifications, Pressure Checks and Troubleshooting	6002	7-48660
Wheels and Tires	6003	7-49590
Rear Axle and Planetaries - 580L and 580 Super L	6004	7-48780
Rear Axle and Planetaries - 590 Super L	6004	7-51130
Transmission	6007	7-48790
Brakes		
	Tab 7	
Section Index - Brakes		7-48921
Removal and Installation of Brake Components	7000	7-49600
Master Cylinder	7003	7-49490
Hydraulics		
	Tab 8	
Section Index - Hydraulics		7-48933
Removal and Installation of Hydraulic Components	8001	7-49630
580L - Hydraulic Specifications, Troubleshooting, and Pressure Checks	8002	7-49011
580 Super L and 590 Super L Hydraulic Specifications, Troubleshooting, and Pressure Checks	8002	7-48672
Cleaning the Hydraulic System	8003	7-49640
Hydraulic Pump - 580L	8004	7-49170
Hydraulic Pump - 580 Super L and 590 Super L	8004	7-49180
Loader Control Valve	8005	7-49191
Cylinders	8006	7-49200
Backhoe Control Valve - 580L	8007	7-50760
Backhoe Control Valve - 580 Super L and 590 Super L	8007	7-49210
Auxiliary Control Valve	8008	7-51670
Accumulator for Machines with Optional Ride Control	8009	7-52450
Solenoid Valve for Machines with Optional Ride Control	8010	7-52460

"L" Series Loader Backhoe Family Service Manual

Table of Contents

Description	Section No.	Form No.
Mounted Equipment	Tab 9	
Section Index - Mounted Equipment		7-48942
Pedals and Levers	9001	7-48680
Air Conditioning Troubleshooting For Systems With R-134a Refrigerant	9002	7-50091
Air Conditioning System Gauges and Testing For Systems With R-134a Refrigerant	9003	7-50901
Air Conditioning System Service For Systems With R-134a Refrigerant	9004	7-51030
Air Conditioning Components Service For Systems With R-134a Refrigerant	9005	7-51050
Loader	9006	7-49510
ROPS Cab and Canopy	9007	7-49520
Backhoe	9008	7-49530
Seat and Seat Belts	9009	7-49540
Hydraulic and Electrical Schematic Foldout (580L)	In Rear Pocket	7-48712
Hydraulic and Electrical Schematic Foldout (580 Super L and 590 Super L)	In Rear Pocket	7-48722

<https://www.ebooklibonline.com>

Hello dear friend!

Thank you very much for reading.

Enter the link into your browser.

The full manual is available for immediate download.

<https://www.ebooklibonline.com>

Section 1002

1002

FLUIDS AND LUBRICANTS

CASE CORPORATION
700 STATE STREET
RACINE, WI 53404 U.S.A.

CASE CANADA CORPORATION
3350 SOUTH SERVICE ROAD
BURLINGTON, ON L7N 3M6 CANADA

Bur 7-48632

Copyright © 1996 Case Corporation
Printed in U.S.A.
Issued October, 1996

CAPACITIES AND LUBRICANTS

Engine Oil

Capacity with Filter Change	11.6 U.S. quarts (11 litres)
Type of oil	See Engine Oil Recommendations on page 4

Engine Cooling System

Capacity without heater	16.7 U.S. quarts (15.8 litres)
Capacity with heater	17.4 U.S. quarts (16.5 litres)
Type of coolant	Ethylene glycol and water mixed for the lowest ambient temperature At least 50/50 mix

Fuel Tank

Capacity	31.4 U.S. gallons (123 litres)
Type of fuel	See diesel fuel specifications on page 5

Hydraulic System

Hydraulic reservoir refill capacity with filter change	14.4 U.S. gallons (54.5 litres)
Hydraulic reservoir refill capacity without filter change	13.9 U.S. gallons (52.6 litres)
Type of oil	Case TCH Fluid

Transmission

2 Wheel Drive

Total System	19.5 U.S. quarts (18.5 litres)
Refill with or without filter	16.9 U.S. quarts (16 litres)
Type of oil	Case Hy Tran Plus® (MS1207)

4 Wheel Drive

Total System	22 U.S. quarts (21 litres)
Refill with or without filter	19.5 U.S. quarts (18.5 litres)
Type of oil	Case Hy Tran Plus® (MS1207)

Front Axle - Four Wheel Drive - 580L and 580 Super L

Capacity of center bowl	5.8 U.S. quarts (5.5 litres)
Capacity of planetary (each)	0.75 U.S. quart (0.7 litres)
Type of oil	Case Wet Brake Lubricant® (MS 1317)

Front Axle - Four Wheel Drive - 590 Super L

Capacity of center bowl	6.9 U.S. quarts (6.5 litres)
Capacity of planetary (each)	1.05 U.S. quarts (1.0 litres)
Type of oil	Case Wet Brake Lubricant® (MS 1317)

Rear Axle - 580L and 580 Super L

Capacity of center bowl	15 U.S. quarts (14.2 litres)
Capacity of planetary (each)	1.6 U.S. quarts (1.5 litres)
Type of oil - Axle No. 114367A2 and 114367A3	Case Wet Brake Lubricant® (MS 1317)
Type of oil - Axle No. 114367A4 and After	Case Hy-Tran Plus® (MS 1207)

Rear Axle - 590 Super L

Capacity of center bowl	15 U.S. quarts (14.2 litres)
Capacity of planetary (each)	2.1 U.S. quarts (2.00 litres)
Type of oil - Axle No. 127599A2	Case Wet Brake Lubricant® (MS 1317)
Type of oil - Axle No. 127599A3 and After	Case Hy-Tran Plus® (MS 1207)

Brake Reservoir (Gets fluid automatically from the hydraulic system)

Conversion Formulas

Imperial quart = litres x 0.879877

Imperial gallon = litres x 0.219969

ENGINE OIL RECOMMENDATIONS

Case IH No.1 Engine Oil is recommended for use in your Case IH Engine. Case IH No.1 Engine Oil will lubricate your engine correctly under all operating conditions. If Case IH No. 1 Multi-Viscosity Engine Oil is not available, Case IH No. 1 Single Grade Engine Oil can be used.

If Case IH No.1 Multi-Viscosity or Single Grade Engine Oil is not available, use only oil meeting API engine oil service category CE.

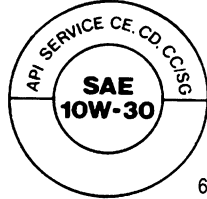

654L9

See the chart below for recommended viscosity at ambient air temperature ranges.

NOTE: Do not put Performance Additives or other oil additive products in the engine crankcase. The oil intervals given in this manual are according to tests with Case IH lubricants.



A27273

AMBIENT AIR TEMPERATURE RANGES

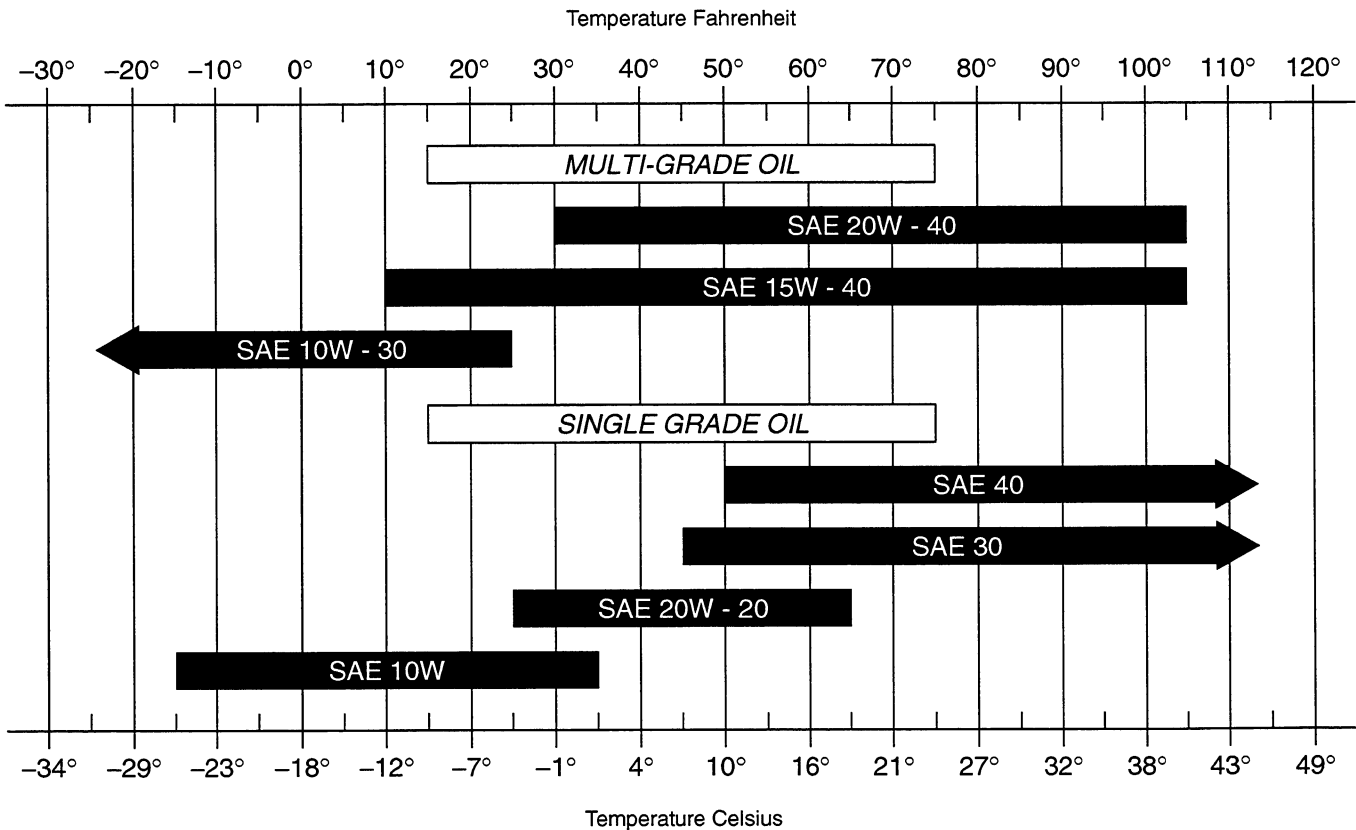

DIESEL FUEL

Use No. 2 diesel fuel in the engine of this machine. The use of other fuels can cause the loss of engine power and high fuel consumption.

In very cold temperatures, a mixture of No. 1 and No. 2 diesel fuels is temporarily permitted. See the following Note.

NOTE: See your fuel dealer for winter fuel requirements in your area. If the temperature of the fuel is below the cloud point (wax appearance point), wax crystals in the fuel will cause the engine to lose power or not start.

The diesel fuel used in this machine must meet the specifications in the chart below or Specification D975-81 of the American Society for Testing and Materials.

Specifications for Acceptable No. 2 Diesel Fuel

API gravity, minimum	34
Flash Point, Minimum	140°F (60°C)
Cloud point (wax appearance point), maximum	-5° F (-20° C) See Note above
Pour point, maximum	-15° F (-26° C) See Note above
Viscosity, at 100° F (88° C)	
Centistokes	2.0 to 4.3
Saybolt Seconds Universal	32 to 40

Fuel Storage

If you keep fuel in storage for a period of time, you can get foreign material or water in the fuel storage tank. Many engine problems are caused by water in the fuel.

Keep the fuel storage tank outside and keep the fuel as cool as possible. Remove water from the storage container at regular periods of time.

SECTION INDEX - ENGINES

Section Title	Section Number
Engine and Radiator Removal and Installation	2000
Stall Tests	2002
Specification Details.....	2402
Aftercooler	2411
Cylinder Head and Valve Train.....	2415
Cylinder Block.....	2425
Lubrication System	2445
Cooling System	2455
Turbocharger	2465
Turbocharger Failure Analysis	2565

CASE CORPORATION
700 STATE STREET
RACINE, WI 53404 U.S.A.

CASE CANADA CORPORATION
3350 SOUTH SERVICE ROAD
BURLINGTON, ON L7N 3M6 CANADA

Bur 7-48870

Copyright © 1995 Case Corporation
Printed in U.S.A.
Issued May 1995

Section 2000

ENGINE AND RADIATOR REMOVAL AND INSTALLATION

CASE CORPORATION
700 STATE STREET
RACINE, WI 53404 U.S.A.

CASE CANADA CORPORATION
3350 SOUTH SERVICE ROAD
BURLINGTON, ON L7N 3M6 CANADA

Bur 7-49650

Copyright © 1995 Case Corporation
Printed in U.S.A.
Issued May 1995

2000

RADIATOR REMOVAL

Put identification tags on all disconnected hoses and wires. Close disconnected hoses and fittings with caps and plugs.

STEP 1

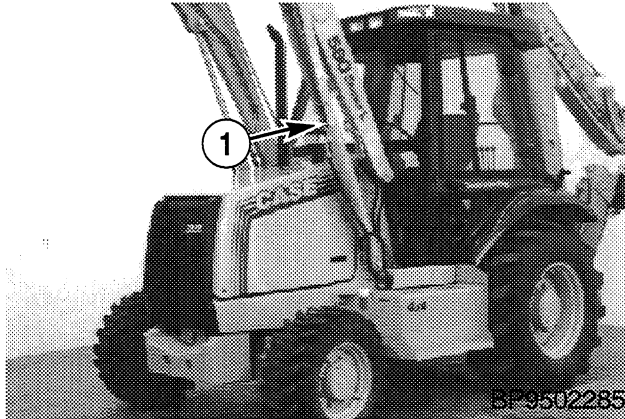

Park the machine on a level surface. Raise the loader and lock the support strut (1) to hold the loader.

STEP 2

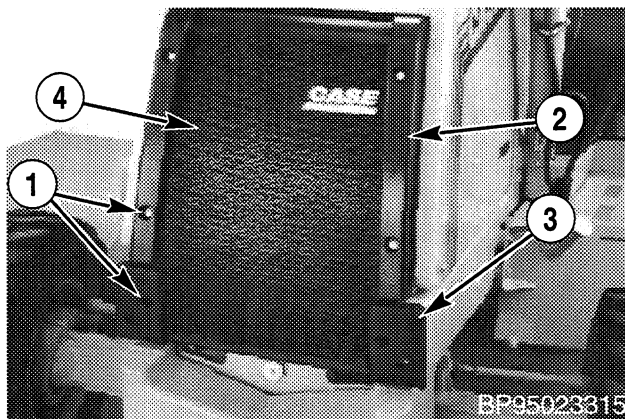

Remove the caps screws (1), upper (2) and lower bumpers (3), and the grille (4) from the front of the machine.

STEP 3

Remove the bolts, washers, and nuts from the pivot point on the hood.

STEP 4

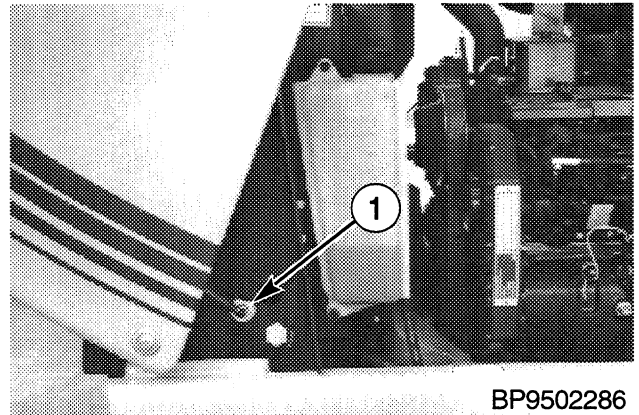

BP9502286

Have another person help with the following procedure.

- A. Open the hood.
- B. Remove the retainers from the hood struts (1) and disconnect the hood struts from the stud.
- C. Hold the hood in place and disconnect the hood cable from the radiator shroud on the other side of the machine.
- D. Carefully lower the hood back to the closed position.

STEP 5

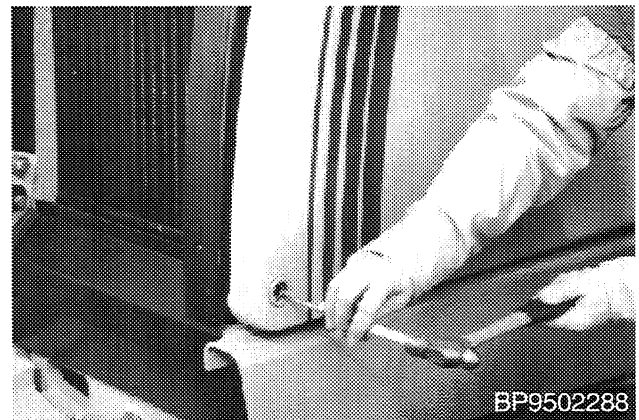

BP9502288

Drive the pivot tubes out of the hood pivot point. Remove the hood from the machine.

STEP 6

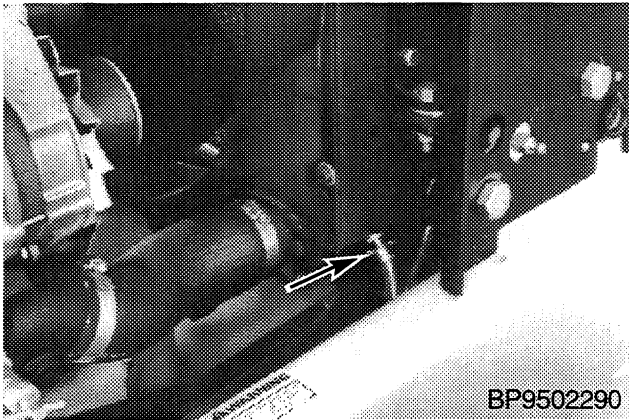

Slowly remove the radiator cap. Install a hose on the drain valve and drain the radiator into a clean container that holds approximately 18 U.S. quarts (17 litres).

NOTE: During installation, fill the radiator and coolant reservoir completely. See Section 1002 for coolant specifications. Start and run the engine until the coolant is at operating temperature. Stop the engine and check for leakage. When the coolant is cold, check the coolant reservoir level. Add coolant as required.

STEP 7

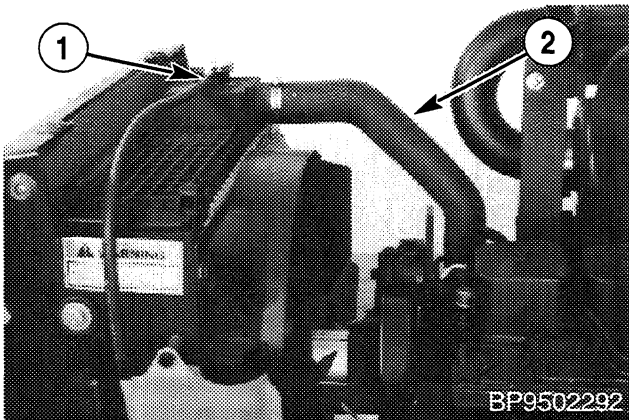

Disconnect the overflow hose (1) from the radiator neck. Loosen the clamp and disconnect the upper radiator hose (2).

STEP 8

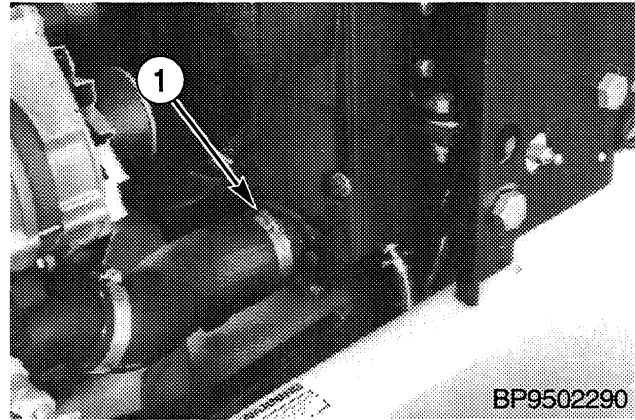

Loosen the clamp (1) and disconnect the lower radiator hose.

STEP 9

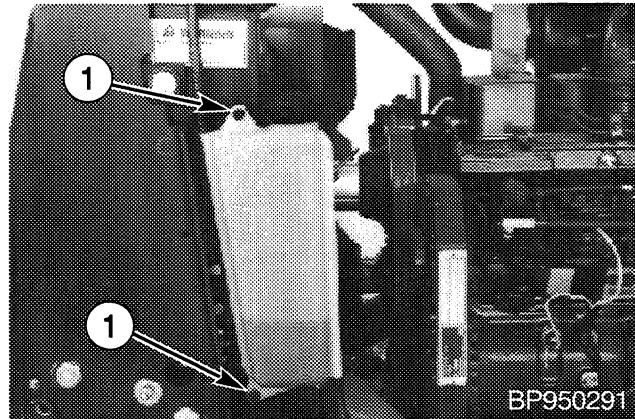

Remove the bolts (1), spacers, washers, and coolant reservoir from the machine.

STEP 10

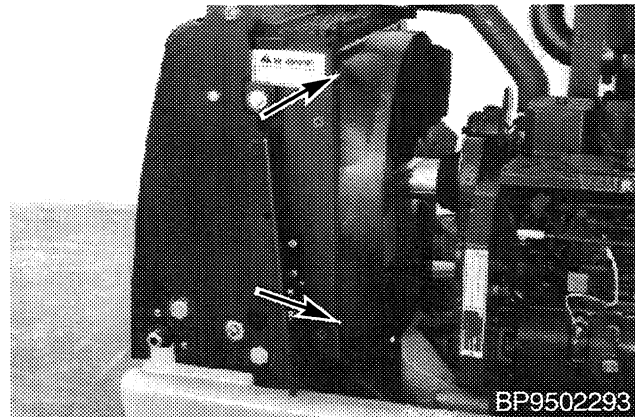

Remove the hardware from the fan shroud. Move the fan shroud away from the radiator.

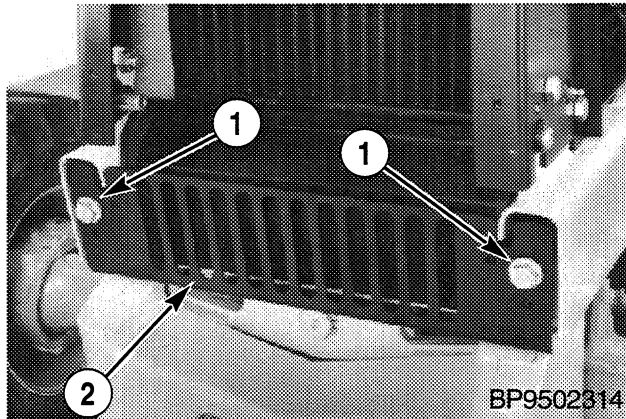
STEP 11

Remove the cap screws (1) and pump guard (2) from the machine.

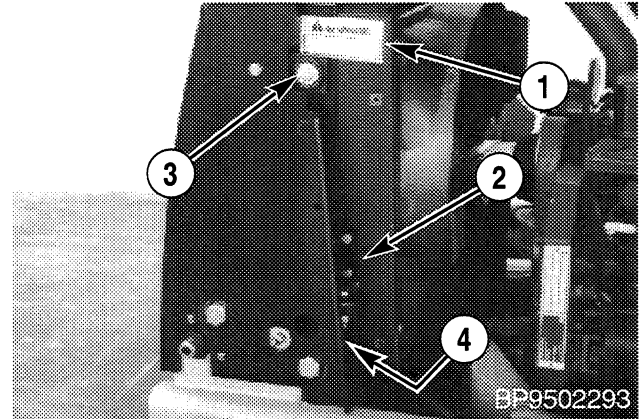
STEP 12

Use a sharp knife and cut the warning decal (1). Remove the cap screws that fasten the lower brackets (2) to the radiator. Remove the hardware and the lower brackets (2) from the radiator shroud. Remove the cap screws and flat washers that fasten the upper brackets (3) to the radiator. Remove the cap screws and flat washers (4) that fastens the condenser if equipped and oil cooler to the radiator. Lift the radiator straight up and remove the radiator from the machine

NOTE: *Installation of the radiator is the reverse of removal.*

ENGINE REMOVAL

Put identification tags on all disconnected hoses and wires. Close disconnected hoses and fittings with caps and plugs.

STEP 1



Park the machine on a level surface. Raise the loader and lock the support strut to hold the loader.

STEP 2

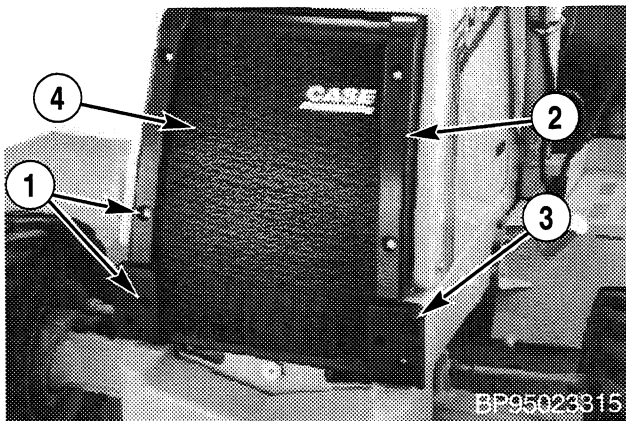

Remove the caps screws (1), upper (2) and lower bumpers (3), and the grille (4) from the front of the machine.

STEP 3

Remove the bolts, washers, and nuts from the pivot point on the hood.

STEP 4

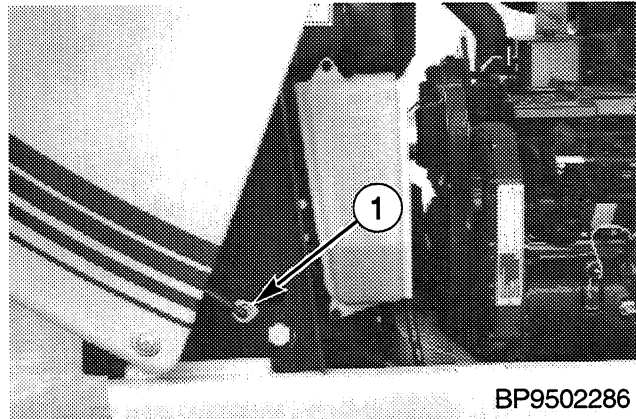

Have another person help with the following procedure.

- E. Open the hood.
- F. Remove the retainers from the hood struts (1) and disconnect the hood struts from the stud.
- G. Hold the hood in place and disconnect the hood cable from the radiator shroud on the other side of the machine.
- H. Carefully lower the hood back to the closed position.

STEP 5

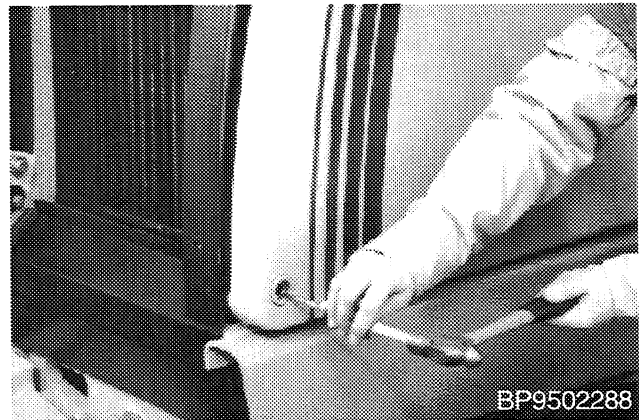

Drive the pivot tubes out of the hood pivot point. Remove the hood from the machine.

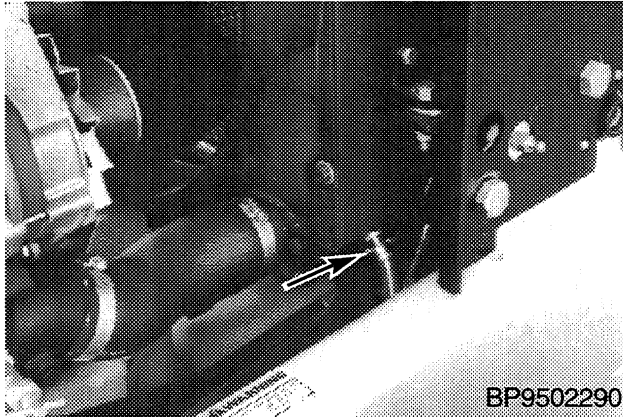
STEP 6

Slowly remove the radiator cap. Install a hose on the drain valve and drain the radiator into a clean container that holds approximately 18 U.S. quarts (17 litres).

NOTE: During installation, fill the radiator and coolant reservoir completely with coolant. See Section 1002 for coolant specifications. Start and run the engine until the coolant is at operating temperature. Stop the engine and check for leakage. When the coolant is cold, check the coolant reservoir level. Add coolant as required.

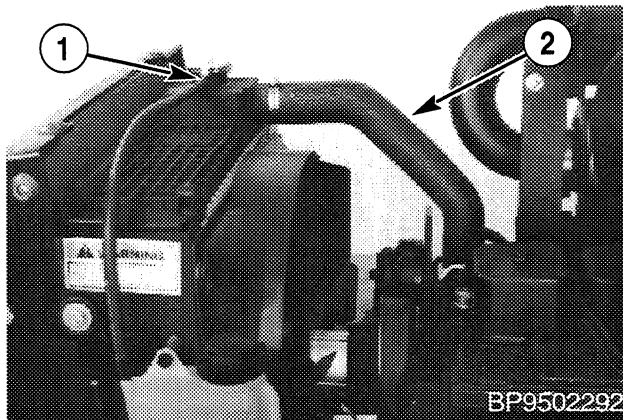
STEP 7

Disconnect the overflow hose (1) from the radiator neck. Loosen the clamp and disconnect the upper radiator hose (2).

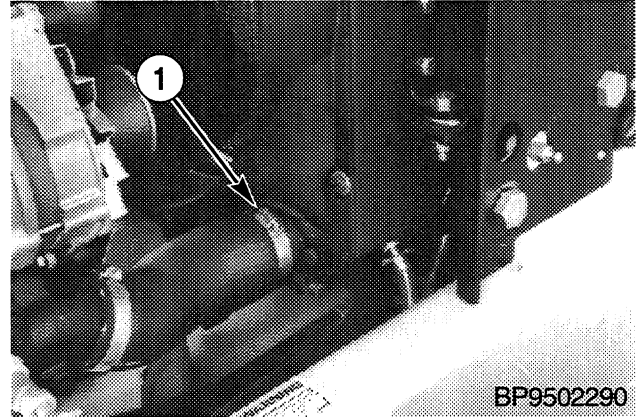
STEP 8

Loosen the clamp (1) and disconnect the lower radiator hose.

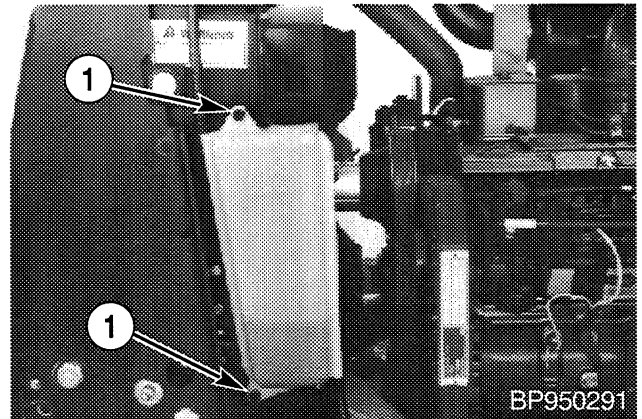
STEP 9

Remove the bolts (1), spacers, washers, and coolant reservoir from the machine.

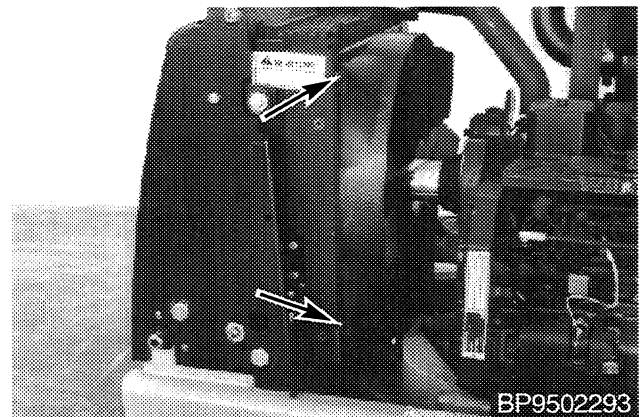
STEP 10

Remove the hardware from the fan shroud. Move the fan shroud away from the radiator.

STEP 11

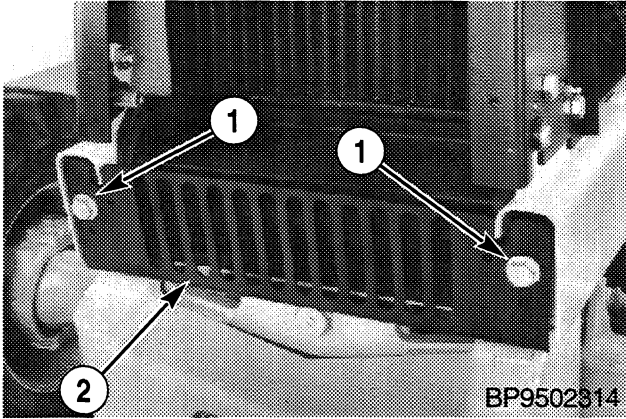

Remove the cap screws (1) and pump guard (2) from the machine.

NOTE: If the machine is equipped with air conditioning and a baffle plate with a slot for the drier hose, go to step 21. If the machine is equipped with air conditioning and a baffle plate with out a slot for the drier hose, do steps 17 through 19 to keep from discharging the air conditioning system. For machines without air conditioning, do steps 12 through 16.

STEP 12

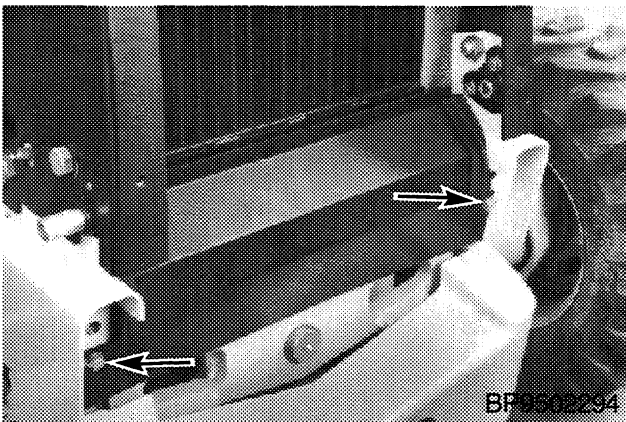

Loosen and remove the cap screws, flat washers, and if equipped, lock washers that fasten the baffle plate to the front of the machine.

STEP 13

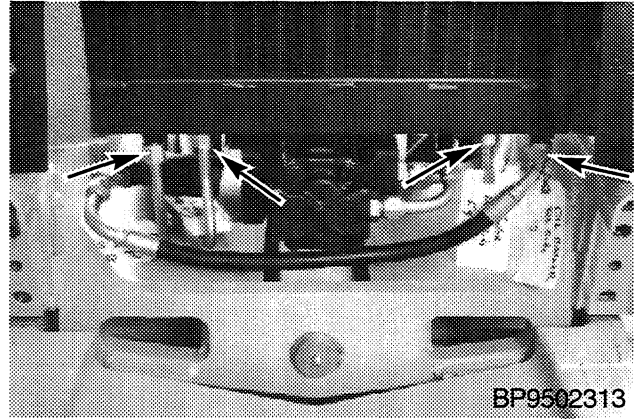

Disconnect the hoses from the oil cooler.

STEP 14

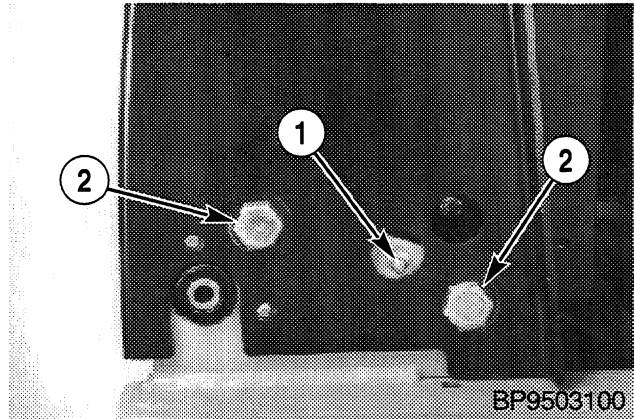

Remove the studs (1). Remove the bolts (2) and nuts that fasten the radiator shroud to the frame.

STEP 15

Remove the radiator shroud, radiator, and oil cooler as an assembly.

STEP 16

Go to step 31.

NOTE: Do steps 17 through 19 for machine with air conditioning and a baffle plate without a slot.

STEP 17

Remove all straps that hold the hose for the air conditioning system drier from the front of the machine back to the cab. It is important to have as much hose as possible at the front of the machine to do the next step.

STEP 18

Loosen and remove the cap screws, flat washers, and if equipped, lock washers that fasten the baffle plate to the front of the machine.

STEP 19

Move the baffle plate and drier for access to the hoses on the left side of the oil cooler.

STEP 20

Go to Step 24.

NOTE: Do steps 21 and 22 for machines with air conditioning and a baffle plate with a slot.

STEP 21

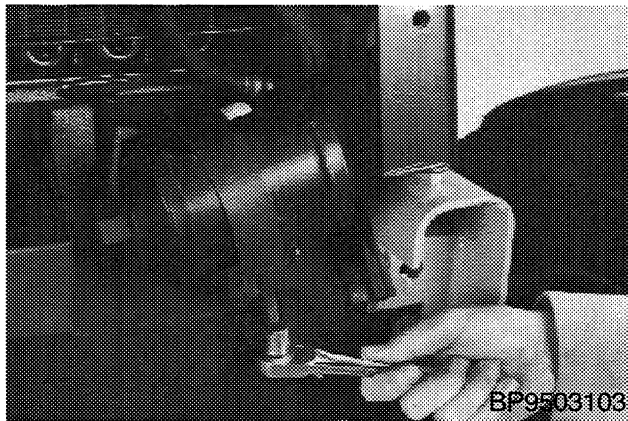

Remove the self-locking nut and clamp from the drier.

STEP 22

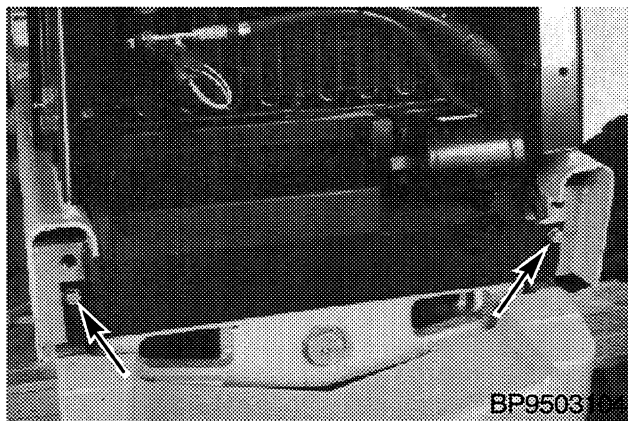

Remove the cap screws, flat washers, and if equipped, lock washers that fasten the baffle plate to the front of the machine. Remove the baffle plate from the drier and the machine.

NOTE: Do the remaining steps for all machines.

STEP 23

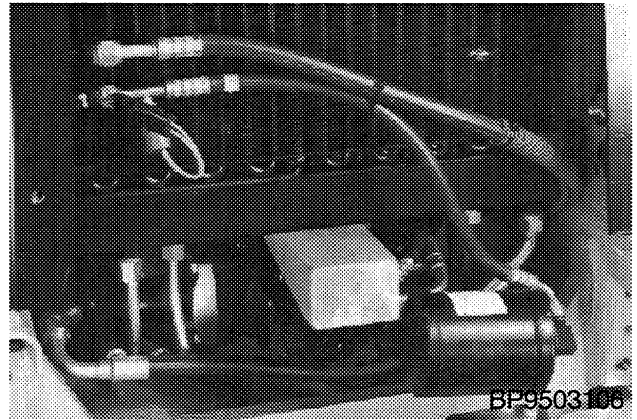

Put a block under the oil cooler to hold the radiator, oil cooler, and condenser in place when the radiator shroud is removed.

STEP 24

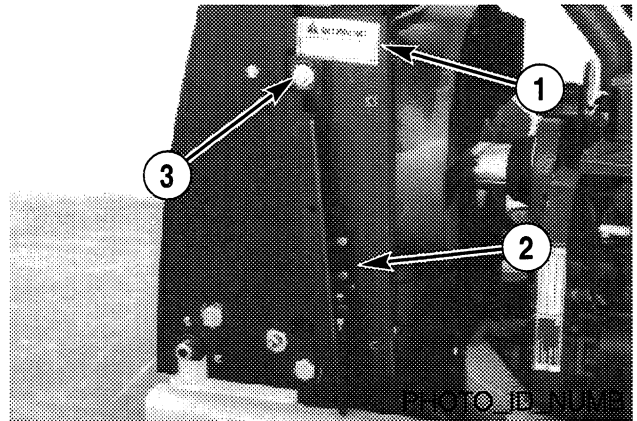

Use a sharp knife and cut the warning decal (1). Remove the cap screws that fasten the lower brackets (2) to the radiator. Remove the hardware and the lower brackets (2) from the radiator shroud. Remove the cap screws and flat washers that fasten the upper brackets (3) to the radiator.

STEP 25

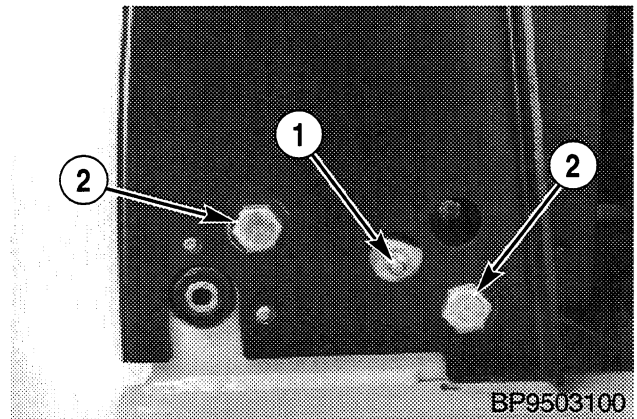

Remove the studs (1) from the frame. Remove the bolts and nuts (2) that fasten the radiator shroud to the frame.

STEP 26

Remove the radiator shroud from the radiator, oil cooler, and condenser.

STEP 27

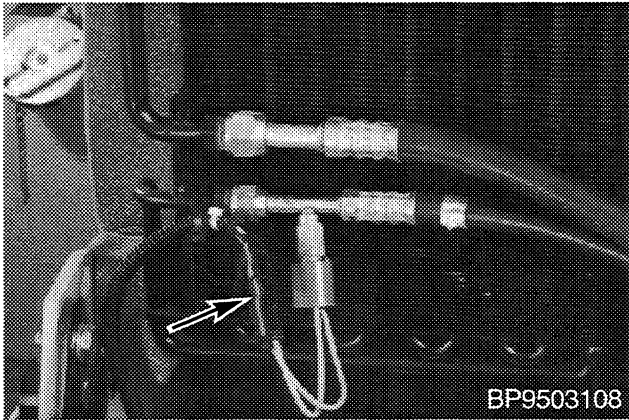

Disconnect the electrical connector for the drier.

STEP 28

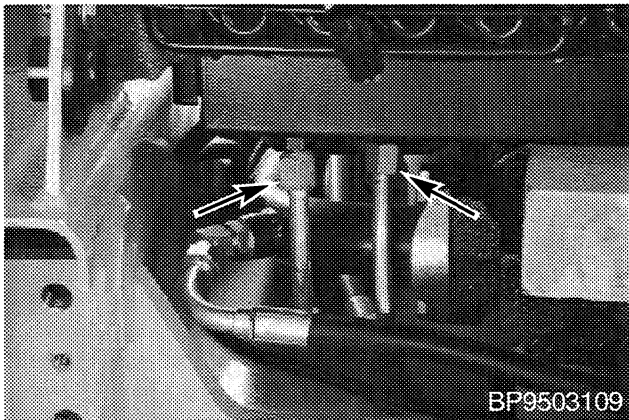

Disconnect the hoses from the oil cooler on both sides of the oil cooler.

STEP 29

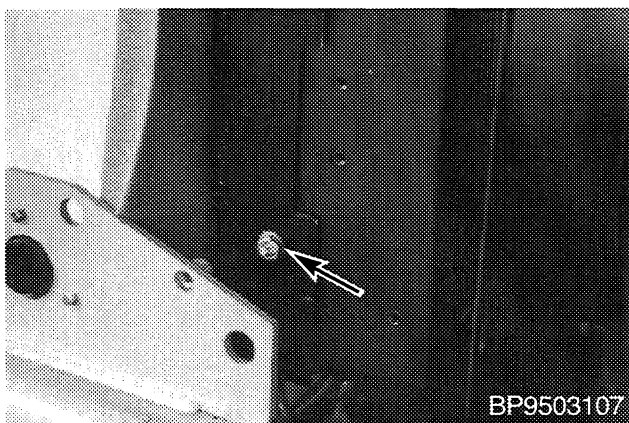

Remove the cap screws and flat washers that fasten the condenser and oil cooler to the radiator.

STEP 30

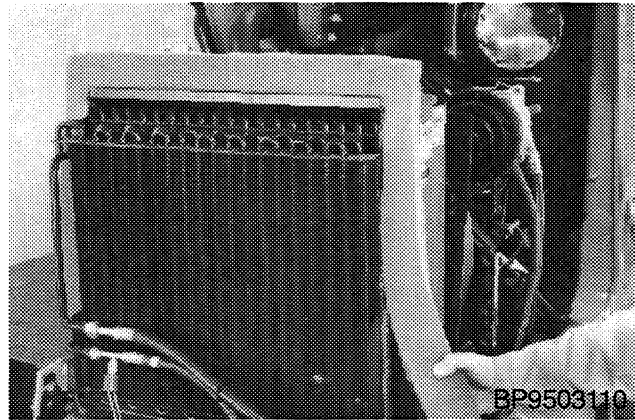

Pull the foam baffle away from the condenser.

STEP 31



For machines with a slot in the baffle plate, move the condenser and drier assembly out of the way as shown. For machines without a slot in the baffle plate, have another person help to move the condenser, baffle plate, and drier assembly away from the radiator and oil cooler assembly and fasten the assembly out of the way.

STEP 32

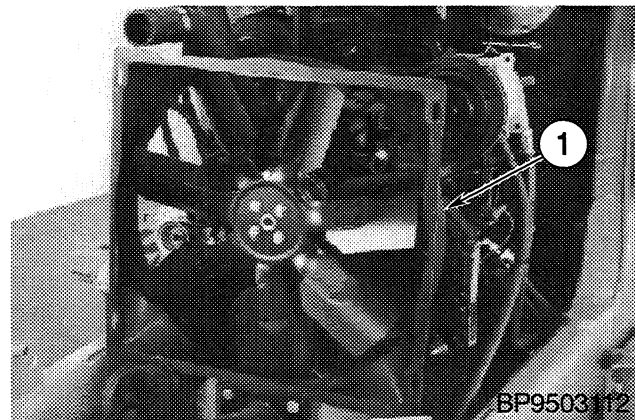

Remove the radiator and oil cooler. Remove the fan shroud (1) from the fan.

STEP 33

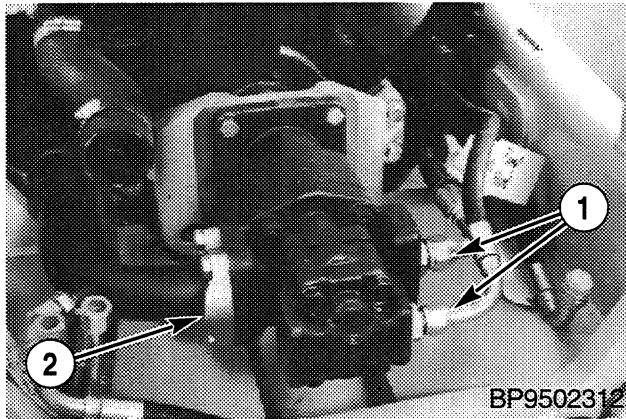

Disconnect the hoses (1) from the LH side of the pump. Remove the bolts and lock washers that fasten the flange (2) on the RH side of the pump.

STEP 34

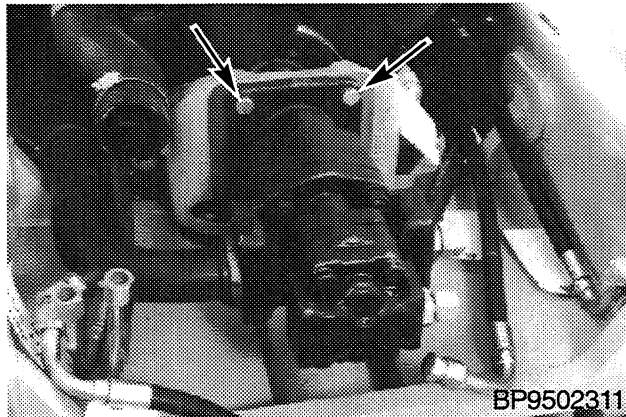

Loosen and remove the cap screws that fasten the pump to the pump mounting bracket.

NOTE: Do steps 35 through 37 for machines with air conditioning.

STEP 35

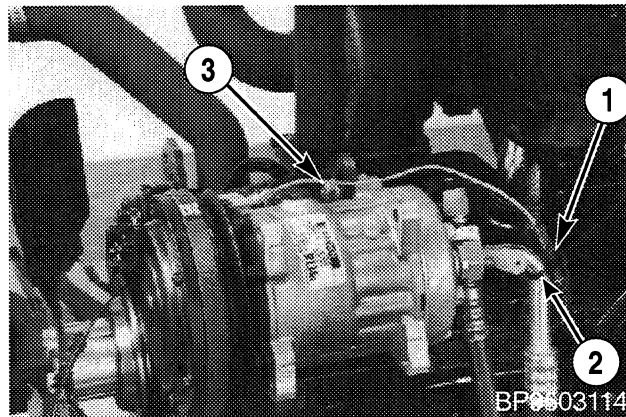

Disconnect the electrical connector (1). Remove the tie strap (2). Remove the hardware (3) from the adjusting straps

STEP 36

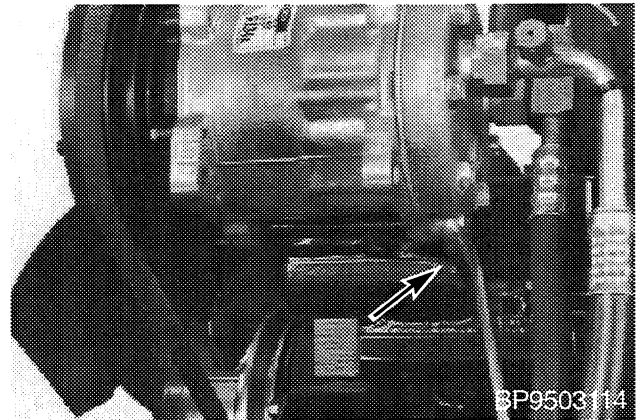

Remove the hardware that fastens the compressor to the bracket.

STEP 37

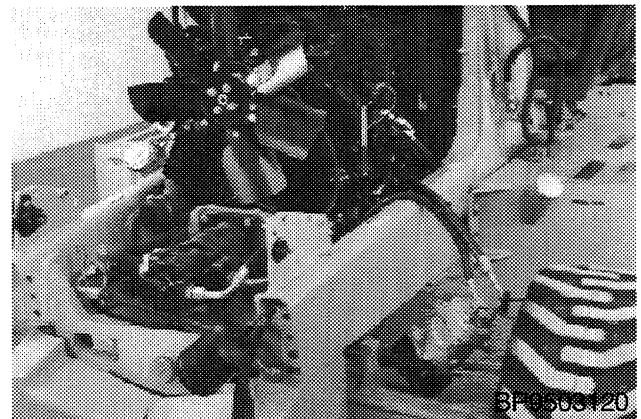

Remove the belt and lay the compressor over the side of the frame

NOTE: During installation, adjust the drive belt according the instructions in Section 9003.

STEP 38

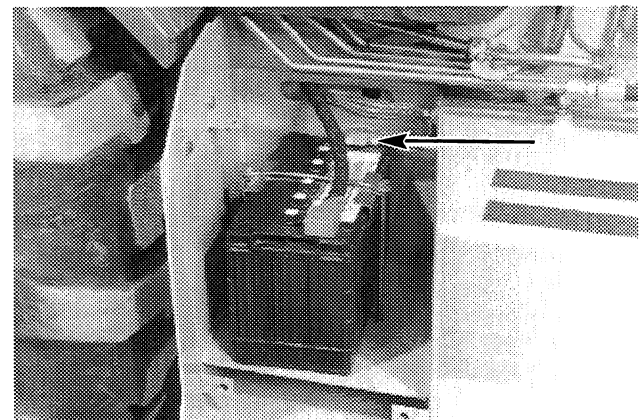

Remove the battery cover from the right step. If the machine has only one battery, disconnect the negative battery cable from the battery.

STEP 39

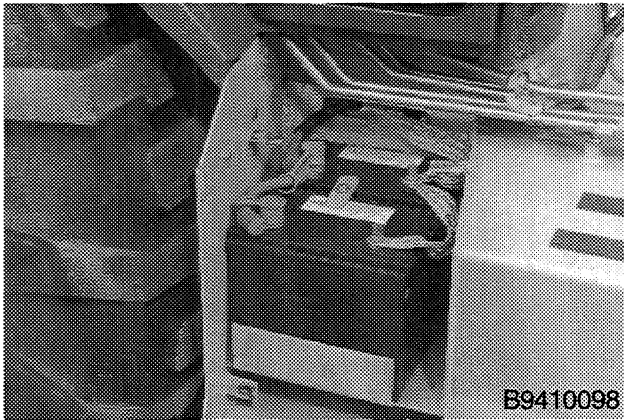

If the machine has two batteries, remove the terminal nut. Remove the negative battery cable from the terminal and move the negative battery cable away from the battery. Make sure the jumper cable is installed on the terminal and start the terminal nut onto the terminal.

STEP 40

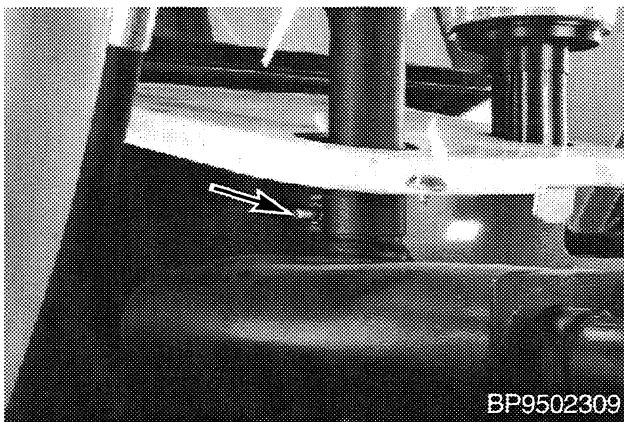

Loosen the clamp for the exhaust pipe at the muffler. Remove the exhaust pipe from the muffler.

STEP 41

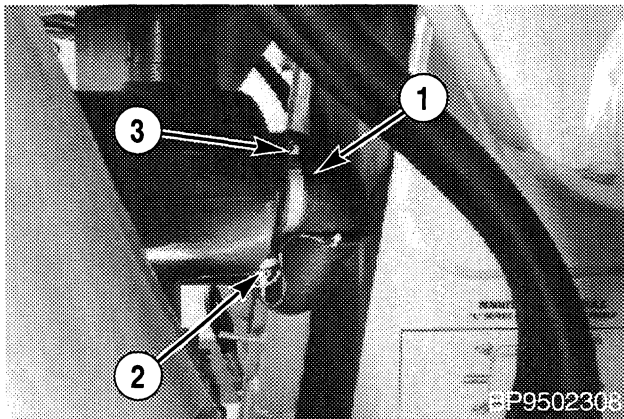

Remove the tie strap (1). Disconnect the electrical connectors (2) for the air restriction indicator. Loosen the clamp (3) on the air cleaner hose. Disconnect the hose from the air cleaner.

STEP 42

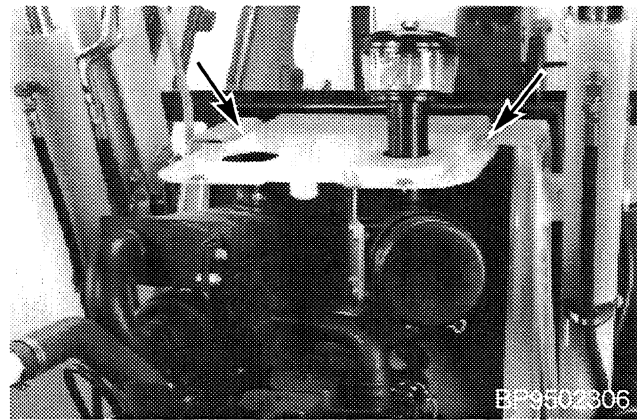

Remove the cap screws and flat washers that fasten the cover to uprights. Remove the cover and air cleaner as an assembly.

STEP 43

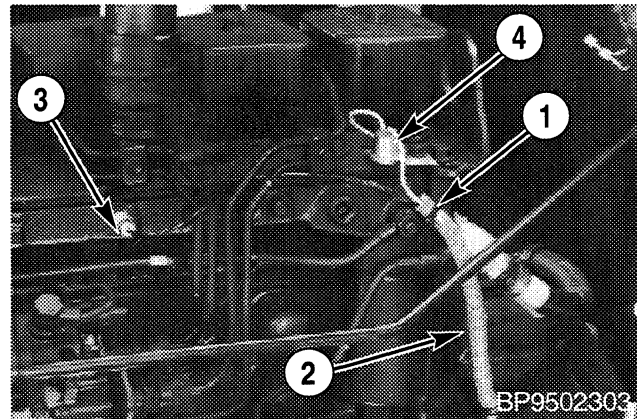

If the machine has ether injection, remove the tie straps (1) and sleeve (2) from the tube (3) and wire (4). Disconnect the tube (3) and the wire (4).

STEP 44

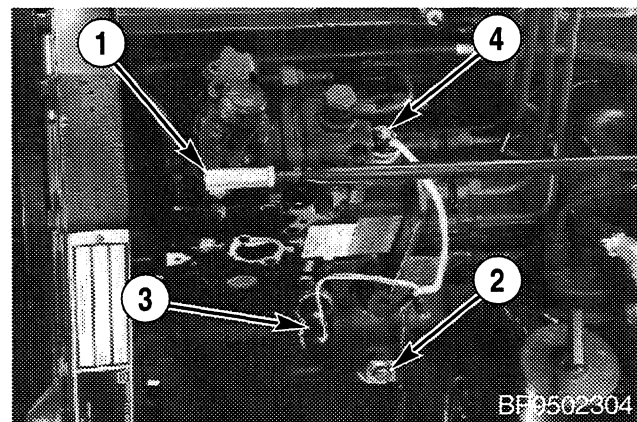

Disconnect the throttle rod (1). Disconnect the wiring clamp (2). Disconnect the wire from the oil pressure sender (3). Disconnect the fuel shutoff wire (4).

STEP 45

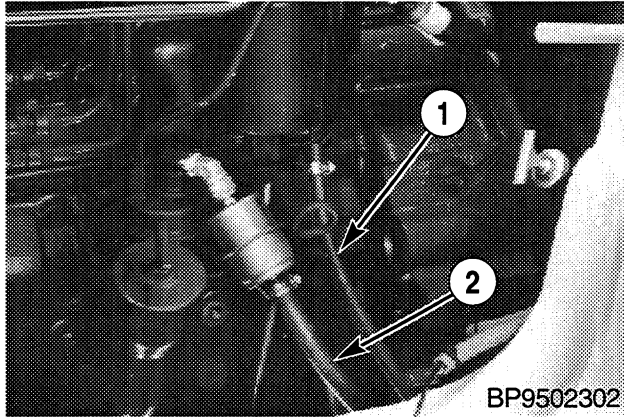

Disconnect the fuel lines (1) and (2).

STEP 48

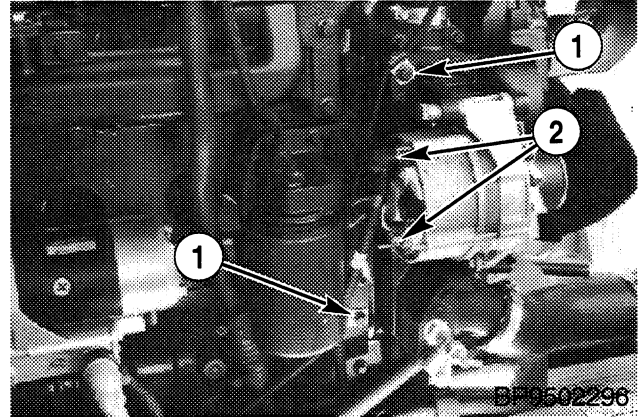

Remove the harness clamps (1). Disconnect the wires (2) from the alternator.

STEP 46

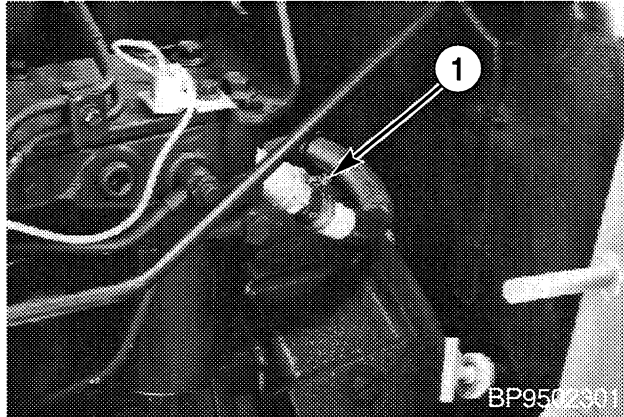

Disconnect the heater hose (1).

STEP 49

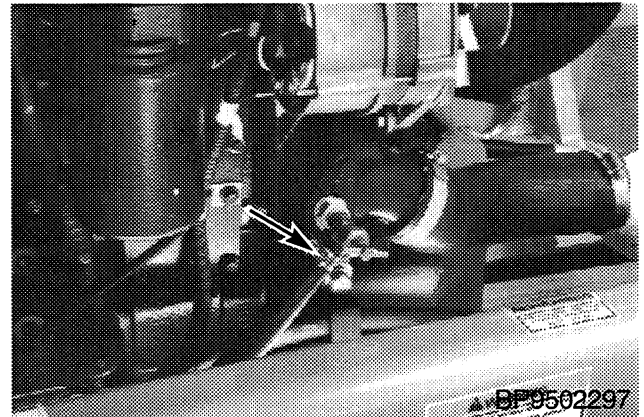

Loosen the clamp and disconnect the heater hose.

STEP 47

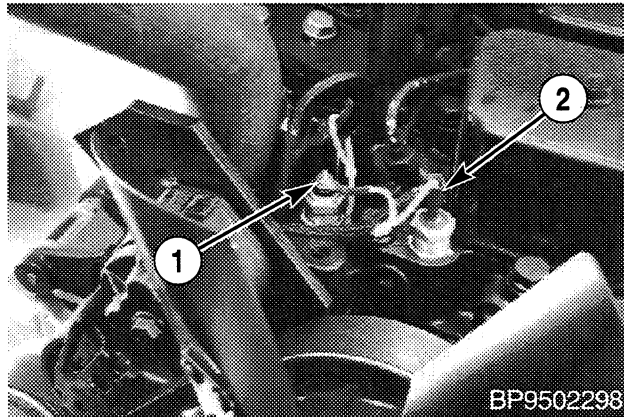

Disconnect the coolant temperature sender (1) and coolant temperature switch (2).

STEP 50

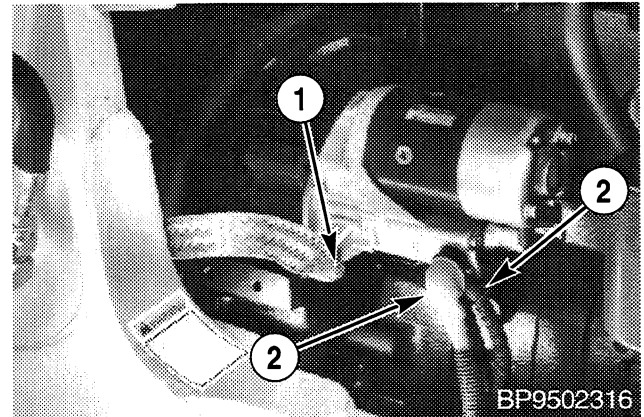

Disconnect the ground strap (1). Disconnect the wires (2) from the starter.

STEP 51

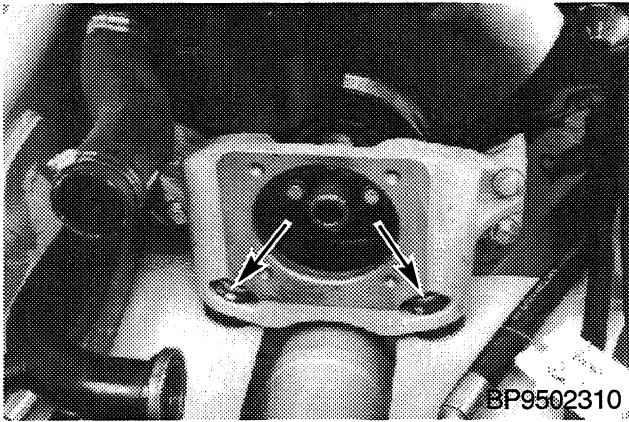

Remove the bolts, flat washers, and nuts from the front engine mount.

NOTE: During installation, tighten the self-locking nuts to 360 to 420 pound-inches (41 to 47 Nm).

STEP 52

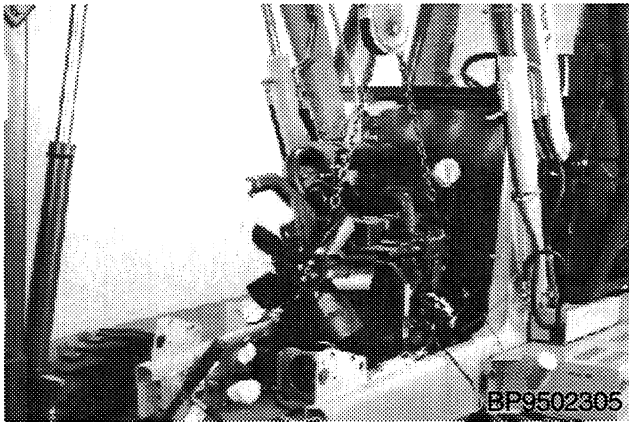

Connect lifting equipment to the lifting eyes on the engine to hold the engine in place.

NOTE: There are six cap screws with lock washers that fasten the torque converter to the flywheel. The engine must be rotated to align each cap screw with the access hole in the flywheel housing at the left side of the engine.

STEP 53

Remove the plastic plug from the flywheel housing. Remove the hose from the bracket and remove the cover and gasket from the access hole for the cap screws

STEP 54

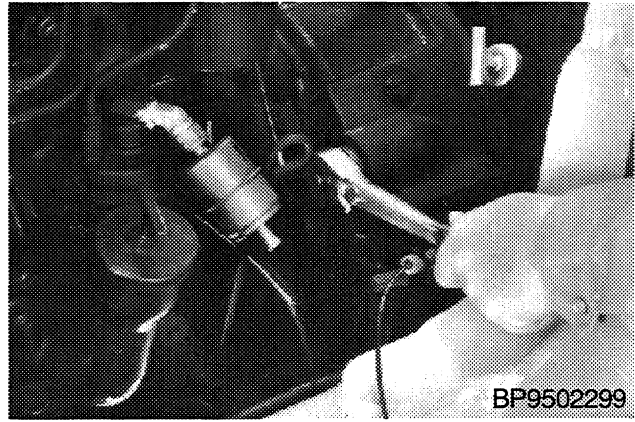

Install the CAS-1690 tool to turn the flywheel for access to the cap screws.

STEP 55

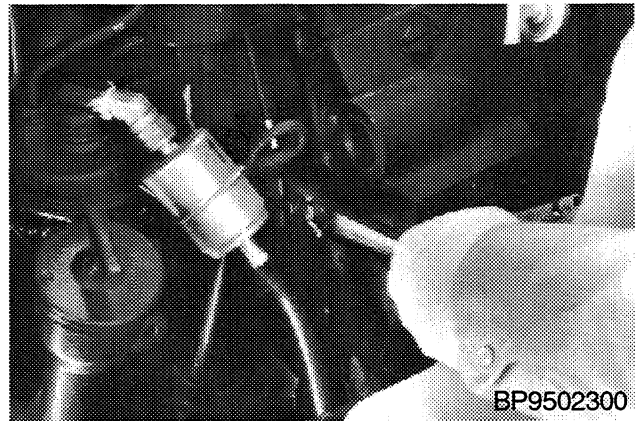

Loosen and remove all six cap screws and lock washers that fasten the torque converter to the flywheel.

NOTE: Be careful during installation when installing the cap screws and lock washers that fasten the torque converter to the flywheel. Tighten the cap screws to 38 to 42 pound-feet (52 to 57 Nm).

STEP 56

Loosen and remove the 12 cap screws and flat washers that fasten the transmission to the engine. Move the heater hose and clamps out of the way.

STEP 57

Move the engine forward and raise the engine. Remove the engine from the machine.

NOTE: *Installation of the engine is the reverse of removal. Before starting the engine, do the following:*

1. The turbocharger must be filled with oil. Disconnect the wire from the fuel shutoff solenoid. Actuate the starter for 10 to 20 seconds to fill the turbocharger with oil. Connect the wire to the fuel shutoff solenoid.
2. The hydraulic pump **must** be filled with oil. Do the following procedure to fill the hydraulic pump with oil:
 - A. Make sure the oil level in the hydraulic reservoir is correct.
 - B. Remove the cap from the hydraulic reservoir.
 - C. Use a nozzle and shop air to pressurize the hydraulic reservoir. Wrap a shop cloth around the end of the hose at the nozzle.

NOTE: *5 psi (34.5 kPa) to 10 psi (69.0 kPa) is all that is required to move the oil. Pressure above 10 psi (69.0 kPa) can damage the hydraulic reservoir.*

- D. Have another person start and run the engine at low idle while shop air is being applied to the hydraulic reservoir.

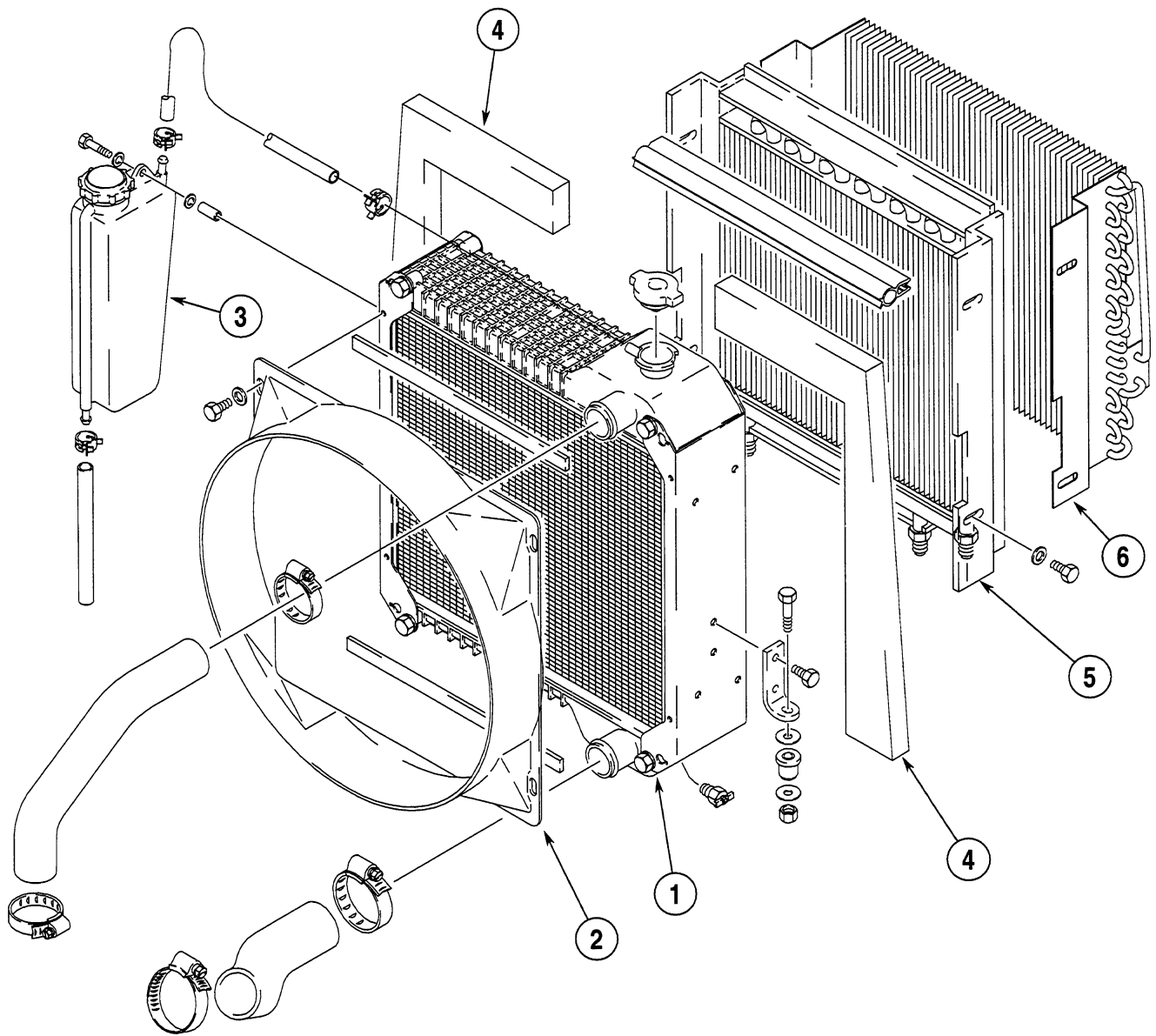

1. Radiator
2. Fan Shroud

3. Coolant Recovery Bottle
4. Baffle

5. Oil Cooler
6. Air Conditioning Condenser

Radiator Installation

B9503081T



Suggest:

If the above button click is invalid.

Please download this document

first, and then click the above link

to download the complete manual.

Thank you so much for reading

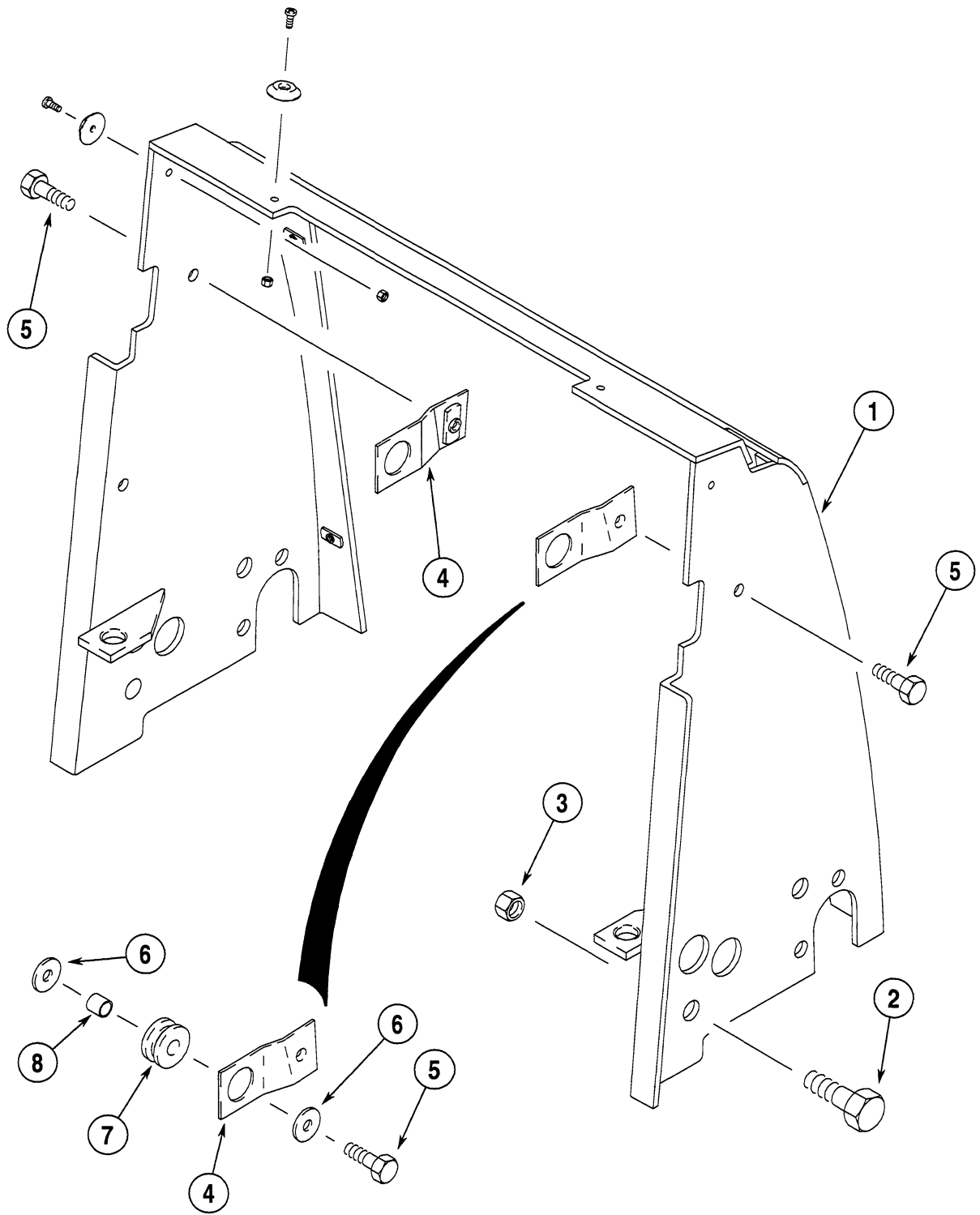

1. Radiator Shroud
2. Bolt, Radiator Shroud
to Chassis Frame

3. Nut
4. Bracket, Radiator
Shroud to Radiator

5. Cap Screw
6. Flat Washer, Special

7. Grommet
8. Spacer

Radiator Shroud

B9503082T

<https://www.ebooklibonline.com>

Hello dear friend!

Thank you very much for reading.

Enter the link into your browser.

The full manual is available for immediate download.

<https://www.ebooklibonline.com>