

Bobcat®

Service Manual

G Series

(S/N 512250001 & Above)
(S/N 512450001 & Above)
(S/N 512620001 & Above)

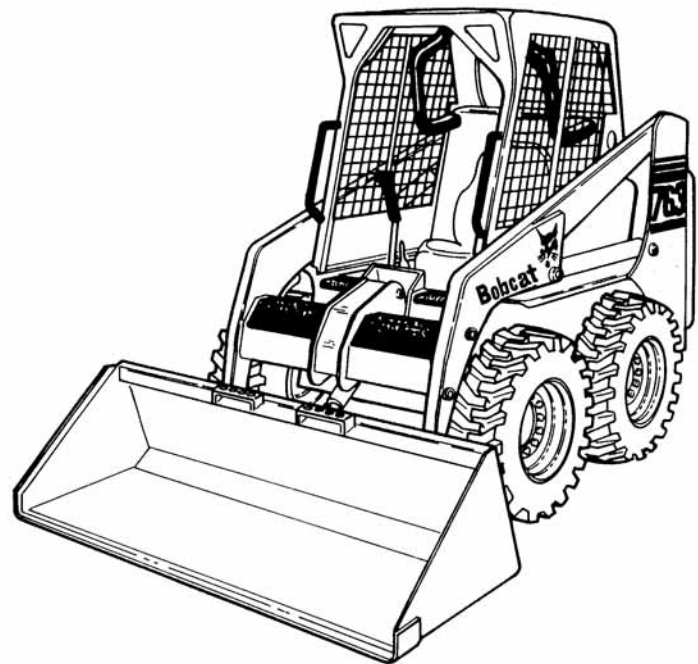

EQUIPPED WITH
BOBCAT INTERLOCK
CONTROL SYSTEM (BICS™)

MAINTENANCE SAFETY



WARNING

Instructions are necessary before operating or servicing machine. Read and understand the Operation & Maintenance Manual, Operator's Handbook and signs (decals) on machine. Follow warnings and instructions in the manuals when making repairs, adjustments or servicing. Check for correct function after adjustments, repairs or service. Untrained operators and failure to follow instructions can cause injury or death.

W-2003-0903



Safety Alert Symbol: This symbol with a warning statement, means: "Warning, be alert! Your safety is involved!" Carefully read the message that follows.

CORRECT

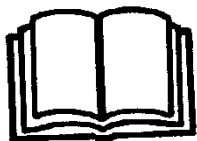

B-10731a

Never service the Bobcat Skid-Steer Loader without instructions.

CORRECT

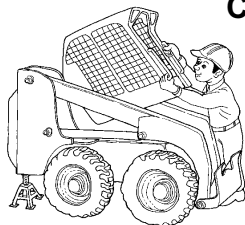

B-15590

Use the correct procedure to lift or lower operator cab.

CORRECT

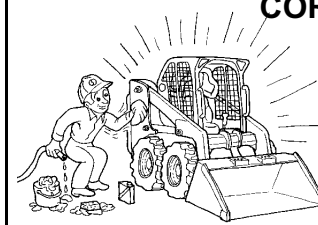

B-15591

Cleaning and maintenance are required daily.

WRONG

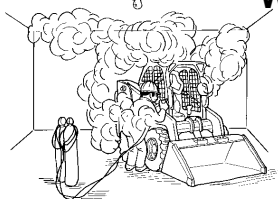

B-15592

- Have good ventilation when welding or grinding painted parts.
- Wear dust mask when grinding painted parts. Toxic dust and gas can be produced.
- Avoid exhaust fume leaks which can kill without warning. Exhaust system must be tightly sealed.

WRONG

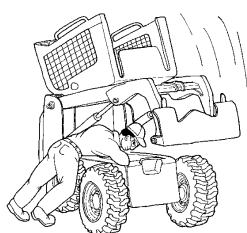

B-15593

Disconnecting or loosening any hydraulic tubeline, hose, fitting, component or a part failure can cause lift arms to drop. Do not go under lift arms when raised unless supported by an approved lift arm support device. Replace it if damaged.

WRONG

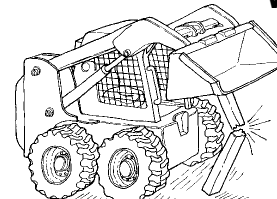

B-15599

- Never work on loader with lift arms up unless lift arms are held by an approved lift arm support device. Replace if damaged.
- Never modify equipment or add attachments not approved by Bobcat Company.

WRONG

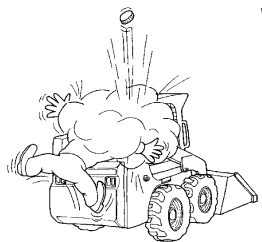

B-15600

- Stop, cool and clean engine of flammable materials before checking fluids.
- Never service or adjust loader with the engine running unless instructed to do so in the manual.
- Avoid contact with leaking hydraulic fluid or diesel fuel under pressure. It can penetrate the skin or eyes.
- Never fill fuel tank with engine running, while smoking or when near open flame.

WRONG

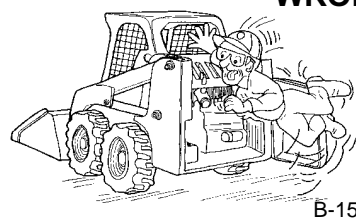

B-15601

- Keep body, jewelry and clothing away from moving parts, electrical contact, hot parts and exhaust.
- Wear eye protection to guard from battery acid, compressed springs, fluids under pressure and flying debris when engines are running or tools are used. Use eye protection approved for type of welding.
- Keep rear door closed except for service. Close and latch door before operating the loader.

WRONG



B-6589

- Lead-acid batteries produce flammable and explosive gases.
- Keep arcs, sparks, flames and lighted tobacco away from batteries.
- Batteries contain acid which burns eyes or skin on contact. Wear protective clothing. If acid contacts body, flush well with water. For eye contact flush well and get immediate medical attention.

Maintenance procedures which are given in the Operation & Maintenance Manual can be performed by the owner/operator without any specific technical training. Maintenance procedures which are **not** in the Operation & Maintenance Manual must be performed **ONLY BY QUALIFIED BOBCAT SERVICE PERSONNEL**. Always use genuine Bobcat replacement parts. The Service Safety Training Course is available from your Bobcat dealer.

ALPHABETICAL INDEX

ADVANCED CONTROL SYSTEM	60-01	HYDRAULIC/HYDROSTAIC	
ADVANCED HAND CONTROL SYSTEM	60-01	FLUID SPECIFICATIONS.....	SPEC-01
AIR CLEANER	70-01	HYDRAULIC PUMP	20-01
AIR CLEANER SERVICE	10-01	HYDRAULIC/HYDROSTATIC SYSTEM.....	10-01
ALTERNATOR	60-01	HYDRAULIC SYSTEM INFORMATION	20-01
		HYDROSTATIC MOTOR	30-01
BASCI TROUBLESHOOTING	80-01	HYDROSTATIC PUMP	30-01
BATTERY	60-01	HYDROSTATIC SYSTEM INFORMATION	30-01
BOBCAT INTERLOCK			
CONTROL SYSTEM (BICS™)	60-01	INSTRUMENT PANEL.....	60-01
BOB-TACH	10-01, 50-01		
BRAKE	40-01	LIFT ARM	50-01
BUCKET POSITION VALVE	20-01	LIFT ARM BY-PASS CONTROL VALVE.....	20-01
		LIFT ARM SUPPORT DEVICE	10-01
CHAINCASE	40-01	LIFTING AND BLOCKING THE LOADER.....	10-01
CHARGE PRESSURE.....	30-01	LIGHTS	60-01
COMPONENTS	80-01	LOADER SPECIFICATIONS	SPEC-01
CONTROL HANDLE	50-01	LUBRICATION OF THE BOBCAT LOADER	10-01
CONTROL PANEL	50-01		
CONTROL PEDALS	50-01		
CONVERSIONS	SPEC-01	MAIN RELIEF VALVE	20-01
COOLING FAN	70-01	MUFFLER.....	70-01
CYLINDER(S)	20-01		
		OIL COOLER.....	30-01
DIAGNOSTICS	60-01	OPERATOR CAB	10-01, 50-01
DRIVE BELT	30-01	OPERATOR SEAT	50-01
DRIVE COMPONENTS	40-01		
		POWER BOB-TACH BLOCK.....	20-01
ELECTRICAL/HYD. CONTROLS REFERENCE	60-01		
ELECTRICAL SYSTEM INFORMATION	60-01	REAR AXULIARY DIVERTER.....	20-01
ENGINE	70-01	REAR DOOR	50-01
ENGINE COMPONENTS AND TESTING	70-01	REAR GRILL	50-01
ENGINE COOLING SYSTEM.....	10-01	RECONDITIONING THE ENGINE	70-01
ENGINE LUBRICATION SYSTEM.....	10-01	REGULAR MAINTENANCE	80-01
ENGINE SPECIFICATIONS	SPEC-01	REMOTE START	10-01
ENGINE SPEED CONTROL	70-01	RPM SENSOR	70-01
FAN GEARBOX	10-01	SEAT BAR	50-01
FINAL DRIVE TRANSMISSION (CHAINCASE)	10-01	SEAT BAR SENSOR	60-01
FLYWHEEL AND HOUSING	70-01	SELECT VALVE.....	20-01
FRONT AUXILIARY PRESSURE RELIEF BLOCK	20-01	SERVICE SCHEDULE	10-01
FRONT AUXILIARY HYDRAULIC		SPARK ARRESTOR MUFFLER.....	10-01
COUPLER BLOCK	20-01	STARTER	60-01
FUEL SYSTEM	10-01	SYSTEM TROUBLESHOOTING CHART	80-01
FUEL TANK.....	50-01		
		TIRE MAINTENANCE	10-01
HEATER UNIT	80-01	TORQUE SPECIFICATIONS FOR BOLTS ...	SPEC-01
HEATER COIL	80-01	TOWING THE LOADER	10-01
HEATER FAN.....	80-01	TRACTION LOCK	60-01
HEATER VALVE.....	80-01	TRANSPORTING THE BOBCAT LOADER.....	10-01
HYDRAULIC CONNECTION SPECS	SPEC-01	TROUBLESHOOTING	70-01
HYDRAULIC CONTROL VALVE.....	20-01		
HYDRAULIC FLUID RESERVOIR.....	20-01		
HYDRAULIC/HYDROSTATIC FILTER.....	20-01		

CONTENTS

FOREWORD.....	II
SAFETY INSTRUCTIONS	V
SERIAL NUMBER LOCATION	IX
DELIVERY REPORT.....	IX
BOBCAT LOADER IDENTIFICATION.....	X
SAFETY AND MAINTENANCE.....	10-01
HYDRAULIC SYSTEM	20-01
HYDROSTATIC SYSTEM.....	30-01
DRIVE SYSTEM	40-01
MAIN FRAME	50-01
ELECTRICAL SYSTEM & ANALYSIS.....	60-01
ENGINE SERVICE	70-01
HEATER	80-01
SPECIFICATIONS.....	SPEC-01

**SAFETY &
MAINTENANCE**

**HYDRAULIC
SYSTEM**

**HYDROSTATIC
SYSTEM**

**DRIVE
SYSTEM**

MAIN FRAME

**ELECTRICAL
SYSTEM &
ANALYSIS**

**ENGINE
SERVICE**

HVAC

SPECIFICATIONS

<https://www.ebooklibonline.com>

Hello dear friend!

Thank you very much for reading.

Enter the link into your browser.

The full manual is available for immediate download.

<https://www.ebooklibonline.com>

FOREWORD

This manual is for the Bobcat loader mechanic. It provides necessary servicing and adjustment procedures for the Bobcat loader and its component parts and systems. Refer to the Operation & Maintenance Manual for operating instructions, Starting procedure, daily checks, etc.

A general inspection of the following items must be made after the loader has had service or repair:

1. Check lift arm support device, replace if damaged. (Stored Position)

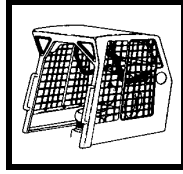

2. Check that ROPS mounting hardware is tightened and is Bobcat approved.

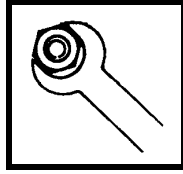

3. The seat belt must be correctly installed, functional and in good condition.

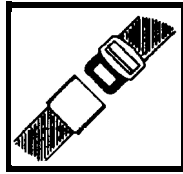

4. The seat bar must be correctly adjusted, clean and lubricated.

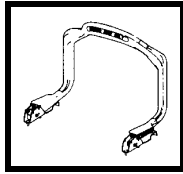

5. Check lift arm support device, replace if damaged.

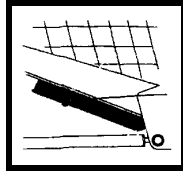

6. Machine signs must be legible and in the correct location.



7. Steering levers and foot pedals must return to neutral.

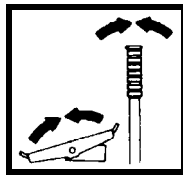

8. Check for correct function of the work lights



9. The parking brake must function correctly.



10. Enclosure door latches must open and close freely.

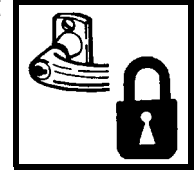

11. Bob-Tach wedges and linkages must function correctly and be in good condition.

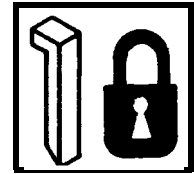

12. Safety treads must be in good condition.

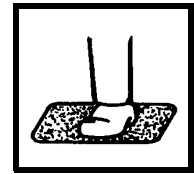

13. Check for correct function of indicator lamps (Optional on some models).

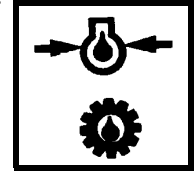

14. Check hydraulic fluid level, engine oil level and fuel supply.

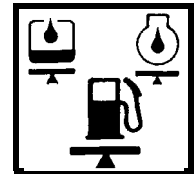

15. Inspect for fuel, oil or hydraulic fluid leaks.

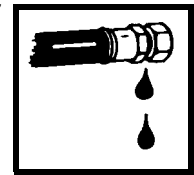

16. Lubricate the loader.

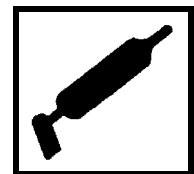

17. Check the condition of the battery and cables.

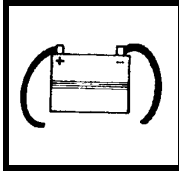

22. Operate the loader and check all functions.

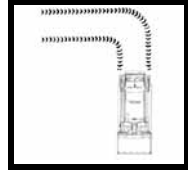

18. Inspect the air cleaner for damage or leaks. Check the condition of the element.

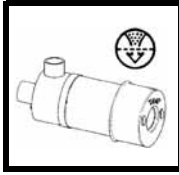

23. Check for any field modification not completed.



19. Check the electrical charging system.

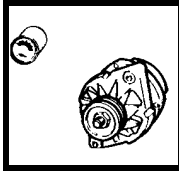

24. Check for correct function of the Bobcat Interlock Control System (BICST™) before the machine is returned to the customer.

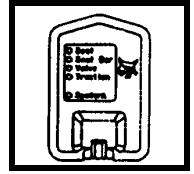

20. Check tires for wear and pressure.

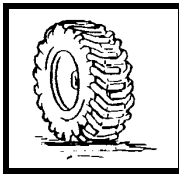

Recommend to the owner that all necessary corrections be made before the machine is returned to service.

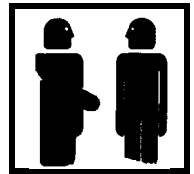

21. Inspect for loose or broken parts or connections.

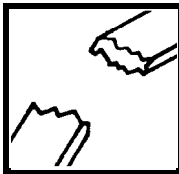

**CALIFORNIA
PROPOSITION 65 WARNING**
Diesel engine exhaust and some of its constituents are known to the State of California to cause cancer, birth defects and other reproductive harm.

SAFETY INSTRUCTIONS



Safety Alert Symbol

This symbol with a warning statement means:
“Warning, be alert! Your safety is involved!”
Carefully read the message that follows.



WARNING

Instructions are necessary before operating or servicing machine. Read and understand the Operation & Maintenance Manual, Operator's Handbook and signs (decals) on machine. Follow warnings and instructions in the manuals when making repairs, adjustments or servicing. Check for correct function after adjustments, repairs or service. Untrained operators and failure to follow instructions can cause injury or death.

W-2003-0903



WARNING

Warnings on the machine and in the manuals are for your safety. Failure to obey warnings can cause injury or death.

W-2044-1285

IMPORTANT

This notice identifies procedures which must be followed to avoid damage to the machine.

I-2019-0284

The following publications provide information on the safe use and maintenance of the Bobcat machine and attachments:

- The Delivery Report is used to assure that complete instructions have been given to the new owner and that the machine is in safe operating condition.
- The Operation & Maintenance Manual delivered with the machine or attachment contains operating information as well as routine maintenance and service procedures. It is a part of the machine and can be stored in a container provided on the machine. Replacement Operation & Maintenance Manuals can be ordered from your Bobcat dealer.
- Machine signs (decals) instruct on the safe operation and care of your Bobcat machine or attachment. The signs and their locations are shown in the Operation & Maintenance Manual. Replacement signs are available from your Bobcat dealer.
- An Operator's Handbook fastened to the operator cab. It's brief instructions are convenient to the operator. The handbook is available from your dealer in an English edition or one of many other languages. See your Bobcat dealer for more information on translated versions.
- The AEM Safety Manual delivered with the machine gives general safety information.
- The Service Manual and Parts Manual are available from your dealer for use by mechanics to do shop-type service and repair work.
- The Skid-Steer Loader Operator Training Course is available through your local dealer or at www.training.bobcat.com or www.bobcat.com. This course is intended to provide rules and practices of correct operation of the Skid-Steer Loader. The course is available in English and Spanish versions.
- Service Safety Training Courses are available from your Bobcat dealer or at www.training.bobcat.com or www.bobcat.com. They provide information for safe and correct service procedures.
- The Skid-Steer Loader Safety Video is available from your Bobcat dealer or at www.training.bobcat.com or www.bobcat.com.

SI SSL-0206 SM

SAFETY INSTRUCTIONS (CONT'D)

Fire Prevention

The machine and attachments have components that are at high temperature under normal operating conditions. The primary source of high temperatures is the engine and exhaust system. The electrical system, if damaged or incorrectly maintained, can be a source of arcs or sparks.

Flammable debris (leaves, straw, etc.) must be removed regularly. If flammable debris is allowed to accumulate, it will increase fire hazard. Clean often to avoid this accumulation. Flammable debris in the engine compartment is a potential hazard.

The spark arrestor muffler is designed to control the emission of hot particles from the engine and exhaust system, but the muffler and the exhaust gases are still hot.

- Do not use the machine where exhaust, arcs, sparks or hot components can contact flammable material, explosive dust or gases.
- The operator cab, engine compartment, and engine cooling system must be inspected every day and cleaned if necessary to prevent fire hazard and overheating.
- Check all electrical wiring and connections for damage. Keep the battery terminals clean and tight. Repair or replace any damaged part.
- Check fuel and hydraulic tubes, hoses and fittings for damage and leakage. Never use open flame or bare skin to check for leaks. Tighten or replace any parts that show leakage. Always clean fluid spills. Do not use gasoline or diesel fuel for cleaning parts. Use commercial nonflammable solvents.
- Do not use ether or starting fluids on any engine which has glow plugs. These starting aids can cause explosion and injure you or bystanders.
- Always clean the machine, disconnect the battery, and disconnect the wiring from the controllers before welding. Cover rubber hoses, battery and all other flammable parts. Keep a fire extinguisher near the machine when welding. Have good ventilation when grinding or welding painted parts. Wear a dust mask when grinding painted parts. Toxic dust or gas can be produced.
- Stop the engine and let it cool before adding fuel. **NO SMOKING!**

- Use the procedure in the Operation & Maintenance Manual for connecting the battery and for jump starting.
- Use the procedure in the Operation & Maintenance Manual for cleaning the spark arrestor muffler (if equipped).

Figure 1

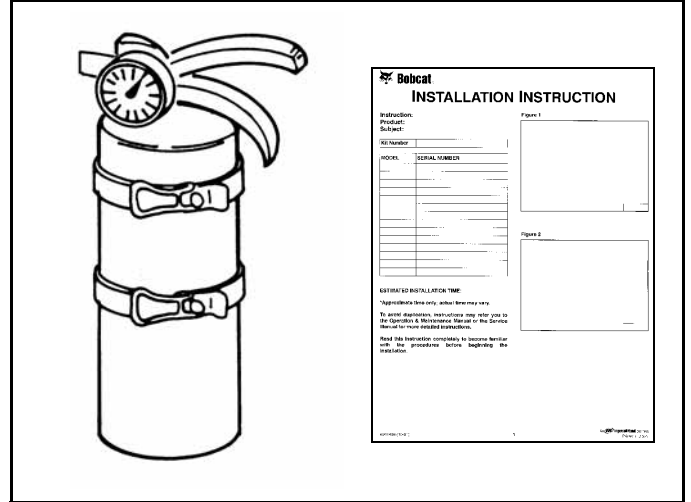

- Know where fire extinguishers and first aid kits are located and how to use them. Fire extinguishers are available from your Bobcat dealer [Figure 1].

SERIAL NUMBER LOCATION

Always use the serial number of the loader when requesting service information or when ordering parts. Early or later models (identification made by serial number) may use different parts, or it may be necessary to use a different procedure in doing a specific service operation.

Loader Serial Number

Figure 2



The loader serial number plate is located on the outside of the loader frame [Figure 2].

Explanation of loader Serial Number:

XXXX	XXXXX
Model 1.-Model/ Engine Combination	Model 2.-Production Sequence (Series)

1. The four digit Model/Engine Combination Module number identifies the model number and engine combination.
2. The five digit Production Sequence Number identifies the order which the loader is produced.

Engine Serial Number

Figure 3

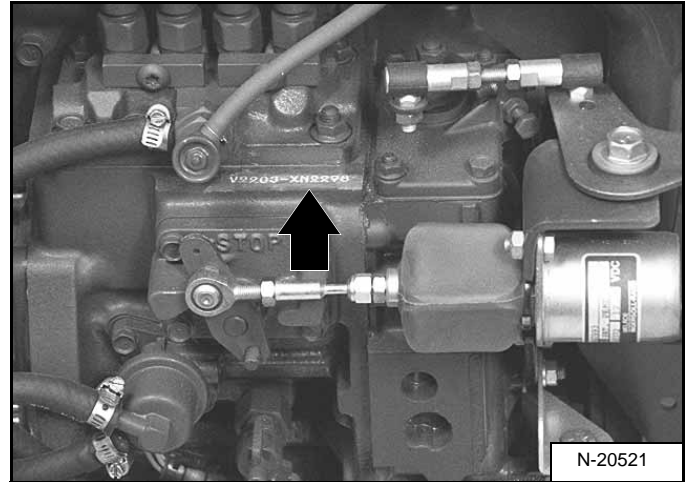

The engine serial number is located on the valve cover at the right side of the engine [Figure 3]. There is also an extra S/N tag attached to the engine [Figure 4]

DELIVERY REPORT

Figure 4

The Delivery Report must be filled out by the dealer and signed by the owner or operator when the Bobcat loader is delivered. An explanation of the form must be given to the owner. Make sure it is filled out completely [Figure 4].

BOBCAT LOADER IDENTIFICATION

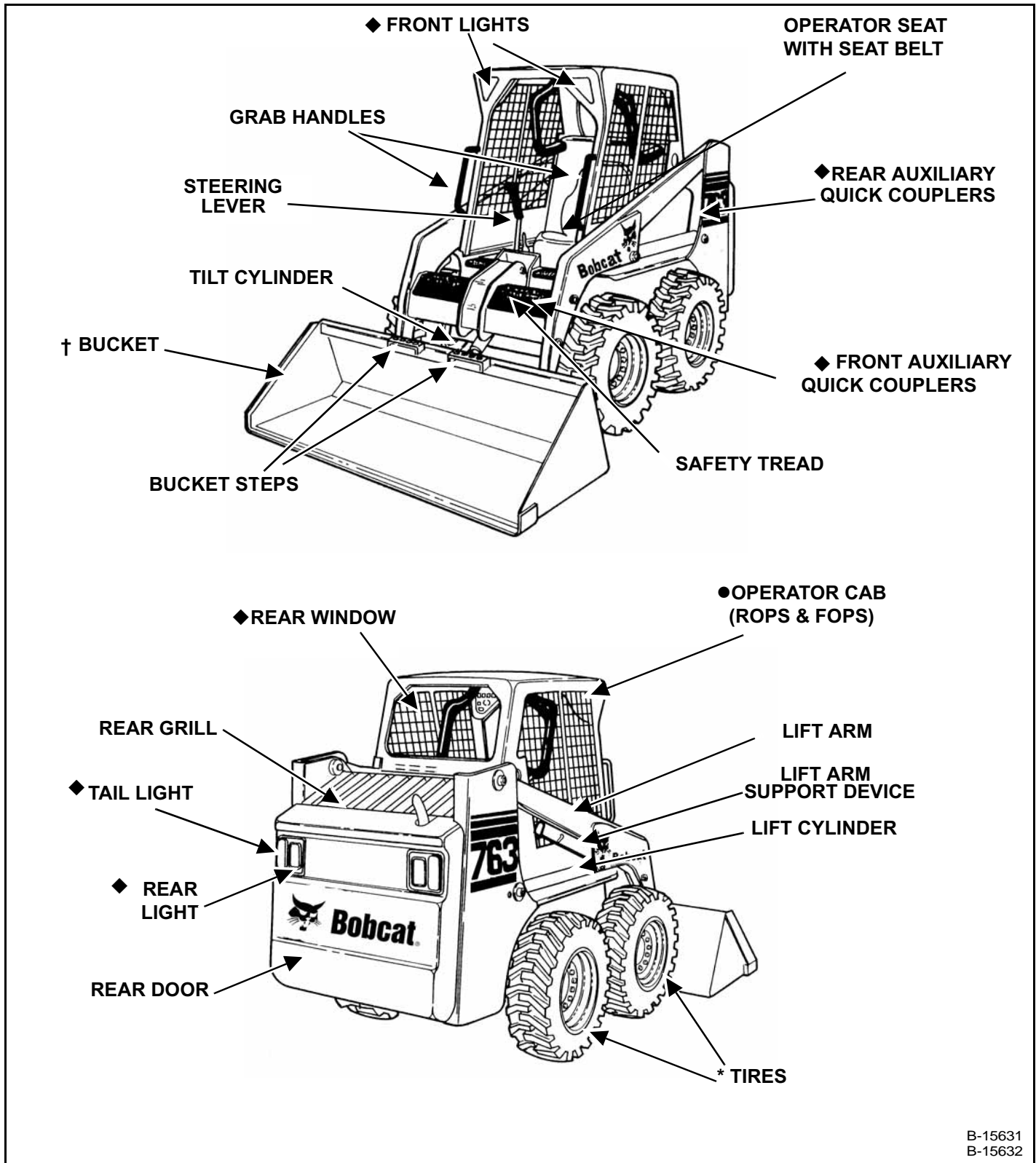

◆ OPTIONAL OR FIELD ACCESSORY (Not Standard Equipment)

- * TIRES - Flotation tires ▼ are shown. The Bobcat loader is factory equipped with standard tires.
- + BUCKET - Several different buckets and other attachments are available for the Bobcat loader.
- ROPS, FOPS - Roll Over Protective Structure, per SAE J1040 and ISO 3471, and Falling Object Protective Structure per SAEJ1043 and ISO 3449, Level I. Level II is available. The Bobcat loader is base-equipped with a standard operator cab as shown. Extra insulated cab is available as an option (Reduced noise level).

SAFETY AND MAINTENANCE

SAFETY & MAINTENANCE

AIR CLEANER SERVICE	10-80-1
Checking	10-80-1
Replacing Filter Element(s)	10-80-1
BOB-TACH	10-150-1
Inspection And Maintenance	10-150-1
ENGINE COOLING SYSTEM	10-90-1
Checking The Coolant Level	10-90-2
Cleaning The Cooling System	10-90-1
Replacing The Coolant	10-90-2
ENGINE LUBRICATION SYSTEM	10-110-1
Checking Engine Oil	10-110-1
Oil Chart	10-110-1
Replacing Oil And Filter	10-110-1
FAN GEARBOX	10-140-1
Checking And Maintaining	10-140-1
FINAL DRIVE TRANSMISSION (CHAINCASE)	10-130-1
Checking And Adding Oil	10-130-1
Removing The Oil	10-130-1
FUEL SYSTEM	10-100-1
Filling the Fuel Tank	10-100-1
Fuel Filter	10-100-2
Fuel Specifications	10-100-1
Removing Air From The Fuel System	10-100-2
HYDRAULIC/HYDROSTATIC SYSTEM	10-120-1
Breather Cap	10-120-4
Checking And Adding Fluid	10-120-1
Replacing Hydraulic Fluid	10-120-3
Replacing Hydraulic/Hydrostatic Filter	10-120-2
Replacing Hydrostatic Motor Case Drain Filter(s)	10-120-2
LIFT ARM SUPPORT DEVICE	10-20-1
Installing Lift Arm Support Device	10-20-1
Removing The Lift Arm Support Device	10-20-2
LIFTING AND BLOCKING THE LOADER	10-10-1
Procedure	10-10-1

Continued On Next Page

SAFETY AND MAINTENANCE (CONT'D)

LUBRICATION OF THE BOBCAT LOADER.....	10-160-1
Pivot Pins.....	10-160-2
Procedure.....	10-160-1
OPERATOR CAB.....	10-30-1
Description.....	10-30-1
Emergency Exit.....	10-30-3
Lowering The Operator Cab.....	10-30-2
Raising The Operator Cab.....	10-30-1
REMOTE START.....	10-60-1
Procedure.....	10-60-1
SERVICE SCHEDULE.....	10-70-1
Chart.....	10-70-1
SPARK ARRESTOR MUFFLER.....	10-180-1
Servicing.....	10-180-1
TIRE MAINTENANCE.....	10-170-1
Mounting.....	10-170-1
Rotating.....	10-170-1
Wheel Nuts.....	10-170-1
TOWING THE LOADER.....	10-50-1
Procedure.....	10-50-1
TRANSPORTING THE BOBCAT LOADER.....	10-40-1
Procedure.....	10-40-1

TIGHTEN ALL HARDWARE PER SIZE TO GRADE 5 TORQUE (See TORQUE SPECIFICATIONS FOR BOLTS on Page SPEC-30-1.) UNLESS OTHERWISE SPECIFIED.

LIFTING AND BLOCKING THE LOADER

Procedure

Figure 10-10-1

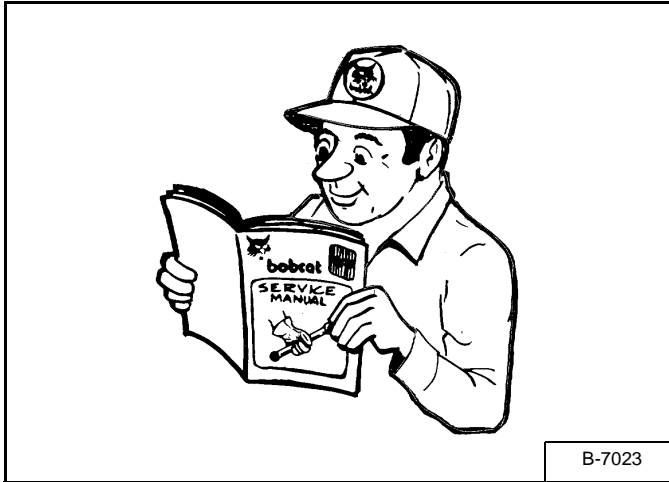

WARNING

Instructions are necessary before operating or servicing machine. Read and understand the Operation & Maintenance Manual, Handbook and signs (decals) on machine. Follow warnings and instructions in the manuals when making repairs, adjustments or servicing. Check for correct function after adjustments, repairs or service. Untrained operators and failure to follow instructions can cause injury or death.

W-2003-0199

Always park the loader on a level surface.

WARNING

Put jackstands under the front axles and rear corners of the frame before running the engine for service. Failure to use jackstands can allow the machine to fall or move and cause injury or death.

W-2017-0286

Figure 10-10-2



Put floor jack under the rear of the loader [Figure 10-10-2].

Lift the rear of the loader and install jackstands [Figure 10-10-2].

Figure 10-10-3



Put the floor jack under the front of the loader [Figure 10-10-3].

Lift the front of the loader and put jackstands under the axle tubes [Figure 10-10-3].

NOTE: Make sure the jackstands do not touch the tires. Make sure tires clear floor or any obstacles.

LIFT ARM SUPPORT DEVICE

Installing Lift Arm Support Device



Never work on a machine with the lift arms up unless the lift arms are secured by an approved lift arm support device. Failure to use an approved lift arm support device can allow the lift arms or attachment to fall and cause injury or death.

W-2059-0598



Service lift arm support device if damaged or if parts are missing. Using a damaged lift arm support or with missing parts can cause lift arms to drop causing injury or death.

W-2271-1197

Figure 10-20-1

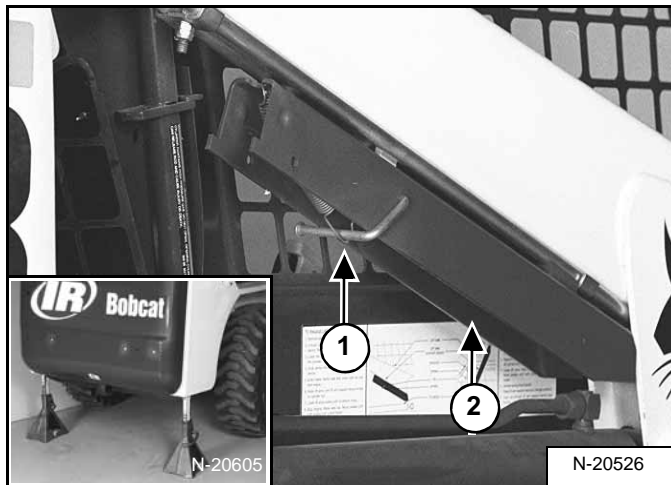

Put jackstands under the rear corners of the loader frame (Inset) [Figure 10-20-1].

Disconnect the spring from the lift arm support device retaining pin (Item 1) [Figure 10-20-1]. Support the lift arm support device (Item 2) [Figure 10-20-1] with your hand and remove the retaining pin.

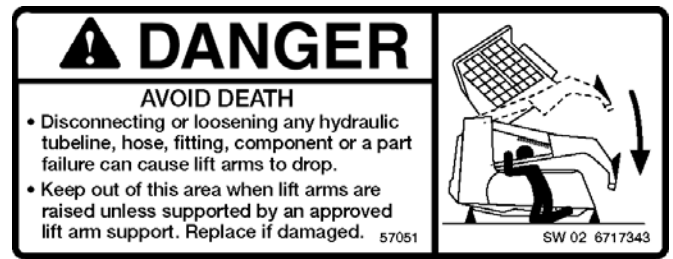
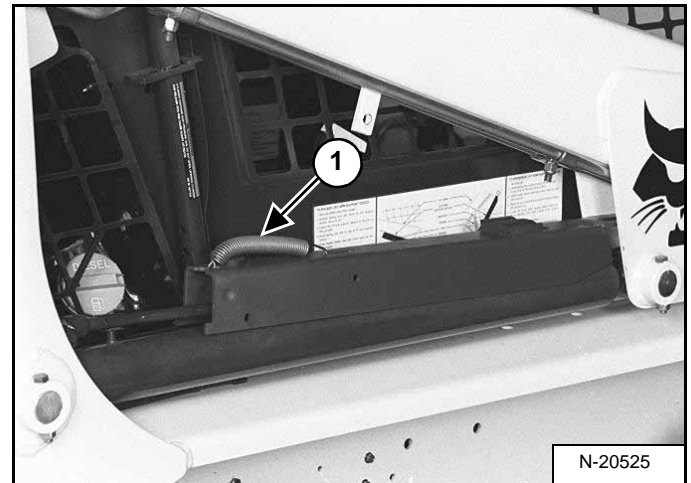

Figure 10-20-2



Lower the lift arm support device on top of the lift cylinder. Hook the free end of the spring (Item 1) [Figure 10-20-2] to the lift arm support device so there will be no interference with the support device engagement.

With the operator in the seat, seat belt fastened and seat bar lowered, start the engine.

LIFT ARM SUPPORT DEVICE (CONT'D)

Installing Lift Arm Support Device (Cont'd)

Figure 10-20-3

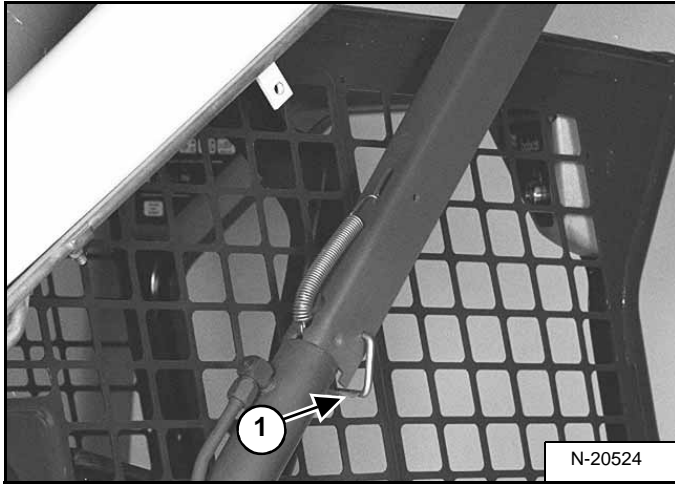

Raise the lift arms, until the lift arm support device drops onto the lift cylinder rod **[Figure 10-20-3]**.

Lower the lift arms slowly until the support device is held between the lift arm and the lift cylinder. Stop the engine. Raise the seat bar and move pedals until both pedals lock.

Install pin (Item 1) **[Figure 10-20-3]** into the rear of the lift arm support device below the cylinder rod.

Removing The Lift Arm Support Device

Figure 10-20-4

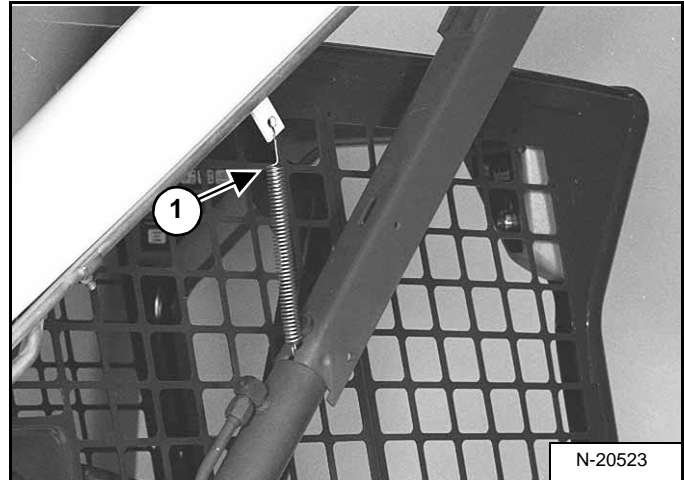

Remove the pin from the lift arm support device.

Connect the spring (Item 1) **[Figure 10-20-4]** from the lift arm support device to the bracket below the lift arms.

With the operator in the seat, seat belt fastened and seat bar lowered, start the engine.

Raise the lift arms a small amount and the spring will lift the support device off the lift cylinder rod. Lower the lift arms. Stop the engine.

Raise the seat bar and move pedals until both pedals lock.

Disconnect the spring from the bracket.

LIFT ARM SUPPORT DEVICE (CONT'D)

Removing The Lift Arm Support Device (Cont'd)

Figure 10-20-5

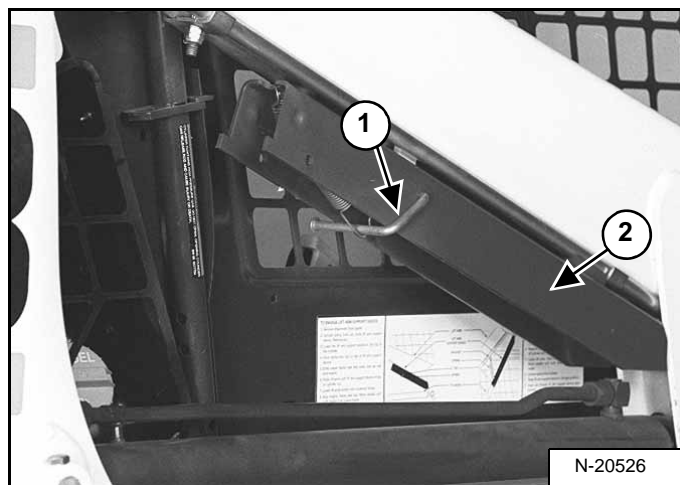

Raise the support device into storage position and insert pin (Item 1) [Figure 10-20-5] through lift arm support device (Item 2) [Figure 10-20-5] and bracket. Connect spring to pin.

Remove jackstands.

OPERATOR CAB

Description

The Bobcat loader has an operator cab (ROPS and FOPS) as standard equipment to protect the operator from rollover and falling objects. Check with your dealer if the operator cab has been damaged. The seat belt must be worn for roll over protection.

ROPS/FOPS - Roll Over Protective Structure per SAE J1040 and ISO 3471, and Falling Object Protective Structure per SAE J1043 and ISO 3449, Level I. Level II is available.

Level I - Protection from falling bricks, small concrete blocks, and hand tools encountered in operations such as highway maintenance, landscaping, and other construction site services.

Level II - Protection from falling trees, rocks; for machines involved in site clearing, overhead demolition or forestry.

Raising The Operator Cab

Always stop the engine before raising or lowering the cab.

NOTE: Make sure the seat bar is fully raised or lowered when lowering the cab. Always use the grab handles to lower the cab.

Stop the loader on a level surface. Lower the lift arms. If the lift arms must be up while raising the operator cab, install the lift arm support device. (See Installing Lift Arm Support Device on Page 10-20-1.)

Figure 10-30-1

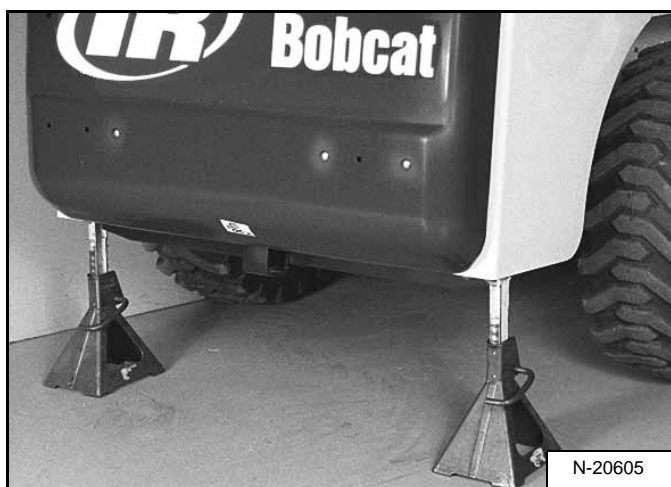

Install jackstands under the rear of the loader frame [Figure 10-30-1].

Advanced Hand Control and Control System



Never modify operator cab by welding, grinding, drilling holes or adding attachments unless instructed to do so by Bobcat. Changes to the cab can cause loss of operator protection from rollover and falling objects, and result in injury or death.

W-2069-1299

Figure 10-30-2

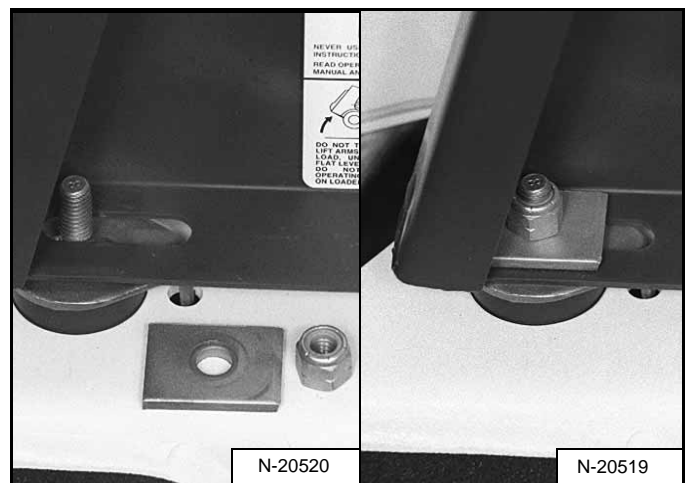

Loosen the nut (both sides) at the front corners of the operator cab [Figure 10-30-2]

Remove the nuts and plates [Figure 10-30-2] (both sides).

OPERATOR CAB (CONT'D)

Raising The Operator Cab (Cont'd)

Figure 10-30-3



Lift on the grab handle and bottom of the operator cab slowly until the cab is all the way up and the latching mechanism engages [Figure 10-30-3].

Figure 10-30-4



Advanced Hand Controls Only

Lowering The Operator Cab

Always stop the engine before raising or lowering the cab.

NOTE: Make sure the seat bar is fully raised or lowered when lowering the cab. Always use the grab handles to lower the cab.

Pull down on the bottom of the operator cab until it stops at the latching mechanism [Figure 10-30-4].

Release the latching mechanism (Inset) [Figure 10-30-4] and pull the cab all the way down.

OPERATOR CAB (CONT'D)

Lowering The Operator Cab (Cont'd)

Figure 10-30-5

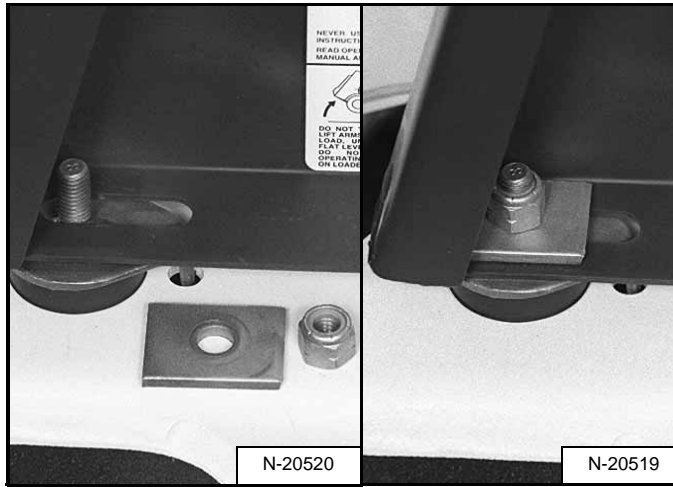

Install the plates and nuts [Figure 10-30-5] (both sides).

Tighten the nuts to 40-50 ft.-lbs. (54-68 Nm) torque.

Emergency Exit

Figure 10-30-6



The front opening on the operator cab and rear window provide exits.

Rear Window (If Equipped)

Pull on the tag on the top of the rear window to remove the rubber cord [Figure 10-30-6].

Figure 10-30-7



Push the rear window out of the rear of the operator cab.

Exit through the rear of the operator cab [Figure 10-30-7].

Figure 10-30-8

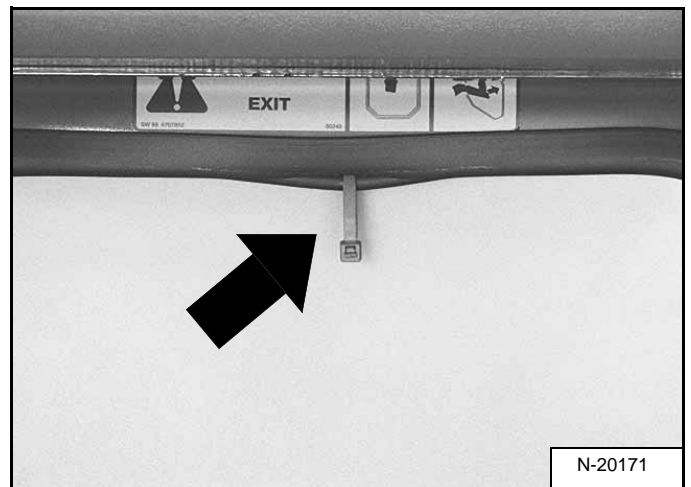

Front Door (If Equipped)

NOTE: When an Operator Cab Enclosure Kit is installed, the window of the front door can be used as an emergency exit [Figure 10-30-8].

Pull the plastic loop at the top of the window in the front door to remove the rubber cord [Figure 10-30-8].

OPERATOR CAB (CONT'D)

Emergency Exit (Cont'd)

Figure 10-30-9

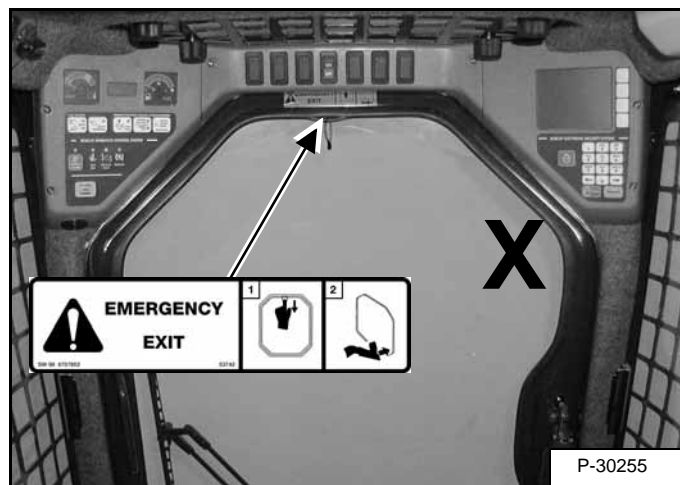

Figure 10-30-10

Push the window out with your foot [Figure 10-30-9] at any corner of the window.

Exit through the front door.

TRANSPORTING THE BOBCAT LOADER

Procedure

Figure 10-40-1

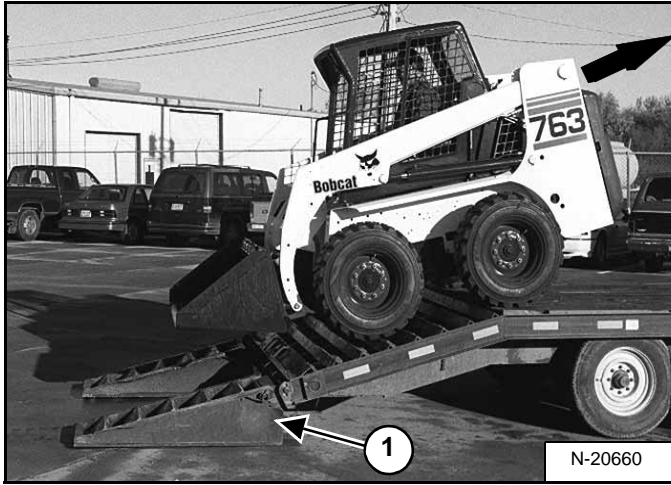

Adequately designed ramps of sufficient strength are needed to support the weight of the machine when loading onto a transport vehicle. Wood ramps can break and cause personal injury.

W-2058-0494

A loader with an empty bucket or no attachment must be loaded backward onto the transport vehicle [Figure 10-40-1].

Be sure the transport and towing vehicles are of adequate size and capacity. (See Performance on Page SPEC-10-2.)

The rear of the trailer must be blocked or supported (Item 1) [Figure 10-40-1] when loading or unloading the loader to prevent the front end of the trailer from raising up.

Figure 10-40-2

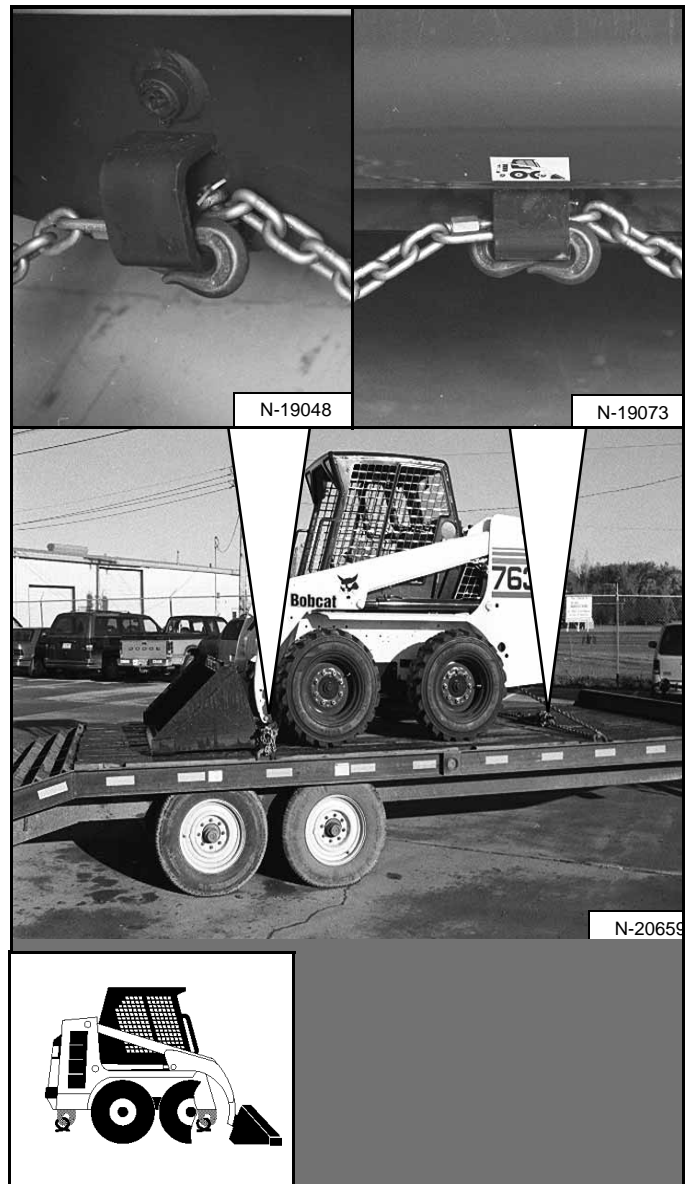

Use the following procedure to fasten the Bobcat loader to the transport vehicle to prevent the loader from moving during sudden stops or when going up or down slopes [Figure 10-40-2].

- Lower the bucket or attachment to the floor.
- Stop the engine.
- Engage the parking brake.
- Install chains at the front and rear loader tie down positions (Inset) [Figure 10-40-2].
- Fasten each end of the chain to the transport vehicle.

TOWING THE LOADER

Procedure

Figure 10-50-1



To prevent damage to the loader's hydrostatic system, the loader must be towed only a short distance at slow speed. (Example: Moving the loader onto a transport vehicle).

The towing chain (or cable) must be rated at 1 & 1/2 times the weight of the loader. (See Performance on Page SPEC-10-2.)

- Turn the key switch to RUN (Item 1) [Figure 10-50-1] (Standard Panel) OR press the RUN/ENTER Button (Deluxe Panel).

Figure 10-50-2

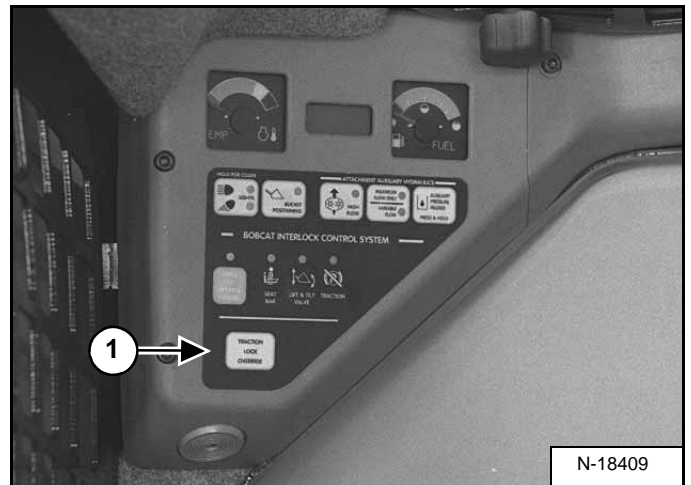

- Press the TRACTION LOCK OVERRIDE Button (Item 1)[Figure 10-50-2].
- Tow the Bobcat at 2 MPH (3,2 km/hr) or less for not more than 25 feet (7,6 meters).

If the electrical system is not functioning or the engine does not run part of the brake system must be disassembled to move the loader. (See TRACTION LOCK on Page 60-110-1.)

REMOTE START

Procedure



AVOID INJURY OR DEATH

With the 7-pin connector plugged into the loader and Remote Start Key Switch in the OFF position, the loader can still be started from the operator panel inside the cab. Placing the key switch of the remote start tool in the run position disconnects the operator panel key switch from the start circuit. If the service technician will be working the engine area it is important to remove the operator panel keys.

W-2357-0899

Figure 10-60-1



The tool listed will be need to do the following procedure:

MEL1563: Remote Start Tool Kit

The remote start tool (Item 1) [Figure 10-60-1] is required when the operator cab is in the raised position for service and the service technician needs to turn the key switch on or start the engine. Example: adjusting the steering linkage.

Figure 10-60-2

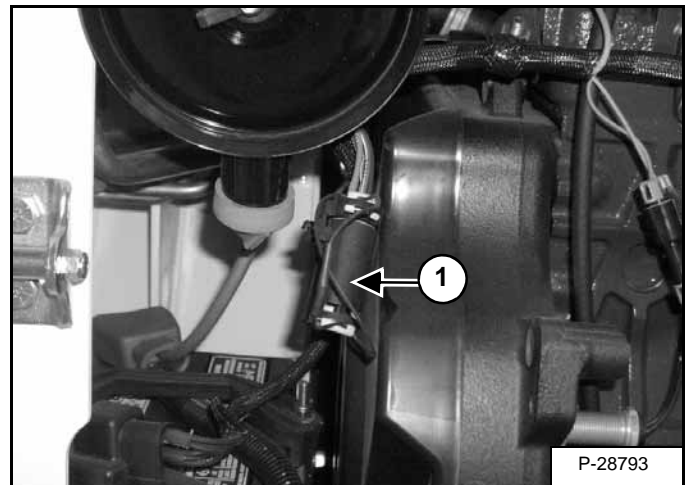
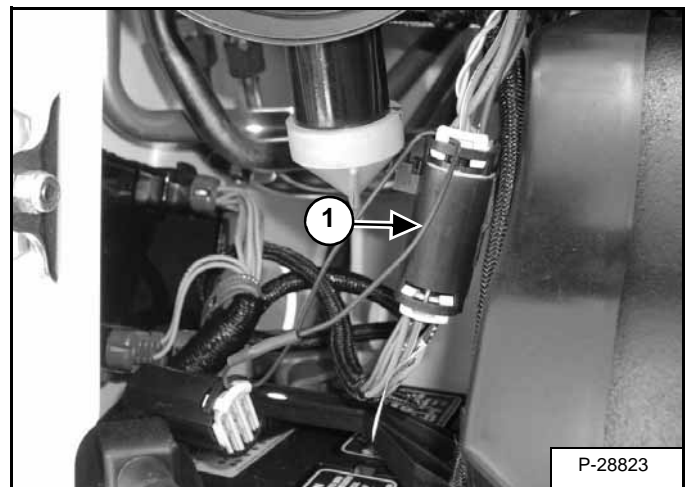

Figure 10-60-3



Lift and block the loader. (See **LIFTING AND BLOCKING THE LOADER** on Page 10-10-1.)

Raise the lift arms (if required by the procedure) and install an approved lift arm support device. (See **Installing Lift Arm Support Device** on Page 10-20-1.)

Raise the operator cab (if required by the procedure). (See **Raising The Operator Cab** on Page 10-30-1.)

Open the rear door of the loader.

Remove the plug (Item 1) [Figure 10-60-2] or disconnect the attachment control harness (Item 1) [Figure 10-60-3] if connected.



Suggest:

If the above button click is invalid.

Please download this document

first, and then click the above link

to download the complete manual.

Thank you so much for reading

REMOTE START (CONT'D)

Procedure (Cont'd)

Figure 10-60-4

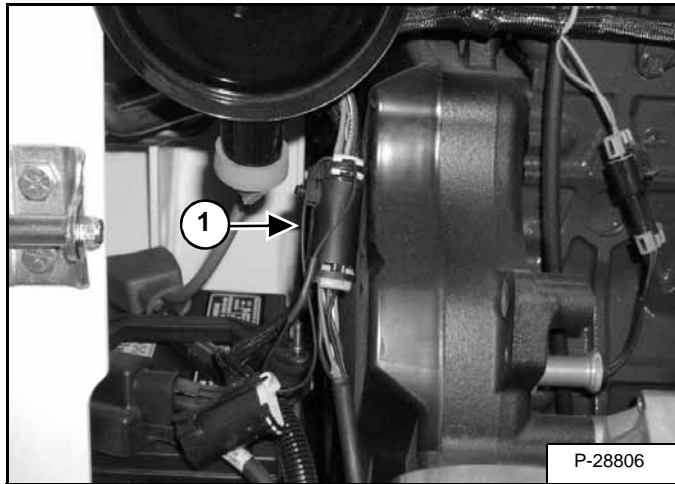

Connect the remote start tool to the engine harness connector (Item 1) [Figure 10-60-4].

NOTE: The key switch on the right-hand side operator panel must be in the off position or the Remote Start Kit will not operate.

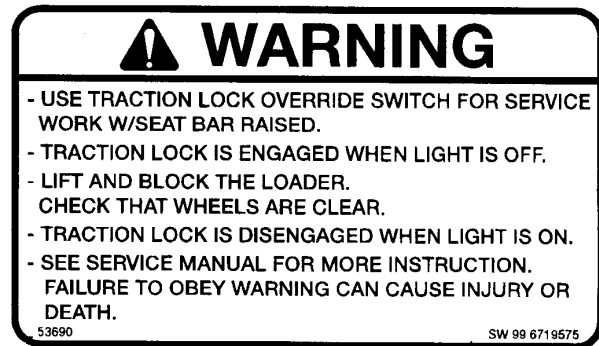
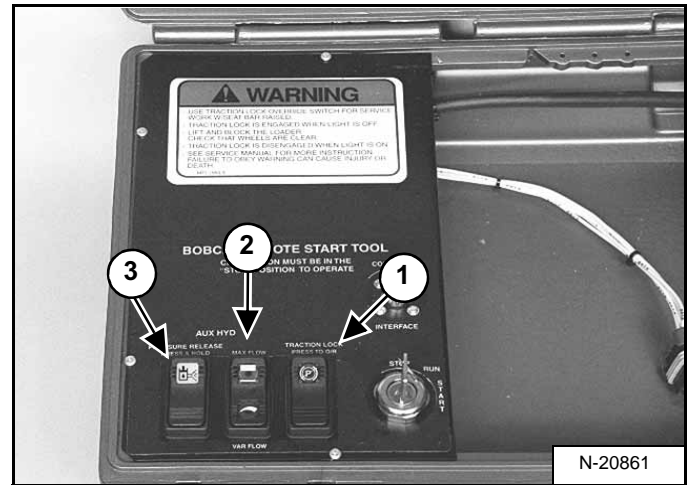

Figure 10-60-5



The remote start tool (Item 1) [Figure 10-60-5] has three rocker switches.

Figure 10-60-6



The traction lock switch (Item 1) [Figure 10-60-6] is used to turn traction lock on or off. Push the switch to the override position. The switch will illuminate to indicate traction lock OVERRIDE, in this position the wheels are able to turn.

The maximum flow/variable flow switch (Item 2) [Figure 10-60-6] is used to activate the auxiliary hydraulics. Pressing the switch once will activate variable flow. Pressing the switch again will activate maximum flow. The switch will illuminate to indicate which flow rate is active. Pressing the switch a third time will turn the flow OFF. The switch is used when checking pressures and flow rate.

S/N 512263234 & Below

The auxiliary pressure release (Item 3) [Figure 10-60-6] is used to release hydraulic pressure to the front and/or rear auxiliary couplers. To release pressure; push and hold the switch for three seconds.

NOTE: With the engine running; pushing and holding the pressure release switch this will cause the engine to stop in three seconds. To relieve the pressure; continue to press the switch after the engine has stopped.

<https://www.ebooklibonline.com>

Hello dear friend!

Thank you very much for reading.

Enter the link into your browser.

The full manual is available for immediate download.

<https://www.ebooklibonline.com>