

463



Bobcat®

Service Manual

S/N 538911001 & Above
S/N 539011001 & Above

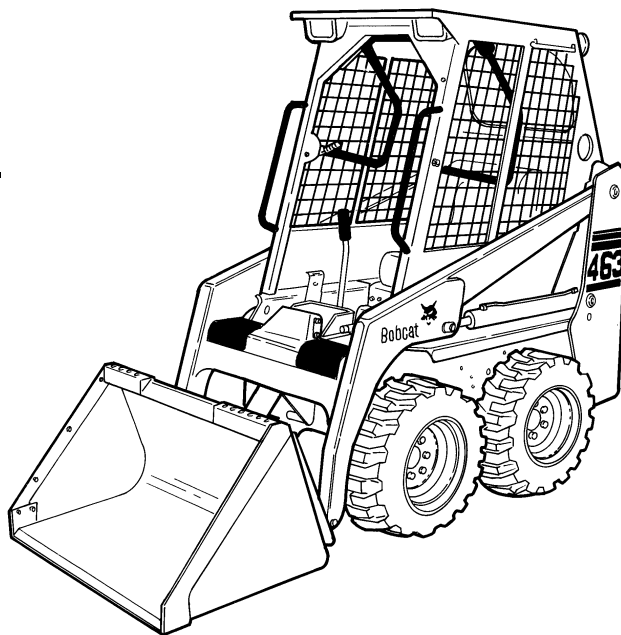

**EQUIPPED WITH
BOBCAT INTERLOCK
CONTROL SYSTEM (BICS™)**



Printed in U.S.A.

© Bobcat Company 2007

MAINTENANCE SAFETY



WARNING

Instructions are necessary before operating or servicing machine. Read and understand the Operation & Maintenance Manual, Operator's Handbook and signs (decals) on machine. Follow warnings and instructions in the manuals when making repairs, adjustments or servicing. Check for correct function after adjustments, repairs or service. Untrained operators and failure to follow instructions can cause injury or death.

W-2003-0903



Safety Alert Symbol: This symbol with a warning statement, means: "Warning, be alert! Your safety is involved!" Carefully read the message that follows.

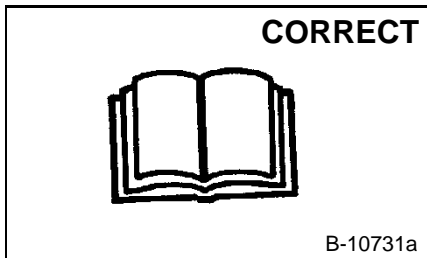

B-10731a

⚠ Never service the Bobcat Skid-Steer Loader without instructions.

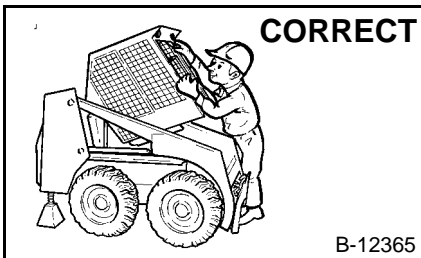

B-12365

⚠ Use the correct procedure to lift or lower operator cab.

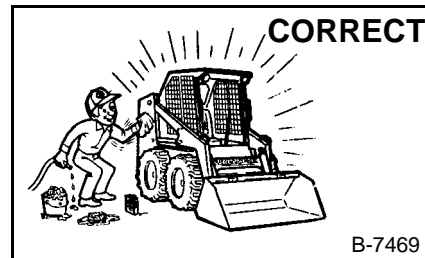

B-7469

⚠ Cleaning and maintenance are required daily.

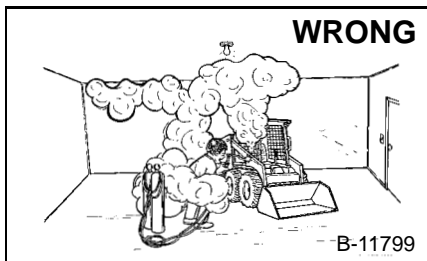

B-11799

- ⚠ Have good ventilation when welding or grinding painted parts.
- ⚠ Wear dust mask when grinding painted parts. Toxic dust and gas can be produced.
- ⚠ Avoid exhaust fume leaks which can kill without warning. Exhaust system must be tightly sealed.

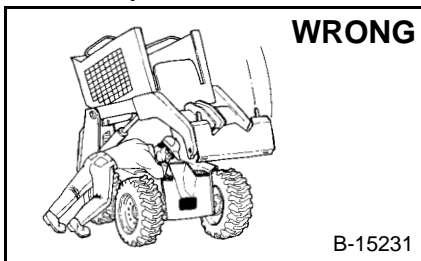

B-15231

⚠ Disconnecting or loosening any hydraulic tubeline, hose, fitting, component or a part failure can cause lift arms to drop. Do not go under lift arms when raised unless supported by an approved lift arm support device. Replace it if damaged.

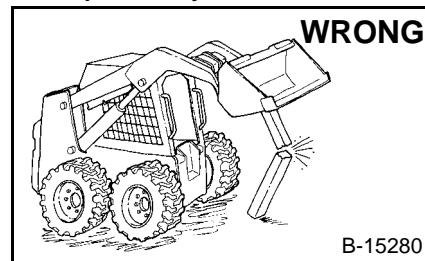

B-15280

- ⚠ Never work on loader with lift arms up unless lift arms are held by an approved lift arm support device. Replace if damaged.
- ⚠ Never modify equipment or add attachments not approved by Bobcat Company.

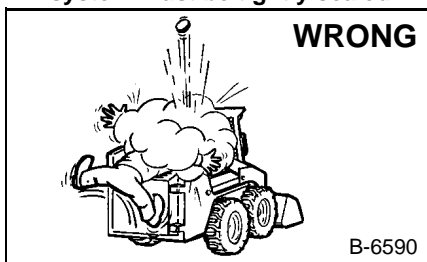

B-6590

- ⚠ Stop, cool and clean engine of flammable materials before checking fluids.
- ⚠ Never service or adjust loader with the engine running unless instructed to do so in the manual.
- ⚠ Avoid contact with leaking hydraulic fluid or diesel fuel under pressure. It can penetrate the skin or eyes.
- ⚠ Never fill fuel tank with engine running, while smoking or when near open flame.

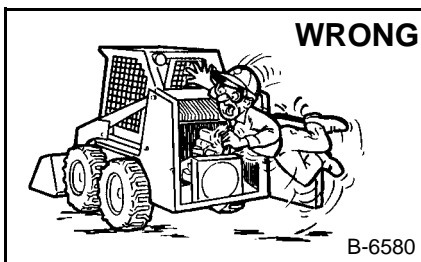

B-6580

- ⚠ Keep body, jewelry and clothing away from moving parts, electrical contact, hot parts and exhaust.
- ⚠ Wear eye protection to guard from battery acid, compressed springs, fluids under pressure and flying debris when engines are running or tools are used. Use eye protection approved for type of welding.
- ⚠ Keep rear door closed except for service. Close and latch door before operating the loader.

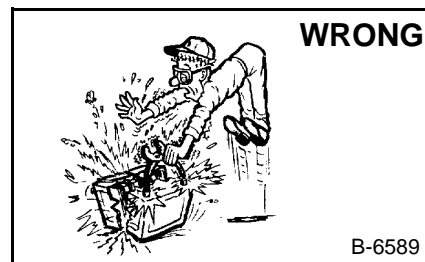

B-6589

- ⚠ Lead-acid batteries produce flammable and explosive gases.
- ⚠ Keep arcs, sparks, flames and lighted tobacco away from batteries.
- ⚠ Batteries contain acid which burns eyes or skin on contact. Wear protective clothing. If acid contacts body, flush well with water. For eye contact flush well and get immediate medical attention.

Maintenance procedures which are given in the Operation & Maintenance Manual can be performed by the owner/operator without any specific technical training. Maintenance procedures which are **not** in the Operation & Maintenance Manual must be performed **ONLY BY QUALIFIED BOBCAT SERVICE PERSONNEL**. Always use genuine Bobcat replacement parts. The Service Safety Training Course is available from your Bobcat dealer.

MSW01-0805

ALPHABETICAL INDEX

AIR CLEANER	70-01	INSTRUMENT PANEL.....	60-01
AIR CLEANER SERVICE	10-01	LIFT ARMS.....	50-01
ALTERNATOR	60-01	LIFT ARM BY-PASS VALVE	20-01
AUXILIARY CONTROL LOCKBOLT	10-01	LIFT ARM SUPPORT DEVICE	10-01
BATTERY	60-01	LIFTING AND BLOCKING THE LOADER.....	10-01
BICS™ SYSTEM (WITH PRESS TO OPERATE BUTTON)	60-01	LIGHTS	60-01
BICS™ SYSTEM CONTROLLER.....	60-01	LOADER SPECIFICATIONS	SPEC-01
BOB-TACH	10-01, 50-01	LUBRICATING THE LOADER.....	10-01
CHAINCASE	40-01	MAIN RELIEF VALVE	20-01
CHARGE PRESSURE.....	30-01	MUFFLER.....	70-01
CONTROLS	20-01	OIL COOLER	30-01
CONTROL PANEL.....	30-01	OPERATOR CAB	10-01, 50-01
CONVERSIONS	SPEC-01	OPERATOR SEAT.....	50-01
COOLING FAN	70-01	PARKING BRAKE.....	40-01
CYLINDER (LIFT)	20-01	PIVOT PINS	10-01
CYLINDER (TILT)	20-01	RADIATOR	70-01
DRIVE BELT	30-01	REAR DOOR.....	50-01
DRIVE COMPONENTS	40-01	REAR WINDOW	50-01
ELECTRICAL SYSTEM INFORMATION	60-01	RECONDITIONING THE ENGINE	70-01
ENGINE	70-01	REMOTE START SWITCH	10-01
ENGINE COMPONENTS AND TESTING	70-01	SEAT BAR RESTRAINT SYSTEM.....	10-01
ENGINE COOLING SYSTEM.....	10-01	SEAT BAR	50-01
ENGINE LUBRICATION SYSTEM.....	10-01	SEAT BAR SENSOR	60-01
ENGINE MOUNTING BRACKET.....	70-01	SERVICE SCHEDULE	10-01
ENGINE SPECIFICATIONS	SPEC-01	SPARK ARRESTOR MUFFLER.....	10-01
ENGINE SPEED CONTROL	70-01	STARTER	60-01
FINAL DRIVE TRANSMISSION (CHAINCASE)	10-01	STEERING	30-01
FLYWHEEL	70-01	TIRE MAINTENANCE	10-01
FUEL SYSTEM	10-01	TORQUE SPECIFICATIONS FOR BOLTS	SPEC-01
FUEL TANK.....	50-01	TOWING THE LOADER	10-01
HYDRAULIC CONNECTION SPECS	SPEC-01	TRACTION LOCK	60-01
HYDRAULIC CONTROL VALVE.....	20-01	TRANSPORTING THE LOADER	10-01
HYDRAULIC FILTER	20-01	TROUBLESHOOTING	70-01
HYDRAULIC FLUID SPECIFICATIONS	SPEC-01		
HYDRAULIC PUMP	20-01		
HYDRAULIC RESERVOIR	20-01		
HYDRAULIC SYSTEM INFORMATION.....	20-01		
HYDRAULIC/HYDROSTATIC SYSTEM	10-01		
HYDROSTATIC MOTOR	30-01		
HYDROSTATIC PUMP	30-01		
HYDROSTATIC SYSTEM INFORMATION	30-01		

<https://www.ebooklibonline.com>

Hello dear friend!

Thank you very much for reading.

Enter the link into your browser.

The full manual is available for immediate download.

<https://www.ebooklibonline.com>

CONTENTS

FOREWORD.....	II
SAFETY INSTRUCTIONS	V
SERIAL NUMBER LOCATIONS	IX
DELIVERY REPORT.....	IX
BOBCAT LOADER IDENTIFICATION.....	X
SAFETY AND MAINTENANCE.....	10-01
HYDRAULIC SYSTEM	20-01
HYDROSTATIC SYSTEM.....	30-01
DRIVE SYSTEM	40-01
MAIN FRAME	50-01
ELECTRICAL SYSTEM & ANALYSIS.....	60-01
ENGINE SERVICE	70-01
SPECIFICATIONS.....	SPEC-01

**SAFETY &
MAINTENANCE**

**HYDRAULIC
SYSTEM**

**HYDROSTATIC
SYSTEM**

**DRIVE
SYSTEM**

MAIN FRAME

**ELECTRICAL
SYSTEM &
ANALYSIS**

**ENGINE
SERVICE**

SPECIFICATIONS

FOREWORD

This manual is for the Bobcat loader excavator mechanic. It provides necessary servicing and adjustment procedures for the Bobcat loader and its component parts and systems. Refer to the for operating instructions, starting procedure, daily checks, etc.

A general inspection of the following items must be made after the loader has had service or repair:

1. Check that the ROPS/FOPS (Including side screens) is in good condition and is not modified.

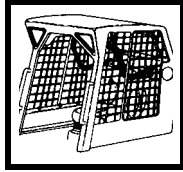

9. The parking brake must function correctly.



2. Check that ROPS mounting hardware is tightened and is Melroe approved.



10. Enclosure door latches must open and close freely.

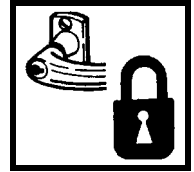

3. The seat belt must be correctly installed, functional and in good condition.

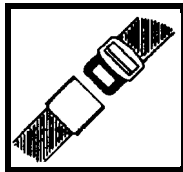

11. Bob-Tach wedges and linkages must function correctly and be in good condition.

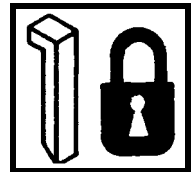

4. The seat bar and pedal interlocks must be correctly adjusted, clean and lubricated.

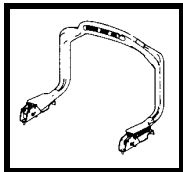

12. Safety treads must be in good condition.

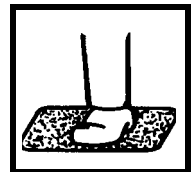

5. Check lift arm support device, replace if damaged.

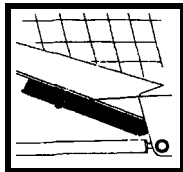

13. Check for correct function of indicator lamps (Optional on some models).

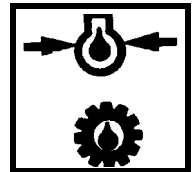

6. Machine signs must be legible and in the correct location.



14. Check hydraulic fluid level, engine oil level and fuel supply.

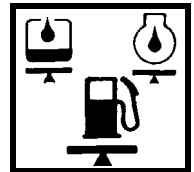

7. Steering levers and foot pedals must return to neutral.

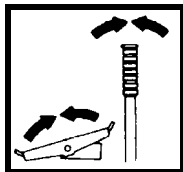

15. Inspect for fuel, oil or hydraulic fluid leaks.

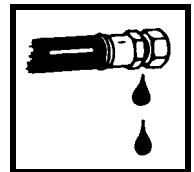

8. Check for correct function of the work lights.



16. Lubricate the loader.

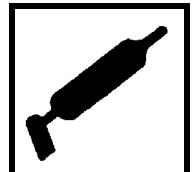

17. Check the condition of the battery and cables.

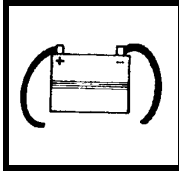

18. Inspect the air cleaner for damage or leaks. Check the condition of the element.

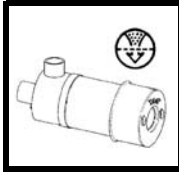

19. Check the electrical charging system.

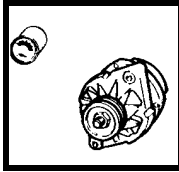

20. Check tires for wear and pressure.

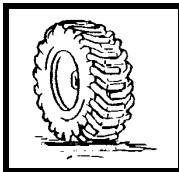

21. Inspect for loose or broken parts or connections.

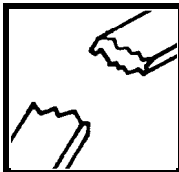

22. Operate the loader and check all functions.

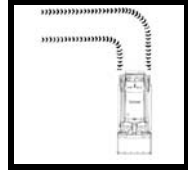

23. Check for any field modification not completed.



24. Check for correct function of the Bobcat Interlock Control System (BICST™) before the machine is returned to the customer.

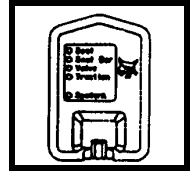

Recommend to the owner that all necessary corrections be made before the machine is returned to service.

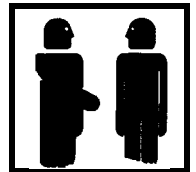

**CALIFORNIA
PROPOSITION 65 WARNING**
Diesel engine exhaust and some of its constituents are known to the State of California to cause cancer, birth defects and other reproductive harm.

SAFETY INSTRUCTIONS



Safety Alert Symbol

This symbol with a warning statement means: **“Warning, be alert! Your safety is involved!”**
Carefully read the message that follows.



WARNING

Instructions are necessary before operating or servicing machine. Read and understand the Operation & Maintenance Manual, Operator's Handbook and signs (decals) on machine. Follow warnings and instructions in the manuals when making repairs, adjustments or servicing. Check for correct function after adjustments, repairs or service. Untrained operators and failure to follow instructions can cause injury or death.

W-2003-0903



WARNING

Warnings on the machine and in the manuals are for your safety. Failure to obey warnings can cause injury or death.

W-2044-1285

IMPORTANT

This notice identifies procedures which must be followed to avoid damage to the machine.

I-2019-0284

The following publications provide information on the safe use and maintenance of the Bobcat machine and attachments:

- The Delivery Report is used to assure that complete instructions have been given to the new owner and that the machine is in safe operating condition.
- The Operation & Maintenance Manual delivered with the machine or attachment contains operating information as well as routine maintenance and service procedures. It is a part of the machine and can be stored in a container provided on the machine. Replacement Operation & Maintenance Manuals can be ordered from your Bobcat dealer.
- Machine signs (decals) instruct on the safe operation and care of your Bobcat machine or attachment. The signs and their locations are shown in the Operation & Maintenance Manual. Replacement signs are available from your Bobcat dealer.
- An Operator's Handbook fastened to the operator cab. It's brief instructions are convenient to the operator. The handbook is available from your dealer in an English edition or one of many other languages. See your Bobcat dealer for more information on translated versions.
- The AEM Safety Manual delivered with the machine gives general safety information.
- The Service Manual and Parts Manual are available from your dealer for use by mechanics to do shop-type service and repair work.
- The Skid-Steer Loader Operator Training Course is available through your local dealer or at www.training.bobcat.com or www.bobcat.com. This course is intended to provide rules and practices of correct operation of the Skid-Steer Loader. The course is available in English and Spanish versions.
- Service Safety Training Courses are available from your Bobcat dealer or at www.training.bobcat.com or www.bobcat.com. They provide information for safe and correct service procedures.
- The Skid-Steer Loader Safety Video is available from your Bobcat dealer or at www.training.bobcat.com or www.bobcat.com.

SI SSL-0206 SM

SAFETY INSTRUCTIONS (CONT'D)

Fire Prevention

The machine and attachments have components that are at high temperature under normal operating conditions. The primary source of high temperatures is the engine and exhaust system. The electrical system, if damaged or incorrectly maintained, can be a source of arcs or sparks.

Flammable debris (leaves, straw, etc.) must be removed regularly. If flammable debris is allowed to accumulate, it will increase fire hazard. Clean often to avoid this accumulation. Flammable debris in the engine compartment is a potential hazard.

The spark arrestor muffler is designed to control the emission of hot particles from the engine and exhaust system, but the muffler and the exhaust gases are still hot.

- Do not use the machine where exhaust, arcs, sparks or hot components can contact flammable material, explosive dust or gases.
- The operator cab, engine compartment, and engine cooling system must be inspected every day and cleaned if necessary to prevent fire hazard and overheating.
- Check all electrical wiring and connections for damage. Keep the battery terminals clean and tight. Repair or replace any damaged part.
- Check fuel and hydraulic tubes, hoses and fittings for damage and leakage. Never use open flame or bare skin to check for leaks. Tighten or replace any parts that show leakage. Always clean fluid spills. Do not use gasoline or diesel fuel for cleaning parts. Use commercial nonflammable solvents.
- Do not use ether or starting fluids on any engine which has glow plugs. These starting aids can cause explosion and injure you or bystanders.
- Always clean the machine, disconnect the battery, and disconnect the wiring from the controllers before welding. Cover rubber hoses, battery and all other flammable parts. Keep a fire extinguisher near the machine when welding. Have good ventilation when grinding or welding painted parts. Wear a dust mask when grinding painted parts. Toxic dust or gas can be produced.
- Stop the engine and let it cool before adding fuel. **NO SMOKING!**

- Use the procedure in the Operation & Maintenance Manual for connecting the battery and for jump starting.
- Use the procedure in the Operation & Maintenance Manual for cleaning the spark arrestor muffler (if equipped).

Figure 1

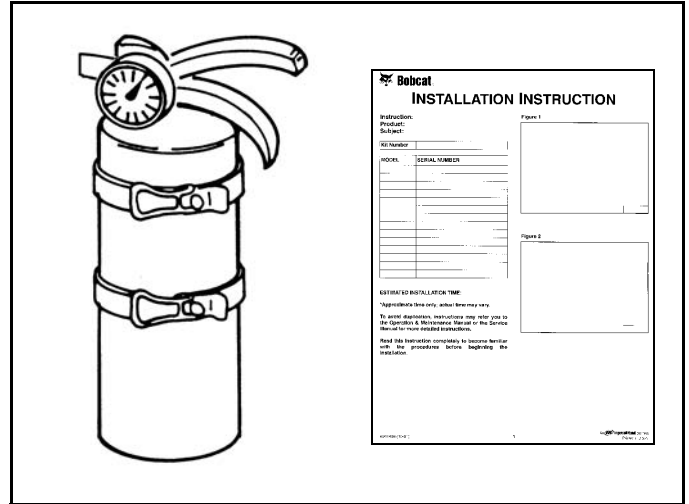

- Know where fire extinguishers and first aid kits are located and how to use them. Fire extinguishers are available from your Bobcat dealer [Figure 1].

SERIAL NUMBER LOCATIONS

Always use the serial number of the loader when requesting service information or when ordering parts. Early or later models (identification made by serial number) may use different parts, or it may be necessary to use a different procedure in doing a specific service operation.

Bobcat Loader Serial Number

Figure 2

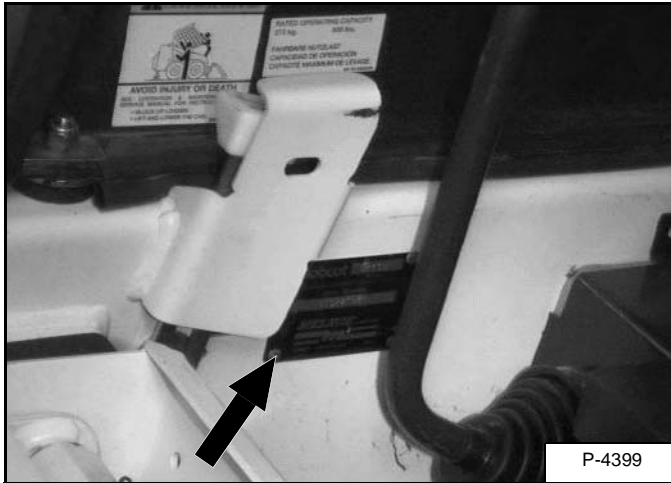

The loader serial number plate is located on the inside of the operator cab on the right fender and in front of the seat [Figure 2].

Explanation of loader Serial Number:

XXXX	XXXXX
Model/ Engine Version	Production Sequence (Series)

Engine Serial Number

Figure 3

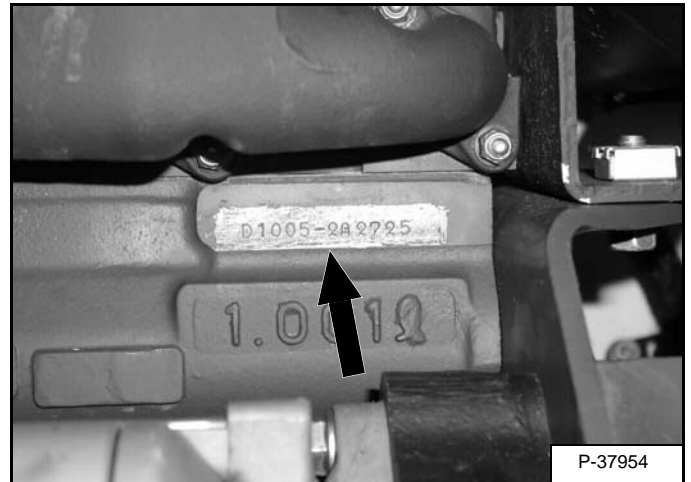

The engine serial number is located on the engine fuel injection pump [Figure 3].

DELIVERY REPORT

Figure 4

The Delivery Report must be filled out by the dealer and signed by the owner or operator when the Bobcat loader is delivered. An explanation of the form must be given to the owner. Make sure it is filled out completely [Figure 4].

◆ FACTORY OPTIONAL OR FIELD ACCESSORY (Not Standard Equipment)

* TIRES - Flotation tires (Optional) are shown. Bobcats are base-equipped with standard tires.

† BUCKET - Several different buckets and other attachments are available for the Bobcat loader.

● ROPS, FOPS - Roll Over Protective Structure, per SAE J1040 and ISO 3471, and Falling Object Protective Structure per SAEJ1043 and ISO 3449, Level I. Level II is available. The Bobcat loader is base-equipped with a standard operator cab as shown. Extra insulated cab is available as an option (Reduced noise level).

BOBCAT LOADER IDENTIFICATION

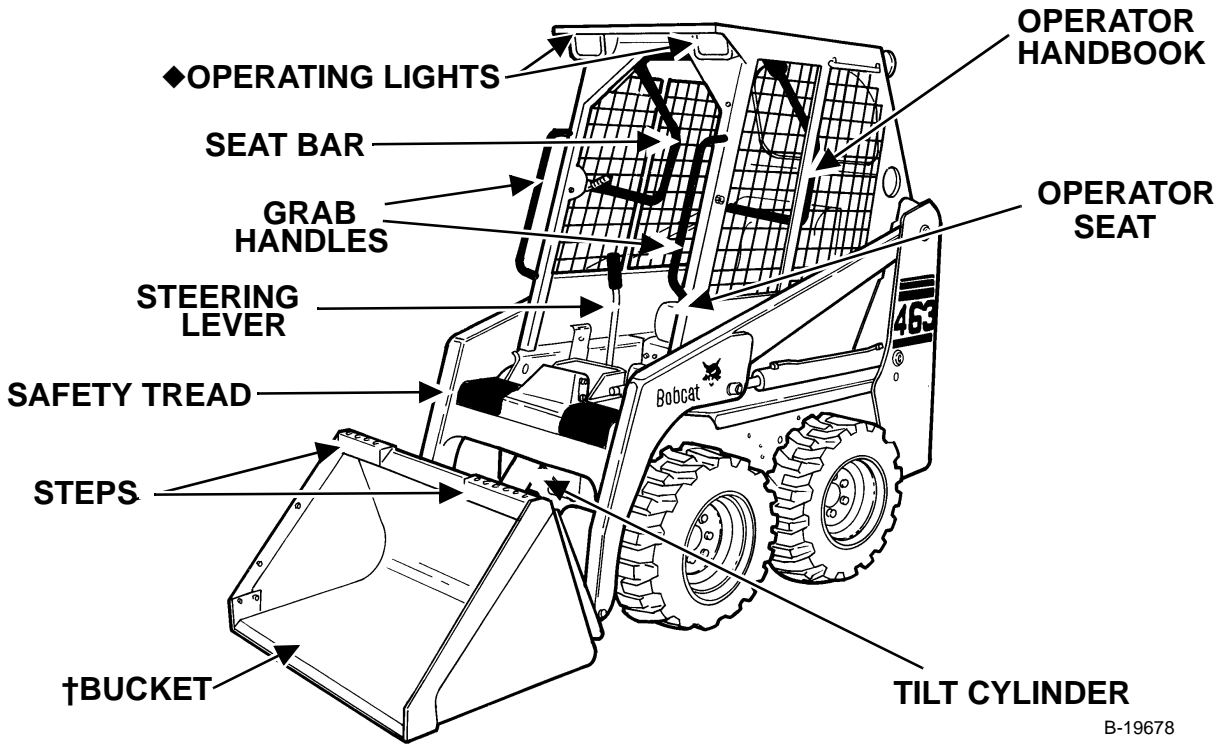

B-19678

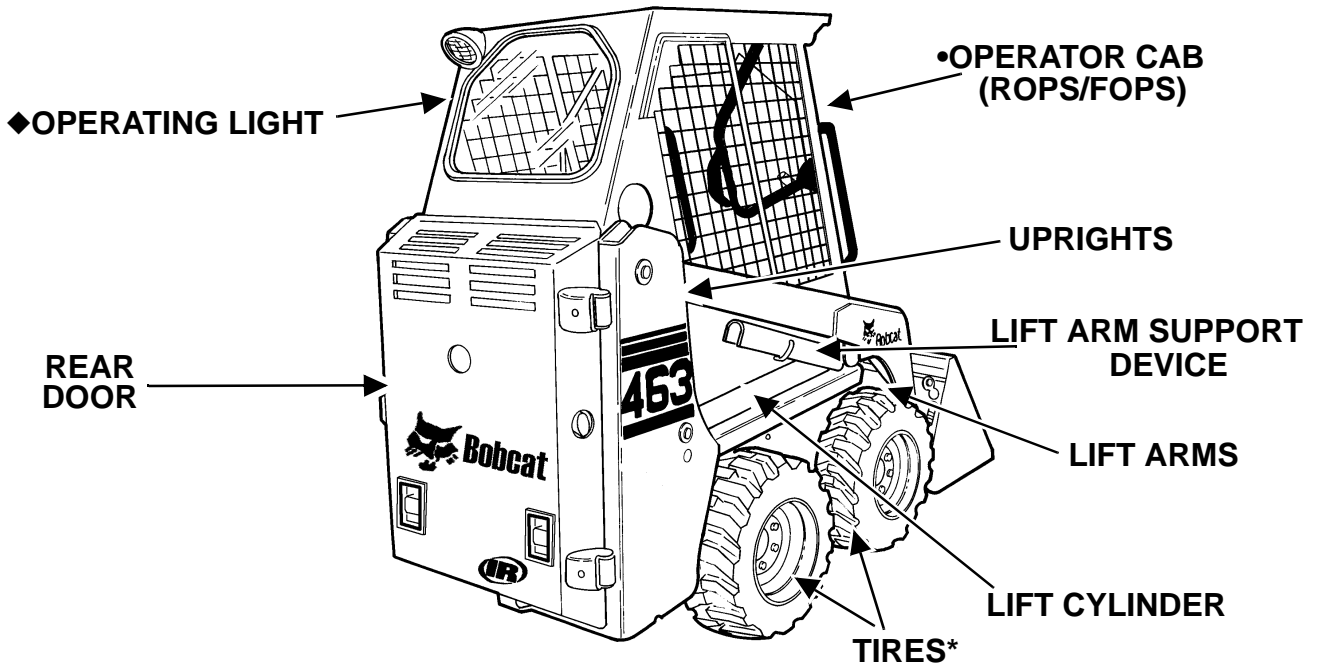

B-19679

SAFETY AND MAINTENANCE

SAFETY & MAINTENANCE

AIR CLEANER SERVICE	10-80-1
Replacing Filter Element	10-80-1
AUXILIARY CONTROL LOCKBOLT	10-140-1
Procedure	10-140-1
BOB-TACH	10-150-1
Inspection And Maintenance	10-150-1
ENGINE COOLING SYSTEM	10-90-1
Checking The Coolant Level	10-90-1
Cleaning The Cooling System	10-90-1
Replacing The Coolant	10-90-2
ENGINE LUBRICATION SYSTEM	10-110-1
Checking Engine Oil	10-110-1
Oil Chart	10-110-1
Replacing Oil And Filter	10-110-1
FINAL DRIVE TRANSMISSION (CHAINCASE)	10-130-1
Checking And Adding Oil	10-130-1
FUEL SYSTEM	10-100-1
Filling The Fuel Tank	10-100-1
Fuel Filter	10-100-3
Fuel Specification	10-100-1
Removing Air From The Fuel System	10-100-4
HYDRAULIC/HYDROSTATIC SYSTEM	10-120-1
Checking And Adding Fluid	10-120-1
Hydraulic/Hydrostatic Filter Replacement	10-120-2
Replacing The Hydraulic/Hydrostatic Fluid	10-120-2
LIFT ARM SUPPORT DEVICE	10-20-1
Disengaging The Lift Arm Support Device	10-20-2
Engaging The Lift Arm Support Device	10-20-1
LIFTING AND BLOCKING THE LOADER	10-10-1
Procedure	10-10-1
LUBRICATING THE LOADER	10-160-1
Procedure	10-160-1

Continued On Next Page

SAFETY AND MAINTENANCE (CONT'D)

OPERATOR CAB	10-30-1
Description	10-30-1
Emergency Exit	10-30-3
Lowering The Operator Cab	10-30-2
Raising The Operator Cab	10-30-1
PIVOT PINS	10-190-1
Procedure	10-190-1
REMOTE START	10-60-1
Procedure	10-60-1
SEAT BAR RESTRAINT SYSTEM	10-200-1
Foot Pedal Clean Out	10-200-2
Seat Bar Inspection	10-200-1
Seat Bar Maintenance	10-200-1
SERVICE SCHEDULE	10-70-1
Chart	10-70-1
SPARK ARRESTOR MUFFLER	10-180-1
Cleaning Procedure	10-180-1
TIRE MAINTENANCE	10-170-1
Tire Inflation	10-170-1
Tire Rotation	10-170-1
Wheel Nuts	10-170-1
TOWING THE LOADER	10-50-1
Procedure	10-50-1
TRANSPORTING THE LOADER	10-40-1
Adjusting The Bumper	10-40-1
Procedure	10-40-1

TIGHTEN ALL HARDWARE PER SIZE TO GRADE 5 TORQUE (SEE STANDARD TORQUE SPECIFICATIONS FOR BOLTS, SPEC SECTION) UNLESS OTHERWISE SPECIFIED.

LIFTING AND BLOCKING THE LOADER



Instructions are necessary before operating or servicing machine. Read and understand the Operation & Maintenance Manual, Handbook and signs (decals) on machine. Follow warnings and instructions in the manuals when making repairs, adjustments or servicing. Check for correct function after adjustments, repairs or service. Untrained operators and failure to follow instructions can cause injury or death [Figure 10-10-1].

W-2003-0199

Figure 10-10-1

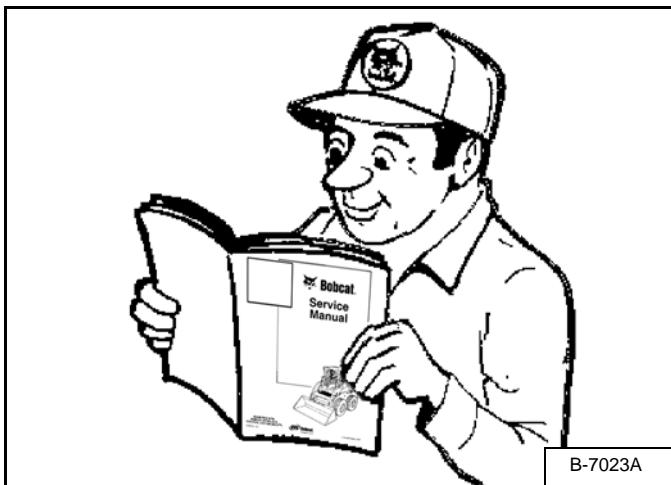

B-7023A

Procedure



Put jackstands under the front axles and rear corners of the frame before running the engine for service. Failure to use jackstands can allow the machine to fall or move and cause injury or death.

W-2017-0286

Figure 10-10-2



P-34920

Always park the loader on a level surface.

Put a floor jack under the rear of the loader [Figure 10-10-2].

Lift the rear of the loader and install jackstands [Figure 10-10-2].

Figure 10-10-3

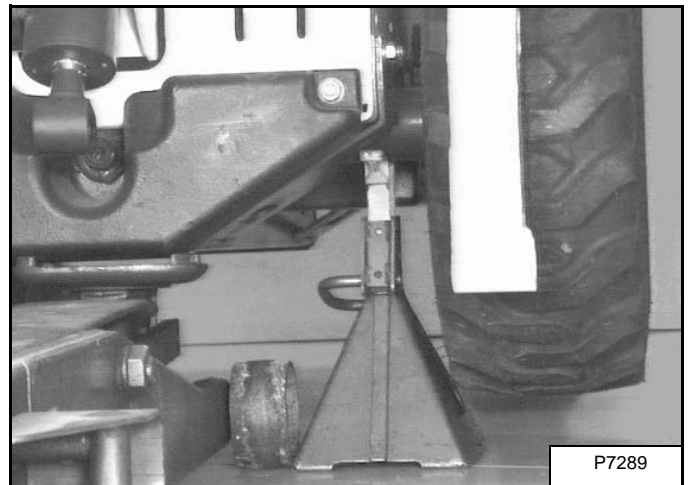

P7289

Put the floor jack under the front of the loader [Figure 10-10-3].

Lift the front of the loader and put jackstands under the loader frame.

NOTE: Make sure the jackstands do not touch the tires.

LIFT ARM SUPPORT DEVICE

Engaging The Lift Arm Support Device

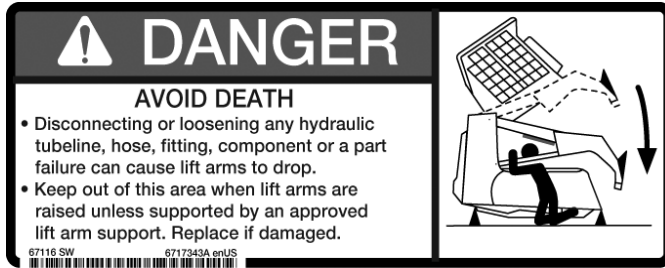

Never work on a machine with the lift arms up unless the lift arms are secured by an approved lift arm support device. Failure to use an approved lift arm support device can allow the lift arms or attachment to fall and cause injury or death.

W-2059-0598

Figure 10-20-1

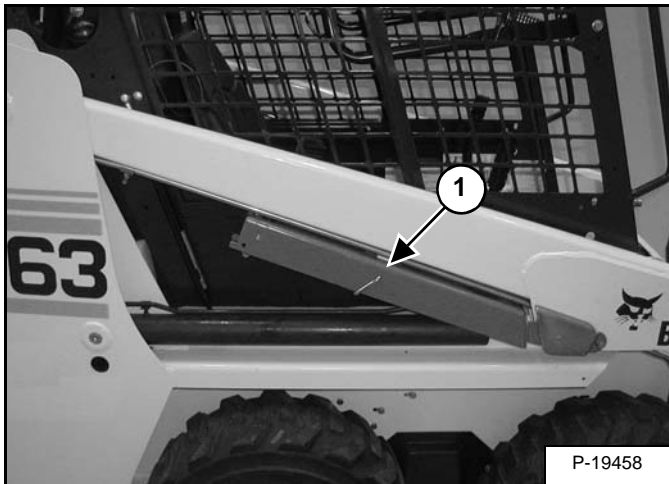

Put jackstands under the rear corners of the loader.

Disconnect the spring from the lift arm support device retaining pin (Item 1) [Figure 10-20-1], hold the support device and remove the retaining pin.

Figure 10-20-2

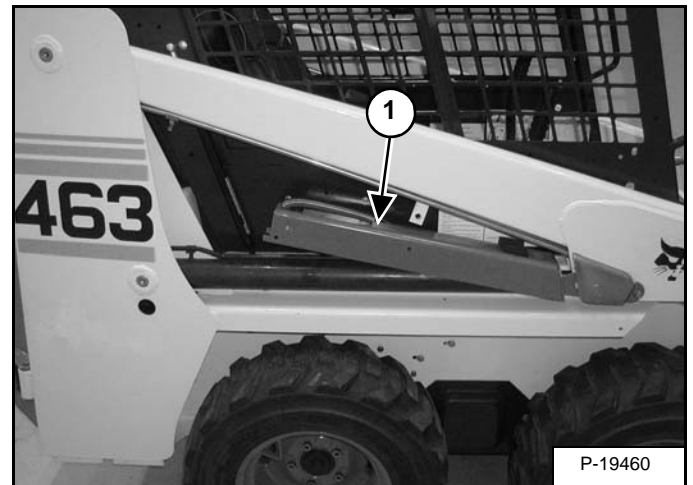

Lower the lift arm support device on top of the lift cylinder. Fasten the free end of the spring (Item 1) [Figure 10-20-2] to the lift arm support device so there will be no interference with the support device engagement.

With the operator in the seat, seat belt fastened and seat bar lowered, start the engine. Press the green *PRESS TO OPERATE* Button.

Figure 10-20-3

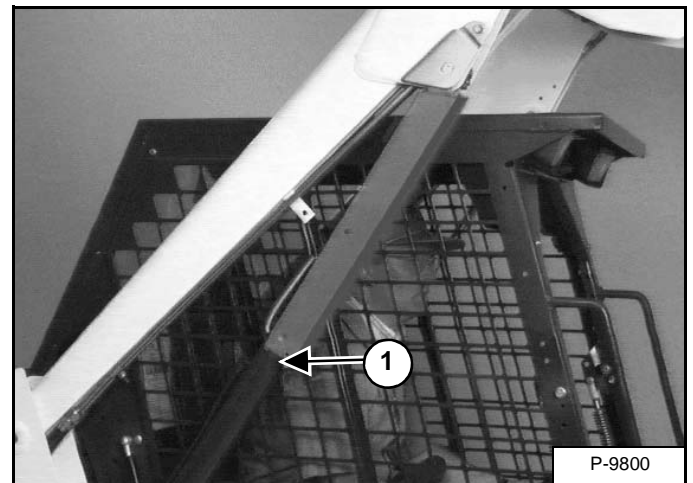

Raise the lift arms until the lift arm support device drops onto the lift cylinder (Item 1) [Figure 10-20-3].

Lower the lift arms slowly until the support device is held between the lift arm and the lift cylinder. Stop the engine. Raise the seat bar and move both pedals until both pedals lock.

LIFT ARM SUPPORT DEVICE (CONT'D)

Engaging The Lift Arm Support Device (Cont'd)

! WARNING

Service lift arm support device if damaged or if parts are missing. Using a damaged lift arm support or with missing parts can cause lift arms to drop causing injury or death.

W-2271-1197

Figure 10-20-4

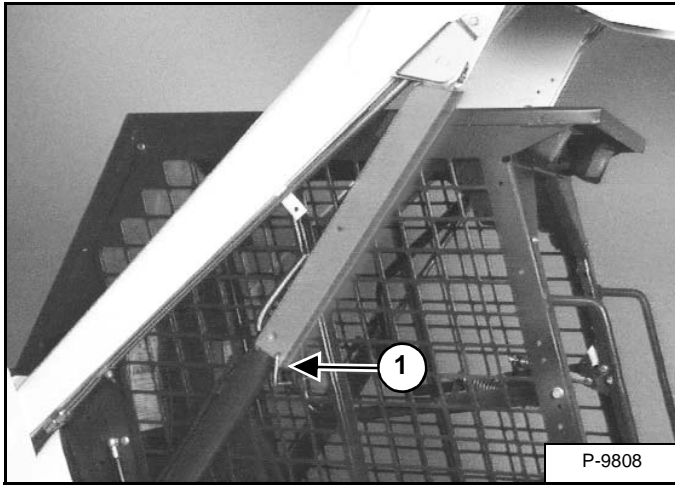

Install the retaining pin (Item 1) [Figure 10-20-4] into the rear of the lift arm support device below the cylinder rod.

Disengaging The Lift Arm Support Device

Figure 10-20-5

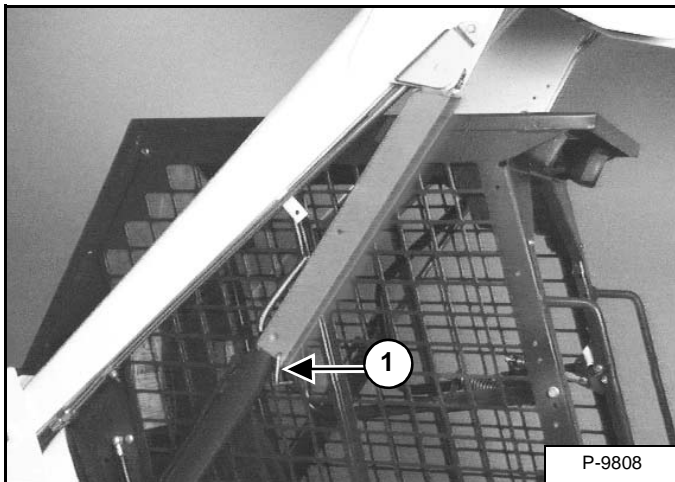

Remove the retaining pin (Item 1) [Figure 10-20-5] from the lift arm support device.

Figure 10-20-6

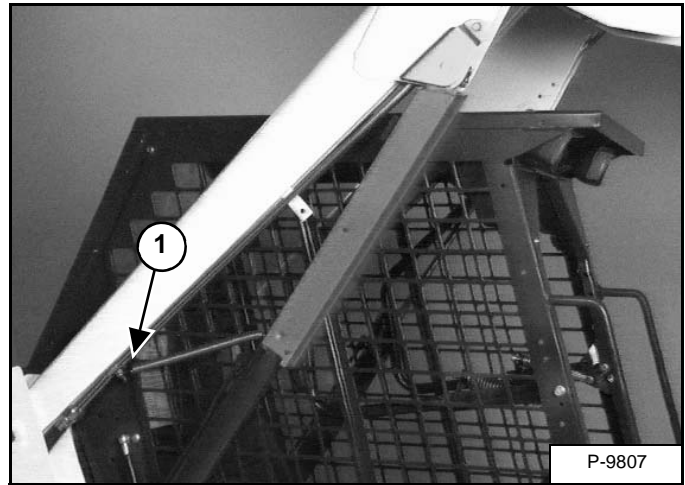

Connect the spring from the lift arm support device to the tubeline bracket (Item 1) [Figure 10-20-6] on the lift arms.

With the operator in the seat, seat belt fastened and seat bar lowered, start the engine. Press the green *PRESS TO OPERATE* Button.

Raise the lift arms a small amount and the spring will lift the support device off the lift cylinder rod. Lower the lift arms. Stop the engine.

Raise the seat bar and move pedals until both pedals lock.

Disconnect the spring from the bracket.

Figure 10-20-7



Raise the support device into storage position and insert pin through lift arm support device and bracket (Item 1) [Figure 10-20-7].

Connect spring to pin [Figure 10-20-7].

OPERATOR CAB

Description



Before the cab or the lift arms are raised for service, jackstands must be put under the rear corners of the frame. Failure to use jackstands can allow the machine to tip backward causing injury or death.

W-2014-0895

Figure 10-30-1

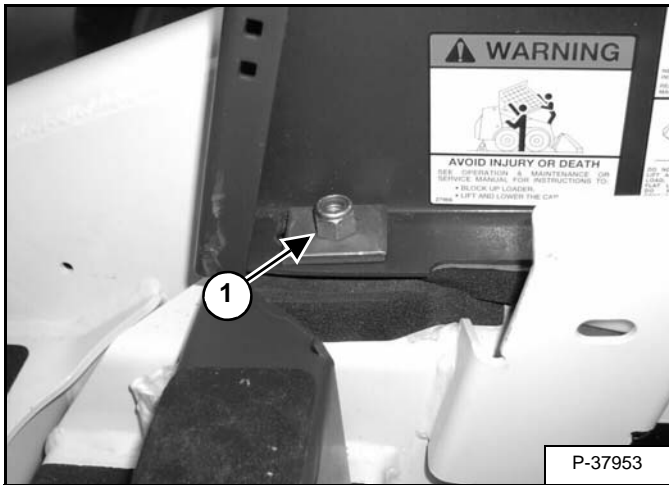

The Bobcat loader has an operator cab (ROPS and FOPS) as standard equipment to protect the operator from rollover and falling objects. Check with your dealer if the operator cab has been damaged. The seat belt must be worn for roll over protection.

ROPS/FOPS Roll Over Protective Structure per SAE J1040 and ISO 3471, and Falling Object Protective Structure per SAE J1043 and ISO 3449, Level 1.

Level 1 - Protection from falling bricks, small concrete blocks and hand tools encountered in operations such as highway maintenance, landscaping, and other construction site services.

Check with your dealer if the operator cab has been changed.

The operator cab fastening nuts (Item 1) [Figure 10-30-1] must be tightened to 40-50 ft.-lb. (54-68 N•m) torque.

Raising The Operator Cab

Stop the loader on a level surface. Put the lift arms all the way down.

Install jackstands under the rear of the loader frame.

Open the rear door. (See REAR DOOR on Page 50-70-1.)

If the lift arms must be up while raising the cab, install the lift arm support device. (See Engaging The Lift Arm Support Device on Page 10-20-1.)

Remove the two fasteners (Item 1) [Figure 10-30-1] at the front (both sides) of the operator cab.



Never modify operator cab by welding, grinding, drilling holes or adding attachments unless instructed to do so by Bobcat. Changes to the cab can cause loss of operator protection from rollover and falling objects, and result in injury or death.

W-2069-1299

Figure 10-30-2



Stand on the ground. Lift slowly until operator cab is all the way up [Figure 10-30-2].

The operator cab will lock in the raised position

OPERATOR CAB (CONT'D)

Lowering The Operator Cab

! WARNING

The cab must be held to prevent falling while hand is in access hole.

W-2205-0695

Figure 10-30-3

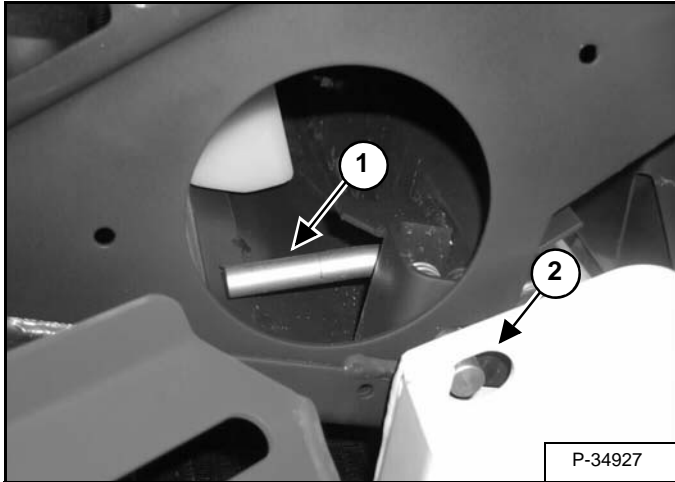
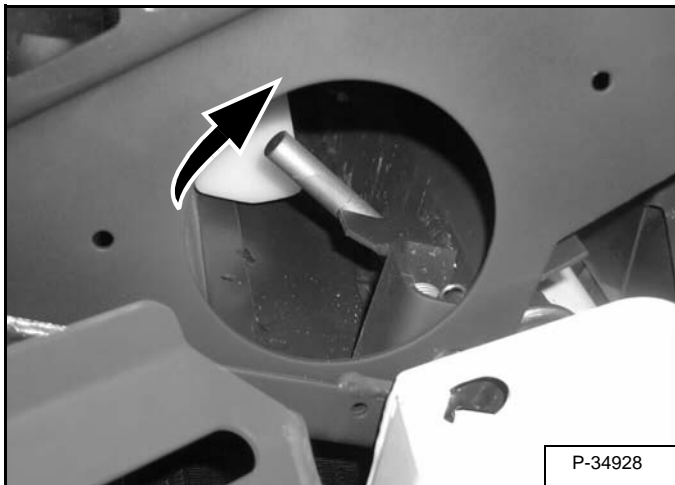

Figure 10-30-4



Hold the operator cab. Release the locking mechanism by pushing the lever (Item 1) [Figure 10-30-3] inward from the locked position and lifting the lever until it stays in the unlocked position [Figure 10-30-4].

The pin (Item 2) [Figure 10-30-3] must be retracted from the hole in the upright before lowering the operator cab.

REMOVE YOUR HAND FROM THE HOLE BEFORE LOWERING THE OPERATOR CAB

Stand on the ground and pull down on the operator cab.

Avoid slippery surfaces when lowering the cab.

NOTE: Guide the operator cab over the fastening bolts to prevent thread damage.

Figure 10-30-5

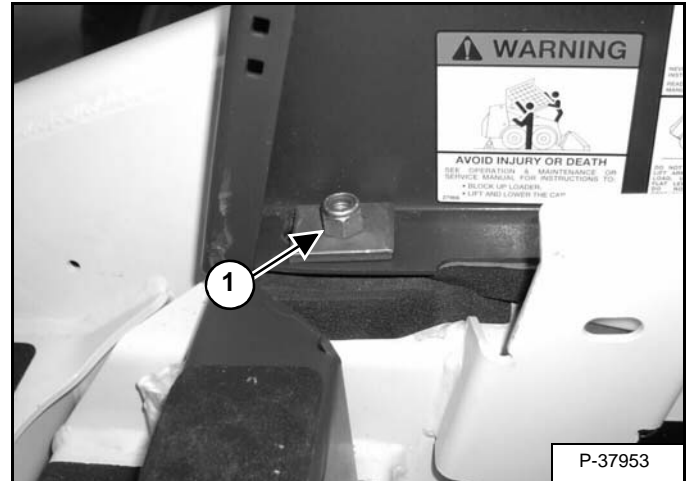

Install the cab washers and nuts. Tighten the nuts (Item 1) [Figure 10-30-5] (both sides) to 40-50 ft.-lb. (54-68 N•m) torque.

OPERATOR CAB (CONT'D)

Emergency Exit

The front opening on the operator cab and rear window provide exits.

Figure 10-30-6

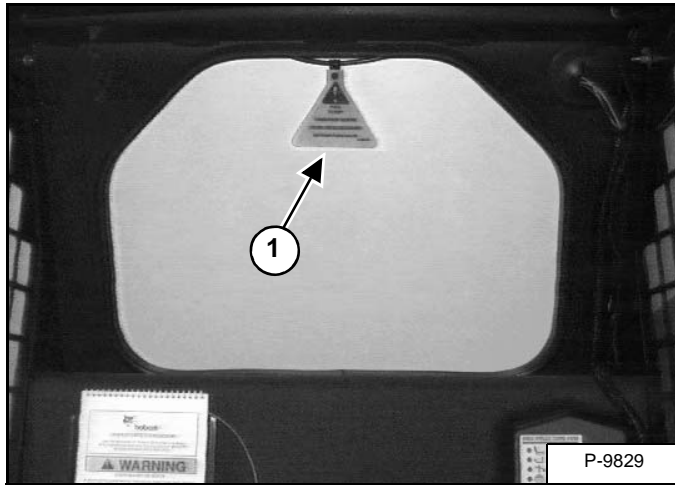

Pull on the tag (Item 1) **[Figure 10-30-6]** at the top of the rear window to remove the rubber cord.

Push the rear window out of the rear of the operator cab.

Figure 10-30-7



Exit through the rear of the cab **[Figure 10-30-7]**.

TRANSPORTING THE LOADER

Procedure



Adequately designed ramps of sufficient strength are needed to support the weight of the machine when loading onto a transport vehicle. Wood ramps can break and cause personal injury.

W-2058-0494

Figure 10-40-1

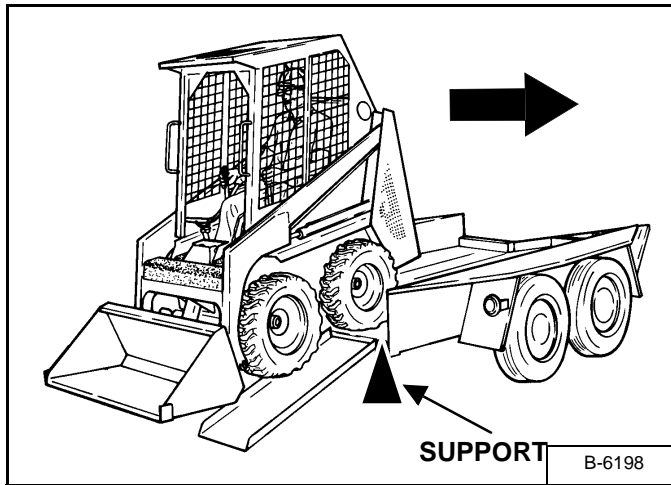

Be sure the transport and towing vehicles are of adequate size and capacity.

A loader with an empty bucket or no attachment must be loaded backward onto the transport vehicle [Figure 10-40-1].

The rear of the trailer must be locked or supported [Figure 10-40-1] when loading or unloading the loader to prevent the front end of the trailer from raising up.

Adjusting The Bumper

Figure 10-40-2

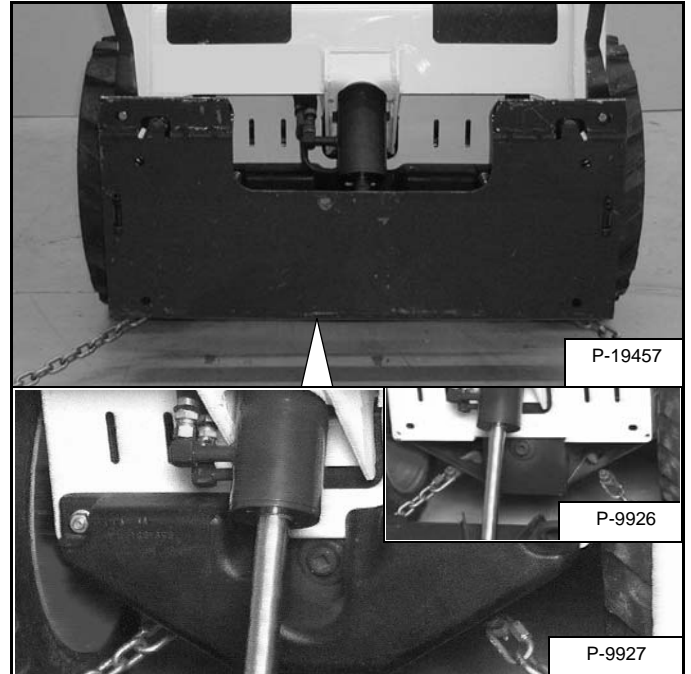

Use the following procedure to fasten the Bobcat loader to the transport vehicle to prevent the loader from moving during sudden stops or when going up or down slopes [Figure 10-40-2].

Fully lower any bucket or attachment. Stop the engine. Engage the parking brake.

Fasten chains at the front using the slots in the axle gussets [Figure 10-40-2]. The counterweight is removed (Inset) to show clarity. DO NOT operate the loader with counterweight removed.

Figure 10-40-3

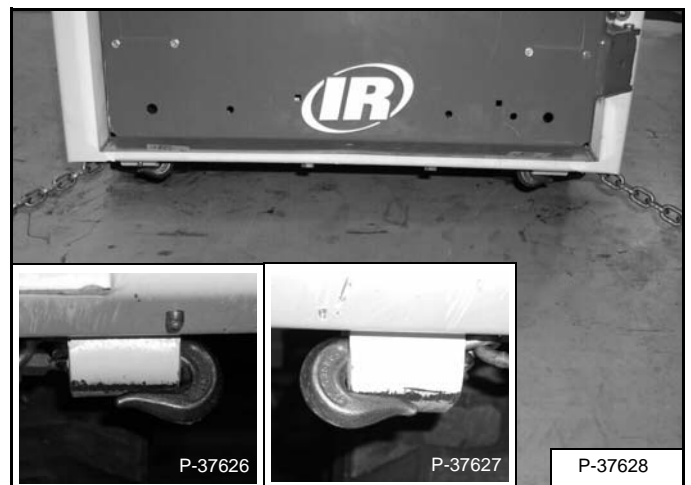

Fasten the rear of the loader as shown [Figure 10-40-3].

TOWING THE LOADER

Procedure

IMPORTANT

Do not push or pull the machine at more than 2 MPH (3,2 km/h) or for a distance of more than 25 feet (7,6 meters) with the towing tool in place.

I-2017-0389

Figure 10-50-1

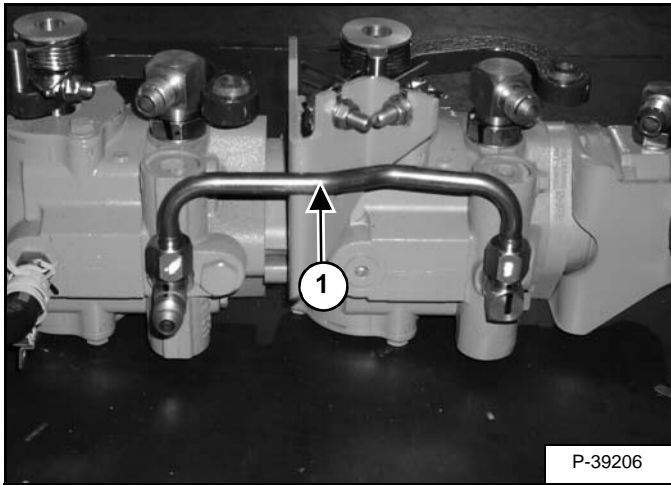

Be sure the transport and towing vehicles are of adequate size and capacity.

To prevent damage to the loader's hydrostatic system, a tow valve is available for towing the loader short distances at slow speeds. (Example: Moving the loader onto a transport vehicle.)

A tow valve is available from your dealer and must be installed before towing the loader.

Raise the operator cab. (See Raising The Operator Cab on Page 10-30-1.)

Clean the area around the hydrostatic pumps.

Remove the charge pressure tubeline and fittings (Item 1) [Figure 10-50-1] from the front side of the hydrostatic pumps.

Figure 10-50-2

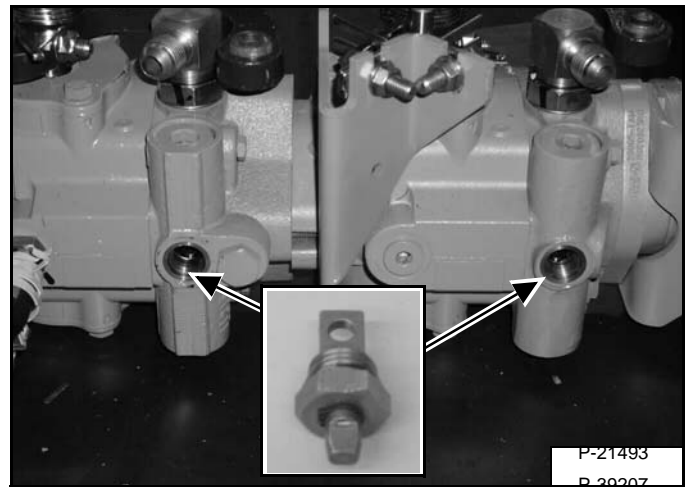

Install the tow valves in the fitting holes [Figure 10-50-2].

Figure 10-50-3

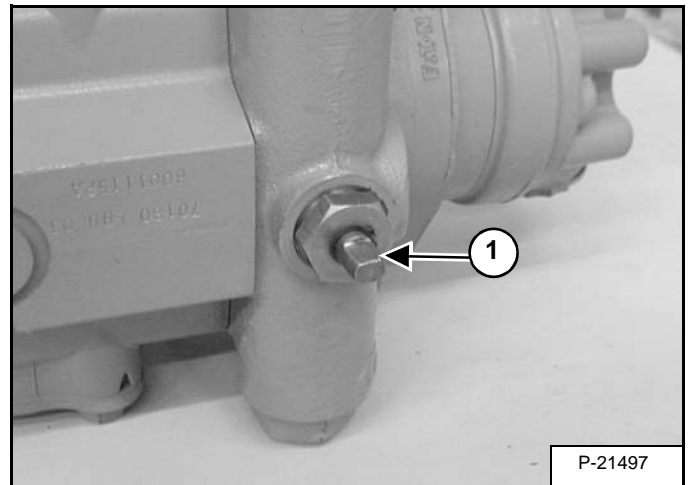

Tighten the jam nut (Item 1) [Figure 10-50-3] to 20-25 ft.-lb. (27-34 N•m) torque.

TOWING THE LOADER (CONT'D)

Procedure (Cont'd)

Figure 10-50-4

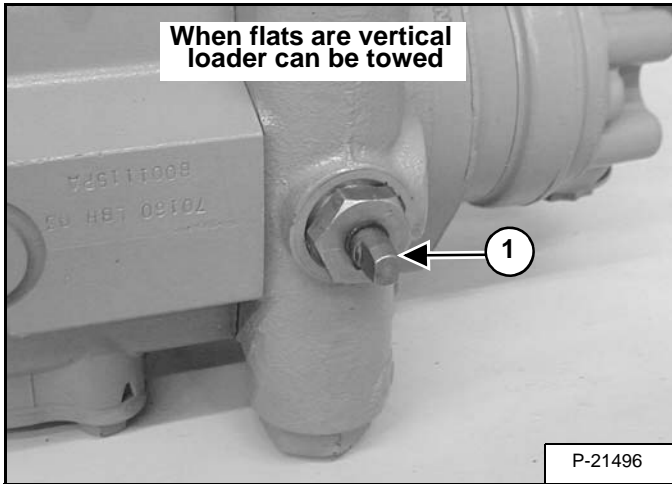

Turning the tow valves so the flats are vertical as shown (Item 1) [Figure 10-50-4] will release the relief valves and the check valves in the hydrostatic pumps and allow the loader to be moved.

The towing chain (or cable) must be rated at 1-1/2 times the weight of the loader. (See LOADER SPECIFICATIONS on Page SPEC-10-1.)

Turn the key switch to ON and press the traction lock override button.

If the electrical system is not functioning, contact your Bobcat loader dealer. (Part of the brake system must be disassembled to move the loader.)

Remove the tow valves and install the fittings and charge tubelines before operating the loader.

REMOTE START

Procedure

WARNING

Put jackstands under the front axles and rear corners of the frame before running the engine for service. Failure to use jackstands can allow the machine to fall or move and cause injury or death.

W-2017-0286

WARNING

Never work on a machine with the lift arms up unless the lift arms are secured by an approved lift arm support device. Failure to use an approved lift arm support device can allow the lift arms or attachment to fall and cause injury or death.

W-2059-0598

The tools listed will be needed to do the following procedure:

MEL1429-2 Remote Start Kit

6734387 Adapter Harness

The Remote Start is required when the operator cab is in the raised position for service or the service technician needs to start the engine.

The remote start is required when the service technician is adjusting the steering linkage and checking the hydraulic/hydrostatic system.

Lift and block the loader. (See Procedure on Page 10-10-1.)

Open the rear door of the loader.

Figure 10-60-1

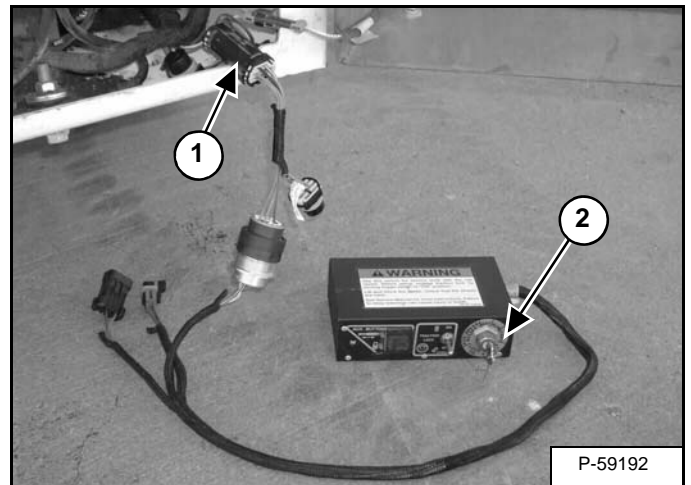

Remove the protective cap from the remote start connector on the loader.

Connect the adapter harness to the remote start and connect the adapter harness to the remote start connector (Item 1) [Figure 10-60-1].

Turn the key (Item 2) to start the engine.



Suggest:

If the above button click is invalid.

Please download this document

first, and then click the above link

to download the complete manual.

Thank you so much for reading

SERVICE SCHEDULE

Chart

Maintenance work must be done at regular intervals. Failure to do so will result in excessive wear and early failures. The service schedule is a guide for correct maintenance of the Bobcat loader.

 <b style="font-size: 24pt; margin-left: 10px;">WARNING	<p>Instructions are necessary before operating or servicing machine. Read and understand the Operation & Maintenance Manual and signs (decals) on machine. Follow warnings and instructions in the manuals when making repairs, adjustments or servicing. Check for correct function after adjustments, repairs or service. Untrained operators and failure to follow instructions can cause injury or death.</p> <p style="text-align: right; font-size: 10pt;">W-2003-1285</p>
--	---

SERVICE SCHEDULE		HOURS					
ITEM	SERVICE REQUIRED	8-10	50	100	250	500	■1000
Engine Air Cleaner	Empty the dust cup & replace the filter as needed.						
Engine Oil	Check the engine oil level and add oil as needed.						
Engine Cooling System	Clean debris from oil cooler, radiator and grill. Check coolant level in recovery tank. Add coolant as needed.						
Tires	Check for damaged tires and correct air pressure.						
Indicators, Gauges, & Lights (Opt.)	Check for correct operation of all indicators, gauges & lights (Opt.).						
Seat Belt, Seat Bar	Check the condition of the seat belt. Check the seat bar & pedal interlocks for correct operation. Clean dirt and debris from moving parts.						
Safety Signs (Decals) and Safety Tread	Check for damaged sign (decals) and safety treads. Replace any signs or safety treads that are damaged or worn.						
Lift Arms and Bob-Tach Pivot Pins and Wedges	Lubricate with multi-purpose lithium based grease.						
Engine Fuel Filter	Remove the water from the filter.						
Hydraulic Fluid, Hoses and Tubelines	Check fluid level and add as needed. Check for damage and leaks. Repair or replace as needed.						
Bobcat Interlock Control System (BICS™)	Check BICS™ System Controller functions. Clean dirt, debris or objects from under or behind seat as required.						
Battery	Check cables, connections and electrolyte level. Add distilled water as needed.						
Control Pedals & Steering	Check for correct operation. Repair or adjust as needed.						
Bob-Tach	Check locking levers & wedges for condition & operation.						
Wheel Nuts	<input type="checkbox"/> Check for loose wheel nuts & tighten to 40-45 ft.-lb. (54-61 N•m) torque.						
Parking Brake	Check operation.						
Alternator Belt	Check belt tension and adjust as needed.						
Engine Oil and Filter	Replace oil and filter. (See Oil Chart on Page 10-110-1.)						
Hydraulic Filter Element	Replace Filter Element.						
Spark Arrestor Muffler	Clean the spark chamber.						
Drive Belt	Clean the spark chamber.						
Steering Lever Pivots	Lubricate grease fittings and oil hole in the steering shaft.						
Engine Fuel Filter	Replace the filter element.						
Hydraulic Reservoir Breather	Replace the breather cap.						
Final Drive Trans (Chain-case)	Replace the fluid.						
Hydraulic/Hydrostatic Reservoir	•Replace the fluid.						

- Check wheel nut torque every 8 hours for the first 24 hours.
- Also replace hydraulic/hydrostatic filter element when the transmission warning light stays on for five minutes after the hydraulic fluid is at operating temperature.
- Or every 12 months.

<https://www.ebooklibonline.com>

Hello dear friend!

Thank you very much for reading.

Enter the link into your browser.

The full manual is available for immediate download.

<https://www.ebooklibonline.com>