

**463**



**Bobcat®**

# Service Manual

**S/N 52001100 & Above**  
**S/N 519911001 & Above**



**EQUIPPED WITH  
BOBCAT INTERLOCK  
CONTROL SYSTEM (BICS™)**



Printed in U.S.A.

# MAINTENANCE SAFETY



## WARNING

Instructions are necessary before operating or servicing machine. Read and understand the Operation & Maintenance Manual, Operator's Handbook and signs (decals) on machine. Follow warnings and instructions in the manuals when making repairs, adjustments or servicing. Check for correct function after adjustments, repairs or service. Untrained operators and failure to follow instructions can cause injury or death.

W-2003-0903



**Safety Alert Symbol:** This symbol with a warning statement, means: "Warning, be alert! Your safety is involved!" Carefully read the message that follows.

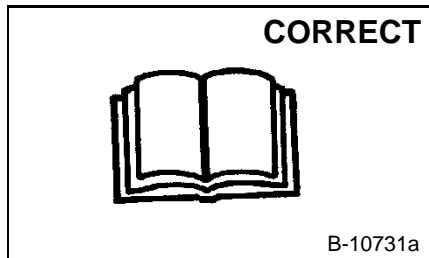

B-10731a

⚠ Never service the Bobcat Skid-Steer Loader without instructions.

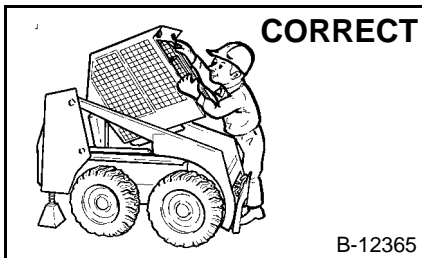

B-12365

⚠ Use the correct procedure to lift or lower operator cab.

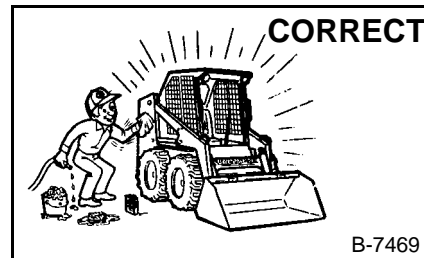

B-7469

⚠ Cleaning and maintenance are required daily.

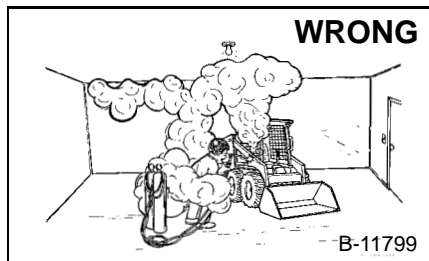

B-11799

⚠ Have good ventilation when welding or grinding painted parts.  
 ⚠ Wear dust mask when grinding painted parts. Toxic dust and gas can be produced.  
 ⚠ Avoid exhaust fume leaks which can kill without warning. Exhaust system must be tightly sealed.

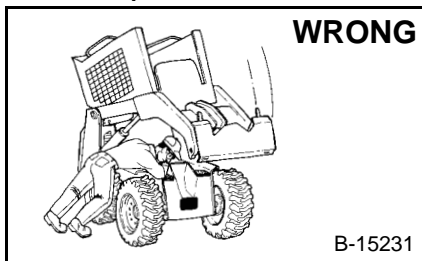

B-15231

⚠ Disconnecting or loosening any hydraulic tubeline, hose, fitting, component or a part failure can cause lift arms to drop. Do not go under lift arms when raised unless supported by an approved lift arm support device. Replace it if damaged.

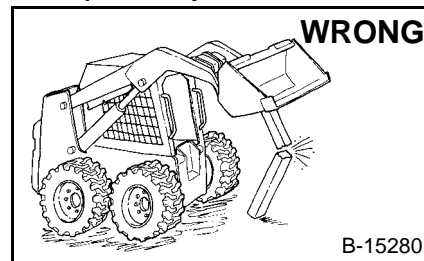

B-15280

⚠ Never work on loader with lift arms up unless lift arms are held by an approved lift arm support device. Replace if damaged.  
 ⚠ Never modify equipment or add attachments not approved by Bobcat Company.

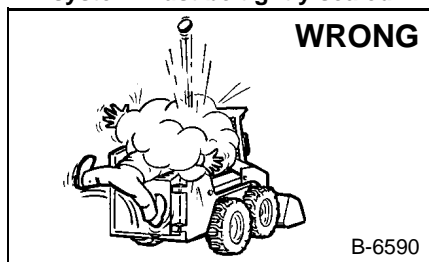

B-6590

⚠ Stop, cool and clean engine of flammable materials before checking fluids.  
 ⚠ Never service or adjust loader with the engine running unless instructed to do so in the manual.  
 ⚠ Avoid contact with leaking hydraulic fluid or diesel fuel under pressure. It can penetrate the skin or eyes.  
 ⚠ Never fill fuel tank with engine running, while smoking or when near open flame.

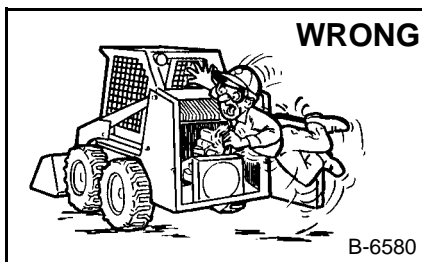

B-6580

⚠ Keep body, jewelry and clothing away from moving parts, electrical contact, hot parts and exhaust.  
 ⚠ Wear eye protection to guard from battery acid, compressed springs, fluids under pressure and flying debris when engines are running or tools are used. Use eye protection approved for type of welding.  
 ⚠ Keep rear door closed except for service. Close and latch door before operating the loader.

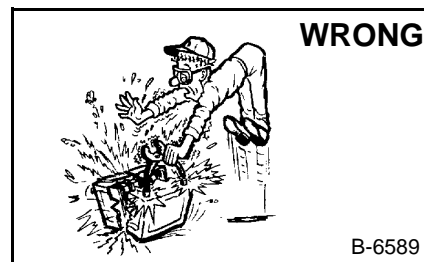

B-6589

⚠ Lead-acid batteries produce flammable and explosive gases.  
 ⚠ Keep arcs, sparks, flames and lighted tobacco away from batteries.  
 ⚠ Batteries contain acid which burns eyes or skin on contact. Wear protective clothing. If acid contacts body, flush well with water. For eye contact flush well and get immediate medical attention.

Maintenance procedures which are given in the Operation & Maintenance Manual can be performed by the owner/operator without any specific technical training. Maintenance procedures which are **not** in the Operation & Maintenance Manual must be performed **ONLY BY QUALIFIED BOBCAT SERVICE PERSONNEL**. Always use genuine Bobcat replacement parts. The Service Safety Training Course is available from your Bobcat dealer.

MSW01-0805

## ALPHABETICAL INDEX

AIR CLEANER .....	70-01	LIFTING AND BLOCKING THE LOADER.....	10-01
AIR CLEANER SERVICE .....	10-01	LIGHTS.....	60-01
ALTERNATOR .....	60-01	LUBRICATING THE LOADER.....	10-01
AUXILIARY CONTROL LOCKBOLT .....	10-01		
		MAIN RELIEF VALVE .....	20-01
BATTERY .....	60-01	MUFFLER.....	70-01
BICST <sup>™</sup> (With Press To Operate Button) .....	60-01		
BICST <sup>™</sup> BLOCK VALVE .....	20-01	OPERATOR CAB .....	10-01, 50-01
BICST <sup>™</sup> SYSTEM CONTROLLER.....	60-01	OPERATOR SEAT .....	20-01
BOB-TACH.....	10-01, 50-01		
		PARKING BRAKE.....	40-01
CHARGE PRESSURE .....	30-01	PIVOT PINS .....	10-01
CHAINCASE .....	40-01		
CONTROLS .....	20-01	RADIATOR .....	70-01
CONTROL PANEL .....	30-01	REAR DOOR.....	50-01
CONVERSIONS .....	SPEC-01	REAR WINDOW .....	50-01
CYLINDER .....	20-01	REMOTE START SWITCH .....	10-01
		RECONDITIONING THE ENGINE.....	70-01
DRIVE BELT .....	30-01		
DRIVE COMPONENTS .....	40-01	SEAT BAR .....	50-01
		SEAT BAR RESTRAINT SYSSTEM.....	40-01
ELECTRICAL SYSTEM INFORMATION .....	60-01	SEAT BAR SENSOR .....	60-01
ENGINE .....	70-01	SERVICE SCHEDULE .....	10-01
ENGINE COMPONENTS AND TESTING .....	70-01	SPARK ARRESTOR MUFFLER.....	10-01
ENGINE COOLING SYSTEM.....	10-01	STARTER .....	60-01
ENGINE LUBRICATION SYSTEM.....	10-01	STEERING .....	30-01
ENGINE MOUNTING BRACKET .....	70-01		
ENGINE SPECIFICATIONS.....	SPEC-01	TIRE MAINTENANCE .....	10-01
ENGINE SPEED CONTROL .....	70-01	TOWING THE LOADER .....	10-01
		THERMOSTAT .....	70-01
FAN .....	70-01	TORQUE SPECIFICATIONS FOR BOLTS .....	SPEC-01
FINAL DRIVE TRANSMISSION (CHAINCASE).....	10-01	TRACTION LOCK .....	60-01
FLYWHEEL .....	70-01	TRANSPORTING THE LOADER .....	10-01
FUEL LIFT PUMP .....	70-01	TROUBLESHOOTING .....	70-01
FUEL SYSTEM .....	10-01		
FUEL TANK.....	50-01		
GLOWPLUGS .....	70-01		
HYDRAULIC CONNECTION SPEC .....	SPEC-01		
HYDRAULIC CONTROL VALVE .....	20-01		
HYDRAULIC FILTER .....	20-01		
HYDRAULIC/HYDROSTATIC			
FLUID SPECIFICATIONS .....	SPEC-01		
HYDRAULIC/HYDROSTATIC SYSTEM .....	10-01		
HYDRAULIC PUMP.....	20-01		
HYDRAULIC RESERVOIR .....	20-01		
HYDRAULIC SYSTEM INFORMATION.....	20-01		
HYDROSTATIC MOTOR .....	30-01		
HYDROSTATIC PUMP .....	30-01		
HYDROSTATIC SYSTEM INFORMATION .....	30-01		
INSTRUMENT PANEL .....	60-01		
LIFT ARM SUPPORT DEVICE.....	10-01		
LIFT ARMS .....	50-01		

**<https://www.ebooklibonline.com>**

Hello dear friend!

Thank you very much for reading.

Enter the link into your browser.

The full manual is available for immediate download.

**<https://www.ebooklibonline.com>**

# CONTENTS

FOREWORD.....	II
SAFETY INSTRUCTIONS .....	V
SERIAL NUMBER LOCATIONS .....	IX
DELIVERY REPORT.....	IX
BOBCAT SKID STEER LOADER IDENTIFICATION .....	X
SAFETY AND MAINTENANCE.....	10-01
HYDRAULIC SYSTEM .....	20-01
HYDROSTATIC SYSTEM.....	30-01
DRIVE SYSTEM .....	40-01
MAIN FRAME .....	50-01
ELECTRICAL SYSTEM & ANALYSIS.....	60-01
ENGINE SERVICE .....	70-01
SPECIFICATIONS.....	SPEC-01

**SAFETY AND  
MAINTENANCE**

**HYDRAULIC  
SYSTEM**

**HYDROSTATIC  
SYSTEM**

**DRIVE  
SYSTEM**

**MAIN  
FRAME**

**ELECTRICAL  
SYSTEM AND  
ANALYSIS**

**ENGINE  
SERVICE**

**SPECIFICATIONS**

**CALIFORNIA  
PROPOSITION 65 WARNING**

Diesel engine exhaust and some of its constituents are known to the State of California to cause cancer, birth defects and other reproductive harm.

# FOREWORD

This manual is for the Bobcat loader excavator mechanic. It provides necessary servicing and adjustment procedures for the Bobcat loader and its component parts and systems. Refer to the Operation & Maintenance Manual for operating instructions, starting procedure, daily checks, etc.

A general inspection of the following items must be made after the loader has had service or repair:

1. Check that the ROPS/FOPS (Including side screens) is in good condition and is not modified.

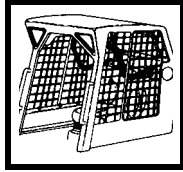

9. The parking brake must function correctly.



2. Check that ROPS mounting hardware is tightened and is Melroe approved.



10. Enclosure door latches must open and close freely.

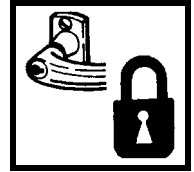

3. The seat belt must be correctly installed, functional and in good condition.

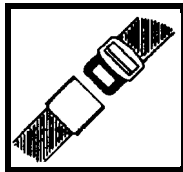

11. Bob-Tach wedges and linkages must function correctly and be in good condition.

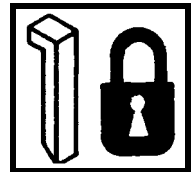

4. The seat bar and pedal interlocks must be correctly adjusted, clean and lubricated.

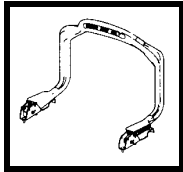

12. Safety treads must be in good condition.

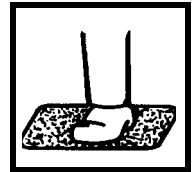

5. Check lift arm support device, replace if damaged.

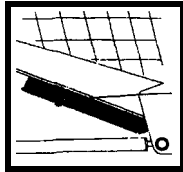

13. Check for correct function of indicator lamps (Optional on some models).

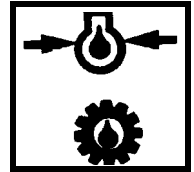

6. Machine signs must be legible and in the correct location.



14. Check hydraulic fluid level, engine oil level and fuel supply.

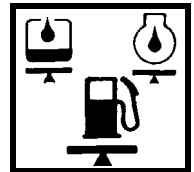

7. Steering levers and foot pedals must return to neutral.

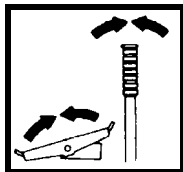

15. Inspect for fuel, oil or hydraulic fluid leaks.

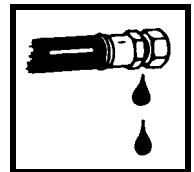

8. Check for correct function of the work lights.



16. Lubricate the loader.

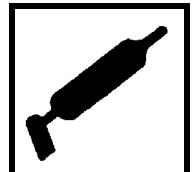

17. Check the condition of the battery and cables.

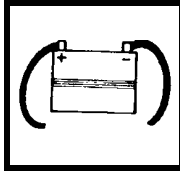

Recommend to the owner that all necessary corrections be made before the machine is returned to service.



18. Inspect the air cleaner for damage or leaks. Check the condition of the element.

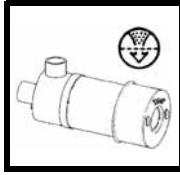

19. Check the electrical charging system.

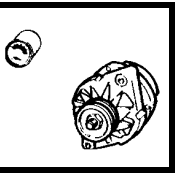

20. Check tires for wear and pressure.

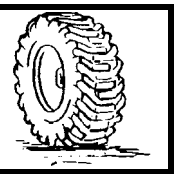

21. Inspect for loose or broken parts or connections.

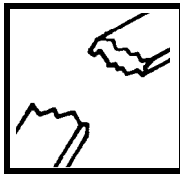

22. Operate the loader and check all functions.

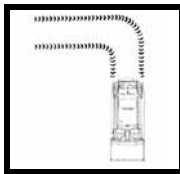

23. Check for any field modification not completed.



24. Check for correct function of the Bobcat Interlock Control System (BICS™) before the machine is returned to the customer.

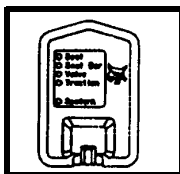

## SAFETY INSTRUCTIONS



### Safety Alert Symbol

This symbol with a warning statement means:  
“Warning, be alert! Your safety is involved!”  
Carefully read the message that follows.



## WARNING

Instructions are necessary before operating or servicing machine. Read and understand the Operation & Maintenance Manual, Operator's Handbook and signs (decals) on machine. Follow warnings and instructions in the manuals when making repairs, adjustments or servicing. Check for correct function after adjustments, repairs or service. Untrained operators and failure to follow instructions can cause injury or death.

W-2003-0903



## WARNING

Warnings on the machine and in the manuals are for your safety. Failure to obey warnings can cause injury or death.

W-2044-1285

## IMPORTANT

This notice identifies procedures which must be followed to avoid damage to the machine.

I-2019-0284

The following publications provide information on the safe use and maintenance of the Bobcat machine and attachments:

- The Delivery Report is used to assure that complete instructions have been given to the new owner and that the machine is in safe operating condition.
- The Operation & Maintenance Manual delivered with the machine or attachment contains operating information as well as routine maintenance and service procedures. It is a part of the machine and can be stored in a container provided on the machine. Replacement Operation & Maintenance Manuals can be ordered from your Bobcat dealer.
- Machine signs (decals) instruct on the safe operation and care of your Bobcat machine or attachment. The signs and their locations are shown in the Operation & Maintenance Manual. Replacement signs are available from your Bobcat dealer.
- An Operator's Handbook fastened to the operator cab. It's brief instructions are convenient to the operator. The handbook is available from your dealer in an English edition or one of many other languages. See your Bobcat dealer for more information on translated versions.
- The AEM Safety Manual delivered with the machine gives general safety information.
- The Service Manual and Parts Manual are available from your dealer for use by mechanics to do shop-type service and repair work.
- The Skid-Steer Loader Operator Training Course is available through your local dealer or at [www.training.bobcat.com](http://www.training.bobcat.com) or [www.bobcat.com](http://www.bobcat.com). This course is intended to provide rules and practices of correct operation of the Skid-Steer Loader. The course is available in English and Spanish versions.
- Service Safety Training Courses are available from your Bobcat dealer or at [www.training.bobcat.com](http://www.training.bobcat.com) or [www.bobcat.com](http://www.bobcat.com). They provide information for safe and correct service procedures.
- The Skid-Steer Loader Safety Video is available from your Bobcat dealer or at [www.training.bobcat.com](http://www.training.bobcat.com) or [www.bobcat.com](http://www.bobcat.com).

SI SSL-0206 SM

## SAFETY INSTRUCTIONS (CONT'D)

### Fire Prevention

The machine and attachments have components that are at high temperature under normal operating conditions. The primary source of high temperatures is the engine and exhaust system. The electrical system, if damaged or incorrectly maintained, can be a source of arcs or sparks.

Flammable debris (leaves, straw, etc.) must be removed regularly. If flammable debris is allowed to accumulate, it will increase fire hazard. Clean often to avoid this accumulation. Flammable debris in the engine compartment is a potential hazard.

The spark arrestor muffler is designed to control the emission of hot particles from the engine and exhaust system, but the muffler and the exhaust gases are still hot.

- Do not use the machine where exhaust, arcs, sparks or hot components can contact flammable material, explosive dust or gases.
- The operator cab, engine compartment, and engine cooling system must be inspected every day and cleaned if necessary to prevent fire hazard and overheating.
- Check all electrical wiring and connections for damage. Keep the battery terminals clean and tight. Repair or replace any damaged part.
- Check fuel and hydraulic tubes, hoses and fittings for damage and leakage. Never use open flame or bare skin to check for leaks. Tighten or replace any parts that show leakage. Always clean fluid spills. Do not use gasoline or diesel fuel for cleaning parts. Use commercial nonflammable solvents.
- Do not use ether or starting fluids on any engine which has glow plugs. These starting aids can cause explosion and injure you or bystanders.
- Always clean the machine, disconnect the battery, and disconnect the wiring from the controllers before welding. Cover rubber hoses, battery and all other flammable parts. Keep a fire extinguisher near the machine when welding. Have good ventilation when grinding or welding painted parts. Wear a dust mask when grinding painted parts. Toxic dust or gas can be produced.
- Stop the engine and let it cool before adding fuel. **NO SMOKING!**

- Use the procedure in the Operation & Maintenance Manual for connecting the battery and for jump starting.
- Use the procedure in the Operation & Maintenance Manual for cleaning the spark arrestor muffler (if equipped).

Figure 1

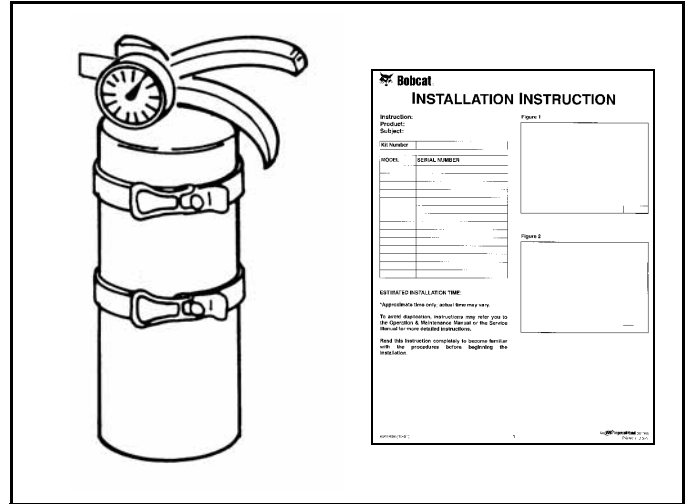

- Know where fire extinguishers and first aid kits are located and how to use them. Fire extinguishers are available from your Bobcat dealer [Figure 1].

## SERIAL NUMBER LOCATIONS

Always use the serial number of the loader when requesting service information or when ordering parts. Early or later models (identification made by serial number) may use different parts, or it may be necessary to use a different procedure in doing a specific service operation.

### Bobcat Loader Serial Number

Figure 2

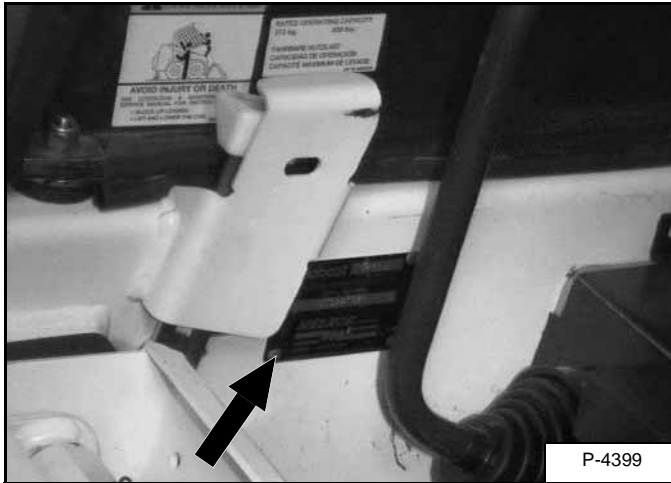

The loader serial number plate is located on the inside of the operator cab on the right fender and in front of the seat [Figure 2].

Explanation of loader Serial Number:

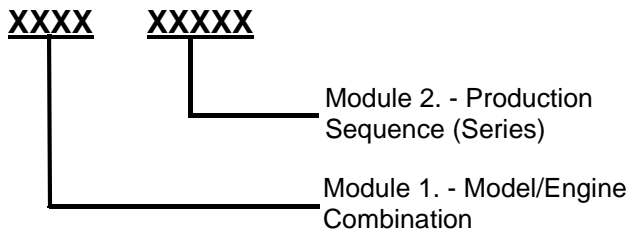

### Engine Serial Number

Figure 3

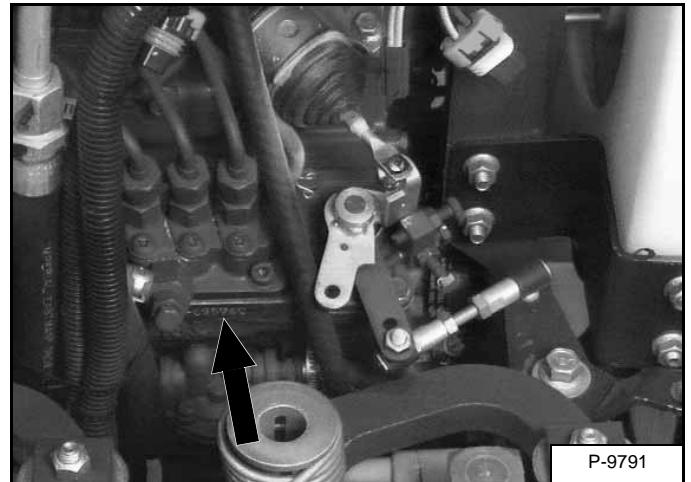

The engine serial number is located on the engine fuel injection pump [Figure 3].

### DELIVERY REPORT

Figure 4

The Delivery Report must be filled out by the dealer and signed by the owner or operator when the Bobcat loader is delivered. An explanation of the form must be given to the owner. Make sure it is filled out completely [Figure 4].

**BOBCAT SKID STEER LOADER IDENTIFICATION**

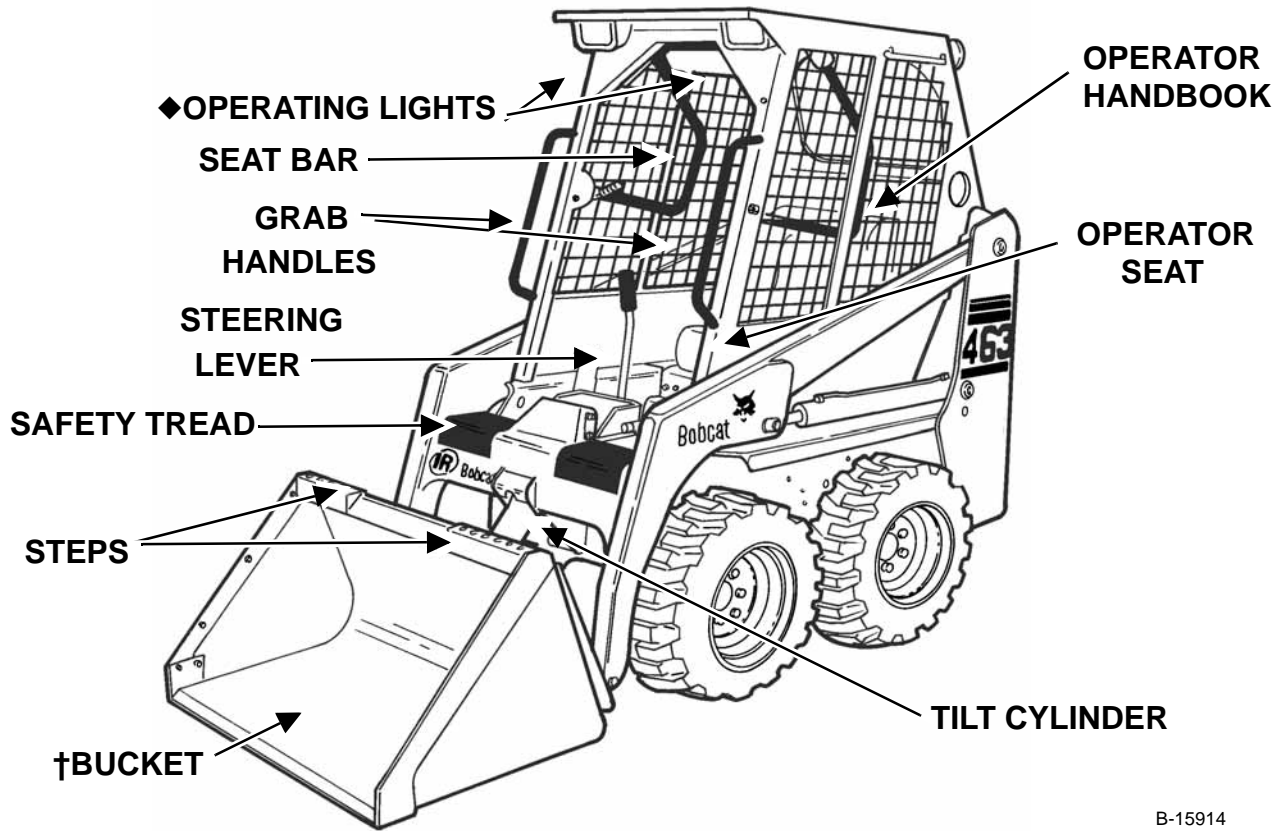

B-15914

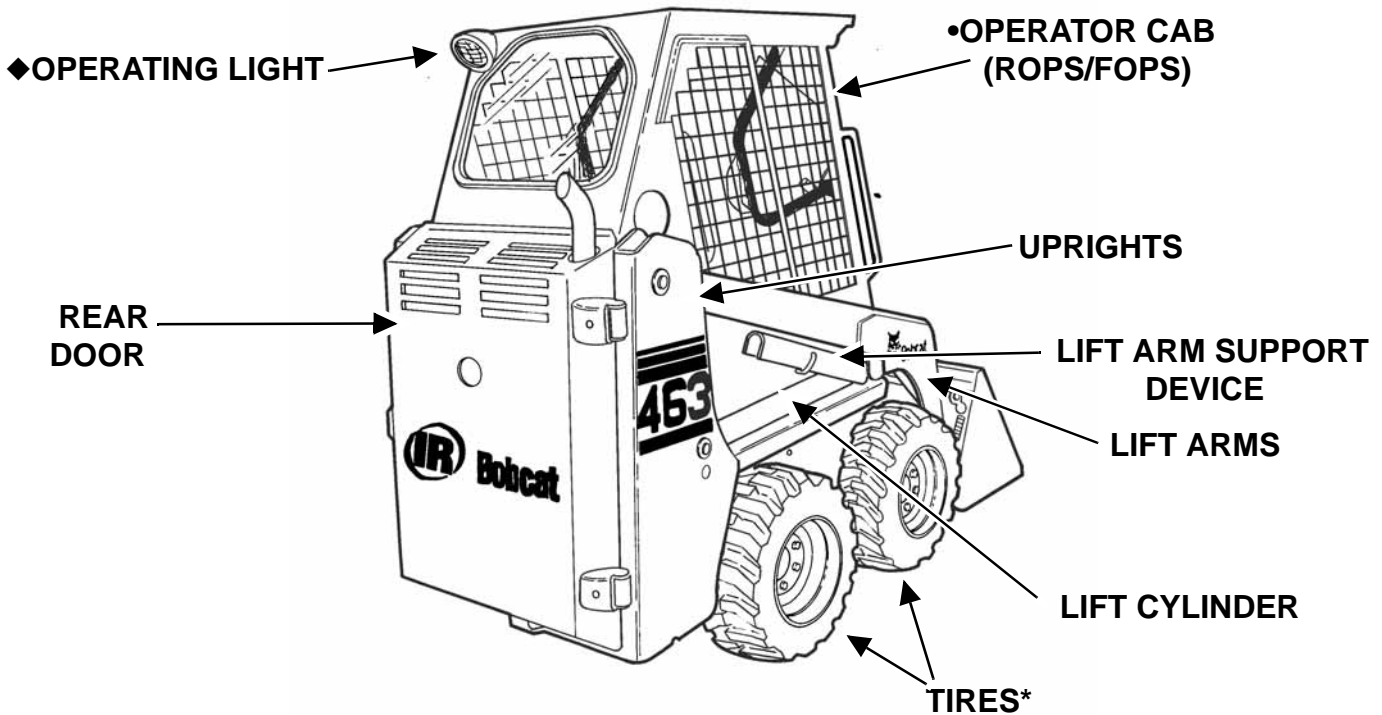

◆ FACTORY OPTION OR FIELD ACCESSORY (Not Standard Equipment)

\* TIRES - Flotation tires (Optional) are shown. Bobcats are base-equipped with standard tires.

† BUCKET - Several different buckets and other attachments are available for the Bobcat loader.

• ROPS, FOPS - Roll-Over Protective Structure, Falling Object Protective Structure, per SAE J1040 and ISO 3471, and Falling Object Protective Structure per SAE J1043 and ISO 3449, Level 1. The Bobcat loader is base-equipped with a standard operator cab as shown. Extra insulated cab is available as an option (Reduced noise level).

B-15915

## SAFETY AND MAINTENANCE

## SAFETY & MAINTENANCE

AIR CLEANER SERVICE .....	10-80-1
Replacing Filter Element .....	10-80-1
AUXILIARY CONTROL LOCKBOLT .....	10-140-1
Procedure .....	10-140-1
BOB-TACH .....	10-150-1
Inspection And Maintenance .....	10-150-1
ENGINE COOLING SYSTEM .....	10-90-1
Checking The Coolant Level .....	10-90-1
Cleaning The Cooling System .....	10-90-1
Replacing The Coolant .....	10-90-2
ENGINE LUBRICATION SYSTEM .....	10-110-1
Checking Engine Oil .....	10-110-1
Oil Chart .....	10-110-1
Replacing Oil And Filter .....	10-110-1
FINAL DRIVE TRANSMISSION (CHAINCASE) .....	10-130-1
Checking And Adding Oil .....	10-130-1
FUEL SYSTEM .....	10-100-1
Filling The Fuel Tank .....	10-100-1
Fuel Filter .....	10-100-3
Fuel Specification .....	10-100-1
Removing Air From The Fuel System .....	10-100-4
HYDRAULIC/HYDROSTATIC SYSTEM .....	10-120-1
Checking And Adding Fluid .....	10-120-1
Hydraulic/Hydrostatic Filter Replacement .....	10-120-2
Replacing The Hydraulic/Hydrostatic Fluid .....	10-120-2
LIFT ARM SUPPORT DEVICE .....	10-20-1
Disengaging The Lift Arm Support Device .....	10-20-2
Engaging The Lift Arm Support Device .....	10-20-1
LIFTING AND BLOCKING THE LOADER .....	10-10-1
Procedure .....	10-10-1
LUBRICATING THE LOADER .....	10-160-1
Procedure .....	10-160-1

Continued On Next Page

## SAFETY AND MAINTENANCE (CONT'D)

OPERATOR CAB .....	10-30-1
Description .....	10-30-1
Emergency Exit .....	10-30-3
Lowering The Operator Cab .....	10-30-2
Raising The Operator Cab .....	10-30-1
PIVOT PINS .....	10-190-1
REMOTE START SWITCH .....	10-60-1
Procedure .....	10-60-1
SEAT BAR RESTRAINT SYSTEM .....	10-200-1
Foot Pedal Clean Out .....	10-200-2
Seat Bar Inspection .....	10-200-1
Seat Bar Maintenance .....	10-200-1
SERVICE SCHEDULE .....	10-70-1
Chart .....	10-70-1
SPARK ARRESTOR MUFFLER .....	10-180-1
Cleaning Procedure .....	10-180-1
TIRE MAINTENANCE .....	10-170-1
Tire Inflation .....	10-170-1
Tire Rotation .....	10-170-1
Wheel Nuts .....	10-170-1
TOWING THE LOADER .....	10-50-1
Procedure .....	10-50-1
TRANSPORTING THE LOADER .....	10-40-1
Adjusting The Bumper .....	10-40-1
Procedure .....	10-40-1

## LIFTING AND BLOCKING THE LOADER

### **WARNING**

Instructions are necessary before operating or servicing machine. Read and understand the Operation & Maintenance Manual, Handbook and signs (decals) on machine. Follow warnings and instructions in the manuals when making repairs, adjustments or servicing. Check for correct function after adjustments, repairs or service. Untrained operators and failure to follow instructions can cause injury or death [Figure 10-10-1].

W-2003-0199

Figure 10-10-1

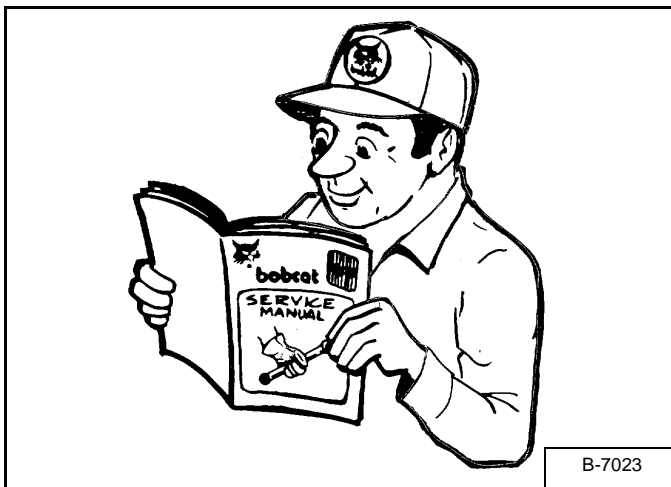

### Procedure

Always park the loader on a level surface.

### **WARNING**

Put jackstands under the front axles and rear corners of the frame before running the engine for service. Failure to use jackstands can allow the machine to fall or move and cause injury or death.

W-2017-0286

Figure 10-10-2

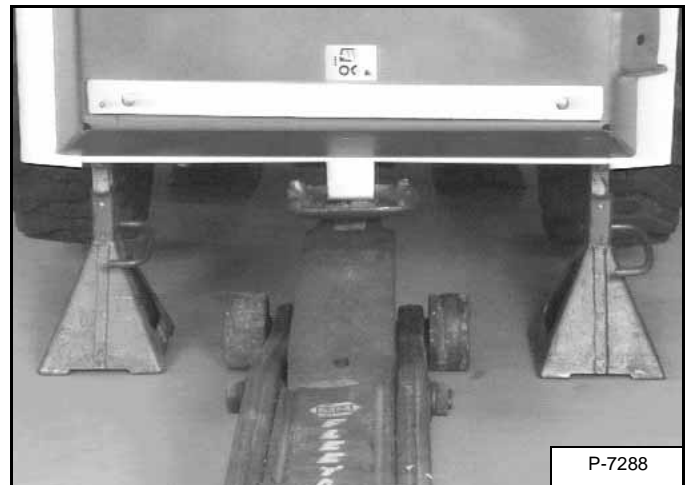

Put a floor jack under the rear of the loader [Figure 10-10-2].

Lift the rear of the loader and install jackstands [Figure 10-10-2].

Figure 10-10-3

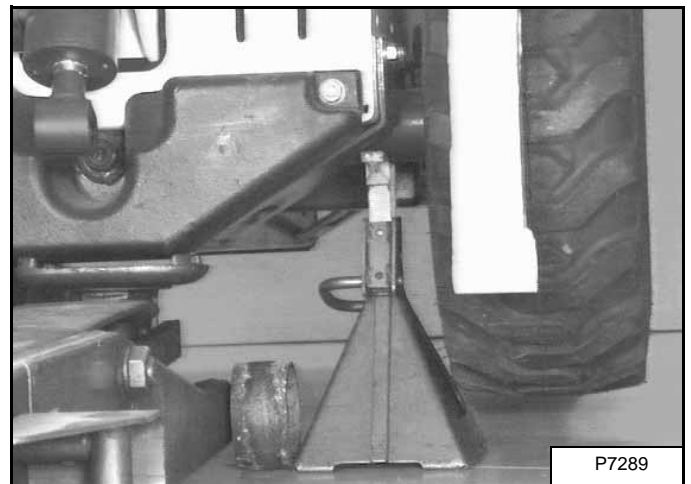

Put the floor jack under the front of the loader [Figure 10-10-3].

Lift the front of the loader and put jackstands under the loader frame.

**NOTE: Make sure the jackstands do not touch the tires.**

## LIFT ARM SUPPORT DEVICE

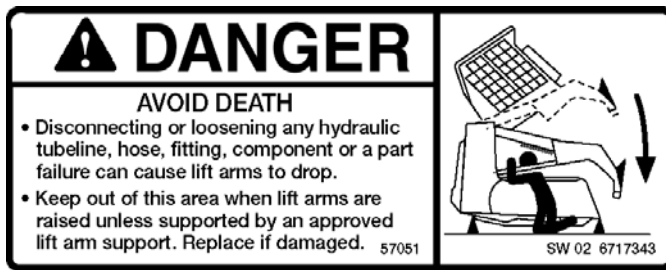

Never work on a machine with the lift arms up unless the lift arms are secured by an approved lift arm support device. Failure to use an approved lift arm support device can allow the lift arms or attachment to fall and cause injury or death.

W-2059-0598

### Engaging The Lift Arm Support Device

Figure 10-20-1

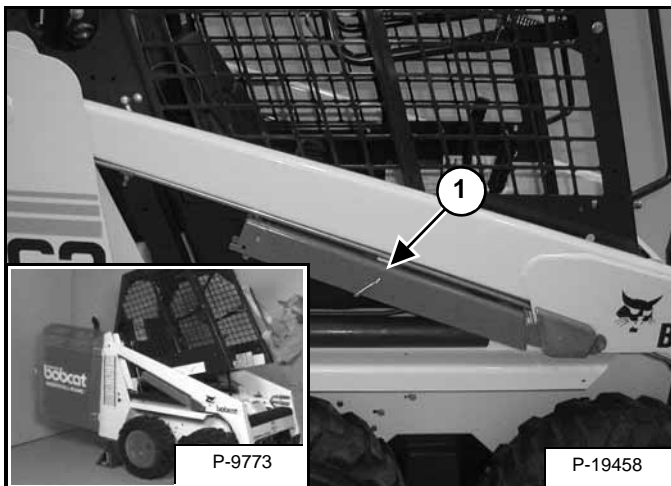

Put jackstands under the rear corners of the loader (Inset) [Figure 10-20-1].

Disconnect the spring from the lift arm support device retaining pin (Item 1) [Figure 10-20-1], hold the support device and remove the retaining pin.

Figure 10-20-2

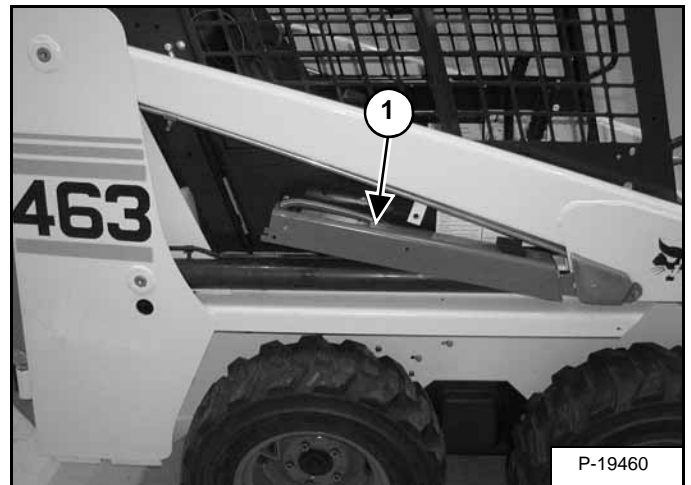

Lower the lift arm support device on top of the lift cylinder. Fasten the free end of the spring (Item 1) [Figure 10-20-2] to the lift arm support device so there will be no interference with the support device engagement.

With the operator in the seat, seat belt fastened and seat bar lowered, start the engine. Press the green *PRESS TO OPERATE* Button.

Figure 10-20-3

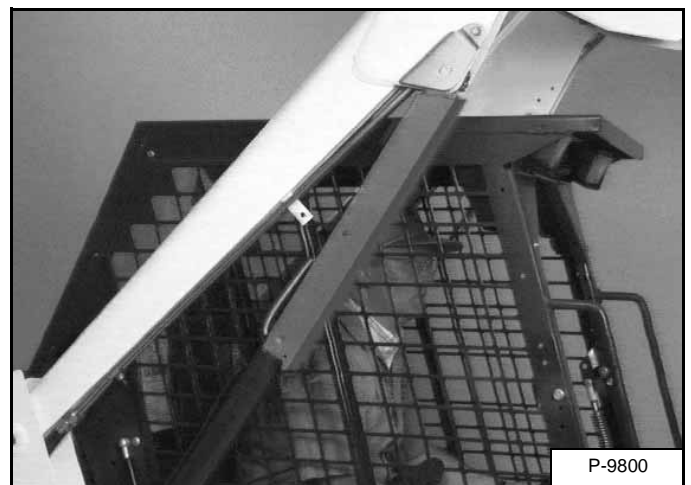

Raise the lift arms until the lift arm support device drops onto the lift cylinder (Item 1) [Figure 10-20-3].

Lower the lift arms slowly until the support device is held between the lift arm and the lift cylinder. Stop the engine. Raise the seat bar and move pedals until both pedals lock.

## LIFT ARM SUPPORT DEVICE (CONT'D)

### Engaging The Lift Arm Support Device (Cont'd)

Figure 10-20-4

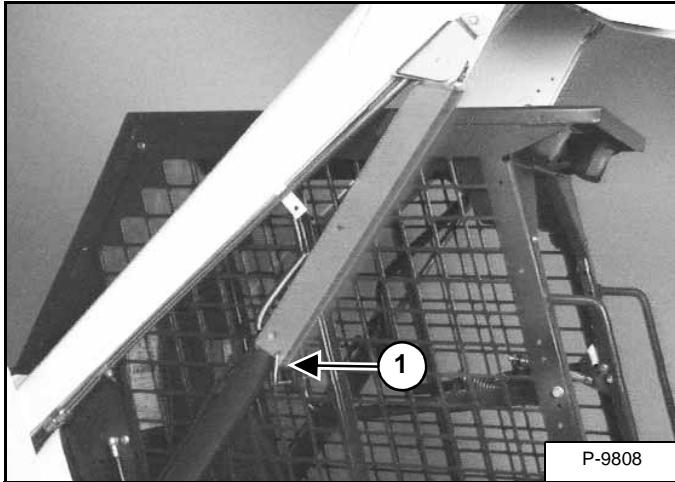

Install the retaining pin (Item 1) [Figure 10-20-4] into the rear of the lift arm support device below the cylinder rod.

## **WARNING**

Service lift arm support device if damaged or if parts are missing. Using a damaged lift arm support or with missing parts can cause lift arms to drop causing injury or death.

W-2271-1197

### Disengaging The Lift Arm Support Device

Figure 10-20-5

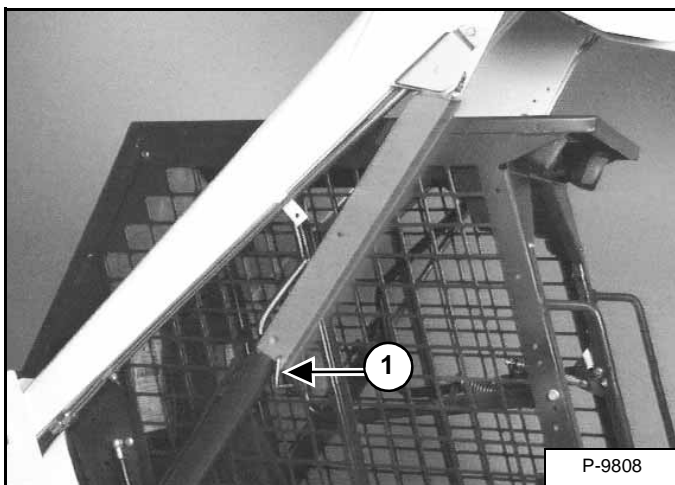

Remove the retaining pin (Item 1) [Figure 10-20-5] from the lift arm support device.

Figure 10-20-6

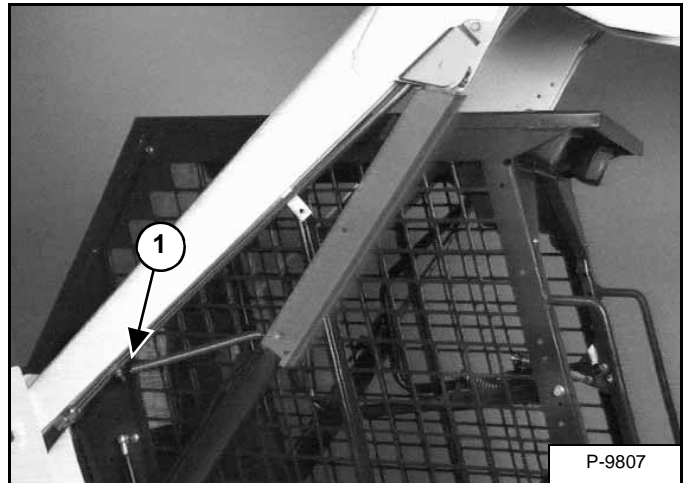

Connect the spring from the lift arm support device to the tubeline bracket (Item 1) [Figure 10-20-6] on the lift arms.

With the operator in the seat, seat belt fastened and seat bar lowered, start the engine. Press the green *PRESS TO OPERATE* Button.

Raise the lift arms a small amount and the spring will lift the support device off the lift cylinder rod. Lower the lift arms. Stop the engine.

Raise the seat bar and move pedals until both pedals lock.

Disconnect the spring from the bracket.

Figure 10-20-7



Raise the support device into storage position and insert pin through lift arm support device and bracket (Item 1) [Figure 10-20-7].

Connect spring to pin [Figure 10-20-7].

## OPERATOR CAB

### Description



**Before the cab or the lift arms are raised for service, jackstands must be put under the rear corners of the frame. Failure to use jackstands can allow the machine to tip backward causing injury or death.**

W-2014-0895

The Bobcat loader has an operator cab (ROPS and FOPS) as standard equipment to protect the operator from rollover and falling objects. Check with your dealer if the operator cab has been damaged. The seat belt must be worn for roll over protection.

*ROPS/FOPS* Roll Over Protective Structure per SAE J1040 and ISO 3471, and Falling Object Protective Structure per SAE J1043 and ISO 3449, Level 1.

*Level 1* - Protection from falling bricks, small concrete blocks and hand tools encountered in operations such as highway maintenance, landscaping, and other construction site services.

Check with your dealer if the operator cab has been changed.

**Figure 10-30-1**

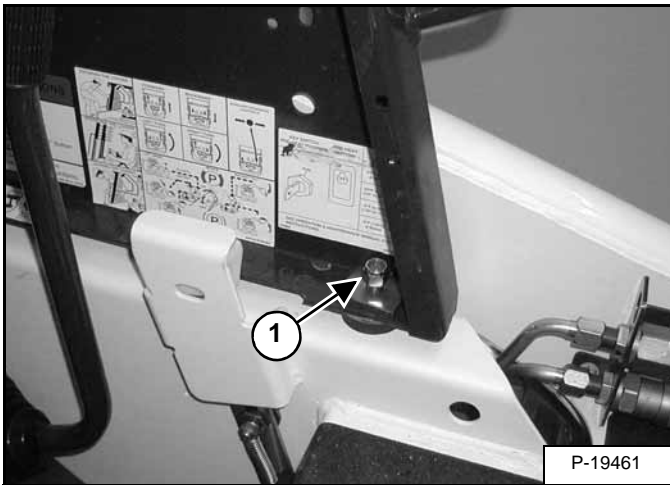

The operator cab fastening nuts (Item 1) [Figure 10-30-1] must be tightened to 40-50 ft.-lbs. (54-68 Nm) torque.

## Raising The Operator Cab

Stop the loader on a level surface. Put the lift arms all the way down.

Install jackstands under the rear of the loader frame.

Open the rear door. (See REAR DOOR on Page 50-70-1.)

If the lift arms must be up while raising the cab, install the lift arm support device. (See Engaging The Lift Arm Support Device on Page 10-20-1.)

Remove the two fasteners (Item 1) [Figure 10-30-1] at the front (both sides) of the operator cab.

**Figure 10-30-2**



Stand on the ground. Lift slowly until operator cab is all the way up [Figure 10-30-2].

The operator cab will lock in the raised position



**Never modify operator cab by welding, grinding, drilling holes or adding attachments unless instructed to do so by Bobcat. Changes to the cab can cause loss of operator protection from rollover and falling objects, and result in injury or death.**

W-2069-1299

## OPERATOR CAB (CONT'D)

### Lowering The Operator Cab

# WARNING

The cab must be held to prevent falling while hand is in access hole.

W-2205-0695

Figure 10-30-3

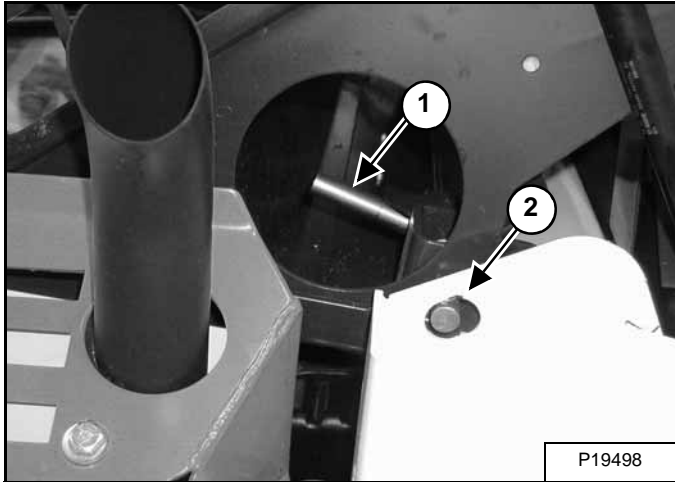
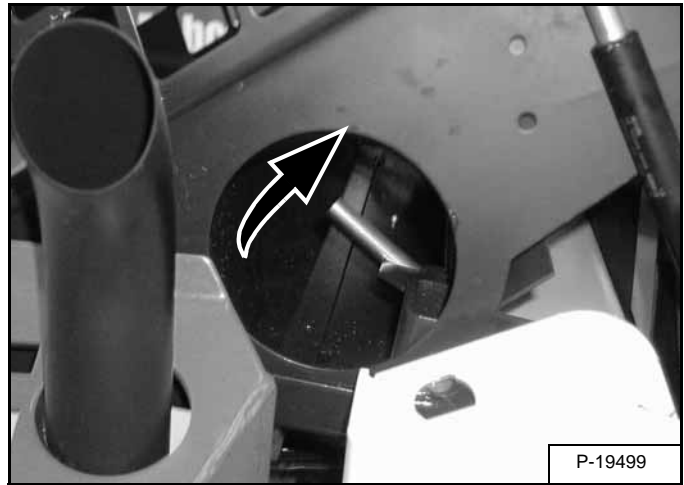

Figure 10-30-4



Hold the operator cab. Release the locking mechanism by pushing the lever (Item 1) [Figure 10-30-3] inward from the locked position and lifting the lever until it stays in the unlocked position [Figure 10-30-4].

The pin (Item 2) [Figure 10-30-3] must be retracted from the hole in the upright before lowering the operator cab.

**REMOVE YOUR HAND FROM THE HOLE BEFORE LOWERING THE OPERATOR CAB**

Stand on the ground and pull down on the operator cab.

Avoid slippery surfaces when lowering the cab.

**NOTE: Guide the operator cab over the fastening bolts to prevent thread damage.**

Figure 10-30-5

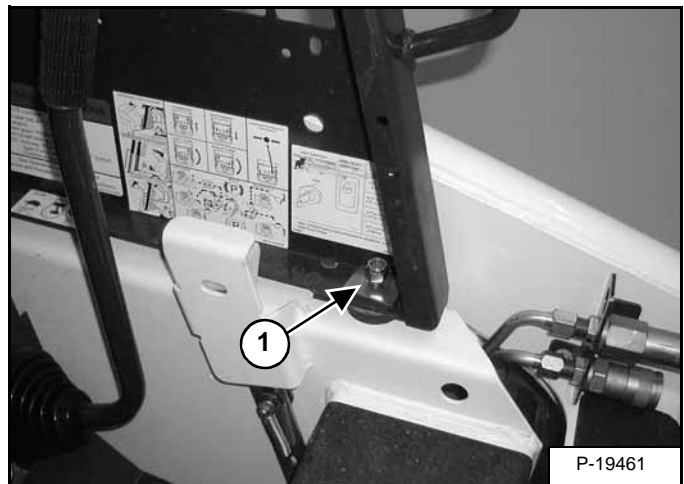

Install the cab washers and nuts. Tighten the nuts (Item 1) [Figure 10-30-5] (both sides) to 40-50 ft.-lbs. (54-68 Nm) torque.

## OPERATOR CAB (CONT'D)

### Emergency Exit

Figure 10-30-6

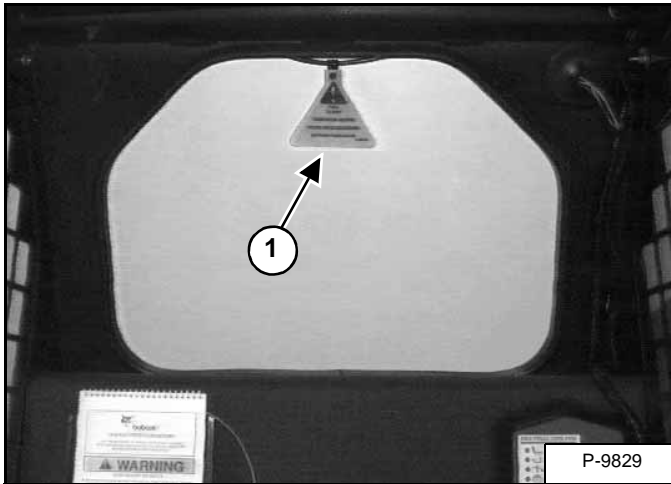

The front opening on the operator cab and rear window provide exits.

Pull on the tag (Item 1) **[Figure 10-30-6]** at the top of the rear window to remove the rubber cord.

Push the rear window out of the rear of the operator cab.

Figure 10-30-7



Exit through the rear of the cab **[Figure 10-30-7]**.

## TRANSPORTING THE LOADER

### Procedure



Adequately designed ramps of sufficient strength are needed to support the weight of the machine when loading onto a transport vehicle. Wood ramps can break and cause personal injury.

W-2058-0494

Figure 10-40-1

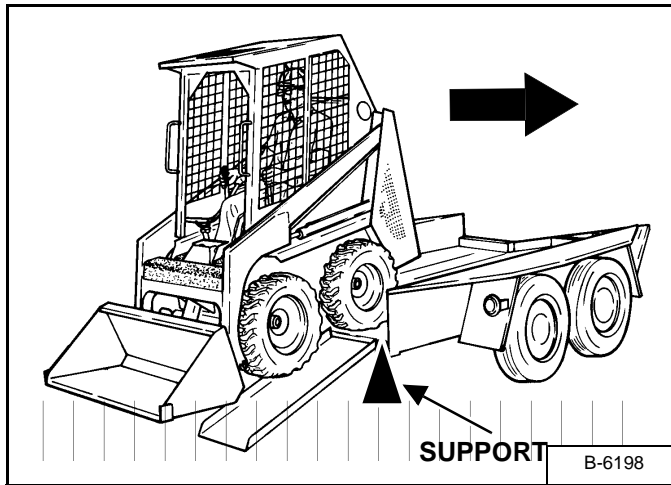

Be sure the transport and towing vehicles are of adequate size and capacity.

A loader with an empty bucket or no attachment must be loaded backward onto the transport vehicle [Figure 10-40-1].

The rear of the trailer must be locked or supported [Figure 10-40-1] when loading or unloading the loader to prevent the front end of the trailer from raising up.

## Adjusting The Bumper

Figure 10-40-2

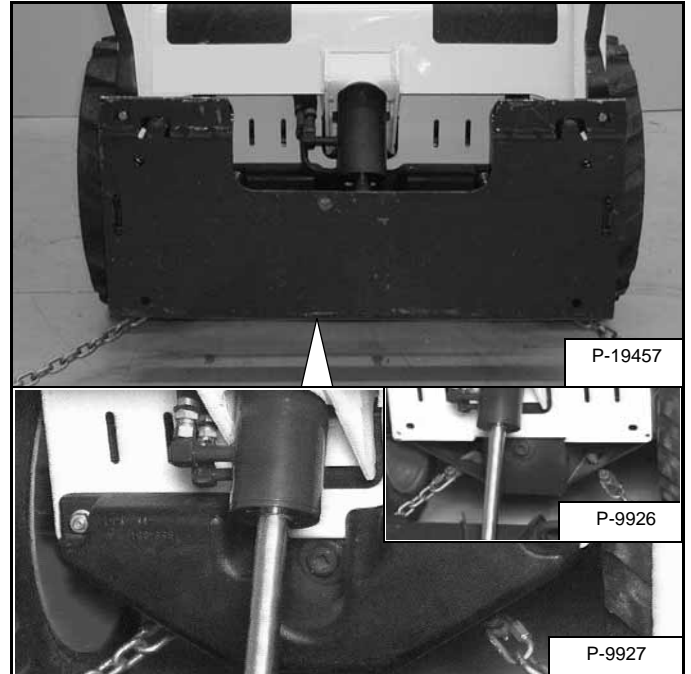

Use the following procedure to fasten the Bobcat loader to the transport vehicle to prevent the loader from moving during sudden stops or when going up or down slopes [Figure 10-40-2].

Fully lower any bucket or attachment. Stop the engine. Engage the parking brake.

Fasten chains at the front using the slots in the axle gussets [Figure 10-40-2]. The counterweight is removed (Inset) to show clarity. DO NOT operate the loader with counterweight removed.

Figure 10-40-3

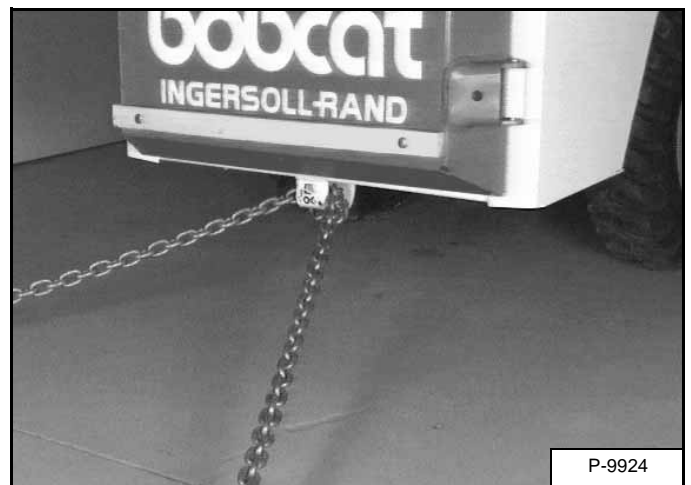

Fasten the rear of the loader as shown with a loop of chain through the tie down provided [Figure 10-40-3].

## TOWING THE LOADER

### Procedure

# IMPORTANT

Do not push or pull the machine at more than 2 MPH (3,2 km/h) or for a distance of more than 25 feet (7,6 meters) with the towing tool in place.

I-2017-0389

Be sure the transport and towing vehicles are of adequate size and capacity.

To prevent damage to the loader's hydrostatic system, a tow valve is available for towing the loader short distances at slow speeds. (Example: Moving the loader onto a transport vehicle.)

A tow valve is available from your dealer and must be installed before towing the loader.

Raise the operator cab. (See Raising The Operator Cab on Page 10-30-1.)

Clean the area around the hydrostatic pumps.

Figure 10-50-1

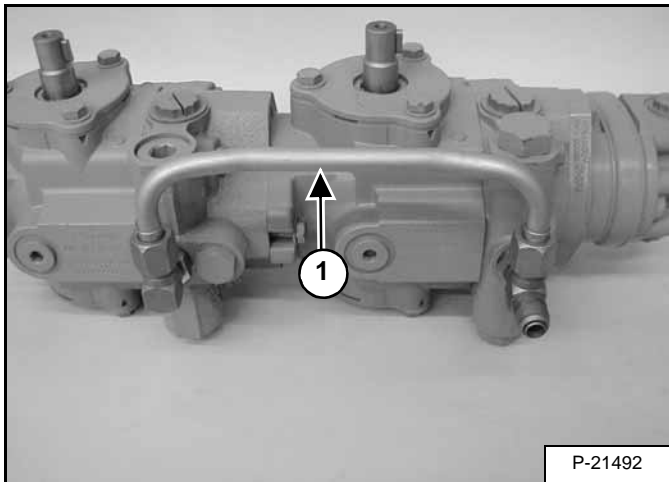

Remove the charge pressure tubeline and fittings (Item 1) [Figure 10-50-1] from the front side of the hydrostatic pumps.

Figure 10-50-2

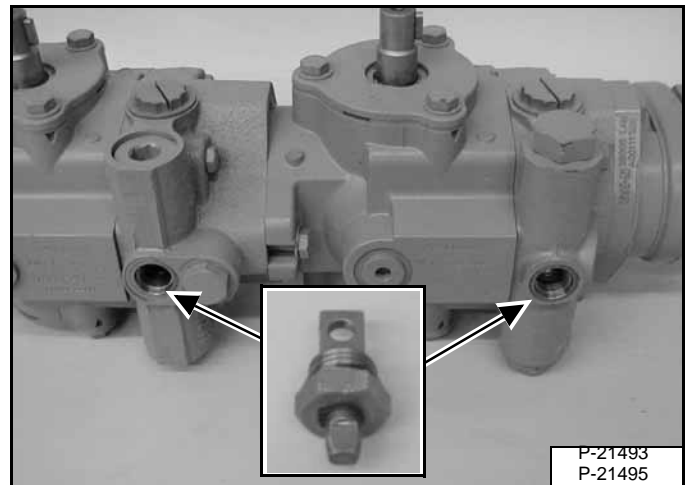

Install the tow valves in the fitting holes [Figure 10-50-2].

Figure 10-50-3

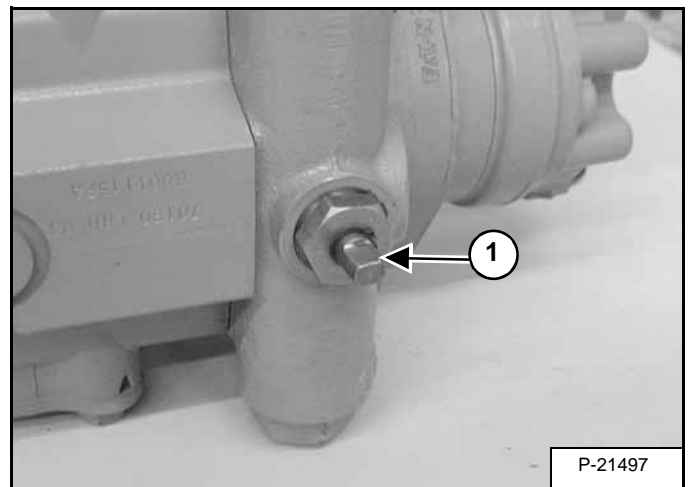

Tighten the jam nut (Item 1) [Figure 10-50-3] to 20-25 ft.-lbs. (27-34 Nm) torque while the tow valve flats are in the horizontal position.

## TOWING THE LOADER (CONT'D)

### Procedure (Cont'd)

Figure 10-50-4

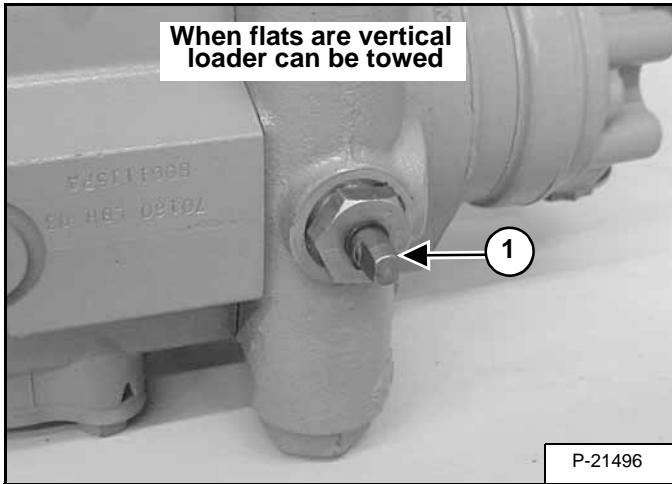

Turning the tow valves so the flats are vertical as shown (Item 1) [Figure 10-50-4] will release the relief valves and the check valves in the hydrostatic pumps and allow the loader to be moved.

The towing chain (or cable) must be rated at 1-1/2 times the weight of the loader. (See Machine Specifications on Page SPEC-10-1.)

Turn the key switch to ON and press the traction lock override button.

If the electrical system is not functioning, contact your Bobcat loader dealer. (Part of the brake system must be disassembled to move the loader.)

Remove the tow valves and install the fittings and charge tubelines before operating the loader.

## REMOTE START SWITCH

### Procedure

The tool listed will be needed to do the following procedure:

MEL1429-B- Remote Start Switch Kit

Kit Includes:

MEL1429-1 Adapter  
MEL1429- 2 Start Switch  
MEL1429-3 Adapter

The Remote Start Switch is required when the operator cab is in the raised position for service and the service technician needs to start the engine. The operator cab wire harness connectors must be separated from the engine wiring harness connector under the cab.

The remote start switch is required when the service technician is adjusting the steering linkage and checking the hydraulic/hydrostatic system.



**Put jackstands under the front axles and rear corners of the frame before running the engine for service. Failure to use jackstands can allow the machine to fall or move and cause injury or death.**

W-2017-0286



**Never work on a machine with the lift arms up unless the lift arms are secured by an approved lift arm support device. Failure to use an approved lift arm support device can allow the lift arms or attachment to fall and cause injury or death.**

W-2059-0598

Lift and block the loader. (See LIFTING AND BLOCKING THE LOADER on Page 10-10-1.)

Raise the lift arms and install the lift arm support device. (See Engaging The Lift Arm Support Device on Page 10-20-1.)

Raise the operator cab. (See Raising The Operator Cab on Page 10-30-1.)

Figure 10-60-1

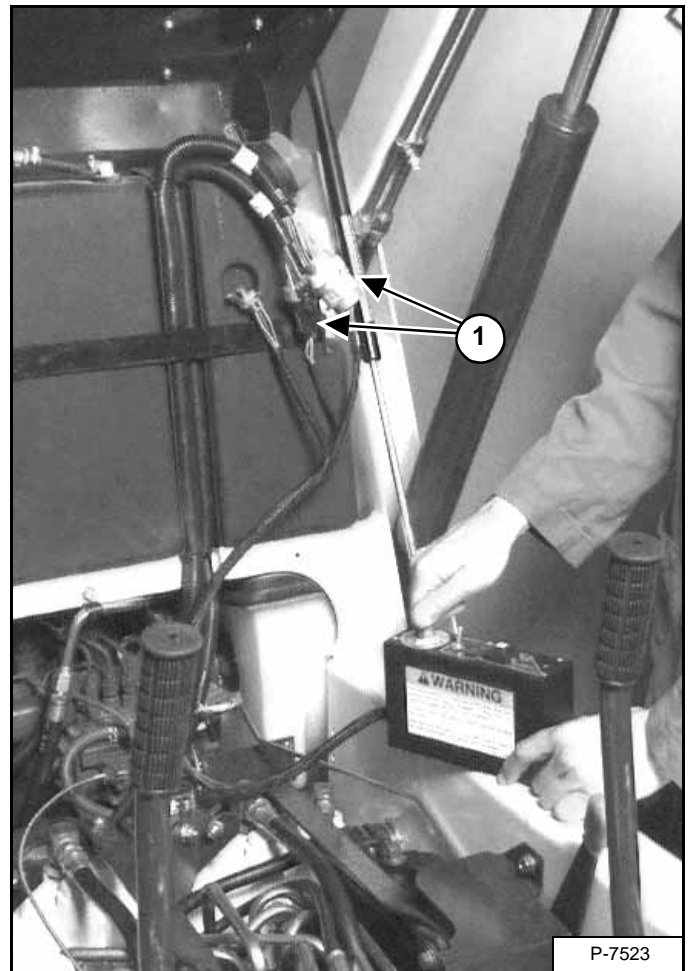

Connect the remote start switch to the connectors (Item 1) [Figure 10-60-1].

Replace the inner filter every third time the outer filter is replaced or as indicated by the Service Schedule.

## REMOTE START SWITCH (CONT'D)

### Procedure (Cont'd)

Figure 10-60-2

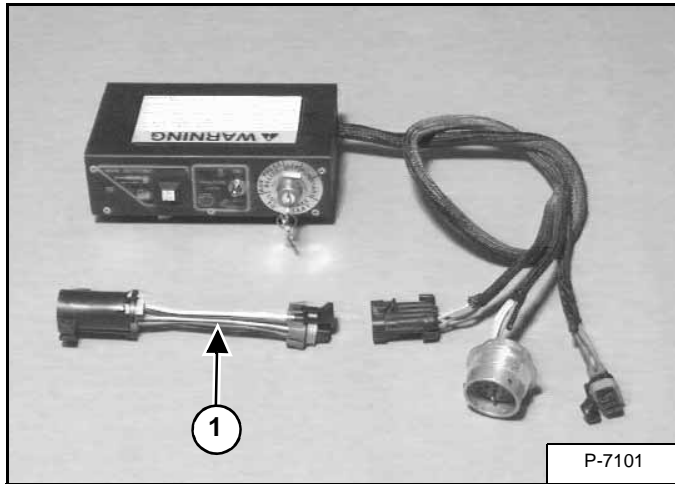

**NOTE:** On late model loaders, the connector on the BICS™ harness is a round 7-pin connector, NOT a rectangular 8-pin connector. Use the adapter (Item 1) [Figure 10-60-2] if your loader has a round 7-pin BICS harness connector.

Figure 10-60-3

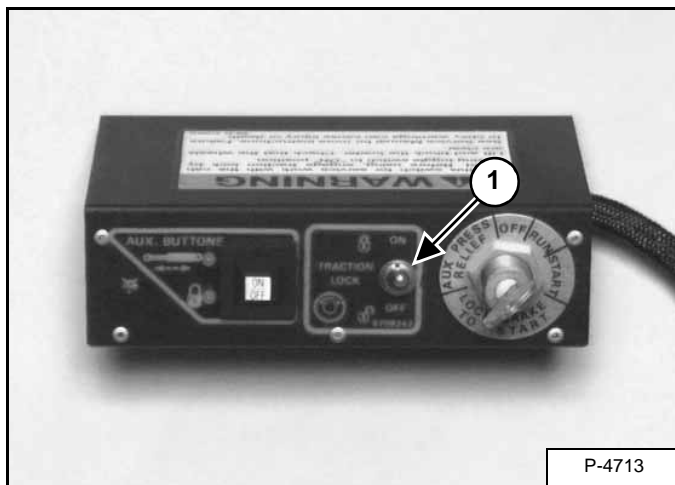

Put the traction lock override switch (Item 1) [Figure 10-60-3] in the ON position so the traction function is locked. The wheels are not able to turn.

Turn the key to the right and start the engine.

Figure 10-60-4

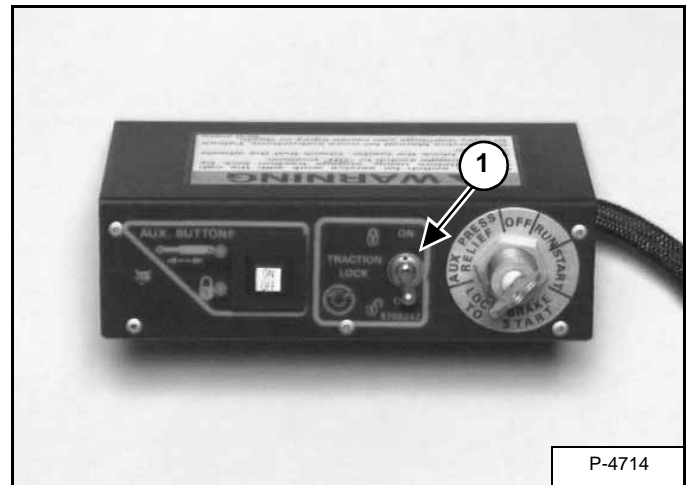

Move the traction lock override switch (Item 1) [Figure 10-60-4] to the OFF position so the traction function is unlocked. The wheels are now able to turn.



**Suggest:**

**If the above button click is invalid.**

**Please download this document**

**first, and then click the above link**

**to download the complete manual.**

**Thank you so much for reading**

## SERVICE SCHEDULE

### Chart

Maintenance work must be done at regular intervals. Failure to do so will result in excessive wear and early failures. The service schedule is a guide for correct maintenance of the Bobcat loader.

 <h1 style="margin: 0;">WARNING</h1>	<p><b>Instructions are necessary before operating or servicing machine. Read and understand the Operation &amp; Maintenance Manual and signs (decals) on machine. Follow warnings and instructions in the manuals when making repairs, adjustments or servicing. Check for correct function after adjustments, repairs or service. Untrained operators and failure to follow instructions can cause injury or death.</b></p>
W-2003-1285	

SERVICE SCHEDULE		HOURS					
ITEM	SERVICE REQUIRED	8-10	50	100	250	500	■1000
Engine Air Cleaner	Empty the dust cup & replace the filter as needed.						
Engine Oil	Check the engine oil level and add oil as needed.						
Engine Cooling System	Clean debris from oil cooler, radiator and grill. Check coolant level in recovery tank. Add coolant as needed.						
Tires	Check for damaged tires and correct air pressure.						
Indicators, Gauges, & Lights (Opt.)	Check for correct operation of all indicators, gauges & lights (Opt.).						
Seat Belt, Seat Bar	Check the condition of the seat belt. Check the seat bar & pedal interlocks for correct operation. Clean dirt and debris from moving parts.						
Safety Signs (Decals) and Safety Tread	Check for damaged sign (decals) and safety treads. Replace any signs or safety treads that are damaged or worn.						
Lift Arms and Bob-Tach Pivot Pins and Wedges	Lubricate with multi-purpose lithium based grease.						
Engine Fuel Filter	Remove the water from the filter.						
Hydraulic Fluid, Hoses and Tubelines	Check fluid level and add as needed. Check for damage and leaks. Repair or replace as needed.						
Bobcat Interlock Control System (BICS™)	Check BICS™ System Controller functions. Clean dirt, debris or objects from under or behind seat as required.						
Battery	Check cables, connections and electrolyte level. Add distilled water as needed.						
Control Pedals & Steering	Check for correct operation. Repair or adjust as needed.						
Bob-Tach	Check locking levers & wedges for condition & operation.						
Wheel Nuts	☐ Check for loose wheel nuts & tighten to 40-45 ft.-lbs. (54-61 Nm) torque.						
Parking Brake	Check operation.						
Alternator Belt	Check belt tension and adjust as needed.						
Engine Oil and Filter	Replace oil and filter. (See Oil Chart on Page 10-110-1.)						
Hydraulic Filter Element	Replace Filter Element.						
Spark Arrestor Muffler	Clean the spark chamber.						
Drive Belt	Clean the spark chamber.						
Steering Lever Pivots	Lubricate grease fittings and oil hole in the steering shaft.						
Engine Fuel Filter	Replace the filter element.						
Hydraulic Reservoir Breather	Replace the breather cap.						
Final Drive Trans (Chaincase)	Replace the fluid.						
Hydraulic/Hydrostatic Reservoir	•Replace the fluid.						

☐ Check wheel nut torque every 8 hours for the first 24 hours.

• Also replace hydraulic/hydrostatic filter element when the transmission warning light stays on for five minutes after the hydraulic fluid is at operating temperature.

■ Or every 12 months.

**<https://www.ebooklibonline.com>**

Hello dear friend!

Thank you very much for reading.

Enter the link into your browser.

The full manual is available for immediate download.

**<https://www.ebooklibonline.com>**