



Bobcat®

**331
331E
334**

Service Manual

S/N 232511001 & Above
S/N 232711001 & Above
S/N 232611001 & Above
(D Series)

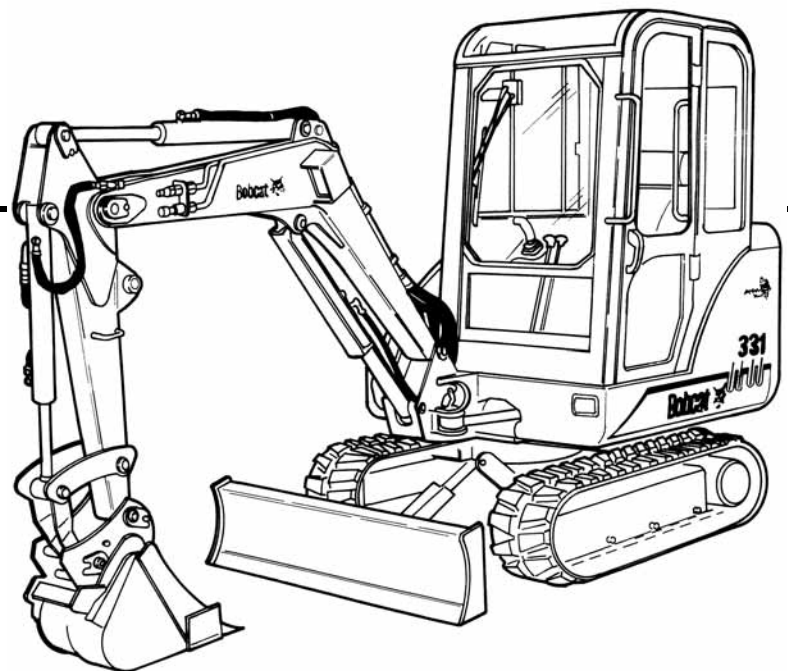

MAINTENANCE SAFETY



WARNING

Instructions are necessary before operating or servicing machine. Read and understand the Operation & Maintenance Manual, Operator's Handbook and signs (decals) on machine. Follow warnings and instructions in the manuals when making repairs, adjustments or servicing. Check for correct function after adjustments, repairs or service. Untrained operators and failure to follow instructions can cause injury or death.

W-2003-0903



Safety Alert Symbol: This symbol with a warning statement, means: "Warning, be alert! Your safety is involved!" Carefully read the message that follows.

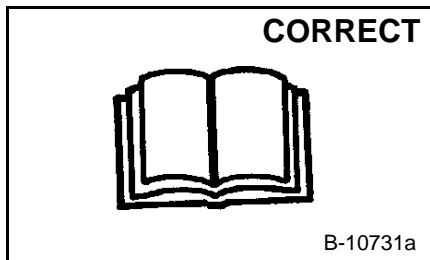

B-10731a

- ⚠ Never service the Bobcat Hydraulic Excavator without instructions.

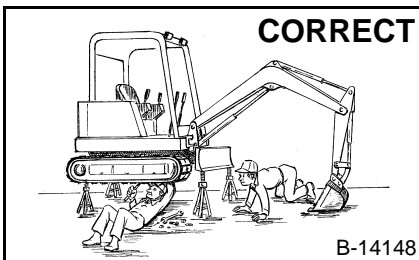

B-14148

- ⚠ Use the correct procedure to lift and support the excavator.
- ⚠ Always lift the blade fully before installing jackstands.

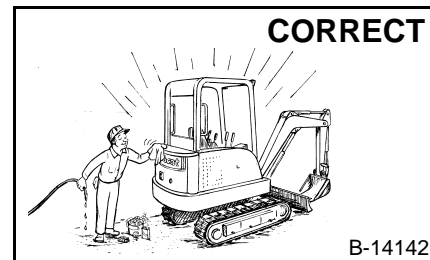

B-14142

- ⚠ Cleaning and maintenance are required daily.

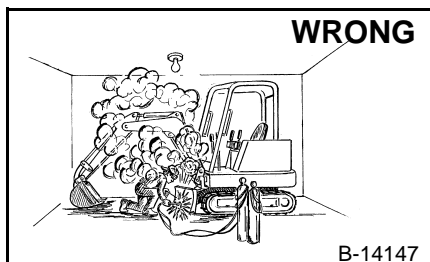

B-14147

- ⚠ Have good ventilation when welding or grinding painted parts.
- ⚠ Wear dust mask when grinding painted parts. Toxic dust and gas can be produced.



B-14141

- ⚠ Vent exhaust to outside when engine must be run for service.
- ⚠ Exhaust system must be tightly sealed. Exhaust Fumes can kill without warning.

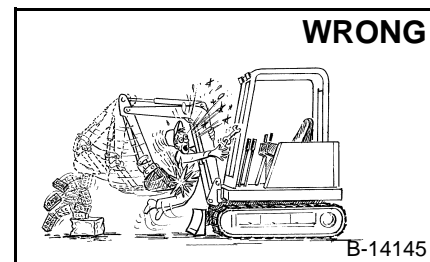

B-14145

- ⚠ Always lower the bucket and blade to the ground before doing any maintenance.
- ⚠ Never modify equipment or add attachments not approved by Bobcat Company.

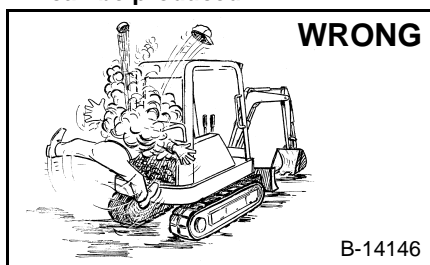

B-14146

- ⚠ Stop, cool and clean engine of flammable materials before checking fluids.
- ⚠ Never service or adjust machine with the engine running unless instructed to do so in the manual.
- ⚠ Avoid contact with leaking hydraulic fluid or diesel fuel under pressure. It can penetrate the skin or eyes.
- ⚠ Never fill fuel tank with engine running, while smoking or when near open flame.

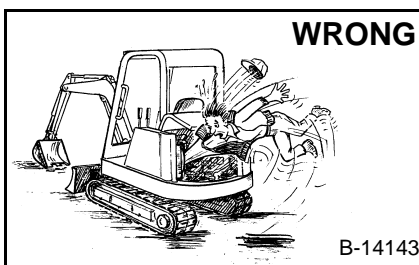

B-14143

- ⚠ Keep body, jewelry and clothing away from moving parts, electrical contact, hot parts and exhaust.
- ⚠ Wear eye protection to guard from battery acid, compressed springs, fluids under pressure and flying debris when engines are running or tools are used. Use eye protection approved for type of welding.
- ⚠ Keep rear door closed except for service. Close and latch door before operating the excavator.

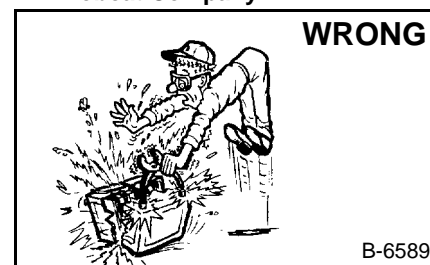

B-6589

- ⚠ Lead-acid batteries produce flammable and explosive gases.
- ⚠ Keep arcs, sparks, flames and lighted tobacco away from batteries.
- ⚠ Batteries contain acid which burns eyes or skin on contact. Wear protective clothing. If acid contacts body, flush well with water. For eye contact flush well and get immediate medical attention.

Maintenance procedures which are given in the Operation & Maintenance Manual can be performed by the owner/operator without any specific technical training. Maintenance procedures which are **not** in the Operation & Maintenance Manual must be performed **ONLY BY QUALIFIED BOBCAT SERVICE PERSONNEL**. Always use genuine Bobcat replacement parts. The Service Safety Training Course is available from your Bobcat dealer.

ALPHABETICAL INDEX

AIR CLEANER	60-01	HYDRAULIC PUMP	20-01
AIR CLEANER SERVICE	10-01	HYDRAULIC RESERVOIR	20-01
ALTERNATOR	50-01	HYDRAULIC SYSTEM	10-01
ARM	40-01	HYDRAULIC SYSTEM INFORMATION	20-01
ARM CYLINDER	20-01		
		LEFT CONTROL LEVER (JOYSTICK)	
BATTERY	50-01	(S/N 232512782 & Below, 232711433 & Below	
BLADE	30-01	and 232612157 & Below)	20-01
BLADE CONTROL	40-01	LEFT CONTROL LEVER (JOYSTICK)	
BLADE CYLINDER	20-01	(S/N 232512783 & Above, 232711434 & Above	
BOOM	40-01	and 232612158 & Above)	20-01
BOOM CYLINDER	20-01	LEFT CONSOLE	40-01
BOOM OFFSET CYLINDER	20-01	LIFTING AND BLOCKING THE EXCAVATOR	10-01
BUCKET	40-01	LIFTING THE EXCAVATOR	10-01
BUCKET CYLINDER	20-01	LIGHTS	50-01
BUILD UP VALVE	20-01	LUBRICATING THE EXCAVATOR	10-01
CAB	40-01	MAIN RELIEF VALVES	20-01
CASE DRAIN FILTER	20-01	MANIFOLD ASSEMBLY	
CLAMP	40-01	(S/N 232512782 & Below, 232711433 & Below	
CONVERSIONS	SPEC-01	and 232612157 & Below)	20-01
CONTROL LINKAGE ASSEMBLY	40-01	MANIFOLD ASSEMBLY	
CONTROL PATTERN SELECTOR VALVE	20-01	(S/N 232512783 & Above, 232711434 & Above	
CROSS PORT RELIEF VALVE	20-01	and 232612158 & Above)	20-01
		MANIFOLD ASSEMBLY/ACCUMULATOR	
DIAGNOSTICS SERVICE CODES	50-01	(S/N 232512782 & Below, 232711433 & Below	
DIRECT TO TANK VALVE	20-01	and 232612157 & Below)	20-01
		MANIFOLD ASSEMBLY/ACCUMULATOR	
ELECTRICAL SYSTEM INFORMATION	50-01	(S/N 232512783 & Above, 232711434 & Above	
ENGINE	60-01	and 232612158 & Above)	20-01
ENGINE COMPONENTS AND TESTING	60-01	MICROSWITCH	50-01
ENGINE COOLING SYSTEM	10-01	MUFFLER	60-01
ENGINE FLYWHEEL	60-01		
ENGINE LUBRICATION SYSTEM	10-01	OIL COOLER	20-01
ENGINE SPECIFICATIONS	SPEC-01	OPERATOR CAB (ROPS/TOPS) (If Equipped)	10-01
ENGINE SPEED CONTROL	40-01		
EXTENDIBLE ARM CYLINDER	20-01	PORT RELIEF VALVES	20-01
		PRESSURE REDUCING VALVE	20-01
FLOORMAT AND FLOOR PANELS	40-01	PRESSURE RELIEF VALVE	70-01
FUEL, COOLANT AND LUBRICANTS	SPEC-01	PRESSURE SWITCH	70-01
FUEL LEVEL SENDER	50-01		
FUEL SYSTEM	10-01	RADIATOR	60-01
FUEL TANK	40-01	RECEIVER/DRIER	60-01
		RECONDITIONING THE ENGINE	60-01
HEATER AIR FILTERS (With Cab Option Only)	10-01	REGULAR MAINTENANCE	70-01
HORN	40-01	RIGHT CONTROL LEVER (JOYSTICK)	
HYDRAULIC CONNECTION SPECS	SPEC-01	(S/N 232512782 & Below, 232711433 & Below	
HYDRAULIC CONTROL VALVE		and 232612157 & Below)	20-01
(S/N 232512782 & Below, 232711433 & Below		RIGHT CONTROL LEVER (JOYSTICK)	
and 232612157 & Below)	20-01	(S/N 232512783 & Above, 232711434 & Above	
HYDRAULIC CONTROL VALVE		and 232612158 & Above)	20-01
(S/N 232512783 & Above, 232711434 & Above		RIGHT CONSOLE	40-01
and 232612158 & Above)	20-01	RIGHT PEDAL AND LINKAGE	40-01
HYDRAULIC EXCAVATOR SPECS	SPEC-01	RIGHT SIDE COVER	40-01
HYDRAULIC FLUID SPECIFICATIONS	SPEC-01	ROPS CANOPY	40-01
HYDRAULIC FILTER	20-01		

<https://www.ebooklibonline.com>

Hello dear friend!

Thank you very much for reading.

Enter the link into your browser.

The full manual is available for immediate download.

<https://www.ebooklibonline.com>

SAFETY	70-01
SEAT AND MOUNT	40-01
SERVICE SCHEDULE	10-01
SPARK ARRESTOR MUFFLER	10-01
STARTER	50-01
SWING CIRCLE GEAR	30-01
SWING FRAME	40-01
SWING LOCK.....	10-01
SWING MOTOR	20-01
SWING MOTOR DRIVE CARRIER.....	20-
SWIVEL JOINT	20-01
SYSTEM CHARGING AND RECLAMATION	40-01
SYSTEM TROUBLESHOOTING CHART.....	70-01
TAILGATE	10-01
TEMPERATURE/PRESSURE	40-01
THERMOSTAT	70-01
TORQUE SPECIFICATIONS	SPEC-01
TRACKS	30-01
TRACK DAMAGE IDENTIFICATION.....	30-01
TRACK FRAME	30-01
TRACK IDLER	30-01
TRACK ROLLER.....	30-
TRANSPORTING THE EXCAVATOR.....	10-01
TRAVEL CONTROLS	40-01
TRAVEL MOTOR.....	10-01, 20-01
TROUBLESHOOTING.....	60-01
TWO SPEED SWITCH	50-01
UPPERSTRUCTURE	40-01

CONTENTS

SAFETY INSTRUCTIONS	V
FOREWORD.....	III
SERIAL NUMBER LOCATIONS	IX
DELIVERY REPORT.....	IX
BOBCAT EXCAVATOR IDENTIFICATION	X
SAFETY AND MAINTENANCE.....	10-01
HYDRAULIC SYSTEM	20-01
UNDERCARRIAGE.....	30-01
UPPERSTRUCTURE & SWING SECTION	40-01
ELECTRICAL SYSTEM AND ANALYSIS	50-01
ENGINE SERVICE	60-01
HEATING, VENTILATION, AIR CONDITIONING	70-01
SPECIFICATIONS.....	SPEC-01

**SAFETY AND
MAINTENANCE**

**HYDRAULIC
SYSTEM**

UNDERCARRIAGE

**UPPERSTRUCTURE
& SWING
SECTION**

**ELECTRICAL
SYSTEM AND
ANALYSIS**

**ENGINE
SERVICE**

**HEATING,
VENTILATION,
AIR CONDITIONING**

SPECIFICATIONS

FOREWORD

This manual is for the Bobcat Hydraulic excavator mechanic. It provides necessary servicing and adjustment procedures for the hydraulic excavator and its component parts and systems. Refer to the Operation & Maintenance Manual for operating instructions, starting procedure, daily checks, etc.

A general inspection of the following items must be made after the hydraulic excavator has had service or repair:

1. Check lift arm support device, replace if damaged. (Stored Position)

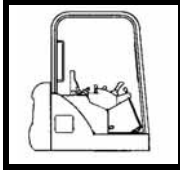

2. Check that ROPS mounting hardware is tightened and is Bobcat approved.

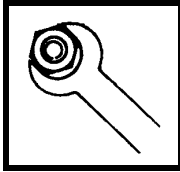

3. The seat belt must be correctly installed, functional and in good condition.

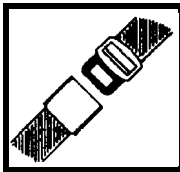

4. Inspect for loose or broken parts or connections.

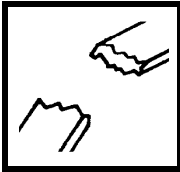

5. Machine signs must be legible and in the correct location.



6. Steering levers, control levers and foot pedals must return to neutral. Check that foot pedals lock and control lever locks are in working order.

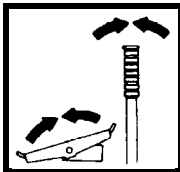

7. Inspect the air cleaner for damage or leaks. Check the condition of the element.

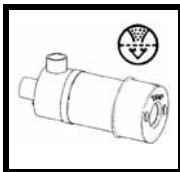

8. Check the electrical charging system.

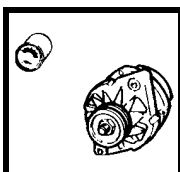

9. Safety treads must be in good condition.

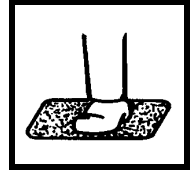

10. Check for correct function of indicator lamps (Optional on some models).

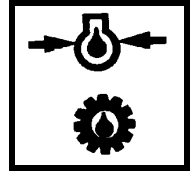

11. Check hydraulic fluid level, engine oil level and fuel supply.

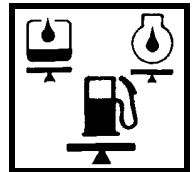

12. Inspect for fuel, oil or hydraulic fluid leaks.

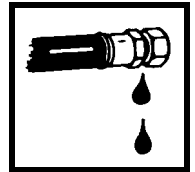

13. Lubricate the excavator.

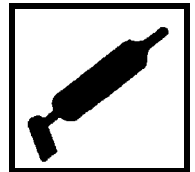

14. Check the condition of the battery and cables.

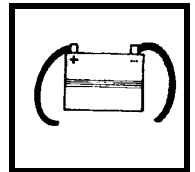

Recommend to the owner that all necessary corrections be made before the machine is returned to service.

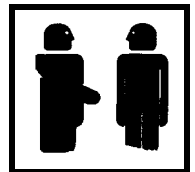

SAFETY INSTRUCTIONS



Safety Alert Symbol

This symbol with a warning statement means: "Warning, be alert! Your safety is involved!" Carefully read the message that follows.



WARNING

Instructions are necessary before operating or servicing machine. Read and understand the Operation & Maintenance Manual, Operator's Handbook and signs (decals) on machine. Follow warnings and instructions in the manuals when making repairs, adjustments or servicing. Check for correct function after adjustments, repairs or service. Untrained operators and failure to follow instructions can cause injury or death.

W-2003-0903



WARNING

Warnings on the machine and in the manuals are for your safety. Failure to obey warnings can cause injury or death.

W-2044-1285

IMPORTANT

This notice identifies procedures which must be followed to avoid damage to the machine.

I-2019-0284

The following publications provide information on the safe use and maintenance of the Bobcat machine and attachments:

- The Delivery Report is used to assure that complete instructions have been given to the new owner and that the machine is in safe operating condition.
- The Operation & Maintenance Manual delivered with the machine or attachment contains operating information as well as routine maintenance and service procedures. It is a part of the machine and can be stored in a container provided on the machine. Replacement Operation & Maintenance Manuals can be ordered from your Bobcat dealer.
- Machine signs (decals) instruct on the safe operation and care of your Bobcat machine or attachment. The signs and their locations are shown in the Operation & Maintenance Manual. Replacement signs are available from your Bobcat dealer.
- An Operator's Handbook fastened to the operator cab. It's brief instructions are convenient to the operator. The handbook is available from your dealer in an English edition or one of many other languages. See your Bobcat dealer for more information on translated versions.
- The AEM Safety Manual delivered with the machine gives general safety information.
- The Service Manual and Parts Manual are available from your dealer for use by mechanics to do shop-type service and repair work.
- The Compact Excavator Operator Training Course is available through your local dealer or at www.training.bobcat.com or www.bobcat.com. This course is intended to provide rules and practices of correct operation of the Bobcat Excavator. The course is available in English and Spanish versions.
- Service Safety Training Courses are available from your Bobcat dealer or at www.training.bobcat.com or www.bobcat.com. They provide information for safe and correct service procedures.
- The Bobcat Compact Excavator Safety Video is available from your Bobcat dealer or at www.training.bobcat.com or www.bobcat.com.

SI EXC-0206 SM

SAFETY INSTRUCTIONS (CONT'D)

Fire Prevention

The machine and attachments have components that are at high temperature under normal operating conditions. The primary source of high temperatures is the engine and exhaust system. The electrical system, if damaged or incorrectly maintained, can be a source of arcs or sparks.

Flammable debris (leaves, straw, etc.) must be removed regularly. If flammable debris is allowed to accumulate, it will increase fire hazard. Clean often to avoid this accumulation. Flammable debris in the engine compartment is a potential hazard.

The spark arrestor muffler is designed to control the emission of hot particles from the engine and exhaust system, but the muffler and the exhaust gases are still hot.

- Do not use the machine where exhaust, arcs, sparks or hot components can contact flammable material, explosive dust or gases.
- The operator cab, engine compartment, and engine cooling system must be inspected every day and cleaned if necessary to prevent fire hazard and overheating.
- Check all electrical wiring and connections for damage. Keep the battery terminals clean and tight. Repair or replace any damaged part.
- Check fuel and hydraulic tubes, hoses and fittings for damage and leakage. Never use open flame or bare skin to check for leaks. Tighten or replace any parts that show leakage. Always clean fluid spills. Do not use gasoline or diesel fuel for cleaning parts. Use commercial nonflammable solvents.
- Do not use ether or starting fluids on any engine which has glow plugs. These starting aids can cause explosion and injure you or bystanders.
- Always clean the machine, disconnect the battery, and disconnect the wiring from the controllers before welding. Cover rubber hoses, battery and all other flammable parts. Keep a fire extinguisher near the machine when welding. Have good ventilation when grinding or welding painted parts. Wear a dust mask when grinding painted parts. Toxic dust or gas can be produced.
- Stop the engine and let it cool before adding fuel. **NO SMOKING!**

- Use the procedure in the Operation & Maintenance Manual for connecting the battery and for jump starting.
- Use the procedure in the Operation & Maintenance Manual for cleaning the spark arrestor muffler (if equipped).

Figure 1

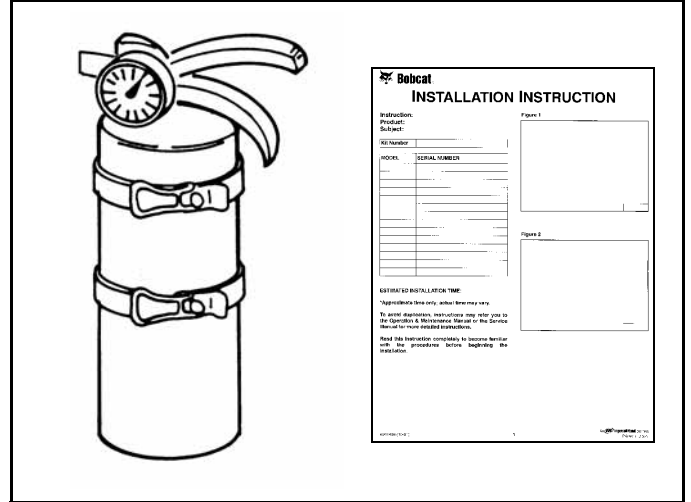

- Know where fire extinguishers and first aid kits are located and how to use them. Fire extinguishers are available from your Bobcat dealer [Figure 1].

SERIAL NUMBER LOCATIONS

Always use the FULL serial number (including the first four digits) when requesting service or when ordering parts. Early or later models (identification made by serial number) may use different parts, or it may be necessary to use a different procedure in doing a specific service operation.

Bobcat Excavator Serial Number

Figure 1

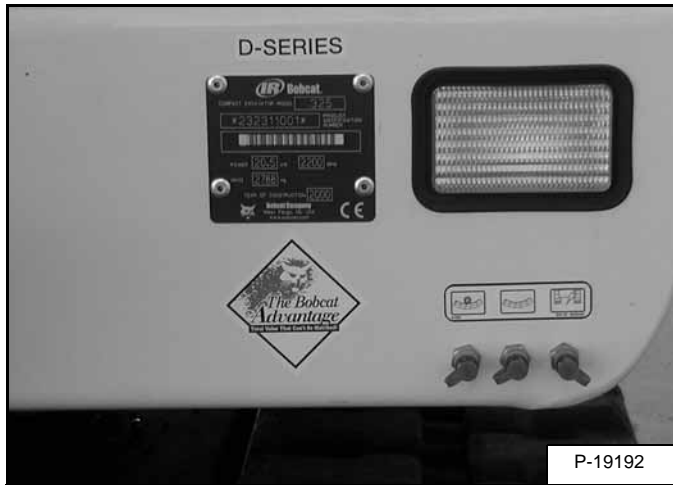

The Bobcat Excavator serial number is on the frame of the machine in the location shown [Figure 1].

Engine Serial Number

Figure 2

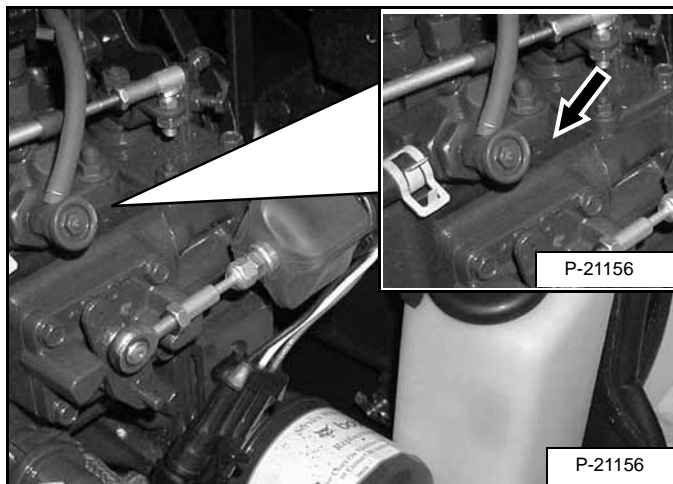

The engine serial number is located on the engine in the location shown [Figure 2].

DELIVERY REPORT

Figure 3

A diagram of a 'DELIVERY REPORT' form. The form is divided into several sections. At the top right is a section titled 'DELIVERY REPORT' with several lines for text. Below this is a section titled 'WARNING' with several lines for text. The rest of the form consists of multiple lines for text, likely for the dealer and owner/operator to fill out. A white box with the text 'B-16315' is located in the bottom right corner of the form.

The Delivery Report items must be explained to the owner/operator by the dealer. The dealer is to fill out the form and the owner/operator signs the form to indicate his understanding [Figure 3].

BOBCAT EXCAVATOR IDENTIFICATION

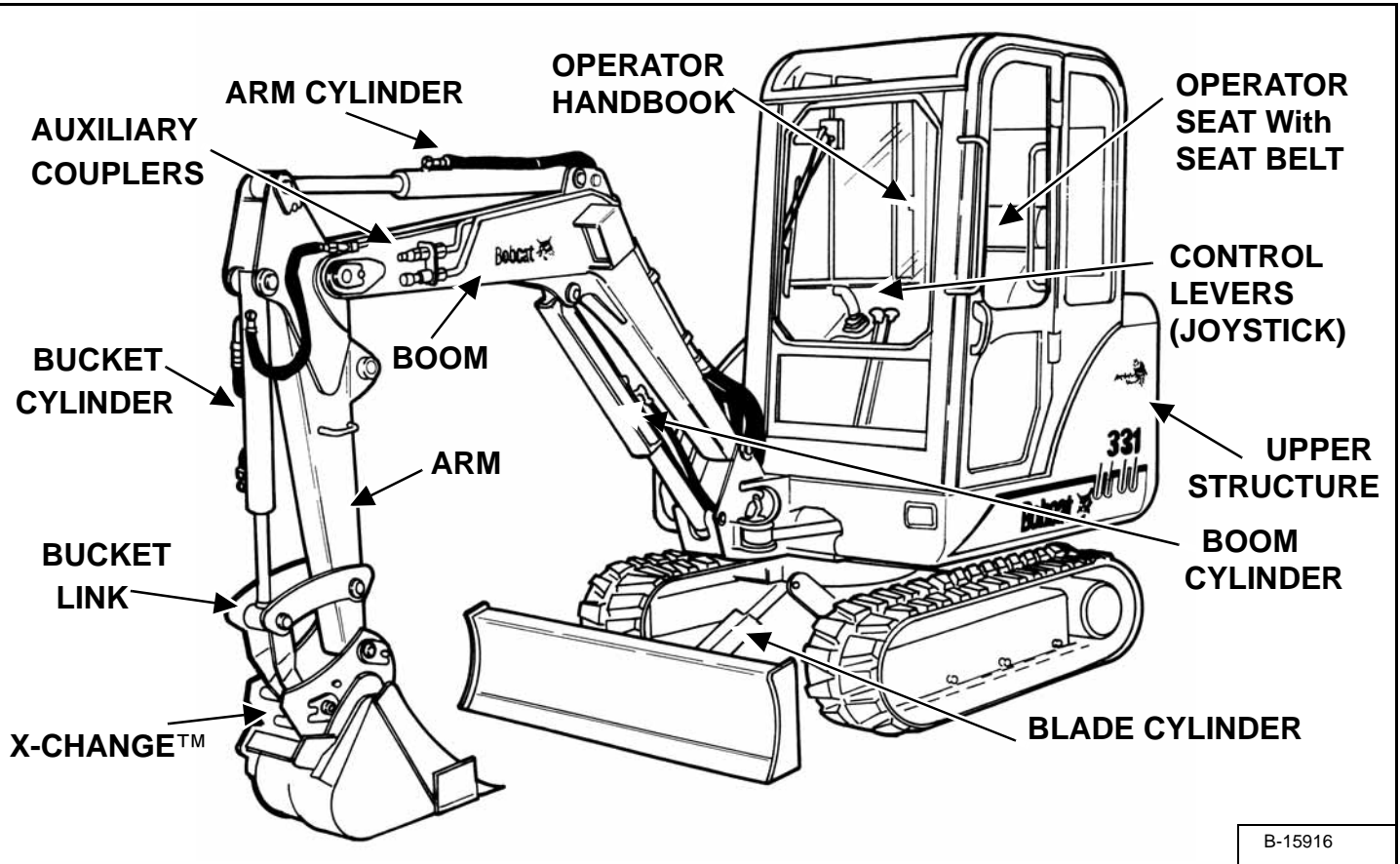

B-15916

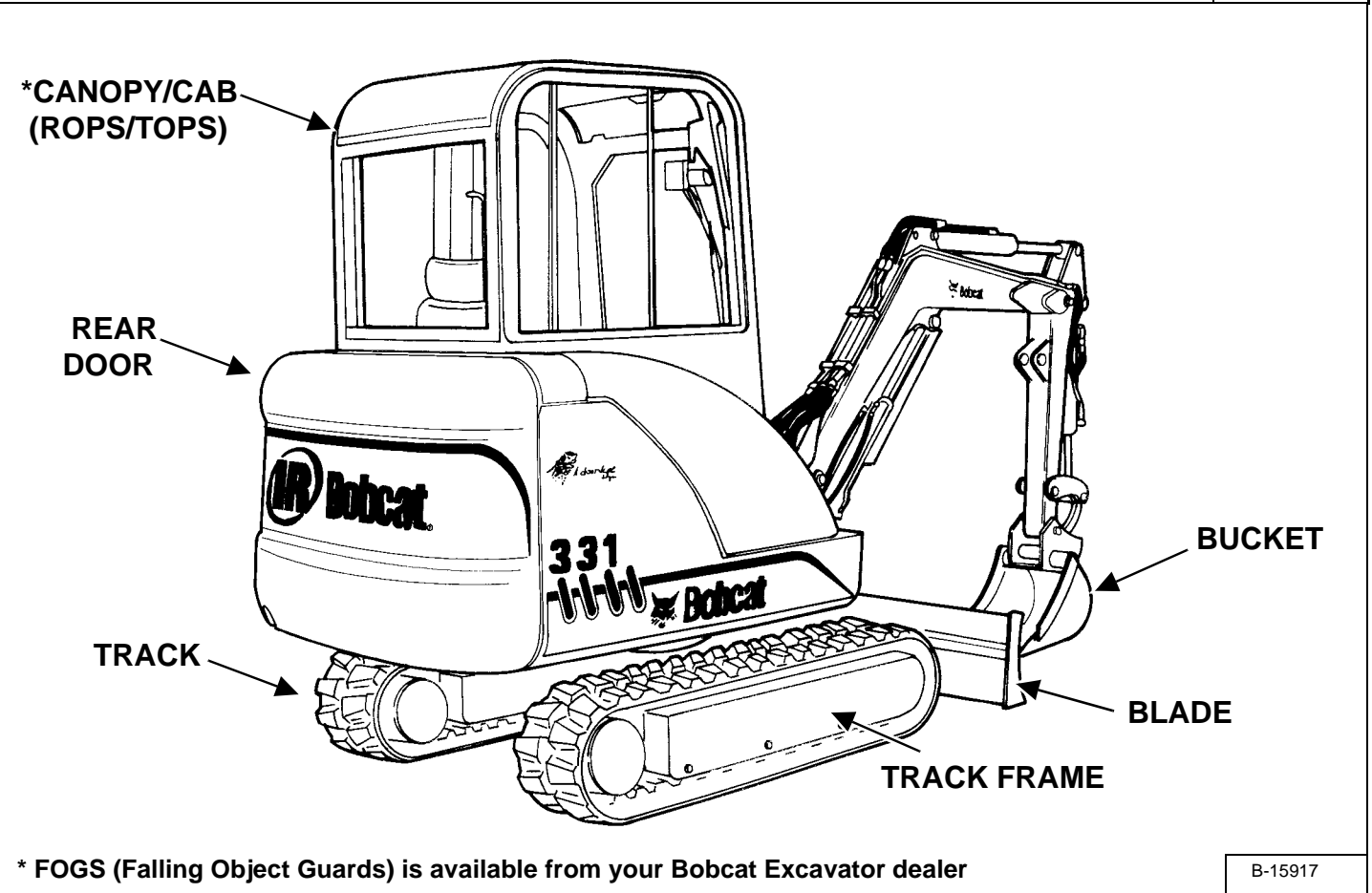

* FOGS (Falling Object Guards) is available from your Bobcat Excavator dealer

B-15917

SAFETY AND MAINTENANCE

SAFETY & MAINTENANCE

AIR CLEANER SERVICE	10-60-1
Daily Check	10-60-1
Replacing The Filters	10-60-1
ENGINE COOLING SYSTEM	10-70-1
Checking The Coolant Level	10-70-1
Cleaning The Cooling System	10-70-1
Replacing The Coolant	10-70-2
ENGINE LUBRICATION SYSTEM	10-90-1
Checking Engine Oil	10-90-1
Replacing Oil And Filter	10-90-1
FUEL SYSTEM	10-80-1
Draining The Fuel Tank	10-80-3
Filling The Fuel Tank	10-80-1
Fuel Specification	10-80-1
Removing Air From The Fuel System	10-80-3
Removing Water From The Fuel Filter	10-80-2
Replacing The Fuel Filter	10-80-2
HEATER AIR FILTERS (WITH CAB OPTION ONLY)	10-61-1
Fresh Air Filter	10-61-1
Recirculation Filter	10-61-1
HYDRAULIC SYSTEM	10-100-1
Checking And Adding Fluid	10-100-1
Diagnostic Couplers	10-100-4
Replacing The Case Drain Filter	10-100-2
Replacing The Hydraulic Filter	10-100-2
Replacing The Hydraulic Fluid	10-100-3
LIFTING AND BLOCKING THE EXCAVATOR	10-10-1
Procedure	10-10-1
LIFTING THE EXCAVATOR	10-12-1
Procedure	10-12-1
LUBRICATING THE EXCAVATOR	10-110-1
Procedure	10-110-1

Continued On Next Page

SAFETY AND MAINTENANCE (CONT'D)

OPERATOR CAB (ROPS/TOPS) (IF EQUIPPED)	10-20-1
Cab Door	10-20-1
Emergency Exit	10-20-1
Front Window	10-20-1
SERVICE SCHEDULE	10-50-1
Chart	10-50-1
SPARK ARRESTOR MUFFLER	10-130-1
Cleaning The Spark Arrestor Muffler	10-130-1
SWING LOCK	10-11-1
Operation	10-11-1
TRAVEL MOTOR	10-120-1
Checking Oil Level	10-120-1
Draining The Travel Motor	10-120-1
TAILGATE	10-40-1
Adjusting The Bumper	10-40-1
Adjusting The Tailgate Latch (Early Models)	10-40-2
Adjusting The Tailgate Latch (Later Models)	10-40-3
Opening And Closing The Tailgate (Early Models)	10-40-1
Opening And Closing The Tailgate (Later Models)	10-40-2
TRANSPORTING THE EXCAVATOR	10-30-1
Procedure	10-30-1

LIFTING AND BLOCKING THE EXCAVATOR

Procedure

WARNING

Instructions are necessary before operating or servicing machine. Read and understand the Operation & Maintenance Manual, Handbook and signs (decals) on machine. Follow warnings and instructions in the manuals when making repairs, adjustments or servicing. Check for correct function after adjustments, repairs or service. Untrained operators and failure to follow instructions can cause injury or death.

W-2003-0199

WARNING

Put jack stands under the front axles and rear corners of the frame before running the engine for service. Failure to use jack stands can allow the machine to fall or move and cause injury or death.

W-2017-0286

Always park the machine on a level surface.

Figure 10-10-1

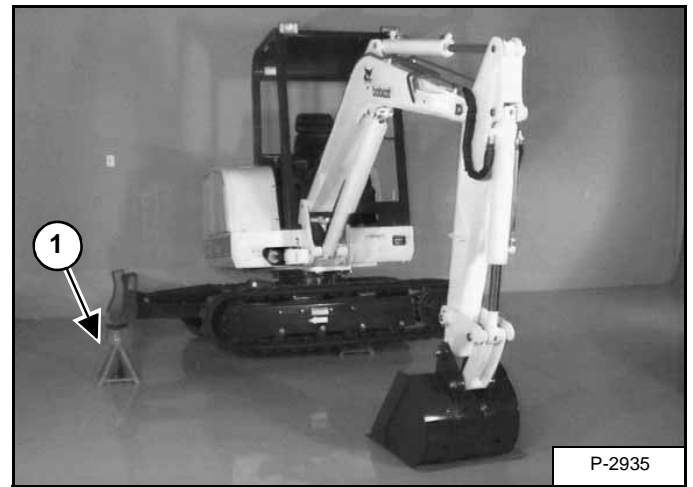

Raise one side of the machine (approximately four inches) using the boom and arm **[Figure 10-10-1]**.

Raise the blade fully and install jack stands under the blade and track frame (Item 1) **[Figure 10-10-1]**. Lower the boom until all machine weight is on the jack stands.

Repeat the procedure for the other side.

Stop the engine.

SWING LOCK

Operation



AVOID INJURY

The swing lock lever must be engaged when transporting the machine.

W-2197-0595



Never use attachments or buckets which are not approved by Bobcat Company. Buckets and attachments for safe loads of specified densities are approved for each model. Unapproved attachments can cause injury or death.

W-2052-0500

Figure 10-11-1

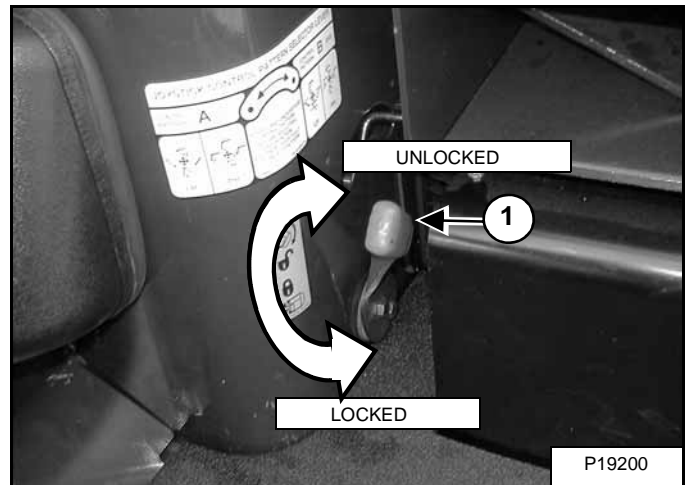

Move the lever (Item 1) **[Figure 10-11-1]** *down* to engage the Swing Lock. When the Swing Lock is engaged (locked), the upperstructure of the excavator is locked to the track frame and will not swing. The upper structure must be parallel to the track frame to engage the Swing Lock.

Move the lever (Item 1) **[Figure 10-11-1]** *up* to disengage the upperstructure from the track frame.

LIFTING THE EXCAVATOR

Procedure

Figure 10-12-1

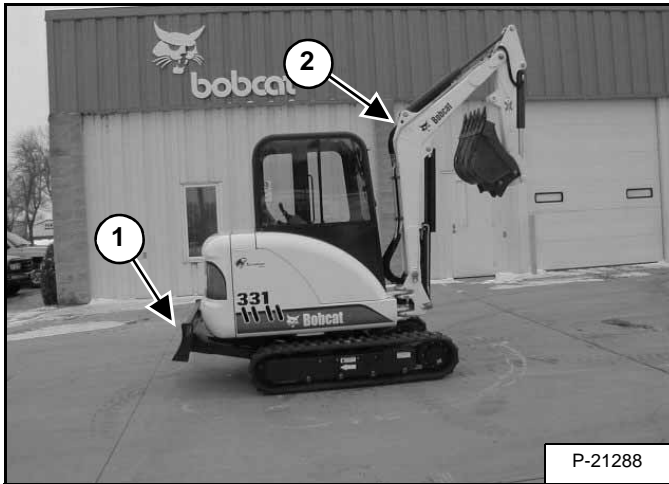

Fully extend the cylinders of the bucket, arm & boom so that the excavator is in the position as shown [Figure 10-12-1].

Raise the blade all the way.

Put the all control levers in neutral and engage the swing lock. (See SWING LOCK on Page 10-11-1.)

WARNING

AVOID INJURY OR DEATH

- Use a lifting fixture with sufficient capacity for the weight of the excavator plus any added attachments.
- Maintain center of gravity and balance when lifting.
- Do not swing boom or upperstructure. Engage the swing locking lever.
- Never lift with operator on machine.

W-2202-0595

Figure 10-12-2

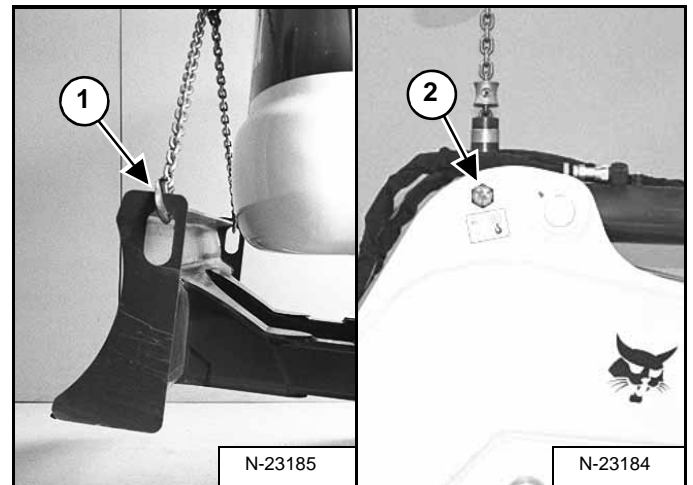

Fasten chains to the ends of the blade (Item 1) [Figure 10-12-1] & [Figure 10-12-2] and up to a lifting fixture above the canopy/cab. The lifting fixture must extend over the sides of the canopy/cab to prevent the chains from hitting the ROPS/TOPS.

Install a 1 inch (25mm) bolt and nut (Grade 5 or 8) through the holes at the top of the boom (Item 2) [Figure 10-12-1] & [Figure 10-12-2]. Fasten a chain from the bolt to the lift fixture.

OPERATOR CAB (ROPS/TOPS) (IF EQUIPPED)

Emergency Exit

The left door and right rear window provide exits.

Figure 10-20-1



Slide the window to the front of the excavator and exit through the side window [Figure 10-20-1].

Figure 10-20-2

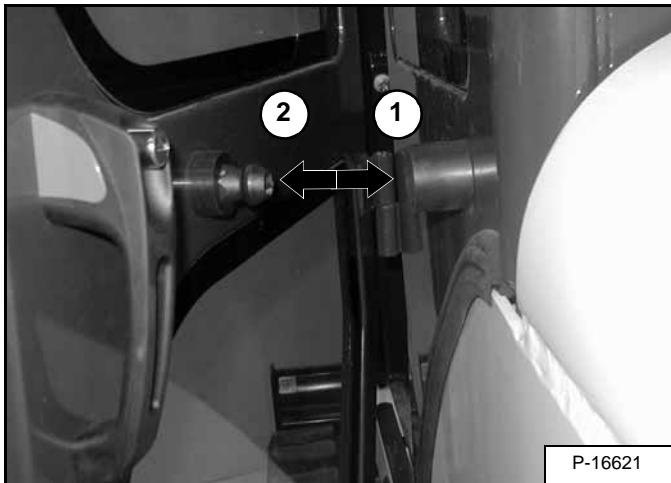

Cab Door

The cab door can be locked with the same key as the starter switch (if equipped).

Push the door all the way open (Item 1) [Figure 10-20-2] until the latch engages to hold the door in the open position.

Firmly pull the door away from the cab (Item 2) [Figure 10-20-2] to disengage the latch and close the door.

Figure 10-20-3

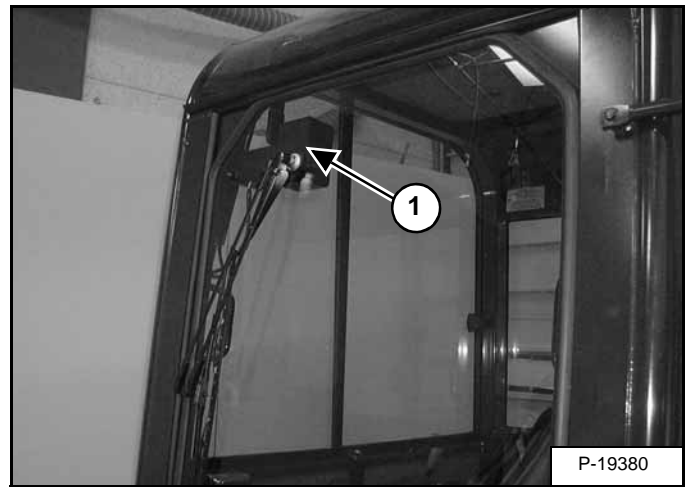

Front Window

The front window is equipped with a wiper (Item 1) [Figure 10-20-3] and washer.

Figure 10-20-4



Opening The Front Window

Release the lower window latch pins and turn to the unlocked position [Figure 10-20-4].

OPERATOR CAB (ROPS/TOPS) (CONT'D)

Front Window (Cont'd)

Figure 10-20-5

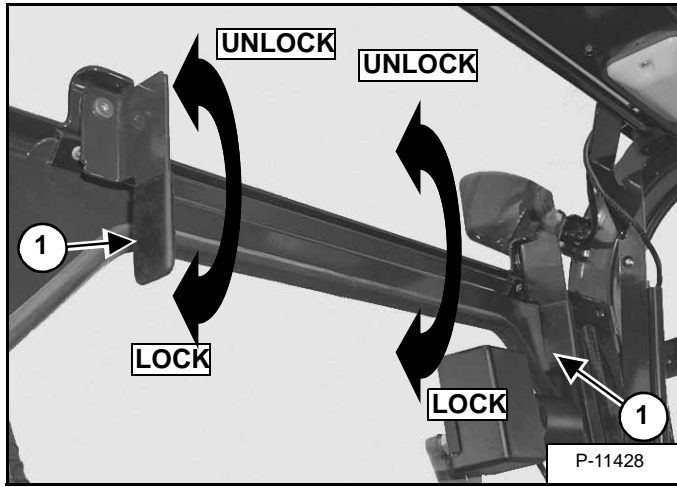

Turn the two top latches (Item 1) [Figure 10-20-5] to the unlocked position.

Figure 10-20-6



Use both window grab handles to pull the top of the window in [Figure 10-20-6].

Continue moving the window in and up over the operator's head until the window engages the pocket at the top, rear of the cab.

Figure 10-20-7

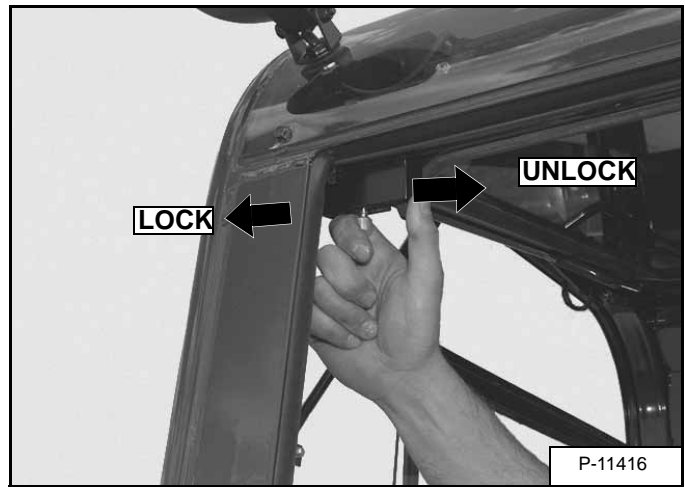

Hold the bottom of the window up and lock the two window latch pins. Make sure that the pins are secured to hold the window up [Figure 10-20-7].

Closing The Front Window

Hold the bottom of the window up and release both window latch pins and put them in the unlocked position [Figure 10-20-7].

Use both window grab handles to pull the window down [Figure 10-20-6].

Rotate the top latches (Item 1) [Figure 10-20-5] to the locked position.

Lock the window latch pins [Figure 10-20-4] at the bottom of the window.

TRANSPORTING THE EXCAVATOR

Procedure



Adequately designed ramps of sufficient strength are needed to support the weight of the machine when loading onto a transport vehicle. Wood ramps can break and cause personal injury.

W-2058-0494

When transporting the machine, observe the rules, motor vehicle laws and vehicle limit ordinances. Use a transport and towing vehicle of adequate length and capacity.

Secure the parking brakes and block the wheels of the transport vehicle.

Align the ramps with the center of the transport vehicle. Secure the ramps to the truck bed and be sure ramp angle does not exceed 15 degrees.

Use metal loading ramps with a slip resistant surface.

Use ramps that are the correct length and width, and can support the weight of the machine.

The rear of the trailer must be blocked or supported when loading or unloading the excavator to prevent the front of the transport vehicle from raising.

Determine the direction of the track movement before moving the machine (blade forward).

Figure 10-30-1



P-21293

Move the machine forward onto the transport vehicle [Figure 10-30-1].

Do not change direction of the machine while it is on the ramps.

Lower the boom, arm, bucket and blade to the transport vehicle.

Stop the engine and remove the key (if equipped).

Put blocks at the front and rear of the tracks.

Figure 10-30-2

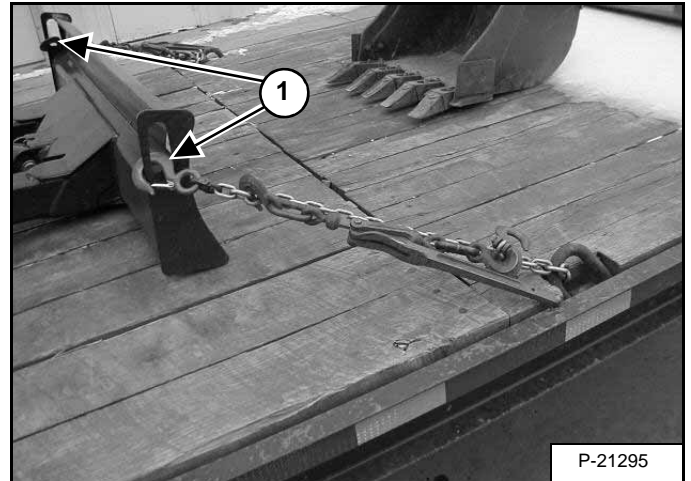

P-21295

Figure 10-30-3

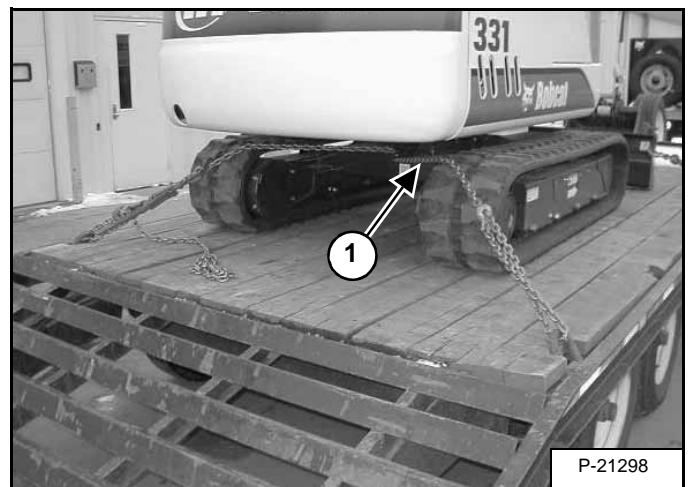

P-21298

Fasten chains to the front corners of the blade (Item 1) [Figure 10-30-2] and to the tie down loop at the rear (Item 1) [Figure 10-30-3] to prevent it from moving when going up or down slopes, or during sudden stops.

Use chain binders to tighten the chains and then safely tie the chain binder levers to prevent loosening.

TAILGATE

Opening And Closing The Tailgate (Early Models)



AVOID INJURY OR DEATH

Never service or adjust the machine when the engine is running unless instructed to do so in the manual.

W-2012-0497



Keep the engine cover closed when operating the machine.

W-2141-0189

Figure 10-40-1

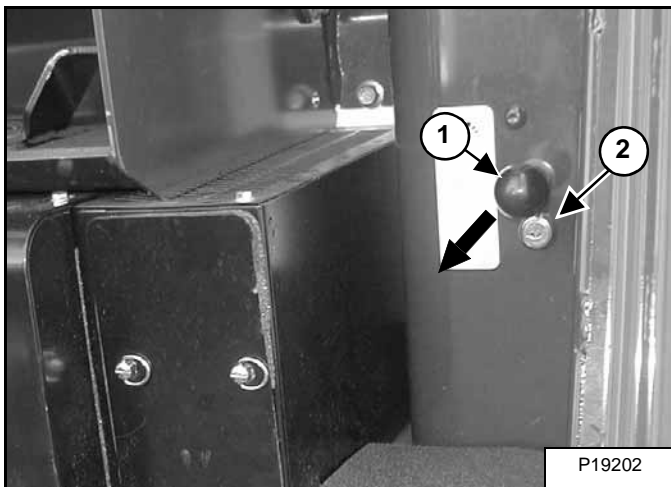

Pull the lever (Item 1) [Figure 10-40-1] to release the tailgate latch.

Pull the tailgate open to provide access for service.

Firmly push the tailgate closed to engage the latch.

The tailgate release can be locked (Item 2) [Figure 10-40-1]. Use the start key to lock/unlock the tailgate.

Adjusting The Bumper

Figure 10-40-2

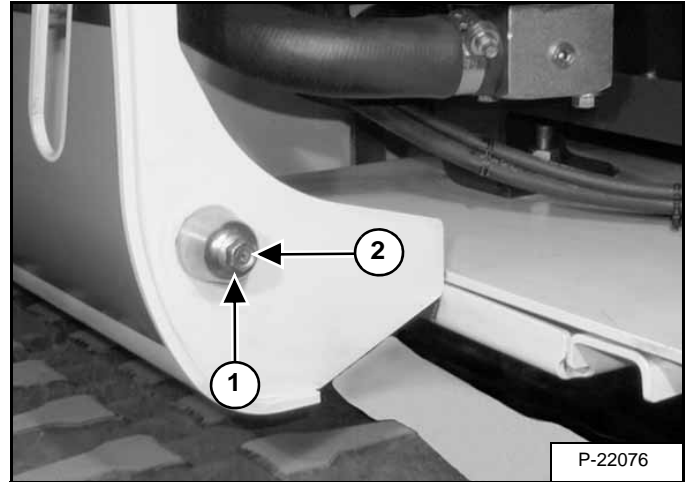
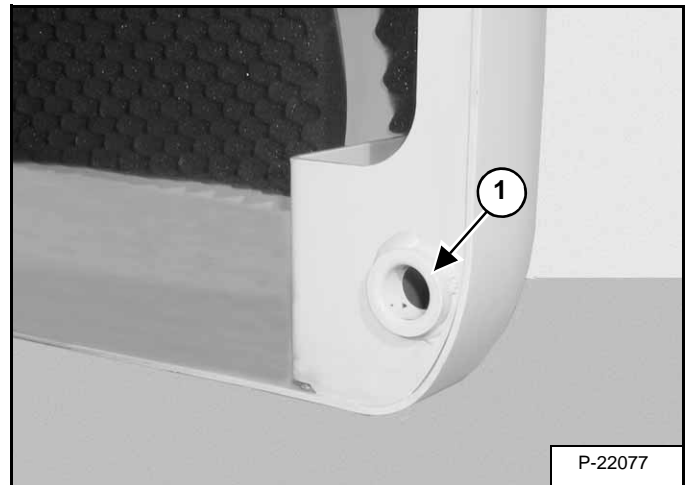

Figure 10-40-3



The door bumper (Item 1) [Figure 10-40-2] can be adjusted for alignment with the door.

Loosen the bolt (Item 2) [Figure 10-40-2] and nut, and position the bumper so it is centered in the socket (Item 1) [Figure 10-40-3] on the lower corner of the door. Tighten the bolt.

Close the rear door before operating the excavator.

TAILGATE (CONT'D)

Adjusting The Tailgate Latch (Early Models)

Figure 10-40-4

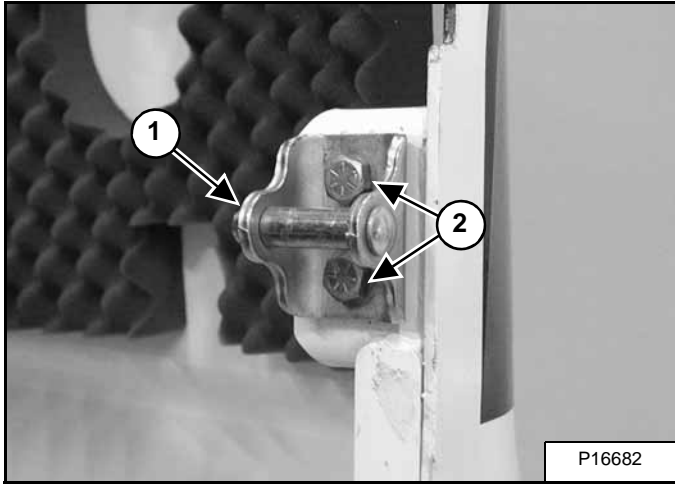

The door catch (Item 1) [Figure 10-40-4] can be adjusted in either direction for alignment with the door latch.

Loosen the bolts (Item 2) [Figure 10-40-4]. Move the door catch as needed and tighten the bolts.

Opening And Closing The Tailgate (Later Models)

! WARNING

AVOID INJURY OR DEATH

Never service or adjust the machine when the engine is running unless instructed to do so in the manual.

W-2012-0497

! WARNING

Keep the rear door closed when operating the machine. Failure to do so could seriously injure a bystander.

W-2020-1285

Figure 10-40-5

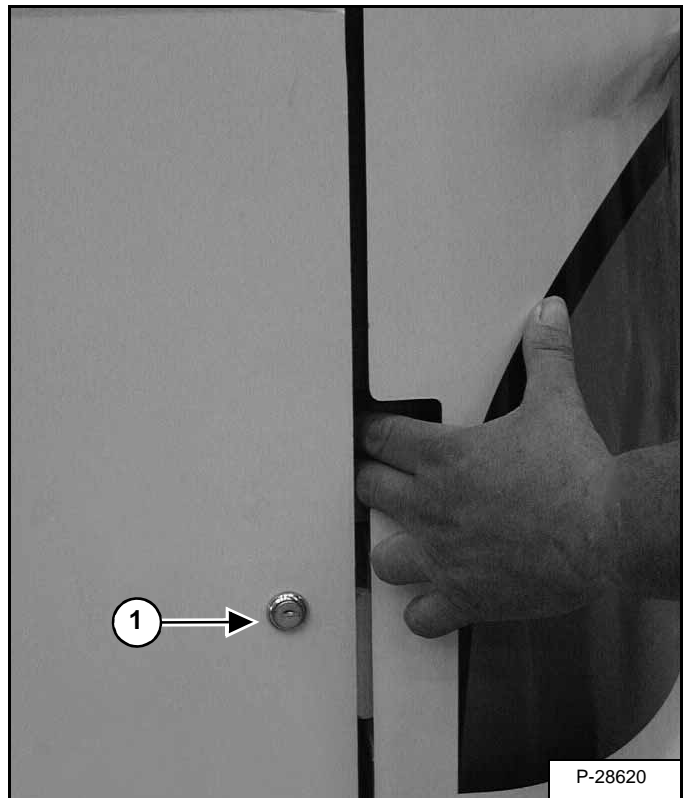

Release the latch [Figure 10-40-5] and pull the tailgate open.

Push firmly to close the tailgate.

The tailgate can be locked (Item 1) [Figure 10-40-5]. Use the start key to lock/unlock the tailgate.

TAILGATE (CONT'D)

Adjusting The Tailgate Latch (Later Models)

Figure 10-40-6

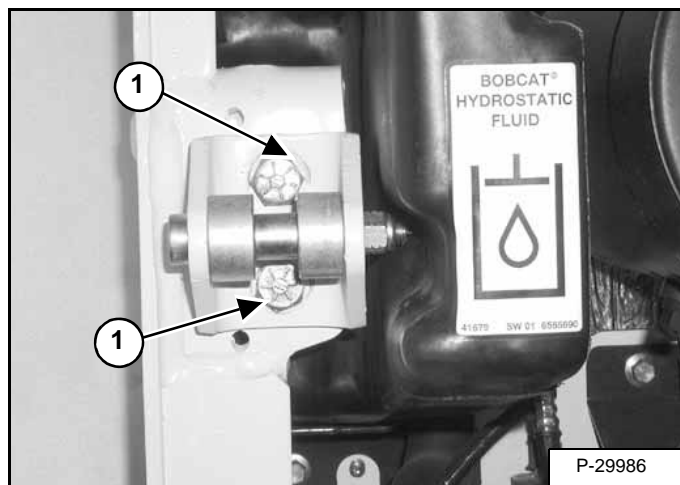

Loosen the two bolts (Item 1) **[Figure 10-40-6]** and move the roller bracket up or down and side to side as needed.

Tighten the bolts.

Close the rear door before operating the excavator.

SERVICE SCHEDULE

Chart

Maintenance work must be done at regular intervals. Failure to do so will result in excessive wear and early failures. The service schedule is a guide for correct maintenance of the Bobcat excavator.

 WARNING	<p>Instructions are necessary before operating or servicing machine. Read and understand the Operation & Maintenance Manual and signs (decals) on machine. Follow warnings and instructions in the manuals when making repairs, adjustments or servicing. Check for correct function after adjustments, repairs or service. Untrained operators and failure to follow instructions can cause injury or death.</p>	W-2003-1285
--	---	--------------------

SERVICE SCHEDULE		HOURS					
ITEM	SERVICE REQUIRED	8-10	50	100	250	500	■1000
Engine Coolant	Check coolant level. Add premixed coolant as needed.						
Engine Oil	Check the engine oil level and add as needed.						
Hydraulic Fluid, Hoses and Tubelines, Reservoir Breather Cap	Check the hydraulic fluid level and add as needed. Check for damage and leaks. Repair or replace as needed.						
Engine Air Filter and Air System	Check condition indicator and empty dust cup as needed. Check air system for leaks.						
Tracks	Check and adjust track tension as needed.						
Indicators and Lights	Check for correct operation of all indicators and lights.						
Operator Canopy / Cab	Check condition. Check mounting hardware.						
Seat Belt	Check condition. Check mounting hardware.						
Safety Signs and Safety Treads*	Check for damaged signs (decals) and safety treads. Replace any signs or safety treads that are damaged or worn.						
Pivot Points	Grease all machinery pivot points. (21 Places) Apply grease to extendable arm (If Equipped).						
Cab Heater Air Filter	Clean the filter as needed.						
Swing Circle and Pinion	Grease three fittings.						
Fuel Tank & Filter	Drain water and sediment from fuel tank and fuel filter.						
Battery	Check battery, cables, connections and electrolyte level. Add distilled water as needed.						
Alternator / Fan Belt	Check condition of belt and adjust as needed.		●				
Spark Arrestor Muffler	Clean the spark chamber.						
Engine Oil and Filter	Replace oil & filter. Use Cd or better grade oil and Bobcat filter.		●				
Fuel Filter	Replace fuel filter.						
Final Drive Case	Check lubricant level in both final drive cases.			◆			
Radiator, Oil Cooler, *A/C	Clean debris from the radiator fins.						
Hydraulic Filter	Replace the filter element.			◆			
Alternator & Starters	Check the alternator and starter connections.		●				
Engine Valves	Check and adjust the engine valve clearance.						
Case Drain Filter	Replace the filter.						
Final Drive Case	Replace lubricant in both final drive cases.						
Engine Cooling System	Drain and flush the cooling system						
Hydraulic System	Replace the hydraulic fluid and filter. Clean the Reservoir.			◆			

* If Equipped

- Also at first 50 Hours
- ◆ Also at first 100 hours
- Or every 6 months.

AIR CLEANER SERVICE

See SERVICE SCHEDULE on Page 10-50-1 for the correct service interval.

Daily Check

Figure 10-60-1

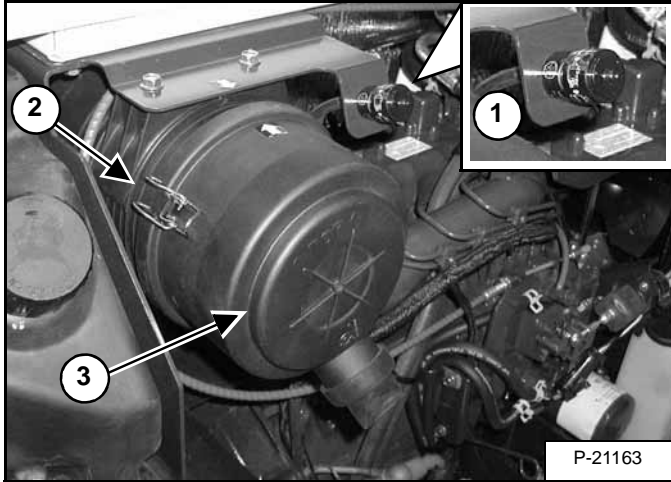

Check the condition indicator (Item 1) [Figure 10-60-1]. If the red ring shows in the condition indicator, the filter element needs to be replaced.

Replace the inner filter every *third* time the outer filter is replaced or as indicated. (See SERVICE SCHEDULE on Page 10-50-1.)

Replacing The Filters

Outer Filter

Release the two fasteners (Item 2) [Figure 10-60-1].

Remove and clean the dust cup (Item 3) [Figure 10-60-1].

Figure 10-60-2

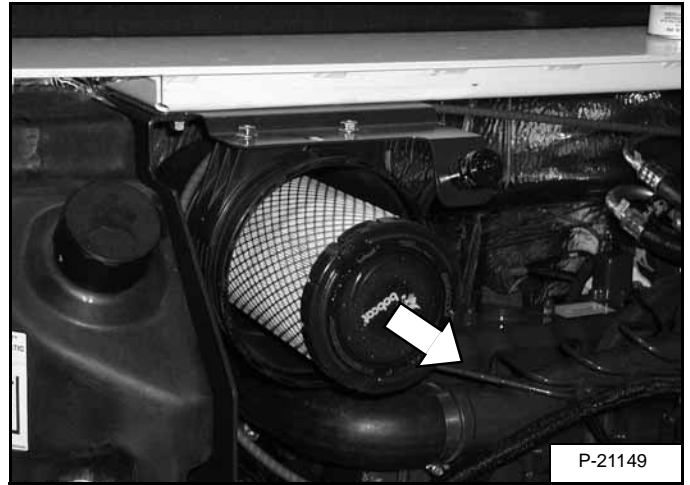

Pull the outer filter from the air cleaner housing [Figure 10-60-2].

Check the housing for damage.

Clean the housing and the seal surface. Do Not use compressed air.

Install a new element.



Suggest:

If the above button click is invalid.

Please download this document

first, and then click the above link

to download the complete manual.

Thank you so much for reading

AIR CLEANER SERVICE (CONT'D)

Replacing The Filters (Cont'd)

Figure 10-60-3

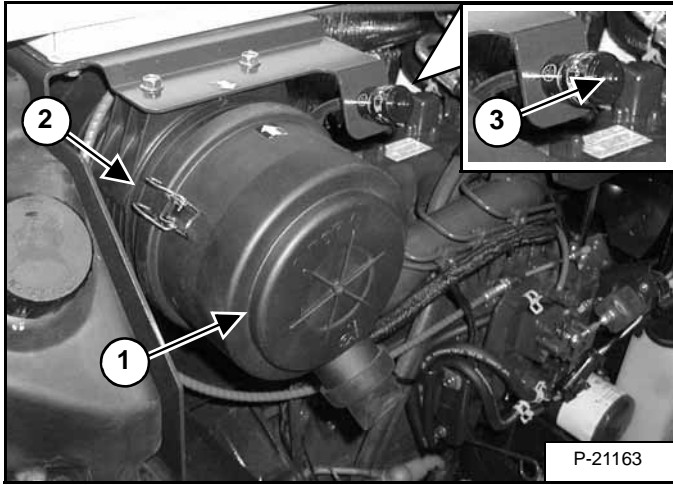

Install the dust cup (Item 1) [Figure 10-60-3] and engage the fasteners (Item 2) [Figure 10-60-3].

Check the air intake hose and the air cleaner housing for damage. Make sure all connections are tight.

Inner Filter

Only replace the inner filter element under the following conditions:

- Replace the inner filter element every *third* time the outer filter is replaced.
- After the outer element has been replaced, press the button (Item 3) [Figure 10-60-3] on the top of the condition indicator and start the engine. Run at full RPM, then reduce engine speed and stop the engine. If the red ring shows in the condition indicator, replace the inner filter element.

Remove the dust cup, outer filter and inner filter.

NOTE: Make sure all sealing surfaces are free of dirt and debris.

Figure 10-60-4

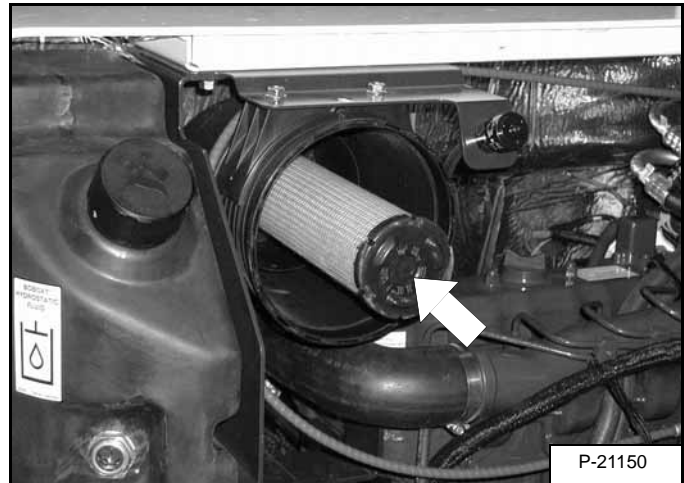

Install the new inner element [Figure 10-60-4].

Install the outer element and the dust cup [Figure 10-60-3].

Press the button on the condition indicator (Item 3) [Figure 10-60-3] to remove the red ring.

<https://www.ebooklibonline.com>

Hello dear friend!

Thank you very much for reading.

Enter the link into your browser.

The full manual is available for immediate download.

<https://www.ebooklibonline.com>