

SERVICE MANUAL

E385C

Crawler Excavators Tier IV

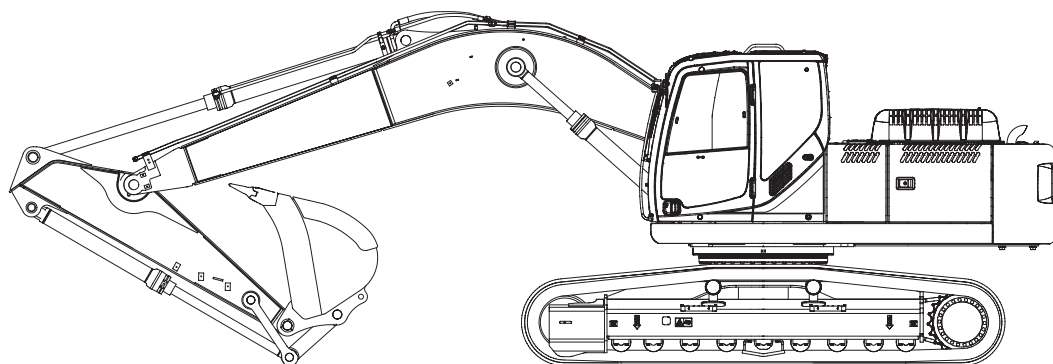

Print no. 84527569A

1st Edition

English 09/11



**WARNING**

Read this manual before operating the machine

Most accidents occurring during work are due to non-observance of simple safety norms and elementary precautions.

Many accidents can be avoided if the causes are known and opportune cautions taken beforehand.

There is no device or protection, no matter how advanced, that may prove so effective at avoiding accidents as a careful and attentive behaviour.

**WARNING**

Ensure that the attachment is safely resting onto the ground before repairing, adjusting or servicing machines fitted with hydraulically, mechanically or cable controlled attachments (such as, excavators, loaders, dozers, scrapers, etc.). Should it be necessary to partially or fully raise the hydraulically, mechanically or cable controlled attachment to gain access to certain items, make sure the attachment is adequately retained in the raised position by means other than the hydraulic lift cylinders, cables and/or mechanical devices used for controlling it.

COPYRIGHT BY NEW HOLLAND KOBELCO CONSTRUCTION MACHINERY S.p.A.

Product Support

Strada di Settimo, 323 - S. MAURO T.SE (TO) ITALY

PAGE NUMBER

- Each page has a number, located on the central lower side of the page. Each page number contains the following information:

Example: **T 1-2-3**

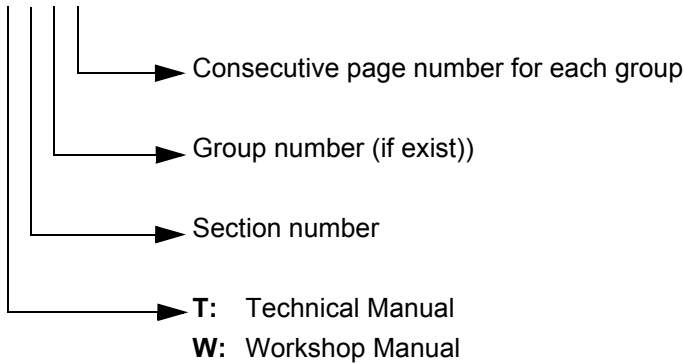

SYMBOLS

In this manual, the following safety alert symbol and signal words are used to alert the reader to the potential for personal injury or machine damage.



This is the safety alert symbol. When you see this symbol, be alert to the potential for personal injury. Never fail to follow the safety instructions prescribed along with the safety alert symbol. The safety alert symbol is also used to draw attention to component/part weights. To avoid injury and damage, be sure to use appropriate lifting techniques and equipment when lifting heavy parts.

UNITS USED

SI Units (International System of Units) are used in this manual.

MKSA system units and English units are also indicated in parentheses just behinds SI units.

Example: 24.5 MPa (250 kgf/cm²)

A table for conversion from SI units to other system units is shown below for reference purposes.

Quantity	To convert from (SI)	Into (Others)	Multiply by
Lenght	mm	in	0.03937
	mm	ft	0.003281
Volume	L	US gal	0.2642
	L	US qt	1.057
	m ³	yd ³	1.308
Mass	kg	lb	2.205
Force	N	kgf	0.10197
	N	lbf	0.2248
Torque	N.m	kgf.m	0.10197
	N.m	lbf.ft	0.7375

Quantity	To convert from (SI)	Into (Others)	Multiply by
Pressure	MPa	kgf/cm ²	10.197
	MPa	psi	145.0
Power	kW	CV-PS	1.360
	kW	HP	1.341
Temperature	°C	°F	°C x 1.8 + 32
Velocity	km/h	mph	0.6214
	min ⁻¹	rpm	1.0
Flow rate	L/min	US gpm	0.2642
	mL/rev	cc/rev	1.0

<https://www.ebooklibonline.com>

Hello dear friend!

Thank you very much for reading.

Enter the link into your browser.

The full manual is available for immediate download.

<https://www.ebooklibonline.com>

MANUAL INDEX



GENERAL SAFETY INFORMATION

Page

Section 1 SAFETY INFORMATION	S1
Section 2 SAFETY PRECAUTIONS	S2
Section 3 SAFETY DECALS	S3

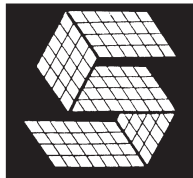

OPERATIONAL PRINCIPLE

Section 1 GENERAL INFORMATION

Group 1 Specifications	T1-1
-------------------------------------	-------------

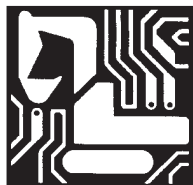

Section 2 SYSTEM

Group 1 Mechatro Control System	T2-1
Group 2 Hydraulic System	T2-2
Group 3 Electrical System	T2-3

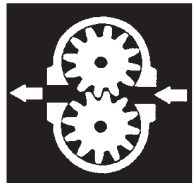

Section 3 COMPONENT OPERATION

Group 1 Hydraulic Pump Assy	T3-1
Group 2 Pilot Valve	T3-2
Group 3 Control Valve	T3-3
Group 4 Swing Device	T3-4
Group 5 Travel Device	T3-5
Group 6 Swivel Joint	T3-6
Group 7 Cylinders	T3-7
Group 8 Air Conditioner system	T3-8
Group 9 Electrical Equipment	T3-9



OPERATIONAL PERFORMANCE TEST

Section 4 OPERATIONAL PERFORMANCE TEST

Group 1 Introduction	T4-1
Group 2 Standard Performances	T4-2
Group 3 Test Procedures	T4-3
Group 4 Mechatro Controller	T4-4



TROUBLESHOOTING

Section 5 TROUBLESHOOTING

Group 1 Troubleshooting (by error codes)	T5-1
Group 2 Troubleshooting (by trouble)	T5-2

REPAIR INSTRUCTIONS



Section 1 GENERAL INFORMATION

Group 1	Precautions for Disassembly and Assembly.....	W1-1
Group 2	Tightening Torque	W1-2



Section 2 UPPERSTRUCTURE

Group 1	Upperstructure	W2-1
Group 2	Pump Device.....	W2-2
Group 3	Control Valve	W2-3
Group 4	Swing Device	W2-4
Group 5	Pilot Valve	W2-5



Section 3 UNDERCARRIAGE

Group 1	Swing Bearing	W3-1
Group 2	Travel Device	W3-2
Group 3	Swivel Joint	W3-3
Group 4	Track Adjuster	W3-4
Group 5	Front Idler	W3-5
Group 6	Upper and Lower Roller	W3-6
Group 7	Tracks	W3-7



Section 4 FRONT ATTACHMENT

Group 1	Front attachment.....	W4-1
----------------	-----------------------	------

GENERAL SAFETY INFORMATION

INDEX



Section 1	SAFETY INFORMATION
Section 2	SAFETY PRECAUTIONS
Section 3	SAFETY DECALS

SAFETY RULES

GENERALITIES

Read the Operator's manual carefully before starting, operating, maintaining, fuelling or servicing the machine.

Carefully read the explanation to each and all safety signs in the special section of this Manual before starting, operating, maintaining, fuelling or servicing the machine.

Machine-mounted safety decals are colour coded yellow with black borders when they refer to points where special ATTENTION must be paid and failure to observe them may cause a serious DANGER to the integrity of machine operators.

It is fundamental that all machine operators know very well the meaning of each safety plate as this considerably decreases operating hazards and accidents.

Do not allow unauthorised personnel to operate or service this machine.

Do not wear rings, wrist watches, jewellery, loose or hanging garments, such as ties, torn clothing, scarves, unbuttoned or unzipped jackets that can get caught in moving parts. Wear certified safety clothes such as: hard hat, no-slip footwear, heavy gloves, ear protection, safety glasses, reflector vests, respirators every time the job requires it. Ask your employer about safety regulations in force and protective equipment.

Always keep the operator's compartment, step plates, grab-rails and handles clean and clear of foreign objects, oil, grease, mud or snow to minimise the danger of slipping or stumbling. Remove mud or grease from your shoes before operating the machine.

Do not jump on or off the machine. Always keep both hands and one foot, or both feet and one hand in contact with steps and/or grab rails.

Do not use controls or hoses as hand holds. Hoses and controls are movable parts and do not provide solid support. Besides, controls may be inadvertently moved and cause unexpected movement of the machine or its attachments.

Never operate the machine or its attachments from any position other than sitting in the driver's seat. Keep head, body, limbs, hands and feet inside the operator's compartment at all times to reduce exposure to external hazards.

Be careful of possible slippery conditions of the steps and hand rails as well as of the ground around the machine. Wear protective boots or shoes with the soles made of highly no-slip rubber

Do not leave the machine until it has come to a complete stop.

Always check height, width and weight limitations which may be encountered in the working site and ensure the machine does not exceed them.

Assess exact paths of gas ducts, water mains, telephone lines, sewers, overhead and underground electric lines and all other possible obstacles.

Such paths should be opportunely defined by competent Authorities. If necessary, require that the service is interrupted or said installations are moved prior to starting the work.

Define the rear upperstructure swing area and provide for opportune barriers to prevent access into it.

Never exceed machine lifting capacity.

Remain within the limits shown in the loading capacity chart which located on the machine.

STARTING

Never start or operate a failed machine. Walk all around the machine before mounting.

Before operating the machine, make sure that any possible dangerous condition has been properly removed. Before starting machine, always check that all controls are in the neutral position and the safety lever is in the LOCK position. Immediately report any malfunction of parts or systems to the maintenance managers for proper action.

Prior to starting the engine, check, adjust and lock the driver's seat for maximum riding comfort and control accessibility. Prior to operating the machine and/or its attachments, check that bystanders are outside the machine operating range. Sound the horn.

Obey all hand signals, safety indications and signs.

Due to the presence of flammable fluids, never check fuel level, refuel, charge the batteries in the presence of smoking materials, open flames or sparks.

Adjust all rear-view mirrors for maximum visibility of the area behind the machine.

Ensure that engine speed is appropriate to the job to be carried out.

If any hydraulic control or system exhibits erratic performance or responds abnormally, have the machine checked for air in the system.

Air in these circuits may cause incorrect movements with consequent accident hazard. Refer to the Operator's manual about corrective action to be taken.

OPERATING

Do not run the engine in closed buildings without proper ventilation capable to remove harmful exhaust gases which concentrate in the air.

Keep the operator's compartment free of foreign objects, especially if not firmly secured. Never use the machine to transport objects, unless proper securing points are provided.

Do not carry riders on the machine. Study and familiarise with escape routes alternative to normal exit routes. For your personal safety, do not climb on or off the machine while it is in motion.

Make sure that bystanders are clear of the machine operating range before starting the engine and operating the attachment. Sound the horn.

Obey all hand signals, safety indications and signs.

When backing, always look to where the machine is to be moved.

Be alert of the position of bystanders. Should someone enter the work area, stop the machine. Maintain a safe distance from other machines or obstacles to ensure required visibility conditions.

Always give way to loaded machines.

Maintain a clear vision of the surroundings of the travel or work area at all times. Keep cab windows clean and repaired.

When pulling loads or towing through a cable or chain, do not start suddenly at full throttle. Take-up slack carefully. Avoid kinking or twisting chains or cables.

Carefully inspect the towing items for flaws or problems before proceeding. Do not pull through a kinked chain or cable as the high anomalous stresses existing in this condition may induce failures in the kinked portion.

Always wear heavy gloves when handling chains or cables.

Chains and cables should be securely anchored using suitable hooks. Anchor points should be strong enough to withstand the expected load.

Keep anyone clear of anchor points and cables or chains.

Do not pull or tow unless the operator's compartments of the machines involved are properly protected against possible backlash in case of cable or chain failure or detachment.

Be alert of soft ground conditions close to newly constructed walls. The fill material and machine weight may cause the wall to collapse under the machine.

In darkness, check area of operation carefully before moving in with the machine. Use all lights provided. Do not move into low visibility areas.

If the engine tends to slow down and stall for whatever reason under load or at idle, immediately

report this problem to the maintenance managers for proper action.

Do not operate the machine until this condition is corrected. Regularly check all exhaust system components, as exhaust fumes are toxic for the operator.

Operators must know the performance of the machine they are driving. When working on slopes or near sudden level drops in the terrain, pay attention not to lose adherence and avoid loose soft ground since overturn or loss of machine control could result.

If noise level is high and exceeds 90 dB (A) over 8 hours at the operator's ear, wear approved ear protection in compliance with local regulations.

Do not operate the machine if you are extremely tired or feel ill. Be especially careful towards the end of the working shift.

Where removable counterweights are provided, do not operate the machine if they have been removed.

When operating the machine, keep in mind height limits of overhead doors, arches, overhead cables and lines as well as width limits of corridors, roads and narrow passages.

Also, get to know load limits of the ground and paving type of the ramps you are to work on.

Beware of fog, smoke or dust that obscure visibility.

Always inspect the working area to identify potential risks such as: inclines, overhangs, trees, demolition rubble, fires, ravines, steep slopes, rough terrain, ditches, crowns, ridge trenches, diggings in traffic areas, crowded parking lots, crowded service areas, fenced zones. In such conditions, proceed with extreme care.

Whenever possible, avoid crossing over obstacles such as very rough terrain, rocks, logs, steps, ditches, railroad tracks.

When obstructions must be crossed, do so with extreme care and at a square angle, if possible. Slow down.

Ease up to the break-over point, pass the balance point slowly and ease down the other side also using the attachment, if necessary.

To overcome deep trenches or sinking ground, place the machine perpendicular to the obstacle, drastically reduce ground speed and start crossing using also the attachment if necessary, only after assessing that ground conditions allow the traverse safely and without risks.

The gradient you may attempt to overcome is limited by factors such as ground conditions, load being handled, machine type and speed, and visibility. There is no substitute for good judgement and experience when working on slopes.

Avoid operating the attachment too close to an overhang or high wall, either above or below the machine. Beware of caving edges, falling objects and landslides. Remember that such hazards are

likely to be concealed by bushes, undergrowth and such.

Avoid bushes, logs and rocks. Never drive over them, nor over any other surface irregularities that discontinue adherence or traction with the ground, especially near slopes or drop-offs.

Be alert to avoid changes in adherence conditions that could cause loss of control. Work with extreme care on ice or frozen ground and on stepped slopes or near drop-offs.

The word "bulldozing" generally refers to work in virgin rough terrain, characterised by the presence of all the perils and risks listed above. We emphasise the danger represented in these conditions by large tree limbs (possibly falling on the machine) and large roots (which may act as a leverage under the machine when up-rooted and cause the unit to overturn).

Position the machine dependent upon the loading and unloading areas in order to swing leftwards to load to obtain best visibility.

Never use the bucket or attachment as a man lift or carry riders. Never use the machine as a work platform or scaffolding. The machine must not be improperly used for works not consistent with its features (such as pushing railway cars, trucks or other machines).

Always pay attention to people within the machine operating range.

Never move or stop the bucket, other loads or the attachment above ground personnel or truck cabs.

Ensure the truck driver is in a safe place before loading the truck.

Load trucks from side or rear.

Use only the type of bucket recommended considering machine type, materials to be handled, material piling up and loading characteristics, ground type and other typical conditions of the work to be performed.

When transporting a loaded bucket, keep it as rolled-back as possible. Keep boom and arm as low as possible.

Ground speed should be adequate to the load and ground conditions.

The load must always be properly arranged in the bucket; move with extreme care when transporting oversize loads.

Do not lift and move the bucket overhead where persons are standing or working, nor downhill when working on a slope as this would decrease machine stability. Load the bucket from the uphill side.

Loads to be raised using the machine should be exclusively hooked to the hitch specially provided.

The excavator is no lifting and transportation means, therefore it should not be used to position loads accurately. Should it be exceptionally used to lift and

lay building components, special caution must be taken as follows:

- The machine must be equipped compulsorily with the appropriate variant provided upon request.
- Secure the loads to be raised using cables or chains fastened with appropriate hooking mechanisms.
- Nobody should be allowed to remain under the raised load or within the excavator operating range for any reason whatever.

Never exceed specified loading capacity. Incorrect fastening of slings or chains may cause boom/arm failure or failure of the lifting means with consequent bodily injuries and even death.

Always ensure that slings and chains used for lifting are adequate to the load and in good condition.

All loading capacities are referred to the machine on a level surface and should be disregarded when working on a slope.

Avoid travelling across slopes. Proceed from uphill downhill and vice-versa. If machine starts slipping sideways when on a slope, lower the bucket and thrust bucket teeth into the ground.

Working on slopes is dangerous. Grade the working area if possible. Reduce work cycle time if it is not possible to grade the working area.

Do not move full bucket or a load from uphill downhill as this would reduce machine stability. Do not work with the bucket turned to the uphill side.

Do not work with the bucket turned uphill as counterweights protruding downhill would reduce machine stability on the slope and increase risk of overturning.

We recommend to work on slopes with the bucket downhill, after checking machine stability with the bucket empty and attachment retracted, by slowly swinging the upper structure by 360°.

Position the carriage at a right angle relative to slopes, hanging walls, etc. to exit the working area easily.

Keep the machine sufficiently far from the ditch edge.

Never dig under the machine.

Should it be necessary to dig under the machine, always ensure that digging walls are opportunely propped up against landslide to prevent the machine from falling into the trench.

Do not swing the upperstructure, raise the load or brake abruptly if not required. This may cause accidents.

Prior to beginning the work near gas distribution mains or other public utilities:

- Contact the company owner of the gas mains or its nearest branch before starting the work.
- Define together which precautions should be taken to guarantee work safety.
- Decrease work speed. Reaction time could be too slow and distance evaluation wrong.
- When working near gas mains or other public utilities installations, appoint a person in charge of signalling duties. This person will have the responsibility of observing the machine, any part of it and/or the load approaching the gas mains from a standpoint more favorable than the Operator. This signal man (flag-man) must be in direct communication with the Operator and the Operator must pay undivided attention to the signals supplied.
- The gas distributing Company, if previously advised and involved in the work, as well as machine Operator, Owner and/or any natural person or legal entity having rent or leased the machine or being responsible at the time by contract or by law, are liable for the adoption of the necessary precautions.

Working near electric lines can be very dangerous, therefore some special precautions must be observed.

Within this Manual, "work near electric lines" means when the attachment or load raised by the excavator (in any position) may reach the minimum safety distance established by local or international Safety Regulations.

To work without risks, keep maximum possible distance from electric lines and never trespass minimum safety distance.

- Contact the Company owner of the electric lines or its nearest branch before starting the work.
- Define together with the Company representative which precautions should be taken to guarantee work safety.
- All electric lines should be considered as operative live lines even though it might be well known that the line in question is out of work and visibly connected to the ground.
- The Electric Power Company, if previously advised and involved in the work, as well as machine Operator, Owner and/or any natural person or legal entity having rent or leased the machine or being responsible at the time by contract or by law, are liable for the adoption of the necessary precautions.
- Decrease work speed. Reaction time could be too slow and distance evaluation wrong.
- Warn all ground personnel to keep clear of the machine and/or load at all times. If the load has to be guided down for laying, consult the Electric Power Company to know which precautions should be taken.

- Appoint a person in charge of signalling duties. This person will have the responsibility of observing the machine, any part of it and/or the load approaching the electric lines from a standpoint more favorable than the Operator. This signal man (flag-man) must be in direct communication with the Operator and the Operator must pay undivided attention to the signals supplied.

When working in or near pits, in ditches or very high walls, check that the walls are sufficiently propped up to avoid cave-in hazards.

Pay the utmost attention when working near overhang walls or where landslides may take place. Make sure that the support surface is strong enough to prevent landslides.

When digging, there is the risk of cave-ins and landslides.

Always check ground conditions and conditions of the material to be removed. Support everywhere it is required to prevent possible cave-ins or landslides when:

- Digging near previous trenches filled with material.
- Digging in bad ground conditions.
- Digging trenches subject to vibration from railroads, working machines or highway traffic.

STOPPING

When the machine is to be stopped for whatever reason, always check that all controls are in the neutral position and that the safety lever is on the lock position to guarantee risk-free start-up.

Never leave the machine unattended with the engine running.

Prior to leaving the driver's seat, and after making sure that all people are clear of the machine, slowly lower the attachment until resting it safely to the ground. Retract possible auxiliary tools to the closed safety position.

Check that all controls are in the neutral position. Move engine controls to the shut-down position. Switch off the key-start switch.

Park the machine in a non-operating and no-traffic area. Park on firm level ground. If this is not possible, position the machine at a right angle to the slope, making sure there is no danger of uncontrolled sliding.

If parking in traffic lanes cannot be avoided, provide appropriate flags, barriers, flares and other signals as required to adequately warn the oncoming drivers.

Always switch off the key-start switch before cleaning, repairing, or parking the machine to prevent accidental unauthorised start-up.

Never lower the attachment or auxiliary tools other than from sitting in the operator's seat. Sound the

horn. Make sure that nobody is within the machine operating range. Lower the attachment slowly.

Securely block and lock the machine every time you leave it unattended. Return keys to the safe place previously agreed upon. Perform all necessary operations for stopping as detailed in the Operator's manual.

Drive the machine far from pits, trenches, rocky hanging walls, areas with overhead electric lines, and slopes before stopping it at the end of the working day.

Move all controls to the position specified for machine stopping.

Never park on an incline without accurately blocking the machine to prevent unexpected movement.

Follow stopping instructions contained in the Operator's manual.

MAINTENANCE

Carefully read the Operator's manual before starting, operating, maintaining, fuelling or servicing the machine in any manner.

Read all safety decals mounted on the machine and observe instructions they contain before starting, operating, repairing, fuelling or servicing the machine.

Do not allow unauthorised personnel to repair or service the machine.

Follow all recommended maintenance and service procedures.

Do not wear rings, wrist watches, jewellery, loose or hanging garments, such as ties, torn clothing, scarves, unbuttoned or unzipped jackets that can get caught in moving parts. Wear certified safety clothes such as: hard hat, no-slip footwear, heavy gloves, ear protection, safety glasses, reflector vests, respirators when required. Ask your employer about safety regulations in force and protective equipment.

Do not use controls or hoses as hand holds. Hoses and controls are movable parts and do not provide solid support. Besides, controls may be inadvertently moved and cause unexpected movement of the machine or its attachments.

Do not jump on or off the machine. Always keep both hands and one foot, or both feet and one hand in contact with steps and/or grab rails.

Never service the machine with someone sitting in the driver's seat, unless this person is an authorised operator assisting in the maintenance being carried out.

Keep the operator's compartment, step plates, grab rails and handles clear of foreign objects, oil, grease, mud or snow to minimise the danger of slipping or stumbling.

Clean mud or grease from your shoes before climbing on the machine or driving it.

Never attempt to operate the machine or its attachments from any position other than sitting in the operator's seat.

Keep the driver's seat free from foreign objects, especially if these are not secured.

Should it be necessary to move the attachment for maintenance purposes, do not raise or lower the attachment from any other position than sitting in the operator's seat. Before starting the machine or moving its attachment, sound the horn and require that nobody remains near the machine.

Raise the attachment slowly.

Always lock all moving components or parts of the machine that must be lifted for maintenance purposes using adequate external means as required by local and national regulations. Do not allow anyone to pass or stay near or below a raised attachment. If you are not absolutely sure about your safety, do not stay or walk under a raised attachment.

Do not place head, body, limbs, hands, feet or fingers near articulated cutting edges deprived of the necessary guards, unless they are suitably and safely locked.

Never lubricate, repair or adjust the machine with the engine running, except when this is specifically required by the Operator's manual.

Do not wear loose clothing, jewellery near rotating parts.

When service or maintenance require access to areas that cannot be reached from the ground, use a ladder or step platform conforming to local or national regulations to reach the working area. If such means are not available, use machine grab rails and steps. Always perform all service or maintenance work with the greatest care and attention.

Shop and/or field service platforms or ladders should be manufactured and maintained in accordance with local or national safety regulations in force.

Disconnect batteries and label all controls to warn that service work is in progress, according to local and national safety regulation requirements.

Block the machine and all attachments to be raised according to local and national safety regulation requirements.

Do not check or fill fuel tanks or install batteries near burning or smoking materials and open flames due to the presence of flammable vapours.

The fuel filler pipe nozzle must be constantly kept in contact with the filler neck and this even before fuel starts flowing in. Keep this contact from the beginning

to the end of the fuelling operation to avoid possible generation of sparks due to static electricity.

Use a truck or trailer to haul a failed machine. Should it be necessary to tow it, provide for suitable danger signals as required by the local norms and regulations and observe recommendations given in the Operator's manual. Load/unload the machine on firm level ground providing safe support to the wheels of the truck or trailer. Use strong access ramps, with adequate height and angle. Keep the trailer flatbed free of mud, oil or slippery materials. Tie the machine securely to the trailer and block carriages and upperstructure.

Never align holes or slots using your fingers; always use appropriate aligning tools.

Remove all sharp edges and burrs from re-worked parts.

Use only approved and effectively grounded auxiliary power sources for heaters, battery chargers, pumps and similar equipment to reduce electrical shock hazard.

Lift and handle heavy components using hoisting devices of appropriate capacity. Ensure the parts are supported by appropriate straps and hooks.

Use lifting eyes provided to this aim.

Pay attention to bystanders near the lifting area.

Never pour gasoline or diesel fuel into open containers. Never use gasoline, solvents or other flammable fluids to clean parts. Use proprietary certified non-flammable, non-toxic solvents only.

When using compressed air to clean parts, wear safety glasses with side shields. Limit pressure to max 2 bar, in accordance with local and national safety regulations in force.

Do not run the engine of this machine in closed buildings without proper forced ventilation capable to remove toxic exhaust gases concentrating in the air.

Do not use open flames as light sources to look for leaks or inspect anywhere on the machine.

Make sure that all mechanical tools provided are in good condition at all times. Never use tools with mushroomed or damaged heads. Always wear eye protections with side shields.

Move with extreme care when working under, on or near the machine or its attachments.

In case of attachment tests during which the engine should be kept running, a qualified operator must sit in the driver's seat at all times while the mechanic is at work.

Keep hands and clothes far off moving parts.

Stop the engine and move the safety lever to the lock position before starting adjusting or repairing an assembly.

Do not carry out any work on the attachment without prior authorisation. Observe maintenance and repair procedures.

In case of field service, move the machine to level ground and block it. If work on an incline cannot be avoided, securely block the machine and its attachments. Move the machine to level ground as soon as possible.

Do not twist chains and cables. Never use a twisted chain or cable for lifting or pulling. Always wear safety gloves to handle chains or cables.

Be sure chains and cables are firmly fastened and that the anchor point is strong enough to withstand the expected load.

Keep all bystanders clear of the anchor point, cables or chains. Do not pull or tow unless the operator's compartments of the machines involved are fitted with proper guards against cable or chain backlash.

Keep the maintenance area clean and dry at all times.

Clean immediately all water and oil spillage.

Do not pile up oily or greasy rags as they represent a major fire hazard. Always store them in closed metal containers.

Before starting the machine or its attachment, check, adjust and lock the operator's seat. Also ensure that nobody is within the machine or attachment operating range before starting or operating the machine and/or its attachments.

Sound the horn.

Rust inhibitors are volatile and flammable.

Prepare parts in well ventilated areas. Keep open flames away.

Do not smoke.

Store containers in a cool well ventilated place where they could not be reached by unauthorised people.

Do not carry loose objects in your pockets that might fall unnoticed into open compartments.

Wear appropriate safety clothing such as hard hat, safety shoes and gloves, safety glasses when splinters or other particles may be ejected.

Wear the appropriate welder's equipment such as dark safety glasses or mask, hard hat, protective clothing, safety gloves and footwear always while welding or arc-cutting. Wear dark safety glasses when you are near a welding in progress.

Do not look the welding arc without proper eye protection.

Become acquainted with all your jacking equipment and their capacity.

Ensure that the jacking point on the machine is appropriate for the load applied. Also, be sure the supports under the jack and between the jack and the machine are appropriate and stable.

Any equipment supported by a jack represents a possible hazard. Always support the load onto appropriate blocking means as a safety measure before proceeding with service or maintenance work,

in compliance with local or national safety regulations.

Metal cables produce steel splinters. Always wear certified protection clothes such as safety gloves and glasses while handling them.

Handle all parts carefully. Keep hands and fingers away from gaps, gears, and similar. Always use and wear certified safety clothes such as safety glasses, gloves and footwear.

The attachment is kept constantly in position by an oil column trapped into the high pressure circuit. Lower the attachment to the ground and relieve pressure from all circuits prior to carrying out any type of maintenance or repair work.

Do not service or repair the machine if it is parked downhill. If this is unavoidable, in case of emergency, block the carriages to prevent unexpected movement, particularly if the work is to be carried out on the final reduction units or travel motors.

Consult the Operator' manual for correct maintenance procedure.

Areas near articulated cutting edges where mechanical parts are in motion are where personal injuries are most likely to occur. Pay attention to prevent possible part movements by means of blocks or by keeping clear of such zones when motion may take place during maintenance or repair.

Move the hydraulic system lock safety lever to the lock position when stopping the machine for whatever reason.

Always install the safety stays for the hood and other hinged covers before performing any maintenance or repair work in the engine compartment.

TRANSFERS AND TRANSPORTATION

Before moving or transporting the machine, block upperstructure swing to prevent accidental movement.

Pay particular attention during transfer on inclines, both uphill and downhill. Keep the bucket in a position to provide a possible anchor point into the ground in case of slipping.

Never transfer the machine in the working site, in a crowded area, or near people without having at least one person charged with hand-signals who could guide the Operator.

Sound the horn to inform that you are about to move off.

It is necessary to know load limits of bridges and dimensional limits of tunnels. Such limits must never be exceeded. You should also know machine height, width, and weight. Have a signal-man help you when clearances are limited.

Check distance between boom/arm and dimensional limits during transfer or transportation.

Rough terrain may cause the machine to sway and roll to such an extent that boom/arm could get to contact electric lines or other obstacles. Cross obstacles at a right angle at low speed. Pay attention to machine shaking when the centre of gravity overcomes the obstacle.

Keep the bucket down at all times during transfers.

Drive with the lights on and use appropriate signals and flags.

Get to know and respect local and national regulations.

Consider boom/arm and upperstructure dimensions while turning.

Use a ramp to load the machine on a trailer. If a ramp is not available, fabricate one using blocks. The ramp should be sufficiently strong to support machine weight. Always load and unload on level surface.

Tow the machine following the instructions contained in the Operator's manual.

ENGINE

Do not run the engine in closed buildings without proper ventilation capable to remove harmful exhaust fumes.

Do not place head, body, limbs, feet, hands or fingers near rotating fans or belts. Be especially careful near blower fans.

Loosen the radiator cap very slowly to relieve system pressure before removing it. Always top-up coolant level with the engine off or idling if hot.

Keep the exhaust manifold and tube free from combustible matters. Fit the machine with shields and guards when working in the presence of combustible matter free in the air.

Do not refuel with the engine running, especially if hot, as this increases fire hazard in case of fuel spillage.

Never attempt to check or adjust fan belt tensions when the engine is running.

Do not adjust the fuel injection pump when the machine is operating.

Do not lubricate the machine with the engine running.

Do not run the engine with the air intakes open and not protected. If this cannot be avoided for service reasons, place protection meshes on all intakes before servicing the engine.

ELECTRICAL SYSTEM

Pay attention to connect connecting cables to correct poles (+ to +) and (- to -) at both ends. Do not short-circuit terminals. Thoroughly follow instructions given in Operator's manual.

Always move the key-start switch in the lock position before servicing or repairing the machine.

Batteries contain SULFURIC ACID. Protect the eyes when working near the batteries against possible sprays of the acid solution. Should acid contact skin, eyes, or clothes, RINSE IMMEDIATELY IN WATER FOR AT LEAST 15 MINUTES. Immediately seek medical attention.

Battery released gas is highly flammable. Leave the battery compartment cover open during recharging to improve ventilation. Never check battery charge by placing metal objects across the posts. Keep sparks or open flames away from batteries. Do not smoke near the battery to prevent explosion hazard.

Before any maintenance or repair, make sure that there are no fuel or electrolyte leaks from the batteries. If any, correct prior to proceeding with further work. Do not recharge batteries in confined spaces. Ensure proper ventilation is provided to avoid accidental explosions due to build-up of explosive gas released during charging.

Disconnect batteries before working on the electrical system or carrying out any other type of work.

HYDRAULIC SYSTEM

Pressure fluid escaping from a very small hole can be almost invisible and still have sufficient force to penetrate the skin. Always check any suspected pressure leaks using a piece of cardboard or wood.

Do not use hands. If injured by escaping fluid, obtain medical attention immediately or serious infection or reaction may develop.

Stop the engine and ensure pressure is relieved from all systems before removing side panels, housings, guards and covers.

Always use gauges of adequate capacity for pressure testing.

TOOLS

Always keep head, body, limbs, feet, hands, and fingers away from the bucket and attachments, when in the raised position.

Prior to any maintenance or repair work, install all supports necessary to this aim according to local and national safety regulations.

In case the attachment is to be operated for maintenance or repair purposes, do so exclusively while sitting in the driver's seat. Sound the horn before starting the machine or moving the attachment. Require that nobody remain near the machine. Raise the attachment slowly.

Do not use the machine to transport loose objects, unless proper securing devices are provided.

Never use gases other than nitrogen to charge the accumulators.

SAFETY ALERT SYMBOL

When you see this symbol on your machine or in this Manual, be alert of the potential for personal injury.

Follow recommended precautions and safe operating practices.



UNDERSTAND SIGNAL WORDS

In this Manual you will find the following words referring to different hazard risks:

- **DANGER;**
- **WARNING;**
- **CAUTION.**

These words are always accompanied by the safety alert symbol.

DANGER: indicates an imminent hazardous situation which, if not avoided, will result in death or serious injury.

WARNING: indicated a potential hazardous situation which, if not avoided, could result in death or serious injury.

CAUTION: indicates a potential hazardous situation which, if not avoided, may result in minor or moderate injury.

ATTENTION: indicates a situation which, if not avoided, may cause damage to the machine.

NOTE: indicates an additional explanation for information purposes.

ENVIRONMENTAL PROTECTION

This Manual also contains this symbol accompanying instructions for correct behaviour as regards environmental protection.

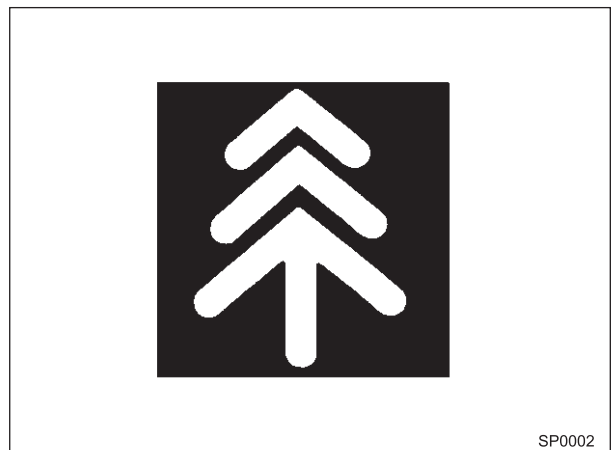



Suggest:

If the above button click is invalid.

Please download this document

first, and then click the above link

to download the complete manual.

Thank you so much for reading

FOLLOW SAFETY PRECAUTIONS

Carefully read and observe all safety decals on the machine and read all safety precautions in this Manual.

Safety decals should be installed, maintained, and replaced when necessary.

- If a safety decal or this Manual are damaged or missing, obtain a replacement from your Dealer in the same way you order a spare part (be sure to detail machine model and serial number upon ordering).

Learn how to operate the machine and its controls correctly and safely.

Allow only trained, qualified, authorised personnel to operate the machine.

Keep the machine in proper working conditions.

- Unauthorised changes to the machine may impair function and/or safety and affect machine life.

Safety messages in this Chapter are intended to illustrate basic safety procedures of the machine. However, it is impossible for these safety messages to cover every hazardous situation you may encounter. If you have any doubts, consult your direct supervisor prior to operating or servicing the machine.

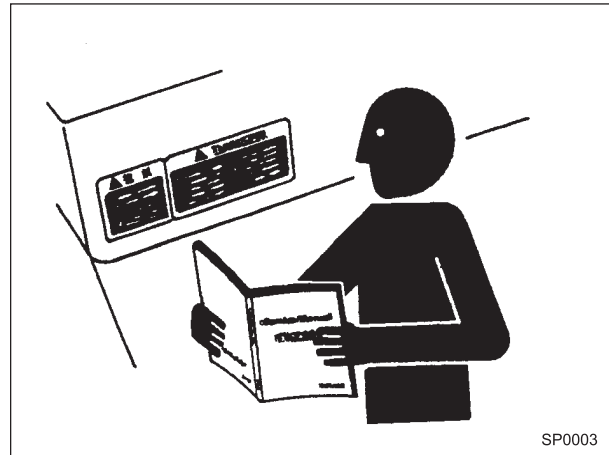

SP0003

PREPARE FOR EMERGENCIES

Be prepared if a fire starts or an accident occurs.

- Keep the first-aid kit and fire extinguisher on hand.
- Thoroughly read and understand the label attached to the fire extinguisher to use it properly.
- Establish emergency priority procedures to cope with fires and accidents.
- Keep emergency numbers for doctors, ambulance service, hospitals and fire department posted near the telephone.



SP0004

<https://www.ebooklibonline.com>

Hello dear friend!

Thank you very much for reading.

Enter the link into your browser.

The full manual is available for immediate download.

<https://www.ebooklibonline.com>