



MH City MH Plus MH 5.6

Repair
Manual

Tier III

Repair Manual

Tier III

Print No. 87677413A
English

MH City
MH Plus
MH 5.6

TO PREVENT ACCIDENTS

The majority of accidents and injuries which occur in industry, at home or on the road, are caused by the failure of some individual to follow simple and fundamental safety rules or precautions. For this reason **MOST ACCIDENTS CAN BE PREVENTED** by recognizing the real cause and taking the necessary precautions, before the accident occurs.

Regardless of the care used in design and construction of any type of equipment, there may be conditions that cannot be completely safeguarded against, without interfering with reasonable accessibility and efficient operation.

A careful operator and / or technician is the best insurance against accidents. The complete observance of one simple rule would prevent many thousands of serious injuries each year.

This rule is: never attempt to clean, lubricate or adjust a machine while it is in motion.

WARNING

Before carrying out any maintenance operation, adjustment and or repair on machines equipped with attachments, controlled hydraulically or mechanically, make sure that the attachment is lowered and safely set on the ground. If it is necessary to have the equipment partially or fully raised to gain access to certain items, be sure the equipment is suitably supported by means other than the hydraulic lift cylinders, cable and /or

SAFETY INSTRUCTION



This warning symbol points out important messages involving your safety.

Carefully read the safety rules contained herein and follow advised precautions to avoid potential hazards and to safeguard your safety and personal integrity.

In this manual you will find this symbol together with the following key-words:

WARNING

This symbol warns about the possibility of potential damages to the machine that can involve the operator's safety.

DANGER

With specific warnings about potential dangers for the operator's or other persons integrity directly or indirectly involved.

The non compliance with the warning preceded by the above mentioned key-words (**WARNING** and **DANGER**) can cause serious accidents or even the death of the persons involved.

Moreover in the present Manual have been given some instructions with texts in italics, preceded by the words **NOTE** and **CAUTION**:

NOTE: it emphasizes and underlines to the operator the correct technique or correct procedure to follow.

CAUTION

It warns the operator of a possible hazard of machine damage in case he does not follow a determined procedure.

INDEX

SECTION 01 - SAFETY PRECAUTIONS

- 1. GENERAL SAFETY INSTRUCTIONS 2
- 2. USE INSTRUCTION 11

SECTION 02 - CONTROLS AND INSTRUMENTS

- 1. SWITCHES AND PUSH-BUTTONS 1
- 2. CONTROLS AND PEDALS 6
- 3. MULTI-FUNCTION DISPLAY 10

SECTION 03 - TECHNICAL SPECIFICATIONS

- 1. MAIN COMPONENTS 1
- 2. DIMENSIONS - OPERATING WEIGHTS 3
- 3. DIGGING PERFORMANCE 19
- 4. LIFTING CAPACITIES 33
- 5. HYDRAULIC SYSTEM 39
- 6. ROTATION 40
- 7. TRAVEL 41
- 8. TYRES 42
- 9. BRAKES 42
- 10. STEERING 42
- 11. ELECTRICAL SYSTEM 42
- 12. BUCKETS 43
- 13. TIGHTENING TORQUES 44
- 14. CENTRALIZED LUBRICATION PUMP (OPTIONAL) 44
- 15. FUEL SYSTEM 44
- 16. ENGINE 45
- 17. SUPPLY SUMMARIZING CHART 46

SECTION 04 - UPPER STRUCTURE

- 1. MAIN COMPONENTS 1
- 2. SLEWING BEARING 2
- 3. ROTATION GEARMOTOR 7
 - 3.1 DISASSEMBLY AND ASSEMBLY 12
 - 3.2 SPECIAL TOOLS 34
- 4. MULTI-COOLER 35
 - 4.1 TECHNICAL SPECIFICATIONS 36
- 5. HYDRAULIC PUMPS 39
- 6. MUFFLER 40
- 7. HYDRAULIC OIL TANK 41
- 8. AIR FILTER 47
- 9. COUNTERWEIGHT 47
- 10. FUEL SYSTEM 48

<https://www.ebooklibonline.com>

Hello dear friend!

Thank you very much for reading.

Enter the link into your browser.

The full manual is available for immediate download.

<https://www.ebooklibonline.com>

11. CAB AND OPERATOR'S SEAT	55
12. CENTRALIZED LUBRICATION PUMP.....	66

SECTION 05 - UNDERCARRIAGE

1. UNDERCARRIAGE COMPONENTS.....	1
2. REAR RIGID AXLE.....	2
2.1 TECHNICAL SPECIFICATIONS.....	3
2.2 DISASSEMBLY AND ASSEMBLY.....	6
2.3 DISASSEMBLY AND ASSEMBLY.....	8
2.4 TROUBLESHOOTING.....	87
2.5 SPECIAL TOOLS.....	89
3. TRAVEL MOTOR.....	90
3.1 TECHNICAL SPECIFICATIONS.....	90
3.2 DISASSEMBLY AND ASSEMBLY.....	91
3.3 DISASSEMBLY AND ASSEMBLY.....	92
4. CARDAN SHAFT	103
4.1 DISASSEMBLY AND ASSEMBLY.....	104
5. FRONT STEERING AXLE	106
5.1 TECHNICAL SPECIFICATIONS.....	107
5.2 DISASSEMBLY AND ASSEMBLY.....	110
5.3 DISASSEMBLY AND ASSEMBLY.....	112
5.4 TROUBLESHOOTING.....	185
5.5 SPECIAL TOOLS.....	187
6. WHEELS AND TYRES	188
7. BLADE	192
7.1 BLADE CYLINDER.....	194
8. AXLE FLOATING LOCKING CYLINDERS	202
8.1 TECHNICAL SPECIFICATIONS.....	203
8.2 DISASSEMBLY AND ASSEMBLY.....	204
8.3 AIR BLEEDING.....	205
8.4 DISASSEMBLY AND ASSEMBLY.....	206
8.5 TROUBLESHOOTING.....	208
9. STABILIZERS	209
9.1 STABILIZER CYLINDERS.....	212
9.2 TROUBLESHOOTING.....	221
10. LEFT LADDER.....	223
11. RIGHT LADDER AND TOOL STORAGE BOX.....	224
12. ROTARY CONTROL VALVE AND ELECTRIC ROTOR.....	225
12.1 TECHNICAL SPECIFICATIONS.....	225
12.2 DISASSEMBLY AND ASSEMBLY.....	226
12.3 DISASSEMBLY AND ASSEMBLY.....	227
12.4 ELECTRIC ROTOR	229

SECTION 06 - FRONT ATTACHMENT

1. TYPES OF FRONT ATTACHMENT	2
2. HYDRAULIC CYLINDERS.....	4
2.1 BOOM CYLINDER.....	5
2.2 SPECIAL TOOLS.....	50

3. BUCKETS.....	51
4. QUICK COUPLER.....	55
5. CLAMSHELL BUCKET.....	59

SECTION 07 - STEERING SYSTEM

1. OPERATION.....	1
2. POWER STEERING.....	3
2.1 DISASSEMBLY AND ASSEMBLY.....	5
3. PRIORITY VALVE.....	23
4. TROUBLESHOOTING.....	24

SECTION 08 - BRAKE SYSTEM

1. OPERATION.....	1
2. SERVICE BRAKE.....	4
3. PARKING BRAKE.....	7
4. PEDAL BRAKE VALVE.....	8
5. ACCUMULATORS.....	9
6. TROUBLESHOOTING.....	11

SECTION 09 - HYDRAULIC SYSTEM

1. HYDRAULIC SYSTEM.....	1
2. HYDRAULIC SYSTEM DIAGRAMS.....	5
2.1 HYDRAULIC SYSTEM DIAGRAMS - UPPER STRUCTURE.....	5
2.2 HYDRAULIC SYSTEM DIAGRAMS - UNDERCARRIAGE.....	23
2.3 HYDRAULIC SYSTEM DIAGRAMS BLADE AND/OR STABILIZERS.....	27
3. HYDRAULIC PUMPS.....	31
4. UPPER STRUCTURE CONTROL VALVE.....	48
5. UNDERCARRIAGE CONTROL VALVE.....	58
6. PILOT CONTROL ASSY.....	60
7. ROTATION SYSTEM.....	69
8. TRAVEL.....	73
9. STABILIZATION HYDRAULIC SYSTEM.....	84
10. BOOM HYDRAULIC SYSTEM.....	90
11. HYDRAULIC SYSTEM.....	97
12. HYDRAULIC SYSTEM OF DIPPER.....	103
13. HYDRAULIC SYSTEM OF PLACING BOOM.....	107
14. HYDRAULIC SYSTEM WITH COMBINATION OF DIFFERENT FUNCTIONS (BOOM, PLACING BOOM, DIPPER AND BUCKET).....	114
15. HYDRAULIC SYSTEM OF HAMMER (WITH PLACING BOOM).....	116
16. HYDRAULIC SYSTEM OF HAMMER AND SHEARS (WITH PLACING BOOM).....	119
17. HYDRAULIC SYSTEM OF SHEARS (WITH PLACING BOOM).....	124
18. HYDRAULIC SYSTEM OF HAMMER (WITH MONOBOOM).....	127
19. HYDRAULIC SYSTEM OF HAMMER AND SHEARS (WITH MONOBOOM).....	130
20. HYDRAULIC SYSTEM OF SHEARS (WITH MONOBOOM).....	135
21. TROUBLESHOOTING.....	138

SECTION 10 - ELECTRICAL SYSTEM

1. ELECTRICAL DIAGRAMS.....	1
2. FUSES	41
3. BATTERIES	44
4. BULBS	48
5. TROUBLESHOOTING.....	52

SECTION 11 - ELECTRONICS

1. MAIN COMPONENTS	1
1.1 ELECTRICAL POWER SUPPLY DIAGRAM	3
2. COMPONENTS OF LINE 1	5
3. COMPONENTS OF LINE 2	9
3.1 TRAVEL PEDAL	15
3.2 ATTACHMENT PEDAL (PLACING BOOM AND HAMMER).....	16
3.3 ELECTRO-HYDRAULIC SYSTEM	17
3.4 POWER CONTROL SYSTEM	18
4. ENGINE SPEED ACTUATOR	25
5. COOLANT TEMPERATURE DETECTION.....	26
6. CHARGE AIR TEMPERATURE DETECTION.....	27
7. HYDRAULIC OIL TEMPERATURE DETECTION.....	28
8. PROPORTIONAL VALVE - FAN MOTOR	29
9. PROPORTIONAL VALVES - CONTROL BLOCK.....	30

SECTION 12 - CALIBRATION

1. NECESSARY OPERATIONS BEFORE CALIBRATION.....	1
2. DISPLAY: CALIBRATION MENU	3
3. CALIBRATIONS WITH THE ENGINE RUNNING.....	4
3.1 VDO CALIBRATION	6
3.2 POWER CALIBRATION	8
3.3 MAIN VALVE CALIBRATION (CONTROL VALVE).....	10
3.4 TRAVEL CALIBRATION	13
3.5 PUMP DELIVERY CALIBRATION.....	15
3.6 ROTATION PUMP CALIBRATION.....	18
3.7 AUXILIARY PRESSURE CALIBRATION	20
4. CALIBRATIONS WITH THE ENGINE STOPPED	22
4.1 CALIBRATIONS, ALL SOLENOID VALVES, MAIN PUMP, ROTATION PUMP, AUXILIARY PRESSURE ²⁴	
4.2 MAIN VALVE CALIBRATION (CONTROL VALVE).....	26
5. DISTRIBUTORE	26
6. VALVOLA SOSTENIMENTO DEL CARICO	29
7. DIAGNOSI INCONVENIENTI	30

SECTION 01 - SAFETY PRECAUTIONS

1. GENERAL SAFETY INSTRUCTIONS.....	2
2. USE INSTRUCTION	11

Carefully read the safety rules contained herein and follow advised precautions to avoid potential hazards and to safeguard your safety and personal integrity.

In this manual you will find the following indications:

⚠ WARNING

This symbol warns about the possibility of potential damages to the machine that can involve the operator's safety.

⚠ DANGER

With specific warnings about potential dangers for the operator's or other persons integrity directly or indirectly involved.

The non compliance with the warning preceded by the above mentioned key-words (**WARNING** and **DANGER**) can cause serious accidents or even the death of the persons involved.

Moreover in the present Manual have been given some instructions with texts in italics, preceded by the words **NOTE** and **CAUTION**, with following meanings for machine protection:

NOTE: it emphasizes and underlines to the operator the correct technique or correct procedure to follow.

⚠ WARNING

It warns the operator of a possible hazard of machine damage in case he does not follow a determined procedure.

Your safety and that of people around you depends on you. It is essential that you understand this manual for the correct operation, inspection, lubrication and maintenance of this machine.



1. GENERAL SAFETY INSTRUCTIONS

Carefully read this Manual before proceeding with maintenance, repairs, refuelling or other machine operations.

Repairs have to be carried out only by authorized and instructed staff; specific precautions have to be taken when grinding, welding or when using mallets or heavy hammers.

Not authorized persons are not allowed to repair or carry out maintenance on this machine. Do not carry out any work on the equipment without prior authorization.

Ask your employer about the safety instructions in force and safety equipment.

Nobody is allowed to seat on the operator's place during machine maintenance unless he is a qualified operator helping with the maintenance work.

If it is necessary to move the equipment to carry out repairs or maintenance, do not lift or lower the equipment from any other position than the operator's seat.

Never carry out any operation on the machine when the engine is running, except when specifically indicated.

Stop the engine and ensure that all pressure is relieved from hydraulic circuits before removing caps, covers, valves, etc.

All repair and maintenance operations should be carried out with the greatest care and attention.

Service stairs and platforms used in a workshop or in the field should be built in compliance with the safety rules in force.

Any functional disorders, especially those affecting the safety of the machine, should therefore be rectified immediately.

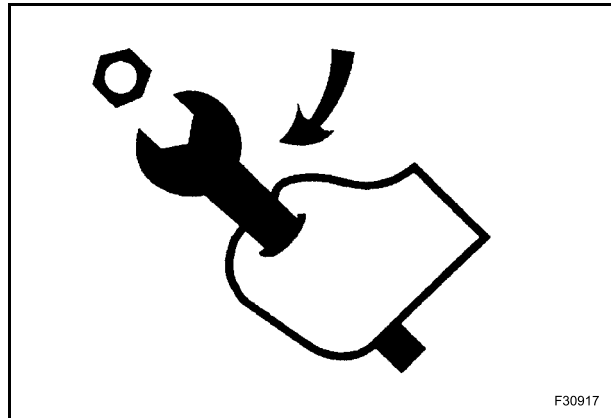

1.1 EMERGENCY

Be prepared for emergencies. Always keep at disposal on the machine a first aid kit and a fire extinguisher. Make sure that the fire extinguisher is serviced in accordance with the manufacturer's instructions.

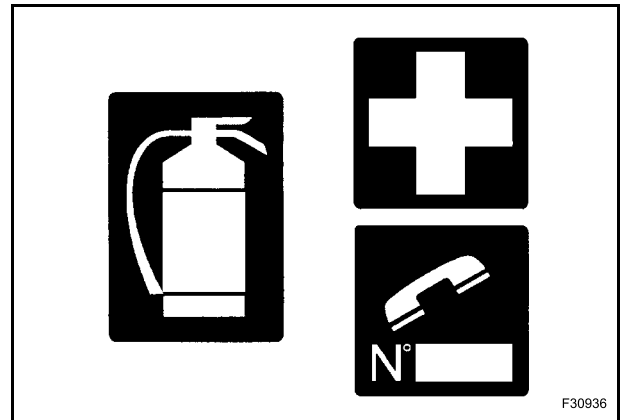

1.2 EQUIPMENT

Wear close fitting clothing and safety equipment appropriate for the job:

- safety helmet;
- safety shoes;
- heavy gloves;
- reflective clothing;
- wet weather clothing.

If environment condition require it following personal safety equipment should be at hand:

- respirators (or dustproof masks);
- ear plugs or acoustic ears protections;
- goggles with lateral shield or masks for eyes protection.

Do not wear rings, wristwatches, jewels, unbuttoned or flapping clothing such as ties, torn clothes, scarves, open jackets or shirts with open zips which could get caught into moving parts.

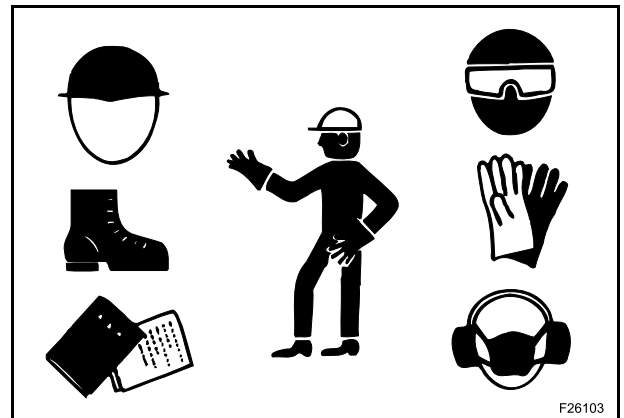

1.3 ENGINE - RADIATOR

Never leave the engine run in closed spaces without ventilation and not able to evacuate toxic exhaust gases. Keep the exhaust manifold and tube free from combustion materials.

Do not refuel with the engine running, especially if hot, as this increases fire hazard in case of fuel spillage.

Never attempt to check or adjust the fan belts when the engine is running.

Never lubricate the machine with the engine running.

Pay attention to rotary pieces and do not allow to anyone to approach to avoid becoming entangled.

If hands, clothes or tools get caught in the fan blades or in the transmission belt, this can cause amputations, violent tears and generate condition of serious danger; for this reason avoid touching or to come close to all rotary or moving parts.

A violent jet of the coolant from the radiator can cause damages and scalds.

If you are to check the coolant level, you have to shut off the engine previously and to let cool down the radiator and its pipes. Slowly unscrew the cap to release the inside pressure.

If necessary, remove the cap with hot engine, wear safety clothes and equipment, then loosen the cap slowly to relieve the pressure gradually.

When checking the fuel, oil and coolant levels, use exclusively explosion proof classified lamps. If this kind of lamps are not used fires or explosions may occur.

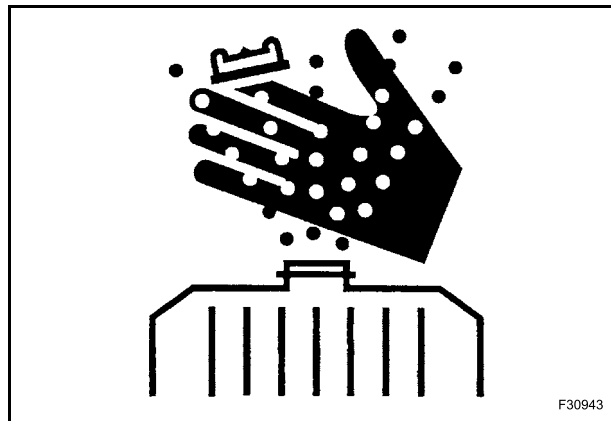
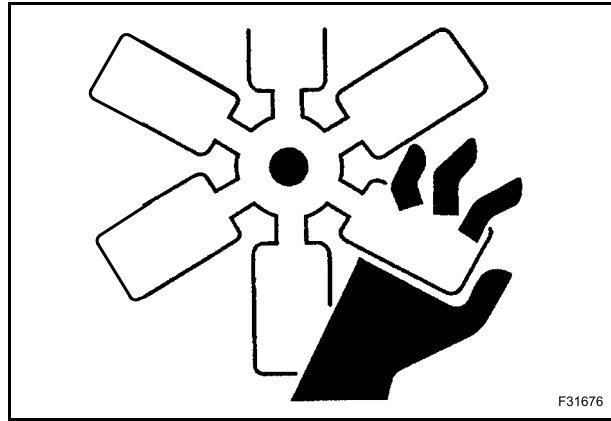

1.4 HYDRAULIC SYSTEMS

Splashes of fluids under pressure can penetrate the skin causing serious injuries.

Avoid this hazard by relieving pressure before disconnecting hydraulic or other lines.

Relieve the residual pressure by moving the hydraulic control levers several times.

Tighten all connections before applying pressure.

To protect the eyes wear a facial shield or safety goggles.

Protect your hands and body from possible splashes of fluids under pressure.

Swallowing hydraulic oil is a severe health hazard.

When hydraulic oil has been swallowed, avoid vomiting, but consult a doctor or go to a hospital.

If an accident occurs, see a doctor familiar with this type of injury immediately.

Any fluid penetrating the skin must be removed within few hours to avoid serious infections.

Flammable splashes may originate because of the heat near pipes with fluids under pressure, with the result of serious scalds for the persons hit. Do not weld or use torches near pipes containing fluids or other flammable materials.

Pipes under pressure can accidentally be pierced when the heat expands beyond the area immediately heated.

Arrange for fire resistant temporary shields to protect hoses or other components during welding.

Have any visible leakage repaired immediately.

Escaping oil pollutes the environment. Soak up any oil that has escaped with a proper binding agent.

Sweep up binding agent and dispose of it separately from other waste.

Never search for leakages with the fingers, but use a piece of cardboard and always wear goggles.

Never repair damaged piping; always replace it. Replace hydraulic hoses immediately on detecting any damage or moist areas.

Always store hydraulic oil in the original containers.

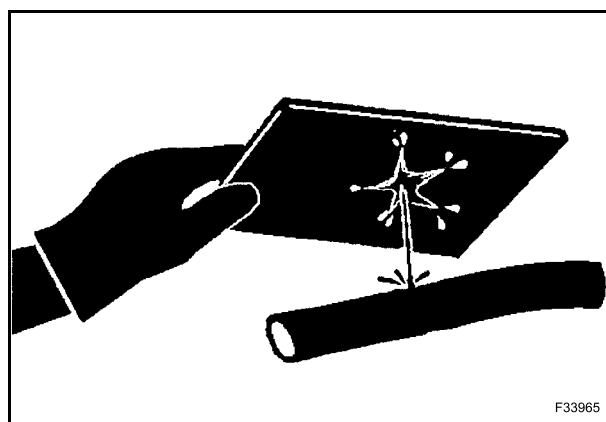

HOSES AND TUBES

Always replace hoses and tubes if the cone end or the end connections on the hose are damaged.

When installing a new hose, loosely connect each end and make sure the hose takes up the correct position before tightening the connections. Clamps should be tightened sufficiently to hold the hose without crushing and to prevent chafing.

After hose replacement to a moving component, check that the hose does not foul by moving the component through the complete range of travel.

Be sure any hose which has been installed is not kinked or twisted.

Hose connections which are damaged, dented, crushed or leaking, restrict oil flow and the productivity of the components being served. Connectors which show signs of movement from the original position have failed and will ultimately separate completely.

A hose with a frayed outer sheath will allow the water penetration. Concealed corrosion of the wire reinforcement will subsequently occur along the hose length with resultant hose failure.

Ballooning of the hose indicates an internal leakage due to structural failure. This condition rapidly deteriorates and total hose failure soon occurs.

Kinked, crushed, stretched or deformed hoses generally suffer internal structural damage which can result in oil restriction, a reduction in the speed of operation and ultimate hose failure.

Free-moving, unsupported hoses must never be allowed to touch each other or related working surfaces. This causes chafing which reduces hose life.

O-RINGS

Replace O-rings, seal rings and gaskets whenever they are disassembled.

Never mix new and old seals or O-rings, regardless of condition. Always lubricate new seal rings and O-rings with hydraulic oil before installation to relevant seats.

This will prevent the O-rings from rolling over and twisting during mounting which will jeopardize sealing.

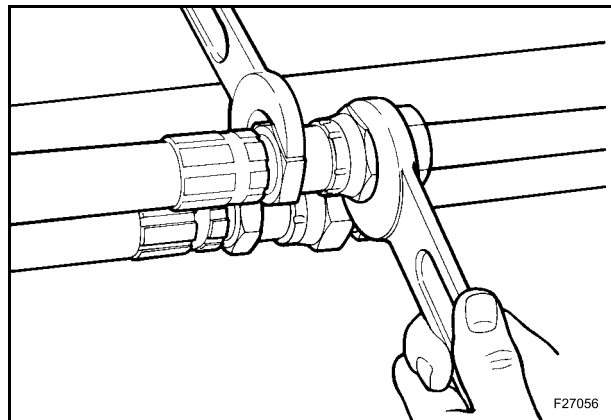

1.5 BATTERY

Batteries give off explosive gases.

Never handle naked flames and unshielded light sources near batteries, never smoke.

To prevent any risk of explosion, observe the following instructions:

- when disconnecting the battery cables, always disconnect the negative (-) cable first;
- to reconnect the battery cables, always connect the negative (-) cable last;
- never short-circuit the battery terminals with metal objects;
- do not weld, grind or smoke near a battery.

Battery electrolyte causes severe burns. The battery contains sulphuric acid. Avoid any contact with the skin, eyes or clothing.

Antidote:

- **EXTERNAL:** rinse well with water, removing any soiled clothing.
- **INTERNAL:** avoid vomiting. Drink water to rinse your mouth. Consult a doctor.
- **EYES:** rinse abundantly with water for 15 minutes and consult a doctor.
- When the electrolyte of a battery is frozen, it can explode if you attempt to charge the battery or if you try to start the engine using a booster battery. Always keep the battery charged to prevent the electrolyte freezing.

Provide good ventilation when changing a battery or using a battery in an enclosed space. Always protect your eyes when working near a battery.

Never set tools down on the battery. They may induce a short circuit, causing irreparable damage to the battery and injuring persons.

Never wear metal necklaces, bracelets or watch-straps when working on the battery. The metal parts may induce a short circuit resulting in burns.

Dispose of used batteries separately from other waste in the interests of environmental protection.

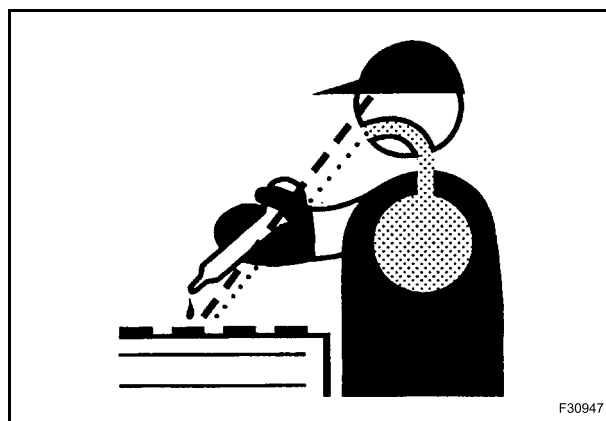
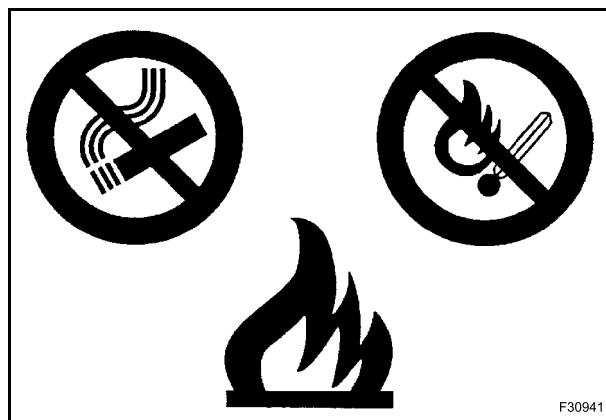
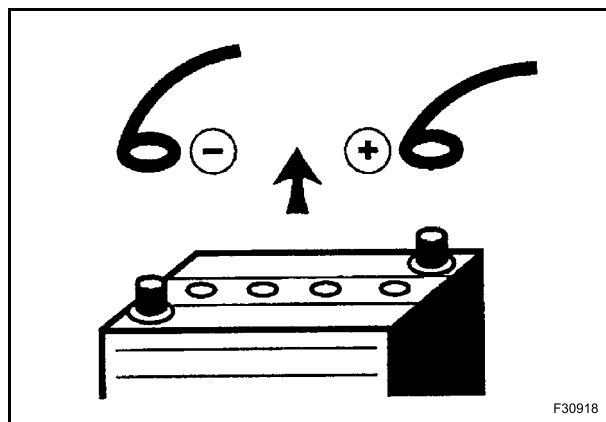

1.6 FLAMMABLE LIQUIDS

When handling flammable liquids:

- do not smoke;
- keep away from unshielded light sources and naked flames.

Fuels often have a low flash point and are readily ignited.

Never attempt to extinguish burning liquids with water. Use:

- dry powder;
- with carbon dioxide;
- with foam.

Water used for extinguishing purposes would vaporize instantaneously on contact with burning substances and spread burning oil, for example, over a wide area. Water generates short circuits in the electrical system, possibly producing new hazards.

Stay away from open flames during refilling of hydraulic oil or fuel.

Fuel or oil splashes can cause slipping and therefore accidents; clean immediately and accurately the areas eventually smeared.

Always tighten the safety plugs of fuel tank and hydraulic oil tank firmly.

Never use fuel to clean the machine parts eventually smeared with oil or dust.

Use a non-inflammable product for cleaning parts.

Always perform fuel or oil refilling in well aired and ventilated areas.

During refuelling hold the pistol firmly and keep it always in contact with the filler neck until the end of the refuelling, to avoid sparkles due to static electricity.

Do not overfill the tank but leave a space for fuel expansion.

Never re-fuel when the engine is running.

Take all the necessary safety measures when welding, grinding or when working near a naked flame.

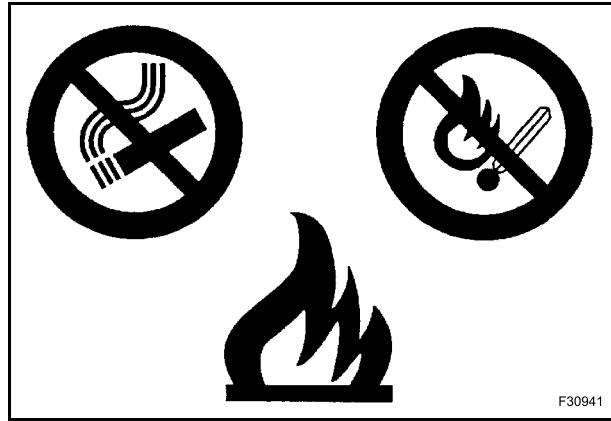

F30941



F31677



F33951



Suggest:

If the above button click is invalid.

Please download this document

first, and then click the above link

to download the complete manual.

Thank you so much for reading

1.7 TYRES

Before inflating the tyres, always check the condition of rims and the outer condition of tyres to find out the presence of dents, cuts, tears or reinforcement plies or other faults. Before inflating a tyre, make sure that there are no nearby persons, then position yourself at tread side.

Make sure that the inflating pressure of tyres is the same prescribed by manufacturer and that the pressure of the right tyre corresponds to the pressure of the left tyre.

Never use reconditioned rims because possible welds, heat treatments or brazings not performed correctly can weaken the wheels and cause following damages or failures. Deflate the tyres before their disassembly.

Before taking out possible jammed objects from the rims, it is necessary to deflate the tyres. Inflate tyres by means of a pistol complete with extension and pressure switch of control.

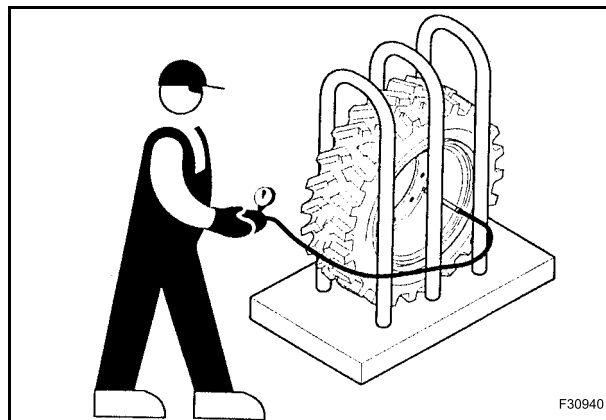

1.8 CLEANING

Clean the exterior of all components before carrying out any form of repair. Dirt and dust can reduce the efficient working life of a component and lead to costly replacement.

Solvents should be checked that they are suitable for the cleaning of components and also that they do not risk the personal safety of the user.

Dirt from oil or grease and scattered tools or faulty pieces are dangerous for persons, because they can generate slipping or falls.

For the machine cleaning, use a jet of warm water or steam under pressure and commercial detergents. Never use fuel, petroleum or solvents, because the first ones leave an oily layer that favours the sticking of dust, while solvents (even if weak) damage the paint and favour the formation of rust.

Never use water jets or steam on sensors, connectors or other electric components.

Prevent that the water jet penetrates inside the cab.

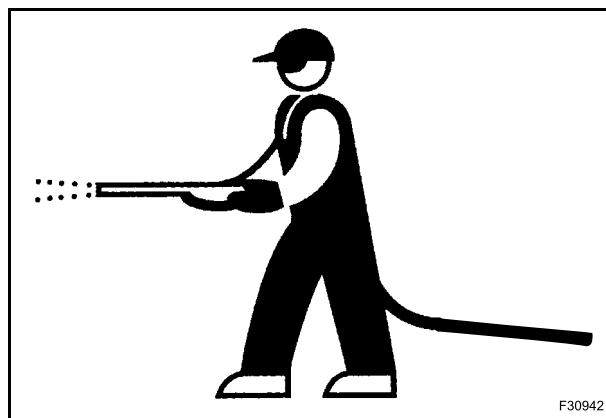

<https://www.ebooklibonline.com>

Hello dear friend!

Thank you very much for reading.

Enter the link into your browser.

The full manual is available for immediate download.

<https://www.ebooklibonline.com>