

MH City

MH Plus

MH 5.6

HYDRAULIC EXCAVATOR

Workshop Manual

Print No. 604.13.557 English
III-2005



THIS ALERT SYMBOL SIGNALS IMPORTANT MESSAGES INVOLVING YOUR SAFETY.

Read and heed carefully the safety instructions listed and follow the precautions recommended to avoid potential risks and to safeguard your health and your safety.

You will find this symbol in the text of this Manual referred to the following key words:

WARNING - Cautions directed to avoid improper repair interventions involving potential consequences for the safety of the personnel performing the repairs.

DANGER - These warnings qualify specifically potential dangers for the safety of the operator or other persons directly or indirectly involved.

IMPORTANT NOTICE

All maintenance and repair interventions explained in this Manual **must be performed exclusively by the Service Organisation of the Manufacturer**, observing strictly the instructions explained using, whenever necessary, the recommended specific tools.

Whoever performs the operations reported without following exactly the precautions is responsible on his own, for the damages that may result.

Neither the Factory nor any Organisations in its Distribution Network, including but not limited to national, regional or local distributors, are responsible for any liability arising from any damage resulting from defects caused by parts and/or components not approved by the Factory for use in maintaining and/or repairing products manufactured or merchandised by the Factory.

In any case, no warranty of any kind is made or shall be imposed with respect to products manufactured or merchandised by the Factory, when failures are caused by the use of parts and/or components not approved by the Factory.

AVOID ACCIDENTS

Most accidents, whether they occur in industry, on the farm, at home or on the road, are caused by the failure of some individuals to follow simple and fundamental safety rules and precautions. For this reason **MOST ACCIDENTS CAN BE PREVENTED** by recognising the real cause and doing something about it before the accident occurs.

Regardless of the care used in the design and construction of any type of equipment, there are many conditions that cannot be completely safeguarded against without interfering in the reasonable accessibility and efficient operation.

A careful operator is the best insurance against an accident. The complete observance of one simple rule would prevent many serious accidents.

The rule is simple: never attempt to clean, lubricate or maintain a machine while it is in motion.



WARNING

Prior to engaging in any maintenance, adjustment or repair operation on machines having hydraulically, mechanically, and/or cable controlled equipment (such as shovels, loaders, dozers, excavators etc.) be certain the equipment is lowered to the ground.

If it is necessary to have the equipment partially or fully raised to gain access to certain items, be sure the equipment is suitably supported by means other than the devices used for controlling the equipment.

PREFACE

To the reader

This Workshop Manual is written for the **Repair-Technician**. It provides important information on how to perform skilful repairs.

We recommend to consult the **Workshop Manual** and also the Hydraulic Excavator Operation and Maintenance Instruction Manual before initiating any repair-work operation. Utilize the **Workshop Manual** as well as the **Operation and Maintenance Instruction Manual** and the **Parts Catalog** as a prompt-book and adviser, even if the Hydraulic Excavator technique is become familiar. By means of the Workshop Manual the expert technician will be able to carry out a skilful repair-work operation.

Use

The Workshop Manual refers to the initial Machine configuration. Structural changes or rebuilding operations are not described in this Handbook. In this Workshop Manual the following information can be found:

- Safety Instructions;
- Technical Data and Special Tools;
- Functional Description;
- Performance Testing;
- Troubleshooting and Failure Correction;
- Repair Instructions.

In the Section **Safety Instructions** the recommended procedures are described, so that through the relevant compliance with, a risk of accident for the User and for the personnel responsible of the maintenance operations on the machine can be avoided.

In the Section **Technical Data** the Service Data, the change tables and lists of the needed Special Tools and Maintenance materials are indicated.

In other Sections, for each mechanical group, when available can be found:

- a functional description with information concerning the operation of the essential devices and equipments;

- information for carrying out the performance tests on the machine;
- troubleshooting, information concerning the recognition and correction of failures on the machine,
- technical information necessary for carrying out the Service and Repair operations on the Machine, the equipment necessary for the maintenance operations, the information concerning the Standards to be applied in the Maintenance operations, the Procedures for the Removal and Installation operations as well as for Disassembly and Assembly operations.

By means of the index contents a desired information can be easily achieved.

For a better understanding the illustration of the part will be displayed.

Therefore differences in arrangement of the Hydraulic Excavator are possible, whenever the latter involves the univocal capability of the information.

REPAIR OPERATIONS

Carry out the necessary repair works as soon as possible. This procedure will avoid the maintenance costs while increasing the availability of your Hydraulic Excavator.

Pay always attention during all works to the Workshop Manual warnings and cautions and to the Operation and Maintenance Instruction Manual.

The Service Assistance will gladly carry out for you the works not described in the Workshop Manual.

Always utilize the **Original Spare Parts** only.

FURTHER INFORMATION MATERIAL

Please notice the supplementary information consulting the following Handbooks:

- **Operation and Maintenance Instruction Manual;**
- **Parts Catalog.**

Warnings and symbols

The following signs are used in the Workshop Manual to designate exceptionally important information:



Precautionary rules and measures designed to protect the operator and other persons from life-threatening hazards or injury and to prevent extensive damage to property.



Information and precautionary measures designed to prevent damage to the machine and other property.

Risks resulting from failure to observe the safety instructions



This hydraulic excavator has been built in accordance with state-of-the-art standards and recognized safety regulations.

Nevertheless, its use may constitute a risk if it continues to be operated despite damage being suspected or having occurred, or if it is inexpertly repaired.

There is then a risk of

- life-threatening injury
- irreparable damage to the machine and other assets.

The hydraulic excavator must be stopped immediately if suspected damage or damage that has occurred affects the safety of the operator, other persons at the excavator deployment site, or other assets. All components are carefully coordinated. Trouble-free operation and a long service life are assured only if original spare parts are used.

<https://www.ebooklibonline.com>

Hello dear friend!

Thank you very much for reading.

Enter the link into your browser.

The full manual is available for immediate download.

<https://www.ebooklibonline.com>

SUMMARY

SAFETY INSTRUCTIONS	SECT. 0
TECHNICAL DATA AND SPECIAL TOOLS	SECT. 1
MACHINE STRUCTURE	SECT. 2
ELECTRICAL SYSTEM	SECT. 3
ELECTRONICS	SECT. 4
HYDRAULICS	SECT. 5
CALIBRATION	SECT. 6
TROUBLESHOOTING	SECT. 7
REPAIR INSTRUCTIONS	SECT. 8

SECTION 0
SAFETY INSTRUCTION

INDEX

Page

SAFETY INSTRUCTIONS	0-1
Personal safety instructions	0-1
Observe the safety instructions.....	0-1
Protection from noise	0-1
Preparing for emergencies.....	0-1
Wearing protective clothing.....	0-2
Safety instructions before starting work	0-3
Checking the machine.....	0-3
Keeping the working area clean.....	0-3
Using grab handles and steps	0-4
Adjusting the operator's seat	0-4
Applying the safety belt.....	0-5
Working from the operator's seat only	0-5
Never take passengers on the machine	0-5
Safety instructions for machine operation	0-6
Before setting off	0-6
Note the position of the working equipment.....	0-6
Taking care during operation	0-6
Taking care when trenching.....	0-7
Distance from overhead power lines	0-7
Accident Prevention when reversing and slewing	0-8
Rules for driving on the road.....	0-9
Recovering and towing the machine.....	0-9
Travelling uphill and downhill	0-10
Preventing the machine from overturning	0-11
Inspecting the deployment location.....	0-11
Parking the machine safely.....	0-12
Preventing accidents when the machine is moving	0-12
Confirming the direction of machine travel.....	0-12
Avoid caving out high banks	0-13
Protection from rockfall and landslides	0-13
Caving prevention	0-14
Never move the bucket above persons	0-14
Safety instructions, maintenance/servicing	0-15
Safety during transport.....	0-15
Safety during servicing operations.....	0-16
Warning instructions for servicing work	0-17
Correct machine support.....	0-17
Working at greater heights.....	0-18
Keeping clear of moving parts	0-18
Prestressed units	0-19
Never remove lead seals	0-19

Safety instructions for accumulators	0-19
Dismantling components	0-20
After repair work	0-20
Correct waste disposal	0-20
Welding operations	0-21
Starting the engine with starter batteries	0-22
Prevention of acid-induced burns	0-22
Prevention of scalding	0-23
Safe handling of fluids	0-23
Fire prevention	0-24
Evacuation in case of fire	0-25
Risks from exhaust gases	0-25
Risks from fluids in pressure systems	0-26
Preventing heat build-up close to pressure systems	0-27
Preventing heat build-up in lines carrying combustible fluids	0-27
Removing paint before welding	0-28
Risks from breaking-away components	0-29
Use appropriate tools	0-29
Warning and instruction signs	0-30
Signs	0-30
Positioning of signs	0-31
Organizational measures	0-32
Selection and qualification of personnel; basic responsibilities	0-33
Safety instructions governing specific operational phases	0-33
Warning of special dangers	0-35

SAFETY INSTRUCTIONS

Personal safety instructions

Observe the safety instructions



- Read carefully through all safety instructions attached to the machine and observe them; read all safety instructions in this manual in addition.
- Safety instruction stickers/plates must be affixed, maintained and replaced when necessary.
- If a safety instruction sticker/plate or this manual is damaged or missing, obtain a replacement from your dealer. The procedure is the same as when ordering spare parts (it is essential to quote the machine type and the serial number).
- Familiarize yourself with the correct, safety-oriented procedure for operating the machine and its control elements.
- Allow only trained, qualified and authorized persons to operate the machine.
- Keep the machine in good working order.
- Unauthorized modifications to the machine may affect its efficiency and/or safety and reduce its service life.
- The instructions given in this Safety Instructions section are designed to show the fundamental safety procedures for the machine. However, they cannot cover all hazardous situations with which you may be confronted. If in doubt, consult your immediate superior before operating the machine or carrying out servicing work.

Protection from noise



- Sustained effects of noise may lead to impaired hearing or deafness.
- Wear appropriate ear protectors such as earplugs or muffs for protection from disturbing or intolerable noise.

Preparing for emergencies



- Be prepared for the event of a fire breaking out or an accident occurring.
- Keep the first-aid box and the fire extinguisher readily accessible at all times.
- Read the instructions for operating the fire extinguisher and learn how to use it properly.
- Stipulate emergency procedures for the event of fire or accidents.
- Keep the emergency numbers of doctors, emergency services, hospitals and the fire service in the immediate vicinity of the phone.

Wearing protective clothing



Wear close-fitting clothing and protective equipment suited to the work.

You need:

- a safety helmet
- safety footwear
- goggles or face guard
- protective gloves
- ear protectors
- reflective clothing
- waterproof clothing
- respirator or filtering mask.

Ensure that you wear the right equipment and clothing for the job.

- Never take risks.
- Never wear loosely fitting clothing, jewellery or other objects that might get caught on operating levers or other machine components.

Safe operation demands the operator's complete attention. Never wear headphones to listen to the radio or to music while operating the machine.

Safety instructions before starting work

Checking the machine



Before starting up the machine each day or before each shift, give the outside of the machine a careful visual inspection to prevent damage and injury.

- Check the machine for superficial damage.
- Check before starting work that all covers and caps are closed and locked.



Fig. 1

Keeping the working area clean



Clean the working area before starting work.

- Remove any objects that might endanger the mechanics or persons in the working area.
- Keep your cab clean and cleared; loose items may disturb the machine operation.

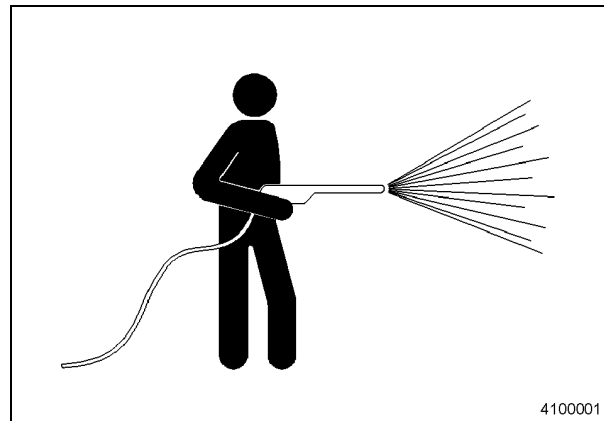



Fig. 2

Using grab handles and steps



Falls are one of the main causes of injury.

- Always face the machine when entering or leaving it, and use only the aids provided, e.g. steps and handrails.
- Never use operating elements as grab handles.
- Never jump down from the machine.
- Never climb up onto or down from a moving machine.
- Watch for slippery platforms, steps and handles when leaving the machine.

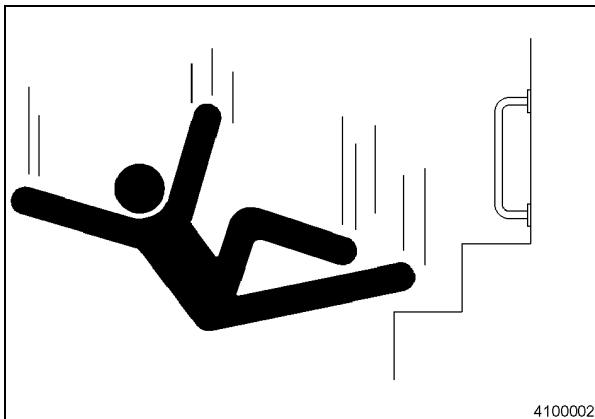



Fig. 3

Adjusting the operator's seat



A seat that is poorly adjusted with respect to the operator or the working conditions may result in premature operator fatigue and thus in faulty operation.

- The seat must be adjusted with any change of machine operator.
- The operator must be able to depress the pedals completely and move the control levers effortlessly with his back resting against the backrest.

If that is not possible, move the seat forward or back and check the setting again.

Consult the relevant section in the Owner's Manual.

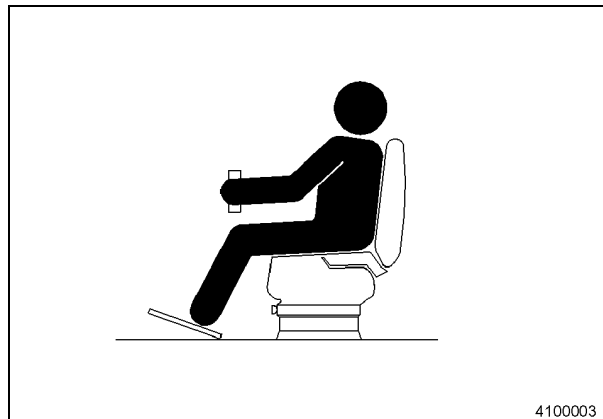

Fig. 4

Applying the safety belt



If the machine overturns, the operator may be injured and/or thrown out of the cab. He may be severely injured or even crushed to death by the overturning machine.

- Before operating the machine, check the belt fabric, the closure and the fastening components carefully. If one of the parts is damaged or worn, replace the safety belt or the components before starting up the machine.
- Always remain seated and keep the safety belt fastened while operating the machine. This will help minimize the risk of injury in the event of an accident.

The safety belt must be replaced after any serious accident even if it appears to be undamaged.

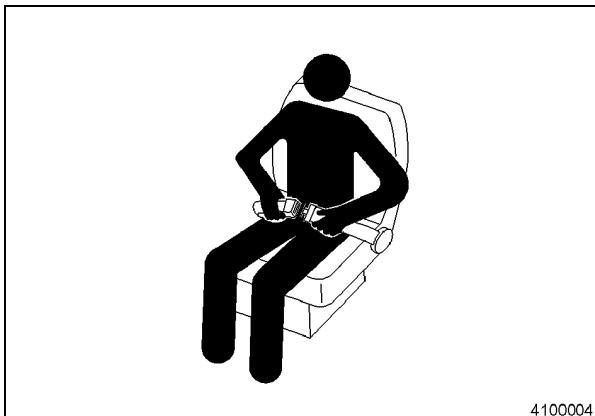

4100004

Fig. 5

Working from the operator's seat only



Starting up the engine incorrectly may cause the machine to make unexpected movements that might lead to severe, even fatal, injury.

- Always start up the engine from the operator's seat only.
- Never start the engine by short-circuiting the starter.
- After starting up the engine, check that all driving levers, driving pedals and control levers are in neutral position.

Never take passengers on the machine



Passengers on the machine may suffer injury e.g. from foreign bodies or through being thrown off.

- Only the operator is allowed onto the machine. Never take passengers.
- Passengers also obstruct the operator's view so that the machine is no longer safely operated.

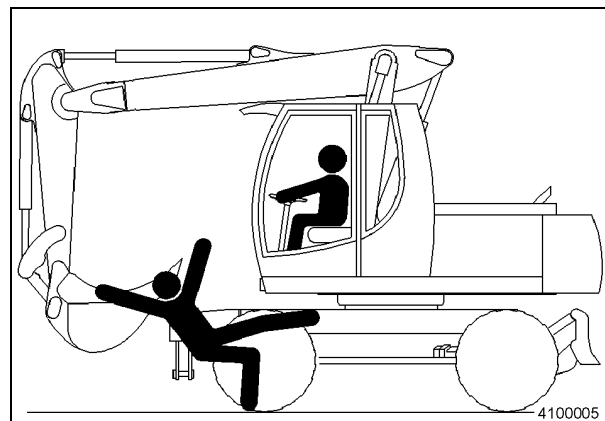

4100005

Fig. 6

Safety instructions for machine operation

Before setting off



Remove any soil, mud, snow, ice, grease and oil from your working footwear before operating the machine. You might otherwise slip from steps and pedals and thus initiate inadvertent movements.

Adjust the driver's seat and the mirror before setting off.

Close the front window and the cab door.

If the machine is equipped with a restraining belt for the operator, fasten the belt.

Before setting off, sound the horn to warn any persons in the immediate vicinity.

Never allow other persons to travel with you on the machine.

Note the position of the working equipment



Never drive with the working equipment extended, as that may impair the stability of the machine. Bring the working equipment as close as possible to the machine.

Taking care during operation



If the front equipment or another part of the machine collides with a higher obstacle, e.g. a bridge, both the machine and the other object are damaged, and persons may be injured.

Take care to prevent the boom or stick from colliding with higher obstacles.

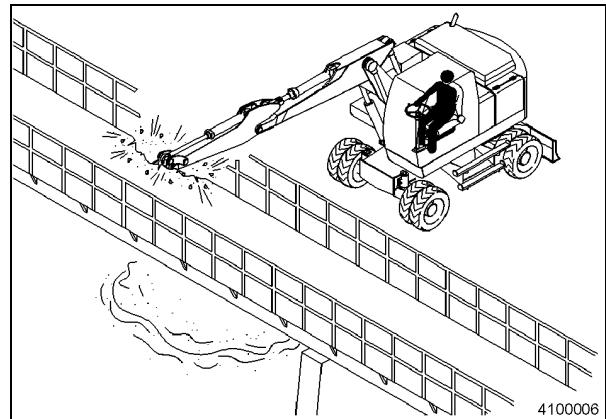

Fig. 7

Taking care when trenching



The inadvertent severing of underground cables or gas pipes may cause an explosion and / or fire. This may result in severe, potentially fatal injury.

- Before doing any trenching work, check the course of cables, gas pipes and water pipes.
- Observe the statutory minimum distance from cables, gas pipes and water pipes. Never look into the end of an inadvertently severed fibre-optics cable, as that may severely injure the eyes.

Contact the local authorities and / or supply enterprises (electricity, gas, water, sewage, telecommunications etc.) to obtain information on underground supply lines.

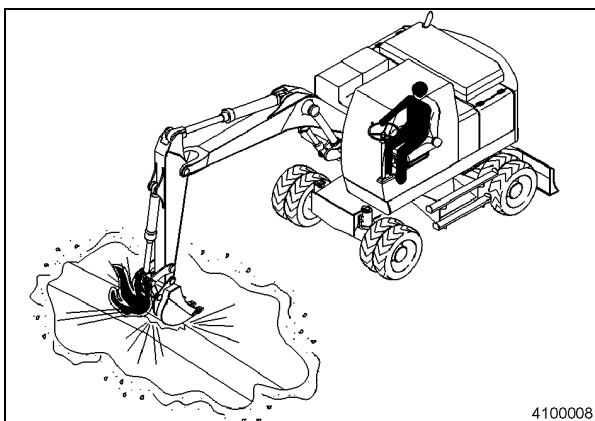

4100008

Fig. 8

Distance from overhead power lines



Severe, potentially fatal injury may result from the machine or the front equipment not being kept well clear of overhead power lines.

- If work is being done close to an overhead power line, no part of the machine or the load must come within a distance of 3 m plus twice the length of the overhead power line insulator from the power line.
- Check out and observe the relevant local regulations.
- Wet ground increases the range in which a person may get an electric shock.
- Keep all persons or colleagues clear of the location.

After contacting live wires

- Do not leave the machine.
- Drive the machine out of the hazard zone. Warn others against approaching and touching the machine.
- Have the live wire de-energized.

Do not leave the machine until the contacted / damaged line has been de-energized with absolute certainty.

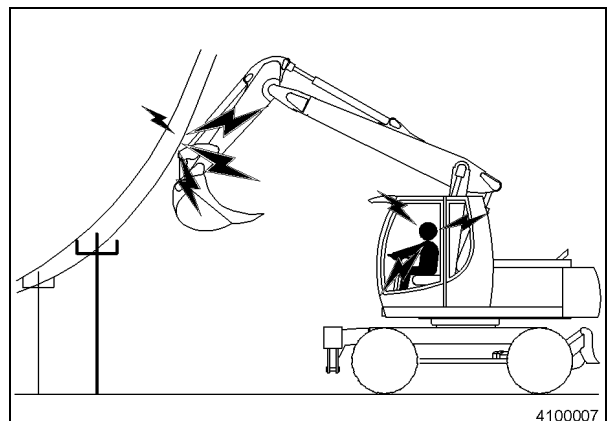

4100007

Fig. 9

Accident Prevention when reversing and slewing



Any person in the immediate vicinity of the machine may be hit or run over when the machine is being reversed or the superstructure is being slewed. This may result in severe, potentially fatal injury.

To prevent accidents during reversing and slewing:

- Enlist the assistance of a marshaller if your view is restricted.
- Always look in all directions **before** reversing or slewing. Make sure there is no one in the immediate vicinity.
- Keep the acoustic reversing alarm (if present) in a good operating state.
- Always be prepared for the possibility of persons entering the hazard zone. Use the horn or another signal to warn any persons in the immediate vicinity.
- Enlist a marshaller for reversing if your view is restricted. Always ensure that the marshaller is within sight.
- The machine must not be moved until agreement has been reached with the marshaller on correct interpretation of the signals.
- Familiarize yourself with the meaning of all markings, signs and designations used in the operation and come to an agreement on them with the marshaller.



- Keep windows, mirrors and headlamps clean and in good order.
- Dust, heavy rain, fog, etc. may reduce visibility. If this is the case, reduce your speed and switch on appropriate lighting.

Read the Owner's Manual carefully.

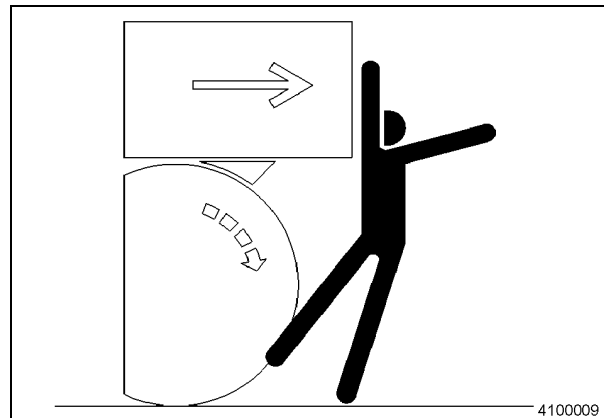

Fig. 10

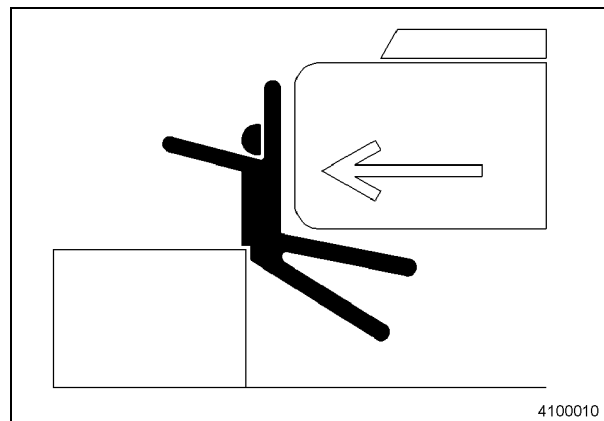

Fig. 11

Rules for driving on the road



The machine must not be driven on the public highway unless the conditions of the "General Operating Permit" are observed or, in the event of deviations from the "General Operating Permit", a vehicle-specific operating permit has been granted. These permits must be present in the cab during such travel.

- Always have a warning triangle, warning lamp and first-aid kit on board.
- Bring the working equipment into a position in which the maximum machine dimensions are not exceeded.
- Switch the bucket/grab switchover valve to "Grab" position. The bucket cylinder is then hydraulically blocked.
- Mount clearance lamp on stick and connect to a socket.
- Raise levelling blade completely and attach a reflector.
- Raise claws (option) completely and block mechanically.
- Switch off floodlamps.
- Lock superstructure.

Recovering and towing the machine



Tow the machine with a tow-rod or towing rope only.

The tow-rod or rope must be free from damage. They must be dimensioned in such a way that the calculated breaking load is equal to three times the tractive power of the towing machine.

The towing vehicle must have adequate tractive power.

Drive slowly, carefully and smoothly.

All persons must keep clear of the tow-rod or rope.



- Tow only if the brakes and the steering of the machine are functioning properly and if the machine cannot be otherwise transported.
- Tow defective machines only as far as necessary to recover the machine from hazardous areas.
- After the recovery, the machine must be secured against inadvertent movements and unauthorized starting.
- Have the machine repaired before transporting it over greater distances, or load it onto a transport vehicle.
- The machine is not suitable for towing trailers or other vehicles over longer distances; this would result in damage to axles and gearboxes. The tow coupling is designed solely for towing or recovering vehicles from hazardous areas or for lashing purposes on transport vehicles.



Suggest:

If the above button click is invalid.

Please download this document

first, and then click the above link

to download the complete manual.

Thank you so much for reading

Travelling uphill and downhill



Before starting up the machine, read through the Owner's Manual carefully.

- Before driving the machine, put it into neutral position (see Owner's Manual).
- Never drive down slopes with a gradient of more than 30°. Take an alternative route with lower gradients.
- Keep the bucket 20 - 30 cm above the ground on the uphill side while travelling uphill or downhill.
- If the machine starts to slip or to lose its stability, lower the bucket immediately.
- Driving across slopes may cause the machine to slip or overturn.
- Steering manoeuvres on slopes may cause the machine to overturn.
- Never coast downhill. This may result in a loss of control over the vehicle and in severe damage to property as well as fatal injury.
- Always change to first gear before the downhill / uphill slope. This increases the brake action of the travel motor, preventing inadmissibly high travel speeds.
- When working on a slope, the fuel tank must be topped up as soon as the fuel indicator lights up.

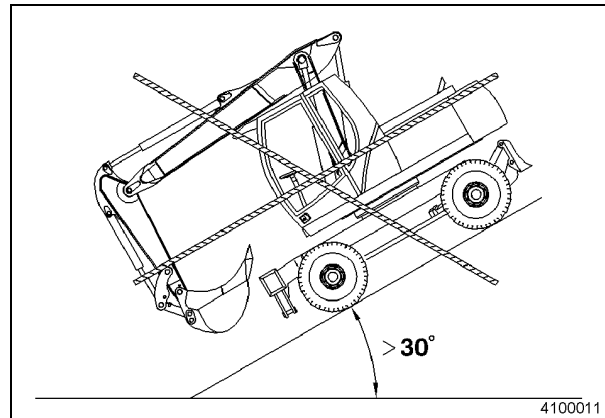

Fig. 12

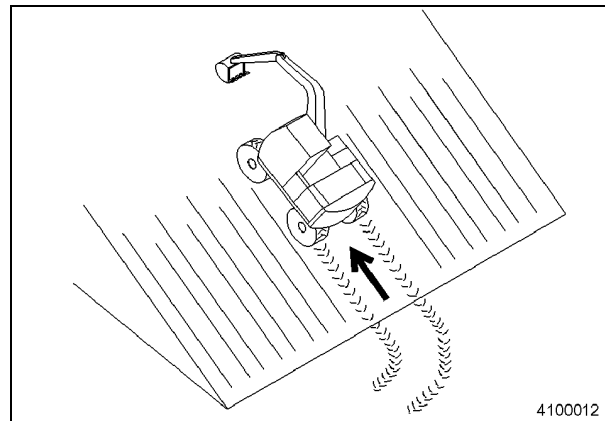

Fig. 13

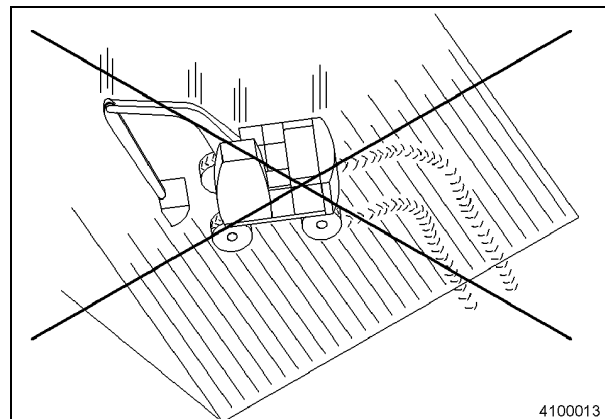

Fig. 14

<https://www.ebooklibonline.com>

Hello dear friend!

Thank you very much for reading.

Enter the link into your browser.

The full manual is available for immediate download.

<https://www.ebooklibonline.com>