



REPAIR MANUAL



LS180.B
LS185.B
LS190.B
LT185.B
LT190.B

Contents

INTRODUCTION	
DISTRIBUTION SYSTEMS	A
POWER PRODUCTION	B
POWER TRAIN	C
TRAVELLING	D
BODY AND STRUCTURE	E
WORKING ARM	H
TOOLS AND COUPLERS	J



INTRODUCTION

<https://www.ebooklibonline.com>

Hello dear friend!

Thank you very much for reading.

Enter the link into your browser.

The full manual is available for immediate download.

<https://www.ebooklibonline.com>

Contents

INTRODUCTION

Basic instructions (- A.90.A.05)	3
LS185.B, LS190.B, LT185.B, LT190.B, LS180.B	
Torque (- A.90.A.10)	7
LS185.B, LS190.B, LT185.B, LT190.B, LS180.B	
Conversion factors (- A.92.A.21)	11
LS185.B, LS190.B, LT185.B, LT190.B, LS180.B	

Basic instructions (- A.90.A.05)

LS185.B, LS190.B, LT185.B, LT190.B, LS180.B

Technical Information

This manual has been produced by a new technical information system. This new system is designed to deliver technical information electronically through CDROM and in paper manuals. A coding system called ICE has been developed to link the technical information to other Product Support functions e.g. Warranty.

Technical information is written to support the maintenance and service of the functions or systems on a customer's machine. When a customer has a concern on his machine it is usually because a function or system on his machine is not working at all, is not working efficiently, or is not responding correctly to his commands. When you refer to the technical information in this manual to resolve that customer's concern, you will find all the information classified using the new ICE coding, according to the functions or systems on that machine. Once you have located the technical information for that function or system then you will find all the mechanical, electrical or hydraulic devices, components, assemblies and sub-assemblies for that function or system. You will also find all the types of information that have been written for that function or system, the technical data (specifications), the functional data (how it works), the diagnostic data (fault codes and troubleshooting) and the service data (remove, install adjust, etc.).

By integrating this new ICE coding into technical information, you will be able to search and retrieve just the right piece of technical information you need to resolve that customer's concern on his machine. This is made possible by attaching 3 categories to each piece of technical information during the authoring process.

The first category is the Location, the second category is the Information Type and the third category is the Product:

- **LOCATION** - is the component or function on the machine, that the piece of technical information is going to describe e.g. Fuel tank.
- **INFORMATION TYPE** - is the piece of technical information that has been written for a particular component or function on the machine e.g. Capacity would be a type of Technical Data that would describe the amount of fuel held by the Fuel tank.
- **PRODUCT** - is the model that the piece of technical information is written for.

Every piece of technical information will have those 3 categories attached to it. You will be able to use any combination of those categories to find the right piece of technical information you need to resolve that customer's concern on his machine.

That information could be:

- the description of how to remove the cylinder head
- a table of specifications for a hydraulic pump
- a fault code
- a troubleshooting table
- a special tool

How to Use this Manual

This manual is divided into Sections. Each Section is then divided into Chapters. Contents pages are included at the beginning of the manual, then inside every Section and inside every Chapter. An alphabetical Index is included at the end of a Chapter. Page number references are included for every piece of technical information listed in the Chapter Contents or Chapter Index.

Each Chapter is divided into four Information types:

- **(D) Technical Data** (specifications) for all the mechanical, electrical or hydraulic devices, components and assemblies.
- **(C) Functional Data** (how it works) for all the mechanical, electrical or hydraulic devices, components and assemblies.
- **(G) Diagnostic Data** (fault codes, electrical and hydraulic troubleshooting) for all the mechanical, electrical or hydraulic devices, components and assemblies.

INTRODUCTION

- **(F)** Service data (remove disassembly, assemble, install) for all the mechanical, electrical or hydraulic devices, components and assemblies.

Sections

Sections are grouped according to the main functions or a systems on the machine. Each Section is identified by a letter A, B, C etc. The amount of Sections included in the manual will depend on the type and function of the machine that the manual is written for. Each Section has a Contents page listed in alphabetic/numeric order. This table illustrates which Sections could be included in a manual for a particular product.

PRODUCT	SECTION									
	A - Distribution Systems									
	B - Power Production									
	C - Power Train									
	D - Travelling									
	E - Body and Structure									
	F - Frame Positioning									
	G - Tool Positioning									
	H - Working Arm									
	J - Tools and Couplers									
K - Crop Processing										
L - Field Processing										
Tractors	X	X	X	X	X	X	X	X	X	
Vehicles with working arms: backhoes, excavators, skid steers,	X	X	X	X	X	X	X	X	X	
Combines, forage harvesters, balers,	X	X	X	X	X	X	X	X	X	X
Seeding, planting, floating, spraying equipment,	X	X	X	X	X	X		X		X
Mounted equipment and tools,					X	X	X		X	

Chapters

Each Chapter is identified by a letter and number combination e.g. Engine B.10.A The first letter is identical to the Section letter i.e. Chapter B.10 is inside Section B, Power Production.

CONTENTS

The Chapter Contents lists all the **(D)** technical data (specifications), **(C)** functional data (how it works), **(F)** service data (remove, install adjust, etc..) and **(G)** diagnostic data (fault codes and troubleshooting) that have been written in that Chapter for that function or system on the machine.

Contents

POWER PRODUCTION ENGINE _ 10.A

TECHNICAL DATA

ENGINE - General specification (B.10.A - D.40.A.10) 3

FUNCTIONAL DATA

ENGINE - Dynamic description (B.10.A - C.30.A.10) 4

SERVICE

ENGINE - Remove (B.10.A - F.10.A.10) 5

DIAGNOSTIC

ENGINE - Troubleshooting (B.10.A - G.40.A.10) 6

INDEX

The Chapter Index lists in alphabetical order all the types of information (called Information Units) that have been written in that Chapter for that function or system on the machine.

Index

POWER PRODUCTION - B ENGINE		
ENGINE - Dynamic description (B.10.A - C.30.A.10)		4
ENGINE - General specification (B.10.A - D.40.A.10)		3
ENGINE - Remove (B.10.A - F.10.A.10)		5
ENGINE - Troubleshooting (B.10.A - G.40.A.10)		6

Information Units and Information Search

Each chapter is composed of information units. Each information unit has the ICE code shown in parentheses which indicates the function and the type of information written in that information unit. Each information unit has a page reference within that Chapter. The information units provide a quick and easy way to find just the right piece of technical information you are looking for.

example information unit	Stack valve - Sectional View (A.10.A.18 - C.10.A.30)				
Information Unit ICE code	A	10.A	18	C	10.A.30
ICE code classification	Distribution systems	Primary hydraulic power	Stack valve	Functional data	Sectional view

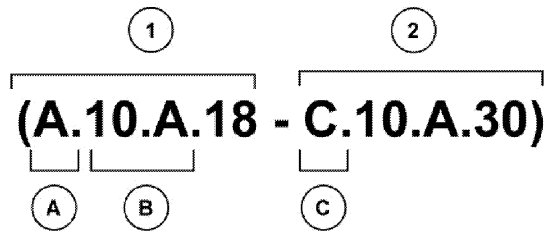

CRIL03J033E01 1

Navigate to the correct information unit you are searching for by identifying the function and information type from the ICE code.

- **(1)** Function and **(2)** Information type.
- **(A)** corresponds to the sections of the repair manual.
(B) corresponds to the chapters of the repair manual.
(C) corresponds to the type of information listed in the chapter contents, **(D)** Technical data, **(E)** Functional Data, **(G)** Diagnostic or **(F)** Service.
(A) and **(B)** are also shown in the page numbering on the page footer.
 THE REST OF THE CODING IS NOT LISTED IN ALPHA-NUMERIC ORDER IN THIS MANUAL.
- You will find a table of contents at the beginning and end of each section and chapter.
 You will find an alphabetical index at the end of each chapter.
- By referring to **(A)**, **(B)** and **(C)** of the coding, you can follow the contents or index (page numbers) and quickly find the information you are looking for.



REPAIR MANUAL

DISTRIBUTION SYSTEMS



LS180.B
LS185.B
LS190.B
LT185.B
LT190.B

Contents

DISTRIBUTION SYSTEMS - A

PRIMARY HYDRAULIC POWER SYSTEM LS180.B, LS185.B, LS190.B, LT185.B, LT190.B	A.10.A
SECONDARY HYDRAULIC POWER SYSTEM LS180.B, LS185.B, LS190.B, LT185.B, LT190.B	A.12.A
HIGH-FLOW HYDRAULIC POWER SYSTEM LS180.B, LS185.B, LS190.B, LT185.B, LT190.B	A.16.A
ELECTRICAL POWER SYSTEM LS180.B, LS185.B, LS190.B, LT185.B, LT190.B	A.30.A
LIGHTING SYSTEM LS180.B, LS185.B, LS190.B, LT185.B, LT190.B	A.40.A

Hydraulic pump - Disassemble (A.10.A.20 - F.10.A.25)

LS185.B, LS190.B, LT185.B, LT190.B, LS180.B

1. Draw alignment marks on the housing with a white marker. These marks will be referenced during assembly.

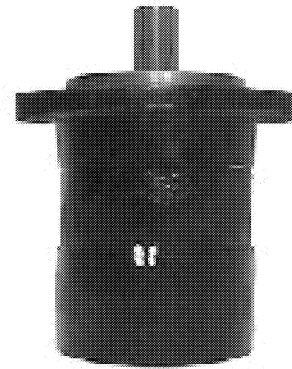

GD98J801 1

2. Loosen and remove the socket bolts and washers.



GD98J802 2

3. Remove the cover.



GD98J803 3

DISTRIBUTION SYSTEMS - PRIMARY HYDRAULIC POWER SYSTEM

4. Remove the gear plate.



GD98J804 4

5. Remove the dowel pins.

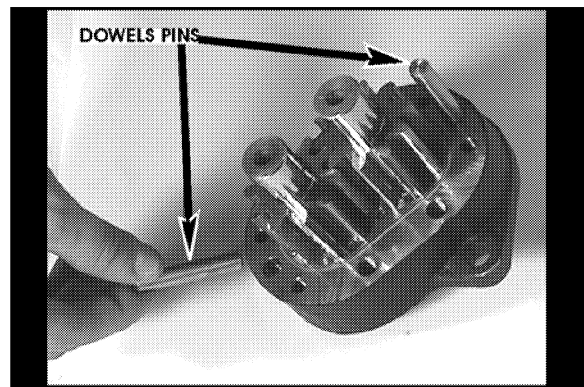

GD98J805_2 5

6. Rotate the gear teeth until one gear tooth is centered inside two gear teeth. Draw a mark with a white marker. This mark will be referenced during assembly.

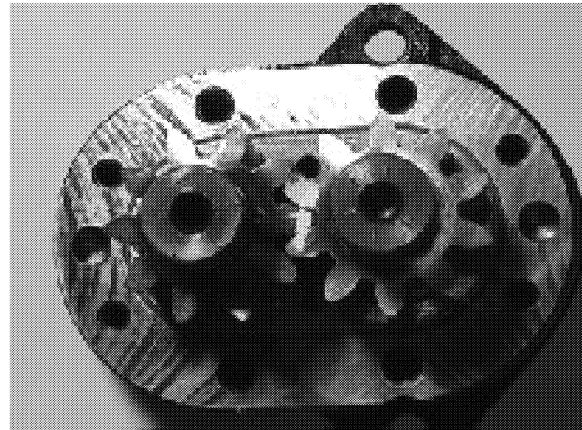

GD98J806 6

7. Remove the drive shaft.

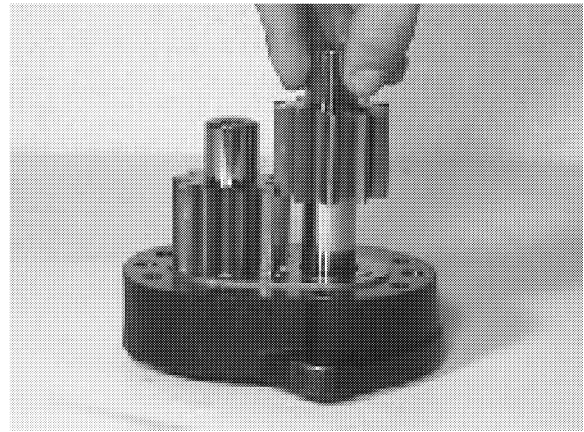

GD98J807 7

8. Remove the idler shaft.

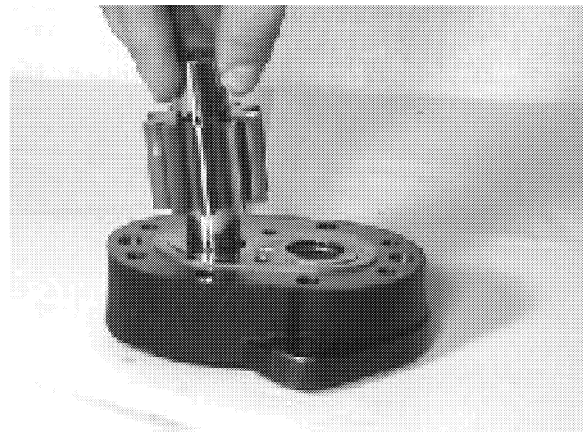

GD98J808 8

9. Remove the wear plate from the cover.

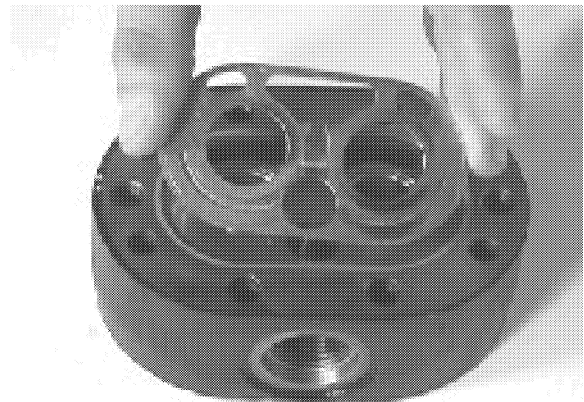

GD98J809 9

10. Remove the wear plate from the body.

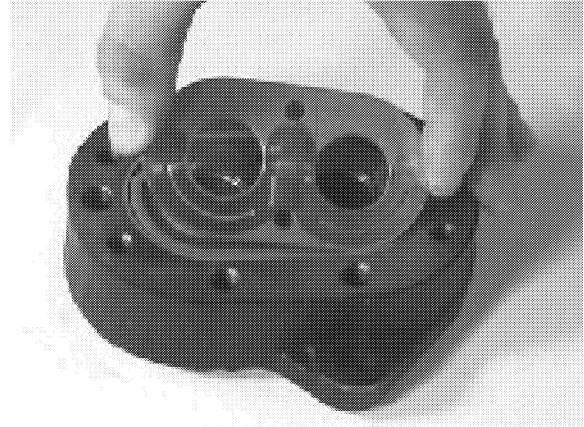

GD98J810 10

11. Remove and discard the seal ring from the cover.

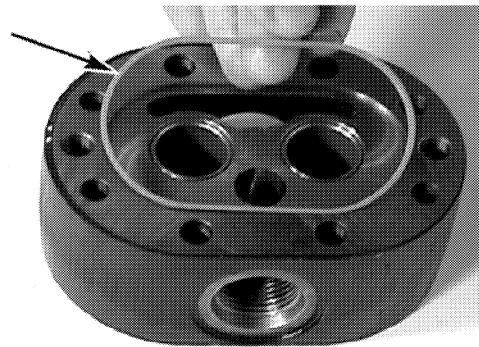

GD98J811_2 11

12. Remove and discard the seal ring from the body.

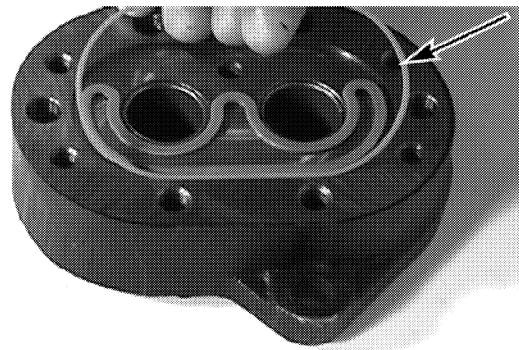

GD98J812_2 12

13. Remove and discard the top seal from the body.

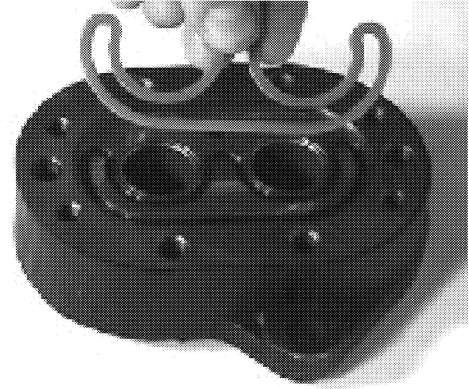

GD98J813 13

14. Remove and discard the bottom seal from the body.

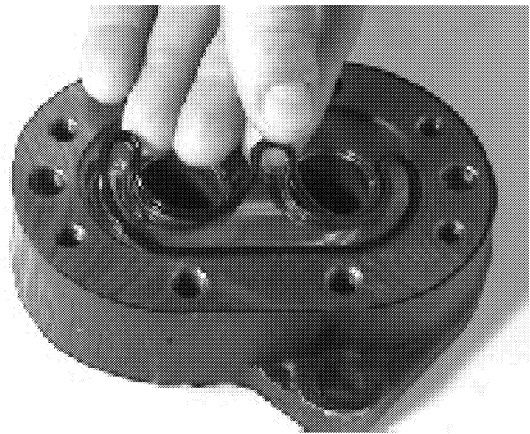

GD98J814 14

Hydraulic pump - Visual inspection (A.10.A.20 - F.40.A.10)

LS185.B, LS190.B, LT185.B, LT190.B, LS180.B

1. Inspect the brass surfaces of the wear plates for wear. Replace as required.

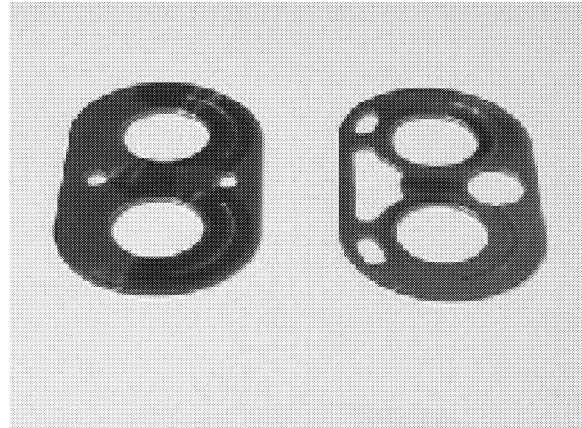

GD98J815 1

2. Inspect the drive and idler shafts for wear or damage. Replace as required.

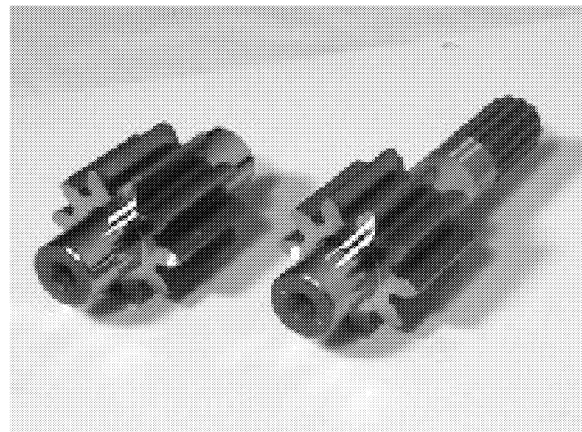

GD98J816 2

3. Inspect the bearing sleeves of the drive and idler shafts in the body and cover for wear or damage. Replace as required.

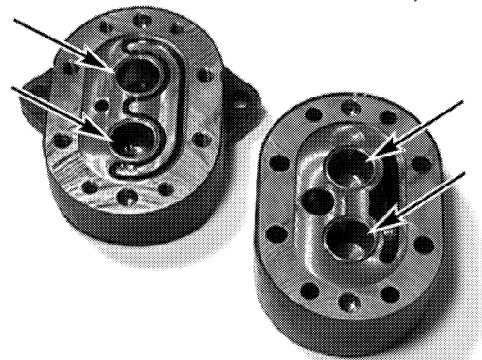

GD98J817_2 3

4. Inspect the body and cover surfaces for wear or damage. Replace as required.

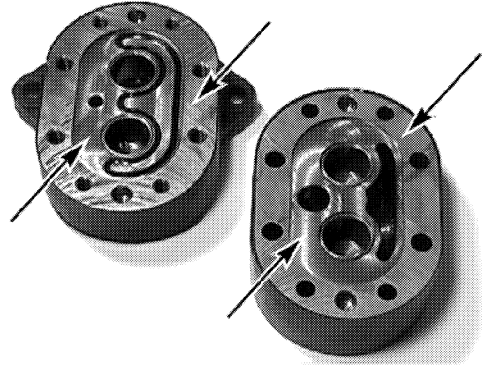

GD98J818_2 4



Suggest:

If the above button click is invalid.

Please download this document

first, and then click the above link

to download the complete manual.

Thank you so much for reading

Hydraulic pump - Assemble (A.10.A.20 - F.10.A.20)

LS185.B, LS190.B, LT185.B, LT190.B, LS180.B

1. Lubricate the bottom seal with clean hydraulic oil and insert the bottom seal into the groove of the body.

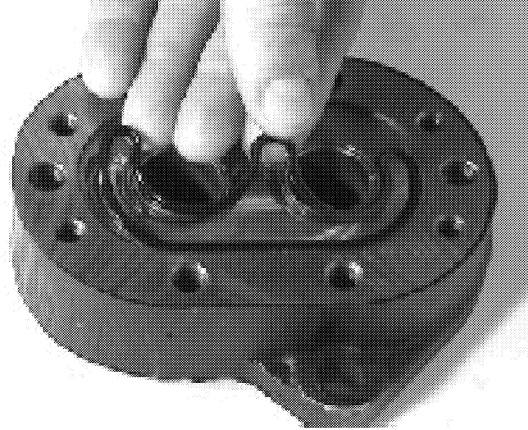

GD98J814 1

2. Lubricate the top seal with clean hydraulic oil and insert the top seal into the groove of the body.

NOTE: The top seal will be placed on top of the bottom seal.

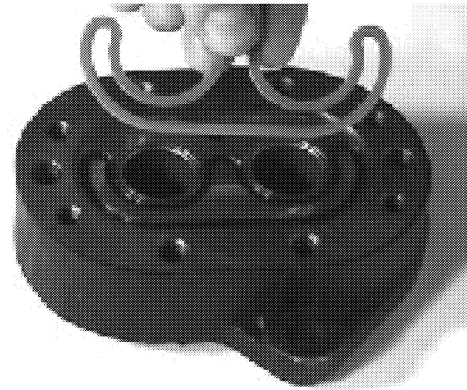

GD98J813 2

3. Lubricate the new seal ring with clean hydraulic oil and insert the new seal ring into the groove of the body.

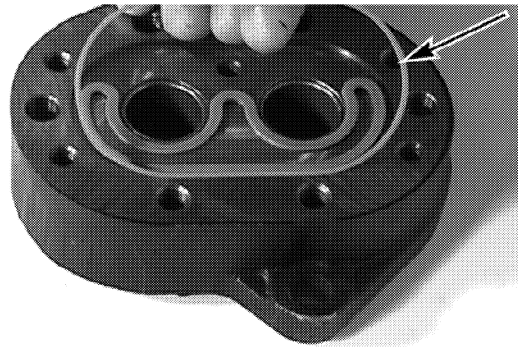

GD98J812_2 3

<https://www.ebooklibonline.com>

Hello dear friend!

Thank you very much for reading.

Enter the link into your browser.

The full manual is available for immediate download.

<https://www.ebooklibonline.com>