

FORD

455 TRACTOR-LOADER- BACKHOE

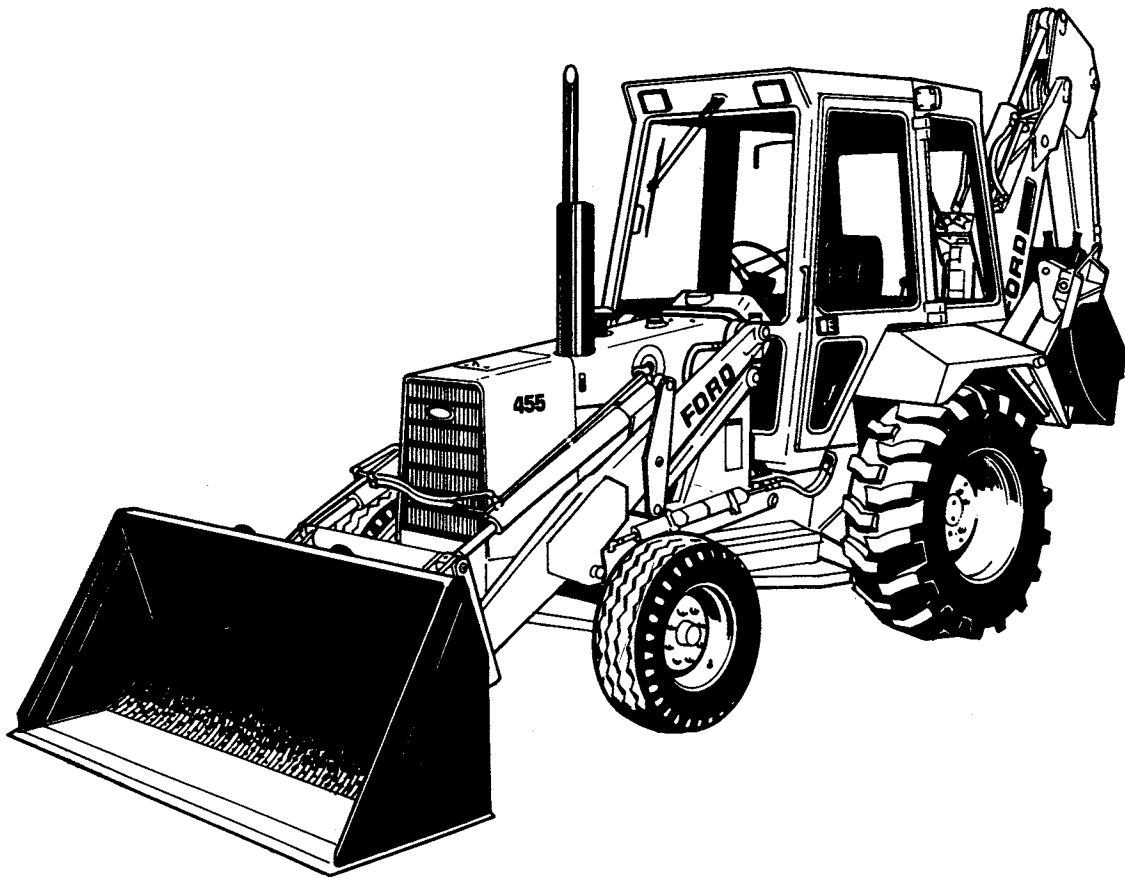

REPAIR MANUAL

Ford New Holland, Inc
New Holland, PA 17557

40045510
Reprinted

FOREWORD

This manual provides information for the proper servicing and overhaul of the Ford Model 455 Tractor-Loader-Backhoe and is an essential publication for all service personnel carrying out repairs and maintenance procedures.

The Manual is divided into twelve PARTS, each sub-divided into Chapters. Each Chapter contains information on general operating principles, detailed inspection and overhaul and, where applicable, trouble shooting, special tools and specifications.

The material contained in this Manual was correct at the time of printing, but Ford New Holland, Inc. policy is one of continuous improvement and the right to change prices, specifications, equipment or design at anytime without notice is reserved. All data in this Manual is subject to production variations, so overall dimensions and weights should be considered as approximate only and the illustrations do not necessarily depict the unit to standard build specification.

FORD NEW HOLLAND, INC.



SAFETY PRECAUTIONS



Practically all service work involves the need to drive the tractor. The Operator's Manual, supplied with each tractor, contains detailed safety precautions relating to driving, operating and servicing that tractor. These precautions are as applicable to the service technician as they are to the operator, and should be read, understood and practiced by all personnel.

Prior to undertaking any maintenance, repair, overhaul, dismantling or re-assembly operations, whether within a workshop facility or out "in the field," consideration should be given to factors that may have an effect upon safety, not only upon the mechanic carrying out the work, but also upon bystanders.

PERSONAL CONSIDERATIONS

- The wrong clothes or carelessness in dress can cause accidents. Check to see that you are suitably clothed.
Some jobs require special protective equipment.
- **Skin Protection**
Used engine oil may cause skin cancer. Follow work practices that minimize the amount of skin exposed and the length of time used oil remains on the skin.
- **Eye Protection**
The smallest eye injury may cause loss of vision. Injury can be avoided by wearing eye protection when engaged in chiselling, grinding, discing, welding, painting, etc.
- **Breathing Protection**
Fumes, dust and paint spray are unpleasant and harmful. These can be avoided by wearing respiratory protection.
- **Hearing Protection**
Loud noise may damage your hearing and the greater the exposure the worse the damage. If you feel the noise is excessive, wear ear protection.
- **Hand Protection**
It is advisable to use a protective cream before work to prevent irritation and skin contamination. After work clean your hands with soap and water. Solvents such as white spirit, paraffin, etc., may harm the skin.
- **Foot Protection**
Substantial or protective footwear with reinforced toe-caps will protect your feet from falling objects. Additionally, oil-resistant soles will help to avoid slipping.
- **Special Clothing**
For certain work it may be necessary to wear flame or acid-resistant clothing.
- Avoid injury through incorrect handling of components. Make sure you are capable of lifting the object. If in doubt get help.

EQUIPMENT CONSIDERATIONS

- **Machine Guards**
Before using any machine, be sure the machine guards are in position and serviceable. These guards not only prevent body and clothing from coming in contact with the moving parts of the machine, but also ward off objects that might fly off the machine and cause injury.
- **Lifting Appliances**
Always ensure that lifting equipment, such as chains, slings, lifting brackets, hooks and eyes are thoroughly checked before use. If in doubt, select stronger equipment than is necessary.

Never stand under a suspended load or a raised implement.

<https://www.ebooklibonline.com>

Hello dear friend!

Thank you very much for reading.

Enter the link into your browser.

The full manual is available for immediate download.

<https://www.ebooklibonline.com>

- **Compressed Air**

The pressure from a compressed air line is often as high as 100 psi (6.9 bar) 7 (kgf/cm²). It is perfectly safe if used correctly. Any misuse may cause injury.

Never use compressed air to blow dust, filing, dirt, etc., away from your work area unless the correct type of nozzle is fitted.

Compressed air is not a cleaning agent, it will only move dust, etc., from one place to another. Look around before using an air hose as bystanders may get grit into their eyes, ears or skin.

- **Hand Tools**

Many cuts, abrasions and injuries are caused by defective tools. Never use the wrong tool for the job, as this generally leads either to some injury, or to a poor job.

Never use

- A hammer with a loose head or split handle.
- Spanners or wrenches with splayed or worn jaws.
- Spanners or files as hammers; or drills, clevis pins or bolts as punches.

For removing or replacing hardened pins use a copper or brass drift rather than a hammer.

For dismantling, overhaul and assembly of major and sub components, always use the Special Service Tools recommended. They will reduce effort, labor and repair cost.

Always keep tools clean and in good working order.

- **Electricity**

Electricity has become so familiar in day to day usage, that it's potentially dangerous properties are often overlooked. Misuse of electrical equipment can endanger life.

Before using any electrical equipment — particularly portable appliances — make a visual check to make sure that the cable is not worn or frayed and that the plugs, sockets, etc., are intact. Make sure you know where the nearest isolating switch for your equipment is located.

GENERAL CONSIDERATIONS

- **Solvents**

Use only cleaning fluids and solvents that are known to be safe. Certain types of fluids can cause damage to components such as seals, etc., and can cause skin irritation. Use only solvents that are suitable for the cleaning of components and parts, and that do not affect the personal safety of the user.

- **Housekeeping**

Many injuries result from tripping or slipping over, or on, objects or material left lying around by a careless worker. Prevent these accidents from occurring. If you notice a hazard, don't ignore it — remove it.

A clean, hazard-free place of work improves the surroundings and daily environment for everybody.

- **Fire**

Fire has no respect for persons or property. The destruction that a fire can cause is not always fully realized. Everyone must be constantly on guard.

- Extinguish matches/cigars/cigarettes, etc., before throwing them away.
- Work cleanly, disposing of waste material into proper containers.
- Locate the fire extinguishers and find out how to operate them.
- Do not panic — warn those near and raise the alarm.
- Do not allow or use an open flame near the tractor fuel tank, battery or component parts.

- **First Aid**
In the type of work that mechanics are engaged in, dirt, grease, fine dusts, etc., all settle upon the skin and clothing. If a cut, abrasion or burn is disregarded it may be found that a septic condition has formed within a short time. What appears at first to be trivial could become painful and injurious. It only takes a few minutes to have a fresh cut dressed, but it will take longer if you neglect it. Make sure you know where the First Aid box is located.
- **Cleanliness**
Cleanliness of the tractor hydraulic system is essential for optimum performance. When carrying out service and repairs plug all hose ends and component connections to prevent dirt entry.

Clean the exterior of all components before carrying out any form of repair. Dirt and abrasive dust can reduce the efficiency and working life of a component and lead to costly replacement. Use of a high pressure washer or steam cleaner is recommended.

OPERATIONAL CONSIDERATIONS

- Stop the engine, if at all possible, before performing any service.
- Place a warning sign on tractors which, due to service or overhaul, would be dangerous to start. Disconnect the battery leads if leaving such a unit unattended.
- Do not attempt to start the engine while standing beside the tractor or attempt to by-pass the neutral start switch.
- Avoid prolonged running of the engine in a closed building or in an area with inadequate ventilation as exhaust fumes are highly toxic.
- Always turn the radiator cap to the first stop to allow pressure in the system to dissipate when the coolant is hot.
- Never work beneath a tractor which is on soft ground. Always take the unit to an area which has a hard working surface — concrete for preference.
- If it is found necessary to raise the tractor for ease of servicing or repair, make sure that safe and stable supports are installed beneath axle housings, casings, etc., before commencing work.
- Certain repair or overhaul procedures may necessitate "separating the tractor," either at the engine/front transmission or front transmission/rear transmission locations. These operations are simplified by the use of the Tractor Splitting Kit/Stands. Should this equipment not be available, then every consideration must be given to stability, balance and weight of the components, especially if a cab is installed on the tractor.
- Use footsteps or working platforms when servicing those areas of a tractor that are not within easy reach.
- Before loosening any hoses or tubes connecting implements to remote control valves, etc., switch off the engine, remove all pressure in the lines by operating levers several times. This will remove the danger of personal injury by oil pressure.
- Prior to pressure testing, make sure all hoses and connectors not only of the tractor, but also those of the test equipment, are in good condition and tightly sealed. Pressure readings must be taken with the gauges specified. The correct procedure should be rigidly observed to prevent damage to the system or the equipment, and to eliminate the possibility of personal injury.
- When equipment or implements are required to be attached to the hydraulic linkage, either for testing purposes or for transportation, then "position control" should be used.
- Always lower equipment to the ground when leaving the tractor.
- If high lift attachments are installed on a tractor beware of overhead power, electric or telephone cables when traveling. Drop attachment near to ground level to increase stability and minimize risks.

- Do not park or attempt to service a tractor on an incline. If unavoidable, take extra care and block all wheels.
- Escaping hydraulic/diesel fluid under pressure can penetrate the skin causing serious injury. Do not use your hand to check for leaks. Use a piece of cardboard or paper to search for leaks. Stop the engine and relieve the pressure before connecting or disconnecting oil lines. Tighten all connections before starting the engine or pressurizing the lines. If fluid is injected into the skin, obtain medical attention immediately or gangrene may result
- Observe recommended precautions as indicated in this Repair Manual when dismantling the air conditioning system as escaping refrigerant can cause frostbite.
- Prior to removing wheels and tires from a tractor, check to determine whether additional ballast (liquid or weights) has been added. Seek assistance and use suitable equipment to support the weight of the wheel assembly.
- When inflating tires beware of over inflation — constantly check the pressure. Overinflation can cause tires to burst and result in personal injury.
- Continuous long term contact with used engine oil may cause skin cancer. Avoid prolonged contact with used engine oil. Wash skin promptly with soap and water.
- Some components of your tractor, such as gaskets and friction surfaces (brake lining, clutch lining, etc.) may contain asbestos. Breathing asbestos dust is dangerous to your health. You are therefore advised to have any maintenance or repair operation on such components carried out by an authorized Ford New Holland Dealer. If, however, service operations are to be undertaken on parts that contain asbestos, the essential precautions listed below must be observed;
 - Work out of doors or in a well ventilated area.
 - Dust found on tractor or produced during work on the tractor should be dampened, placed in a sealed container and marked to ensure safe disposal.
 - If any cutting, drilling, etc., is attempted on materials containing asbestos, the items should be dampened and only hand tools or low speed power tools used.

Safety precautions are very seldom the figment of someone's imagination. They are the result of sad experience, where most likely someone has paid dearly through personal injury.

Heed these precautions and you will protect yourself accordingly. Disregard them and you may duplicate the sad experience of others.

PART 1 ENGINE SYSTEMS

Chapter 1 ENGINES

Section	Page
A. DIESEL ENGINE — DESCRIPTION AND OPERATION	1
B. DIESEL ENGINE — OVERHAUL.....	2

A. DIESEL ENGINE — DESCRIPTION AND OPERATION

This chapter describes the overhaul and repair of the Ford 455 direct injection diesel engine.

No of Cylinder	3
Bore	4.4 in. (111.8 mm)
Stroke	4.4 in. (111.8 mm)
Displacement	201 cu. in. (3294 cm ³)
Compression Ratio	16.3 to 1

The engine, Figure 1, features a cross flow cylinder head with the inlet and exhaust manifolds on opposite sides of the head.

The combustion chamber is formed in the crown of the piston which has two compression and one oil control ring all located above the piston pin.

The cylinder head assembly incorporates the valves, valve springs and spring retainers. Valve guides are an integral part of the cylinder head with replaceable valve seats pressed into the valve ports.

The crankshaft is supported in the cylinder block by four main bearings and the crankshaft end thrust bearing located on the second main bearing.

Front and rear crankshaft oil sealing is affected by one piece, single lip type seals.

The crankshaft rear main bearing carrier is sealed by an oil seal retainer, modified main bearing cap and a cork gasket which seals the face of the retainer to the block.

The piston connecting rods are "I" section and the fully floating piston pin is retained in the piston by two snap rings.

PRINTED IN U.S.A.

LUBRICATION SYSTEM

Lubrication of the engine is maintained by a rotor type oil pump mounted at the base of the engine block. The oil pump is driven from the camshaft and draws oil from the engine sump through a wire mesh screen.

A spring loaded relief valve in the pump body limits the pressure in the system by directing excess oil back to the intake side of the pump.

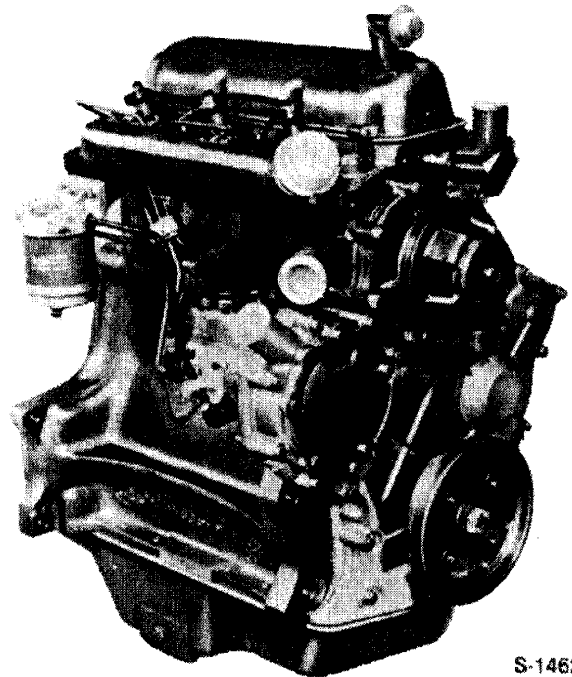

S-14621

Figure 1
3-Cylinder Diesel Engine with Rotary Type
Fuel Injection Pump

Oil passes from the pump to an external, throw-away, spin-on type filter incorporating a relief valve which permits oil to be bypassed if filter blockage occurs, and so assures engine lubrication at all times.

Oil flows from the filter to the main oil gallery which runs the length of the cylinder block and intersects the camshaft follower chambers.

The main gallery also supplies oil to the crankshaft main bearings and to the connecting rod journals via drillings in the crankshaft. Drilled passages from each main bearing direct oil to the camshaft bearings.

The camshaft drive gear bushing is pressure lubricated through a drilled passage from the front main bearing. The gear has small oil passages machined on both sides which allow the oil to escape.

The timing gears are lubricated by oil from the cam follower chamber and the pressure lubricated camshaft drive gear bushing.

Cylinder walls, pistons and piston pins are splash lubricated by the connecting rods and rotating crankshaft.

An intermittent flow of oil is directed to the valve rocker arm shaft assembly via a drilled passage in the cylinder block located vertically above the No. 1 camshaft bearing. This drilling aligns with a corresponding hole in the cylinder head. As the camshaft turns, holes in the camshaft and camshaft bearing align and a regulated stream of oil is directed to the cylinder head and on up the rocker arm shaft support bolt to the rocker shaft. The oil flows from the shaft through drilled holes in each rocker arm bushing to lubricate both ends of the arms. Excess oil flows down the push rods and assists in lubricating the cam followers before draining back into the sump through cored openings in the block.

B. DIESEL ENGINE — OVERHAUL

CYLINDER HEAD, VALVES AND RELATED PARTS

REMOVAL

Reference — Figure 2

NOTE: The cylinder head can be removed with the engine installed in the tractor.

1. Disconnect the battery.

2. Remove the vertical muffler.
3. Drain the radiator and cylinder block.
4. Shut off the heater hose taps then disconnect and plug the heater hose openings.
5. Remove the radiator top hose.
6. Shut off the main fuel tank tap.
7. Remove the hood panel assembly.
8. Disconnect the air inlet hose at the intake manifold.
9. Remove the vertical type exhaust pipe and bracket.
10. Bend the lock tabs back and remove the bolts, exhaust manifold and gasket.
11. Disconnect the cold start fuel lines at the fuel tank and thermostart unit. See Part 2, Chapter 1.
12. Remove the injection lines from the fuel injection pump and injectors. Cap the exposed openings in the pump, injectors and line ends.
13. Disconnect the fuel lines and remove the fuel filters from the inlet manifold.

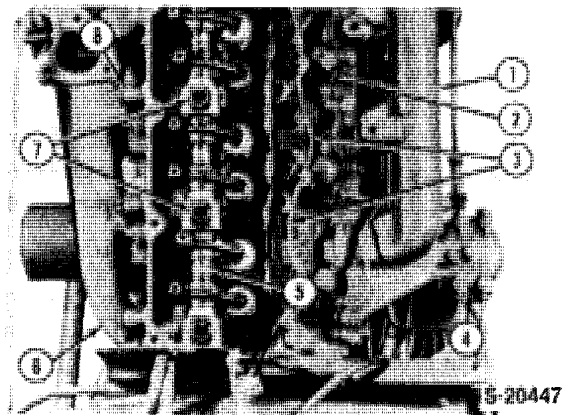

Figure 2
Engine with Rocker Arm Cover Removed

- | | |
|--------------------------|---------------------------------|
| 1. Intake Manifold | 6. Exhaust Manifold |
| 2. Injection Tubes | 7. Rocker Shaft Retaining Bolts |
| 3. Leak-Off Tubes | 8. Tab Washer |
| 4. Fuel Filter | |
| 5. Rocker Shaft Assembly | |

14. Remove the bolts and lock washers and remove the inlet manifold and gasket.
15. Remove the rocker cover bolts, rocker arm cover and gasket from the cylinder head.
16. Remove the fuel injector leak-off line. Clean the area surrounding the fuel injectors then remove the retaining nuts and carefully withdraw the fuel injectors and sealing washers from the head, Figure 3.
17. Check the push rods for straightness by rotating the rods with the valves closed and identify any bent rods.
18. Loosen the rocker shaft retaining bolts, which also serve as cylinder head bolts, evenly and alternately. Remove the rocker shaft assembly.

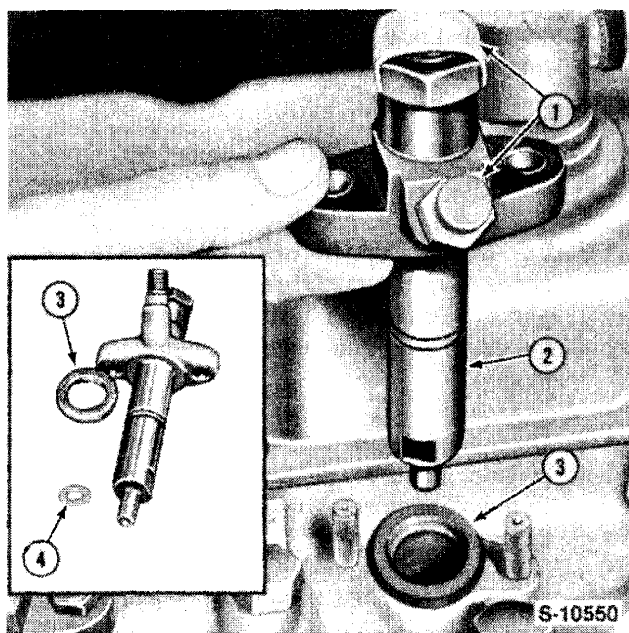

Figure 3
Fuel Injector Removed

- | | |
|--------------|-------------------------|
| 1. Dust Caps | 3. Dust Seal Washer |
| 2. Injector | 4. Injector Seal Washer |

NOTE: Leave the bolts in the rocker shaft support during removal as they retain the supports on the shaft.

19. Remove the push rods and place in a numbered rack for ease of assembly in their original position.

20. Remove the remaining cylinder bolts and washers working inward from the ends to the center of the head.
21. Lift the cylinder head from the block. If necessary, lever the head off the block at the pads provided, taking care not to damage the cylinder head or block surfaces, Figure 4.

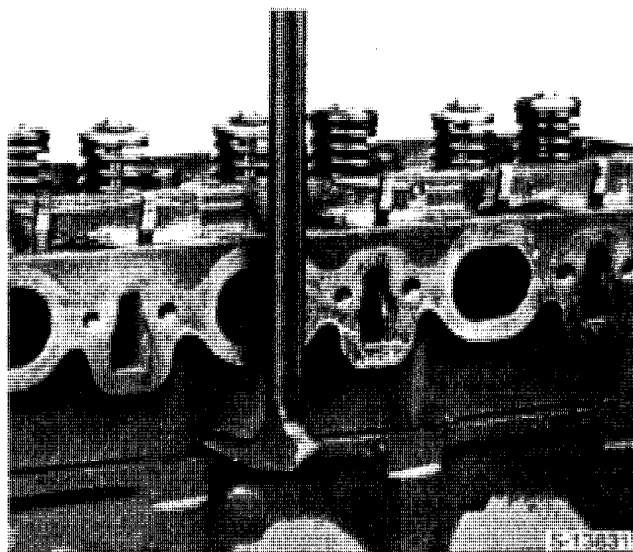

Figure 4
Cylinder Head Removal

DISASSEMBLY

THERMOSTAT:

1. Remove the coolant outlet connection and the thermostat and gasket, Figure 5.

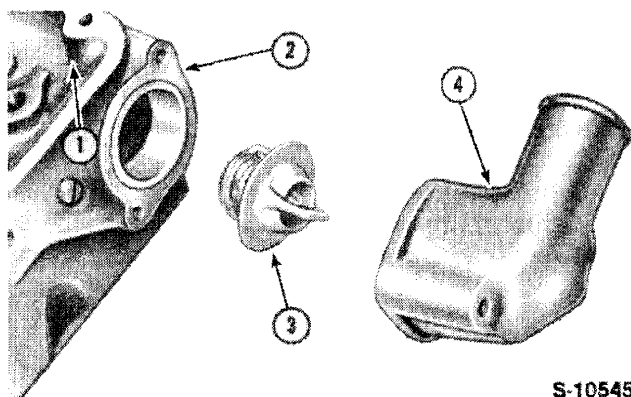

Figure 5
Coolant Outlet and Thermostat Removal

- | | |
|------------------|------------------------------|
| 1. Cylinder Head | 4. Coolant Outlet Connection |
| 2. Gasket | |
| 3. Thermostat | |

CYLINDER HEAD:

2. Clean the head and remove carbon deposits from around the valve heads.
3. Using a valve spring compressor, Figure 6, remove the retainer locks, spring retainers/rotators, springs and seals from each valve, Figures 7 and 8.
4. Remove the valves and place in a numbered rack together with the valve rotators (where fitted).

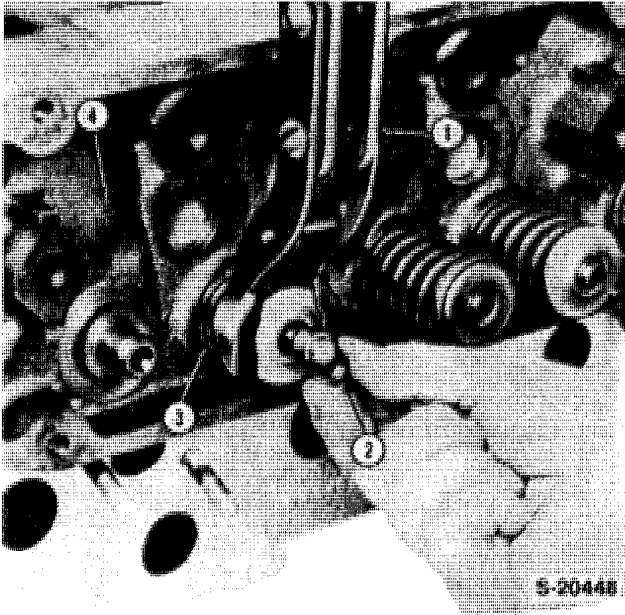
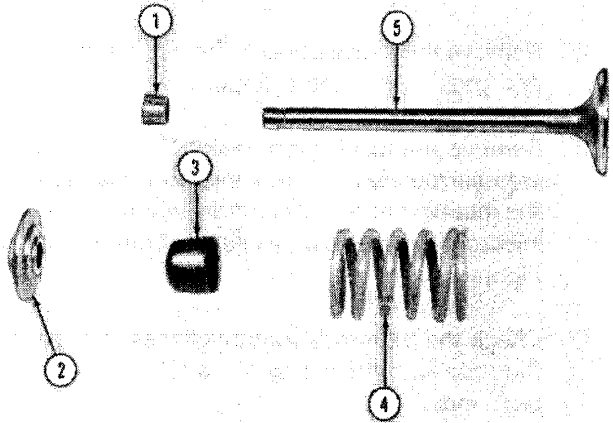

Figure 6
Valve Removal

- | | |
|----------------------------|------------------|
| 1. Valve Spring Compressor | 3. Valve Spring |
| 2. Retainer Locks | 4. Cylinder Head |



S-191

Figure 7

Intake Valve Assembly Components

- | | |
|--------------------------------------|-----------------------------|
| 1. Intake Valve Spring Retainer Lock | 3. Intake Valve Spring Seal |
| 2. Intake Valve Spring | 4. Intake Valve Spring |
| | 5. Intake Valve Retainer |

2. Inspect the cylinder head for damage and, if necessary, remove nicks and burrs from the gasket faces using a suitable abrasive. Be sure all traces of abrasive material are removed after repair.
3. Use a straight edge to check the flatness of the cylinder head in all directions, Figure 10. For flatness requirement see "Specifications," Chapter 3.

NOTE: *If the cylinder head exceeds the flatness specification it may be skimmed providing the depth from the lower face of the valve insert to the cylinder head face is not less than 0.117 in. (2.97 mm).*

4. After skimming the head, check whether any cylinder head bolts are bottoming by mounting the cylinder head on the block without a gasket and without any of the pistons at T.D.C. Install all the bolts finger tight and be sure the rocker shaft supports and flat washers are fitted with the long bolts. If a 0.010 in. (0.25 mm) feeler gauge can be inserted under the bolt head then the bolts are bottoming and the cylinder block thread must be increased in depth. Use a ½ in. x 13 UNC—2A thread tap.

ROCKER SHAFT ASSEMBLY:

5. Remove the cylinder head bolts which pass through the rocker shaft supports and slide the rocker shaft components from the shaft, Figure 9.

INSPECTION AND REPAIR

CYLINDER HEAD:

1. Scrape all gasket surfaces clean then wash the cylinder head in a suitable solvent and thoroughly dry with a lint free cloth or compressed air.

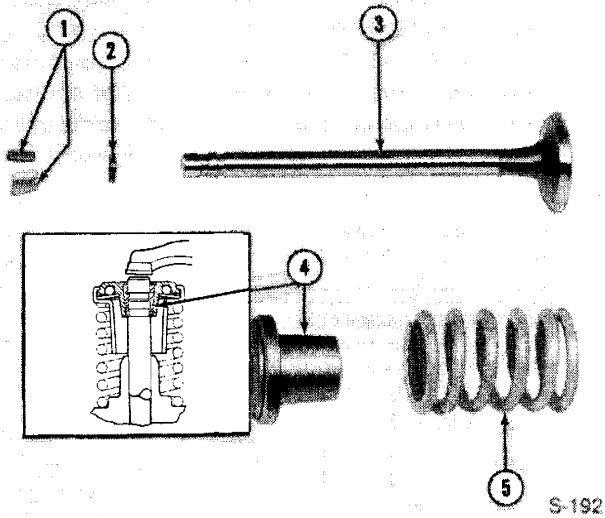

Figure 8
Exhaust Valve Assembly

- | | |
|--------------------------|--------------------|
| 1. Spring Retainer Locks | 3. Exhaust Valve |
| 2. Seal | 4. Spring Retainer |
| | 5. Spring |

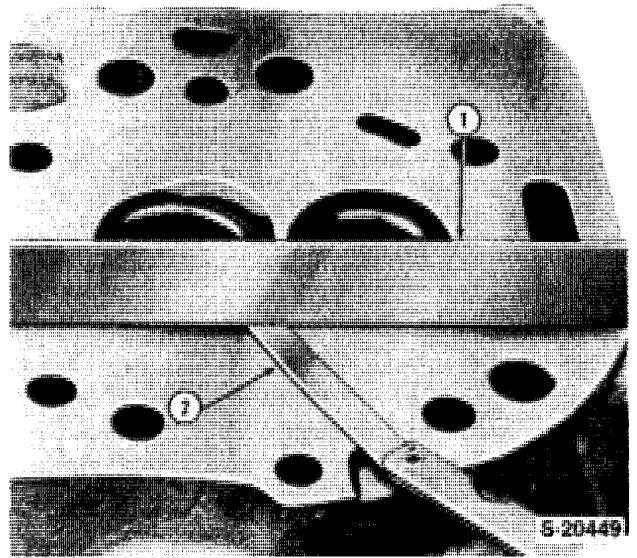

Figure 10
Measuring Cylinder Head Flatness

1. Straight Edge	2. Feeler Gauge
------------------	-----------------

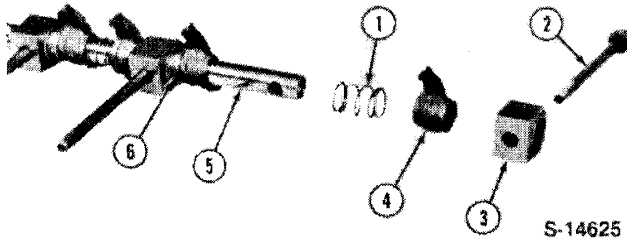

Figure 9
Rocker Shaft Disassembled

- | | |
|-------------------|---------------|
| 1. Spring | 4. Rocker Arm |
| 2. Retaining Bolt | 5. Shaft |
| 3. Shaft Support | 6. Spacer |

NOTE: Valve seat inserts of 0.010 in. (0.25 mm) and 0.020 in. (0.5 mm) oversize on diameter are sometimes installed in cylinder heads in production. Heads fitted with oversize inserts are stamped *S010* *S020* *OS* or *OS* on the exhaust manifold side in line with the valve seat concerned.

When replacing exhaust valve seat inserts be sure the replacement inserts are of the correct type as the size and material specification varies for different engine types.

- Check the width of the valve seat inserts and, if necessary, reface by grinding to the dimensions shown in Figure 11.

- Grind the seat to:

Intake	0.080"-0.102" (2.032-2.590 mm).
Exhaust	0.84"-0.106" (2.133-2.692 mm).

Lower or raise the seat by removing material from the seat using the following stones.

To lower the seat use a 30 degree stone. To raise the seat use a 60 degree stone.

NOTE: Refacing of the valve seat should always be coordinated with refacing of the valve to be sure of a compression tight fit.

VALVE SEATS:

- Examine the valve seat inserts and reface if pitted but replace if damaged. If necessary, install an oversize insert by machining the seat counterbore in the cylinder head, see "Specifications," Chapter 3. The insert must be chilled in dry-ice prior to installation.

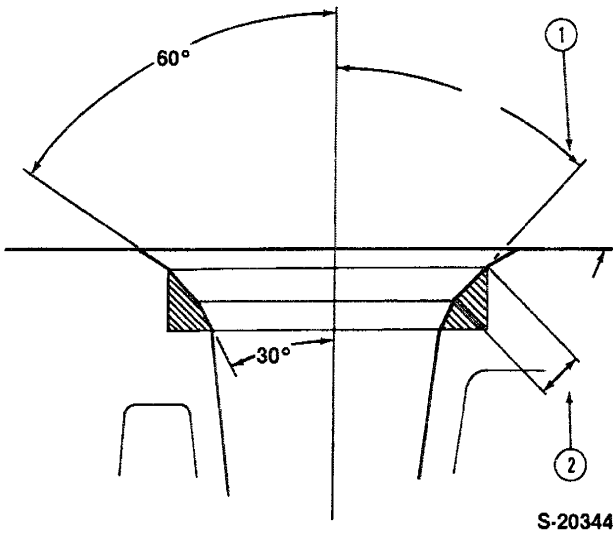

Figure 11

Valve Seat Dimensions

- | | |
|--|---|
| 1. Valve Seat Angle:
45° 00'—45° 30' for
all Valve Seats | 2. Valve Seat Width:
Intake 0.080—0.102
in. (2.032—2.590
mm)
Exhaust 0.084—
0.106 in. (2.133—
2.692 mm) |
|--|---|

IMPORTANT: The finished valve seat should contact the center of the valve face. Using the refaced or new valve, check the seat using Prussian Blue. Rotate the valve with a light pressure and if the blue is transferred to the middle of the valve face, the contact is correct, Figure 13.

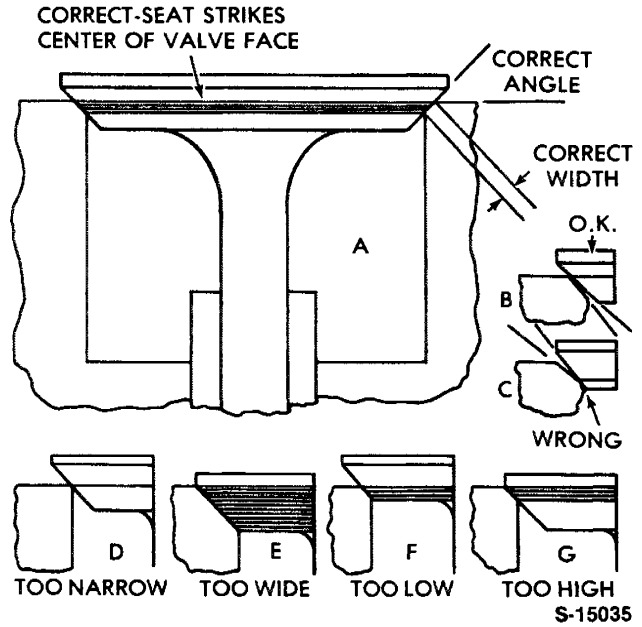

Figure 13
Valve Seating

VALVES:

- Examine the valve face and, if pitted, replace or reface by grinding to the dimension shown in Figure 12. Before refacing the valve, be sure the valve stem is not bent or worn and check the valve seat run-out, measured at right-angles to the seat, does not exceed a total of 0.0015 in. (0.038 mm). Measure the valve head margin to assure sufficient margin remaining after refacing.

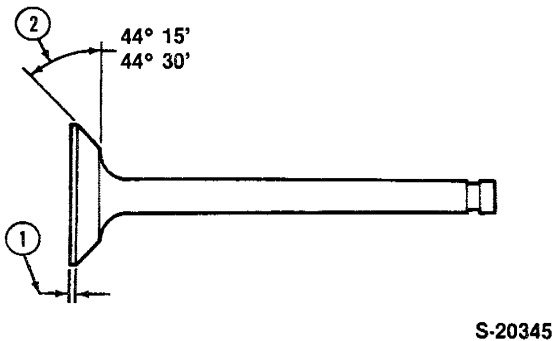

Figure 12

Intake and Exhaust Valves

- | | |
|---|---------------------|
| 1. Valve—Margin 0.031
in. (.787 mm)
minimum | 2. Valve—Face Angle |
|---|---------------------|

VALVE GUIDES:

- Using a telescopic gauge and micrometer, measure the valve to guide clearance, Figure 16. If the clearance exceeds the specified limits, see "Specifications," Chapter 3. Ream the valve guide to fit the next oversize valve.

NOTE: Production cylinder heads may have one or more 0.015 in. (0.38 mm) oversize valve guides and valves installed. Such cylinder heads have 15 or V015 or OS stamped on the exhaust manifold side of the head opposite the valve(s) concerned.

- Use Kit No. 2136 to ream out the valve guide to accept an oversize valve. The kit contains three reamer and pilot combinations as follows:

- 0.003 in. (0.076 mm) Oversize Reamer and Standard Diameter Pilot.

- 0.015 in. (0.38 mm) Oversize Reamer and 0.003 in. (0.076 mm) Oversize Pilot.
- 0.030 in. (0.76 mm) Oversize Reamer and 0.015 in. (0.38 mm) Oversize Pilot.

When going from a standard valve stem to an oversize always use the reamers in sequence. After reaming a valve guide, always check the valve seating and reface if necessary.

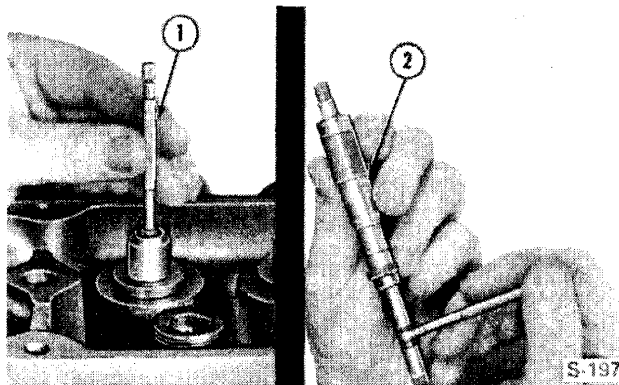

Figure 14
Measuring Valve Guide

1. Telescopic Gauge
2. Micrometer

VALVE SPRINGS:

11. Replace worn or damaged valve springs. Check for squareness and reject if out-of-squareness exceeds 0.06 in. (1.5 mm). Figure 15. Check the free length and loaded length of each valve spring, see "Specifications," Chapter 3. Be sure the valve spring retainer locks are in good condition and the exhaust valve rotators are not binding or worn.

ROCKER SHAFT ASSEMBLY:

12. Examine the rocker arm for wear or damage. Check the adjusting screw threads and replace if damaged. Inspect the rocker arm locating springs and spacers for damage. Check the rocker arm-to-shaft clearances and replace if beyond specified limits, see "Specifications," Chapter 3.
13. Clean the shaft in a suitable solvent and thoroughly dry with compressed air assuring the oil passages are free from obstruction.

THERMOSTAT:

14. For inspection and repair of the coolant outlet or thermostat, see "Cooling System," Chapter 2.

PRINTED IN U.S.A.

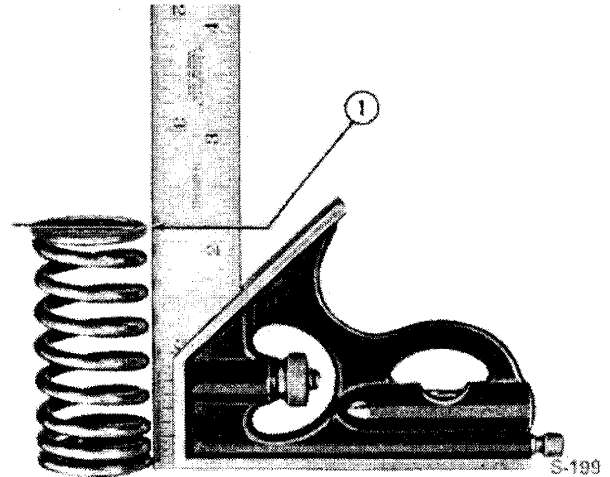

Figure 15
Checking Valve Spring Squareness

1. Maximum Out-Of-Square 0.06 in. (1.5 mm)

ASSEMBLY

CYLINDER HEAD:

1. Insert each valve in the guide bore from which it was removed and lap in position to be sure of an even seat around the valve. Withdraw the valve and remove all traces of lapping compound.
2. Use a valve spring compressor to reassemble the valves, valve springs, retainers and retainer locks. For the exhaust valves install a new sealing ring in the second groove from the top of the valve stem.

THERMOSTAT:

3. Install the thermostat (spring end towards the head), coolant outlet and a new gasket, Figure 5.

ROCKER SHAFT ASSEMBLY:

4. Coat all components with engine oil and position the notch on the front of the rocker shaft upwards to correctly locate the oil holes, Figure 16.
5. Start the assembly from the shaft rear end by securing a rocker arm support with a long bolt. Be sure the notch on the support is positioned to the right of the shaft when looking forward. Proceed to install a spacer, rocker arm, spring, rocker arm and support. Repeat the procedure until complete.

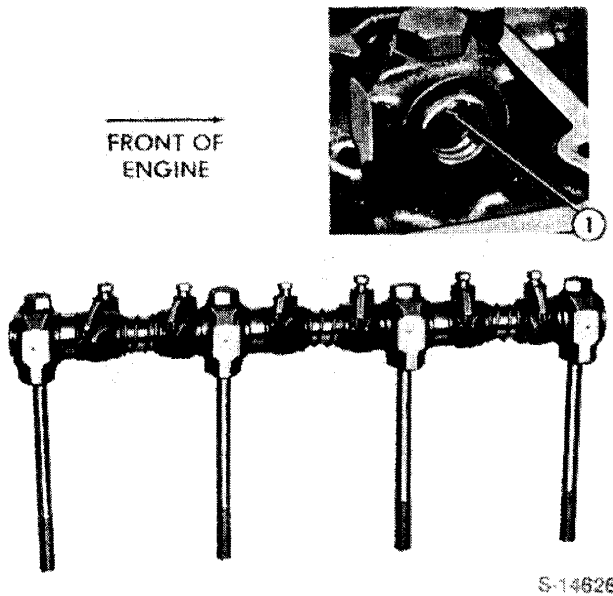

Figure 16
Rocker Shaft Assembly

1. Notch

INSTALLATION

Installation of the cylinder head and related components follows the removal procedure in reverse. On installation observe the following requirements:

- Install new cylinder head, intake and exhaust manifold gaskets.
- Be sure washers are installed under the heads of the cylinder head retaining bolts. Tighten the cylinder head bolts in the sequence shown in Figure 17, and progressively in three steps as follows:
 - (i) Torque to 90 lbs. ft. (122 Nm)
 - (ii) Torque to 100 lbs. ft. (135 Nm)
 - (iii) Torque to 110 lbs. ft. (149 Nm)

NOTE: *The cylinder head bolts should be torqued only when the engine is cold.*

- Rotate the engine and set the valve lash, Figure 18. See "Specifications," Chapter 3.
- Install the injectors with new seat washers and cork seals.
- Install the injector lines and leak-off pipe with new washers.

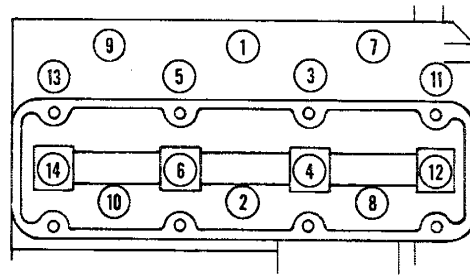

S-20346

Figure 17
Cylinder Head Bolt Tightening Sequence

NOTE: *Hold the leak-off plastic tube securely to prevent pivoting when tightening the banjo fitting bolts to the correct torque. See "Specifications," Chapter 3.*

- Use new lock tabs for the exhaust manifold retaining bolts and bend the tabs to effect retention.
- Tighten all nuts and bolts to the specified torques. See "Specifications," Chapter 3.

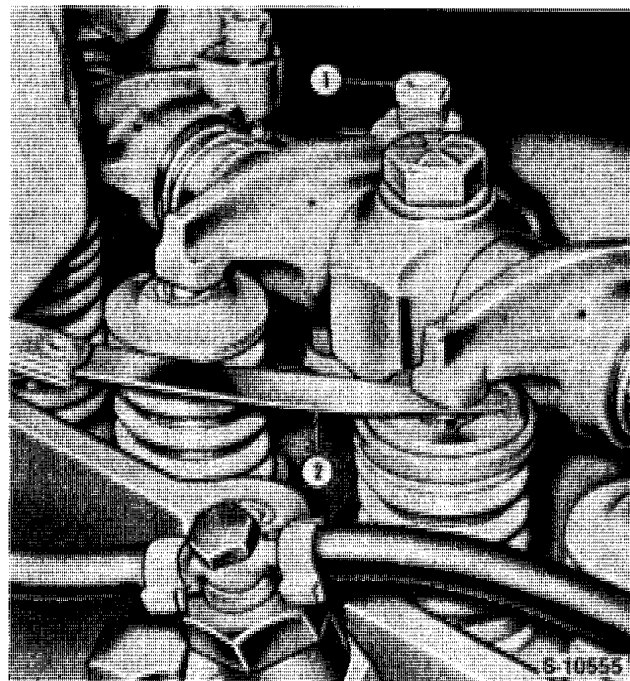

Figure 18
Setting Valve Lash

1. Adjuster Screw
2. Feeler Gauge



Suggest:

If the above button click is invalid.

Please download this document

first, and then click the above link

to download the complete manual.

Thank you so much for reading

ENGINE FRONT COVER AND TIMING GEARS

REMOVAL

NOTE: *The engine front cover and timing gears can only be serviced after removing the radiator and front axle. See "Separating the Tractor," Part 12.*

1. Drain the engine oil and remove the oil pan.
2. Remove the fan drive belt and withdraw the bolt and washer from the center of the crankshaft pulley.
3. Using Puller No. 9539 and Shaft Protector No. 9212, remove the crankshaft pulley, Figure 19.
4. Remove the power steering pump, see "Steering Systems," Part 9.
5. Remove the front cover retaining bolts, front cover and gasket. Remove the oil slinger, Figure 20, from the crankshaft.
6. Before removing the timing gears, use a dial indicator or feeler gauges to measure the backlash between each set of mating gears, Figure 20. Rotate the gears and check the backlash at four equidistant points on the gears. Renew the gears if the backlash exceeds the specified limits, see "Specifications," Chapter 3.
7. Pry the camshaft gear away from the thrust plate and using a dial indicator or feeler gauges, measure the clearance, Figure 21. Install a new camshaft thrust plate if the camshaft end play exceeds the specified limits. See "Specifications," Chapter 3.
8. Remove the fuel injection pump drive gear, camshaft drive gear and adapter and the camshaft gear. Use Tool No. 2134 and 1237 to remove the crankshaft gear, Figure 22.

NOTE: *The crankshaft gear should only be removed if it shows signs of wear.*

INSPECTION AND REPAIR

1. Wash the gears and adapter in a suitable solvent and dry with a clean lint free cloth or compressed air.

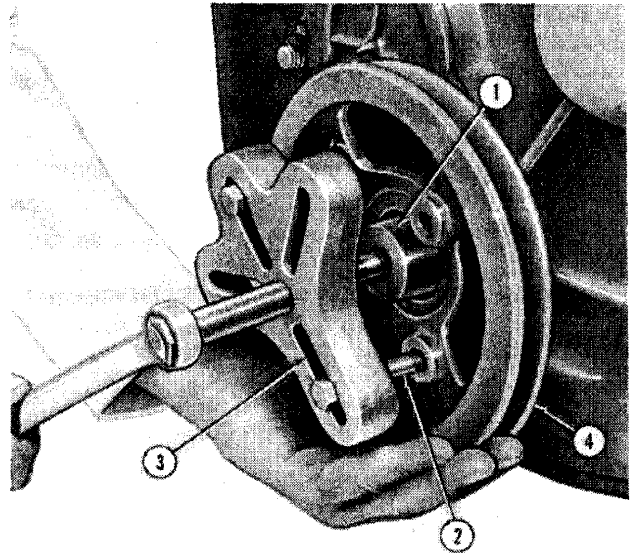

S-205

Figure 19
Crankshaft Pulley Removal

- | | |
|-----------------------------|----------------------|
| 1. Shaft Protector No. 9212 | 3. Puller No. 9539 |
| 2. 7/8 in. x 14 UNC Bolt | 4. Crankshaft Pulley |

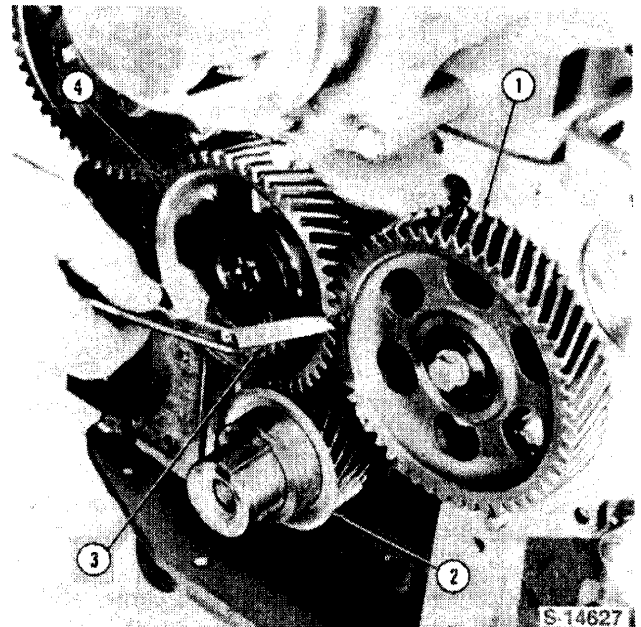

S-14627

Figure 20
Measuring Timing Gear Backlash

- | | |
|------------------|---|
| 1. Camshaft Gear | 3. Feeler Gauge |
| 2. Oil Slinger | 4. Camshaft Drive Gear (Reference Only) |

<https://www.ebooklibonline.com>

Hello dear friend!

Thank you very much for reading.

Enter the link into your browser.

The full manual is available for immediate download.

<https://www.ebooklibonline.com>