

Section: ENGINE
CRANKCASE

Fig.	P/n	QTY	Name
------	-----	-----	------

Notes:
[EXPLORER 80 SPECIAL]

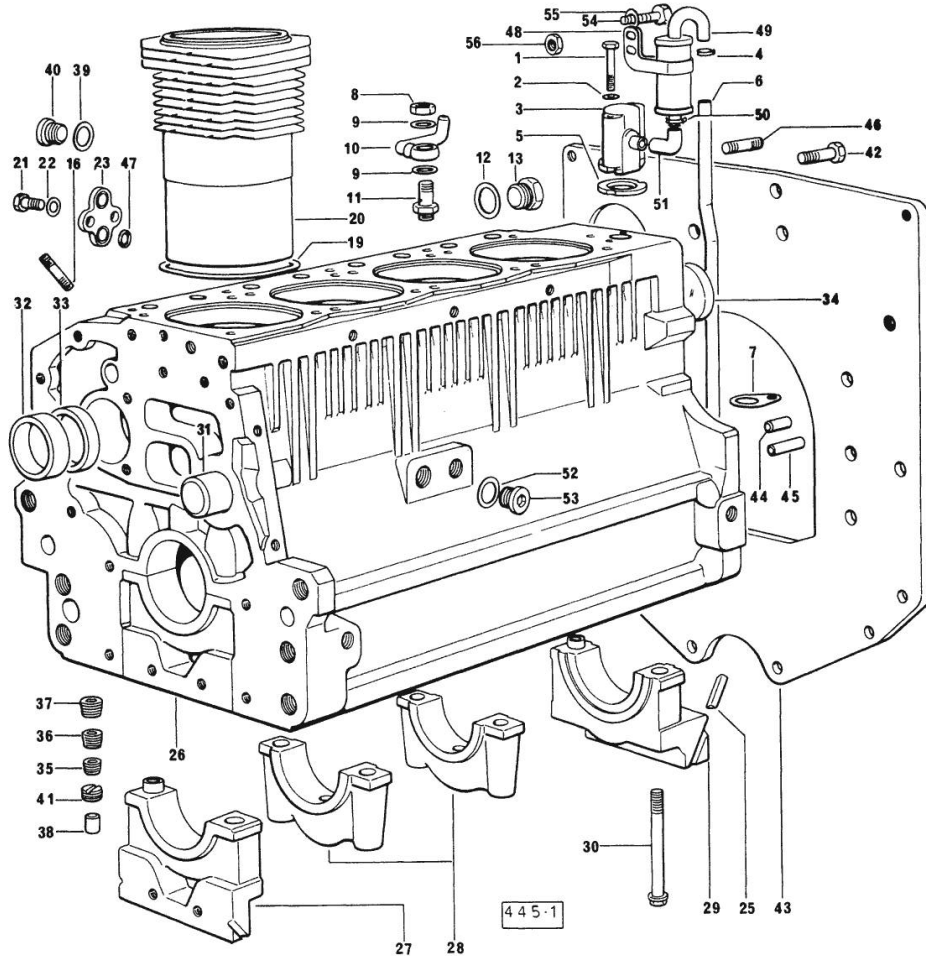

0	0.065.0050.6	1	gasket set FOR ENGINE ASSEMBLY 916.4 A
0	0.086.0050.6	1	gasket set FOR 1000.4A ENGINE ASSEMBLY
1	2.0312.219.2	2	screw m 8 p.1.25x65
2	2.1470.004.2	2	lock washer 8
3	0.065.1143.3/10	1	body
4	2.6859.072.2	1	clamp
5	0.065.1156.0	2	gasket
6	0.065.1155.0/10	1	tube
7	0.065.1157.0	1	bracket
8	2.1099.108.2	4	special nut m 10 p.1
9	2.1560.006.0	8	gasket 10.2 x 16
10	0.065.1158.2	4	old part number X 916.4 A
10	0.086.1550.2	4	sprayer nozzle X 1000.4 A
11	0.065.1160.3/20	4	valve
12	2.1539.047.2	1	old part number
13	2.3199.405.2	1	plug m 28 p.1.5
16	2.0439.154.1	12	old part number
19	2.1519.096.0	4	oil seal X 1000.4 A
19	2.1589.154.0	1	shoulder ring X 916.4 A
19	2.1589.155.0	4	shoulder ring X 916.4 A
19	2.1589.156.0	4	shoulder ring X 916.4 A
20	0.007.0762.0/30	4	engine cylinder -> 26013
20	0.065.1120.0/10	4	engine cylinder X 916.4 A
20	0.085.1120.0	4	old part number 26012 <- X 1000.4 A
21	2.0112.207.2	2	screw m 8 p 1.25 x 20
22	2.1470.004.2	2	lock washer 8
23	0.065.1163.0	1	flange
25	0.066.1152.0	4	gasket
26	0.065.1110.4/20	1	crankcase X 916.4 A

Section: ENGINE
CRANKCASE

Fig.	P/n	QTY	Name
26	0.086.1110.4	1	crankcase X 1000.4 A
27	0.065.1112.7	1	support
27	2.1699.165.0	1	bush 12.3x15x16
28	0.065.1114.7	3	support
29	0.065.1116.7	1	support
29	2.1699.165.0	1	bush 12.3x15x16
30	0.065.1117.0	10	screw m 12 x 100
31	0.066.1151.0	1	pin
32	0.065.1141.0	1	special bushing 59X55X30
33	0.065.1140.0	4	special bushing 59X55X20
34	2.3179.012.0	1	plug 60
35	2.3130.001.1	10	plug 1/8" gas
36	2.3130.002.1	2	plug 1/4" gas
37	2.3130.003.1	7	plug 3/8" gas
38	2.3199.092.0	4	plug 8 x 12
39	2.1560.017.0	1	gasket 22.2 x 27
40	2.3120.002.4	1	plug m 22 x 1.5
41	2.1324.011.0	1	plug
42	2.0112.511.2	8	screw m 14 p.2 x 30
43	0.066.1130.0/10	1	old part number
44	2.1651.912.0	2	cylindrical plug 12x28
45	2.1651.917.0	1	cylindrical plug 12x40
46	2.0432.255.1	2	stud bolt m 12 p.1.75 - 12 p1.25x25
47	2.1539.048.0	2	special oil seal 20.35x1.78
48	2.6859.074.2/10	1	clamp
49	0.065.1165.2	1	sediment bowl
50	2.6859.073.2	2	clamp
51	0.065.1166.0	1	sleeve
52	2.1560.017.0	1	gasket 22.2 x 27
53	2.3120.002.4	1	plug m 22 x 1.5
54	2.0112.004.2	1	screw m 6 p.1 x 14
55	2.1470.002.2	1	lock washer 6
56	2.1011.103.2	1	nut m 6 p.1

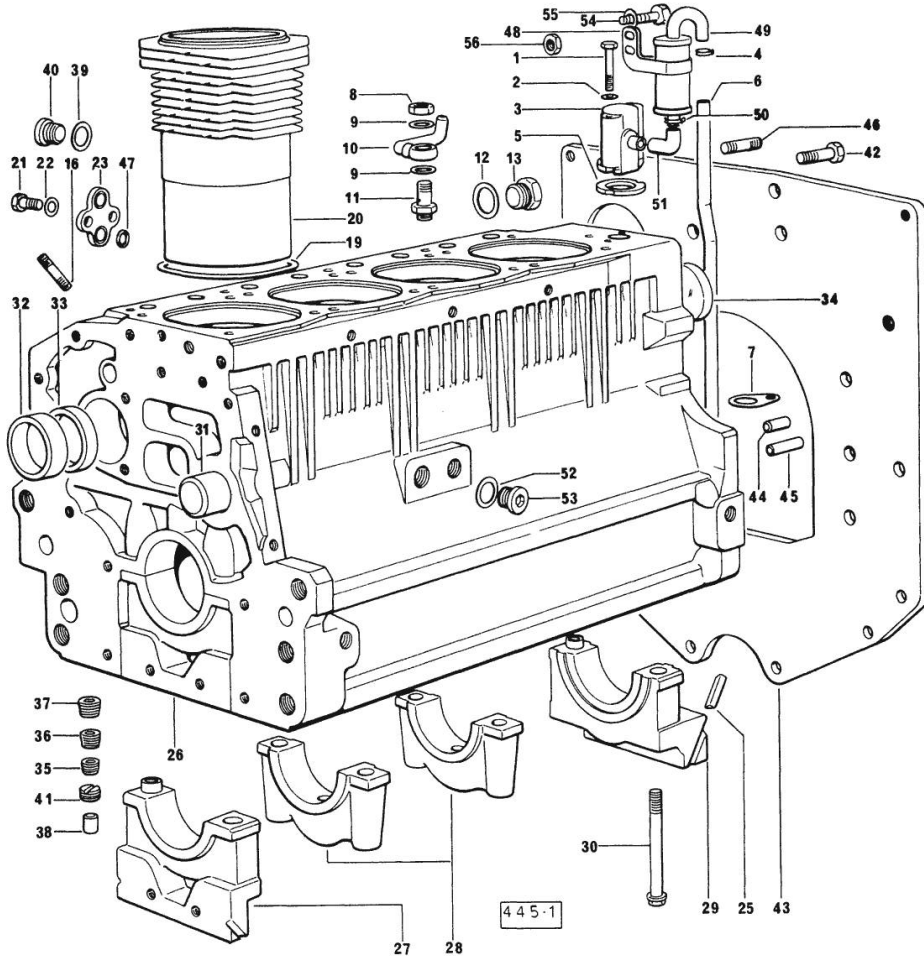

Section: ENGINE

TIMING CASE

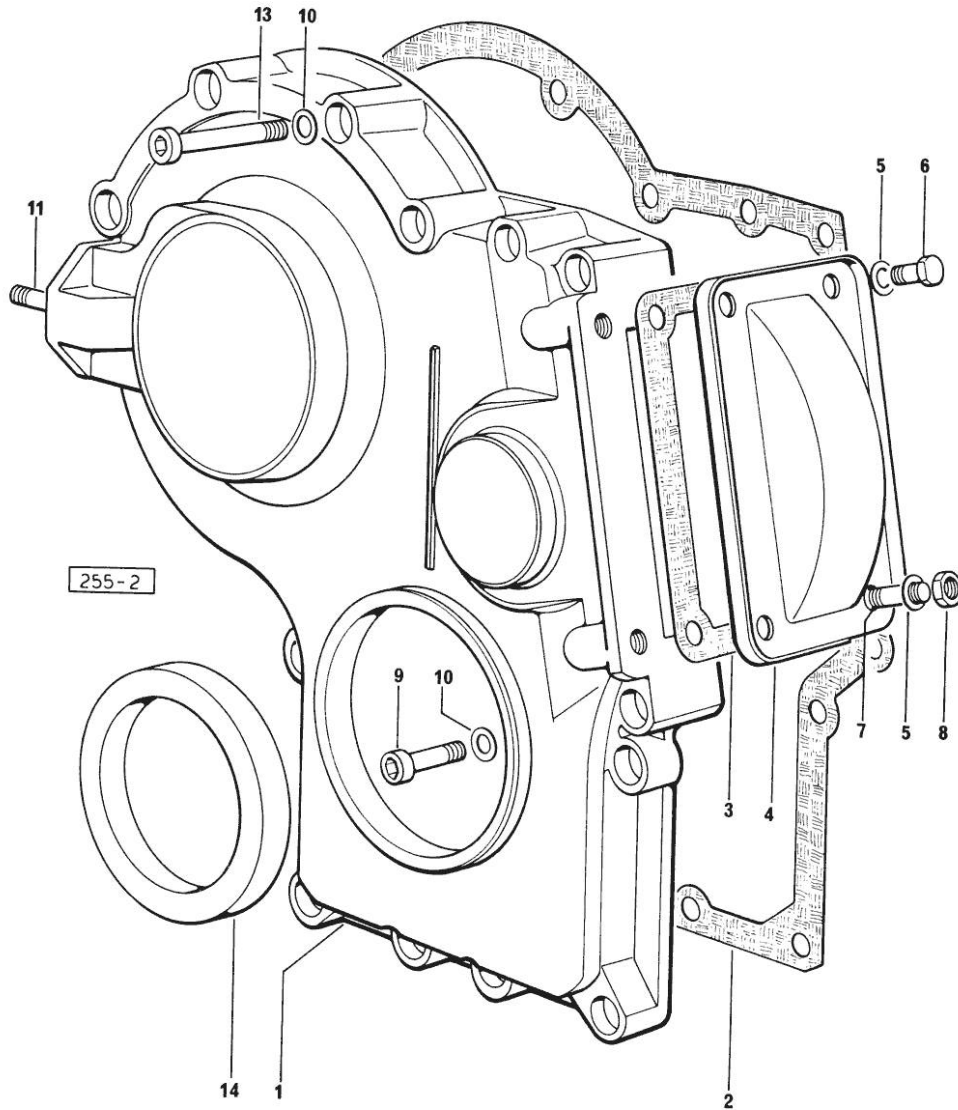

Fig.	P/n	QTY	Name
------	-----	-----	------

Notes:
[EXPLORER 80 SPECIAL]

1	0.065.1132.0/20	1	guard
2	0.065.1150.0/10	1	gasket
3	0.065.1152.0	1	gasket
4	0.065.1151.0	1	cover
5	2.1470.004.2	4	lock washer 8
6	2.0112.205.2	2	screw m 8 p.1.25 x 16
7	2.0432.003.7	2	stud bolt m 8 p.1.25 / p.1 x 20
8	2.1011.405.2	2	nut m 8 p.1
9	2.0312.208.1	8	screw m 8 p.1.25 x 25
10	2.1480.014.1	15	washer 8
11	2.0439.154.2	2	stud bolt m 8 p.1x20
13	2.0312.214.2	3	screw m 8 p.1.25 x 40
13	2.0312.219.2	4	screw m 8 p.1.25x65
14	2.1529.072.0	1	oil seal

<https://www.ebooklibonline.com>

Hello dear friend!

Thank you very much for reading.

Enter the link into your browser.

The full manual is available for immediate download.

<https://www.ebooklibonline.com>

Section: ENGINE

CRANKSHAFT

Fig.	P/n	QTY	Name
------	-----	-----	------

Notes:

[EXPLORER 80 SPECIAL]

1	0.066.1210.3/20	1	crankshaft X 916.4 A
1	0.086.1210.3	1	crankshaft X 1000.4 A
2	0.065.1211.0/10	1	crown wheel
3	2.1630.608.0	1	pin 6x16
4	2.3130.001.1	4	plug 1/8" gas
5	0.065.1220.3/10	4	engine connecting rod X 916.4 A
5	0.078.1220.3/10	4	engine connecting rod - X 1000.4 W X 1000.4 A
6	2.0139.021.0	8	screw
7	0.065.1227.0	4	special bushing
8	2.1411.013.1	8	circlip 32 X 916.4 A
8	2.1411.014.1	8	circlip 35 X 1000.4 A
9	0.065.1236.0	4	piston pin X 916.4 A
9	0.078.1236.0	4	piston pin Ø 18 / Ø 35 / L = mm 86 X 1000.4 A
10	2.1720.006.0	1	key 4x6.5
11	0.065.1248.0/10	1	hub
12	2.1589.136.0	1	shoulder ring 71x110x0.5
12	2.1589.137.0	1	shoulder ring 71x110x1
13	2.0399.095.2/10	1	screw
14	2.1599.503.2	1	shoulder ring
15	2.0112.317.2	6	screw m 10 p.1.5 x 45
16	2.1470.006.2	6	lock washer 10
17	0.065.1244.0	1	pulley
18	0.065.1254.0	1	gasket
19	0.065.1253.0/10	1	cover
20	2.1529.073.0	1	special oil seal 110x130x13
21	2.0112.207.2	9	screw m 8 p 1.25 x 20
22	2.1474.009.1	9	spring washer 8
23	0.065.1225.0	8	con.rod half bushing STANDARD - A = 28.75 -> 29.00
24	0.065.1215.0	5	main half bushing STANDARD
25	0.065.1216.0	5	main half bushing
26	0.065.1218.0	4	shim STANDARD
27	0.065.0060.6	4	complete piston X 916.4 A

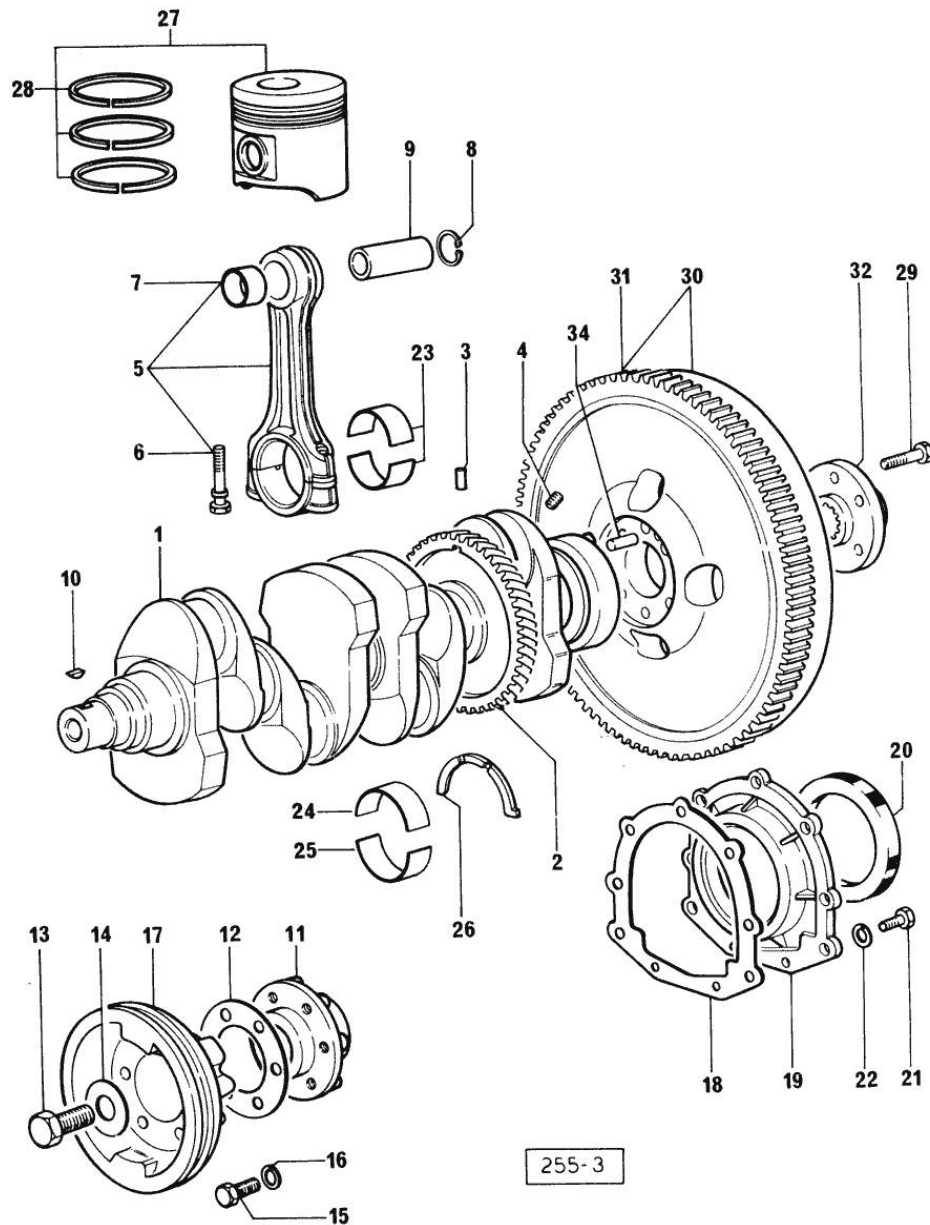

Section: ENGINE
CRANKSHAFT

Fig.	P/n	QTY	Name
27	0.085.0060.6	4	complete piston X 1000.4 A
28	0.065.0052.6	4	piston ring set X 916.4 A
28	0.085.0052.6	4	piston ring set X 1000.4 A
29	2.0139.022.2	6	screw m 12 p.1.25x55
30	0.076.1247.3	1	old part number
31	0.065.1242.0	1	crown wheel Z = 123
32	0.255.2525.0/10	1	flange
34	2.1652.915.0	1	cylindrical plug 12x35

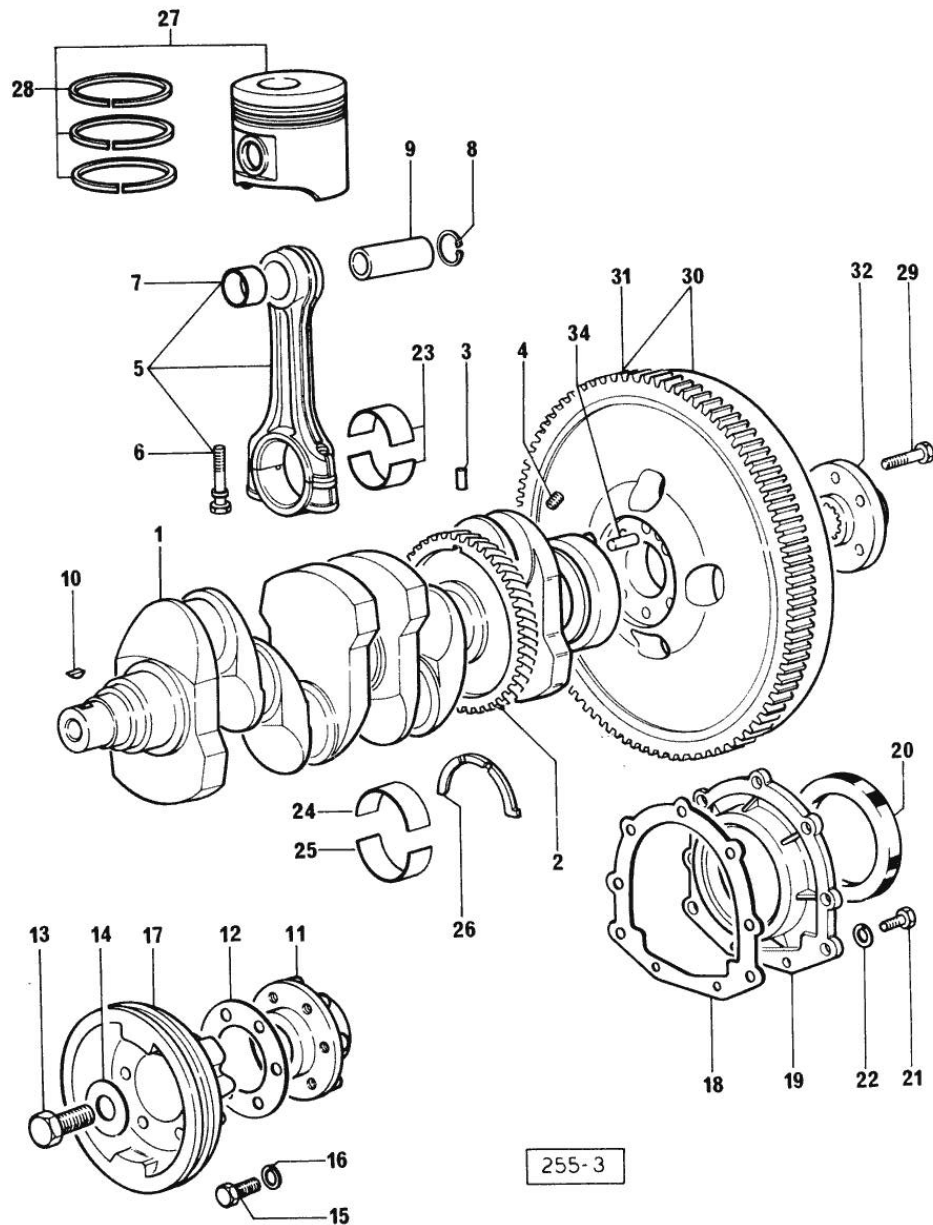

Section: ENGINE
COUNTERWEIGHTS

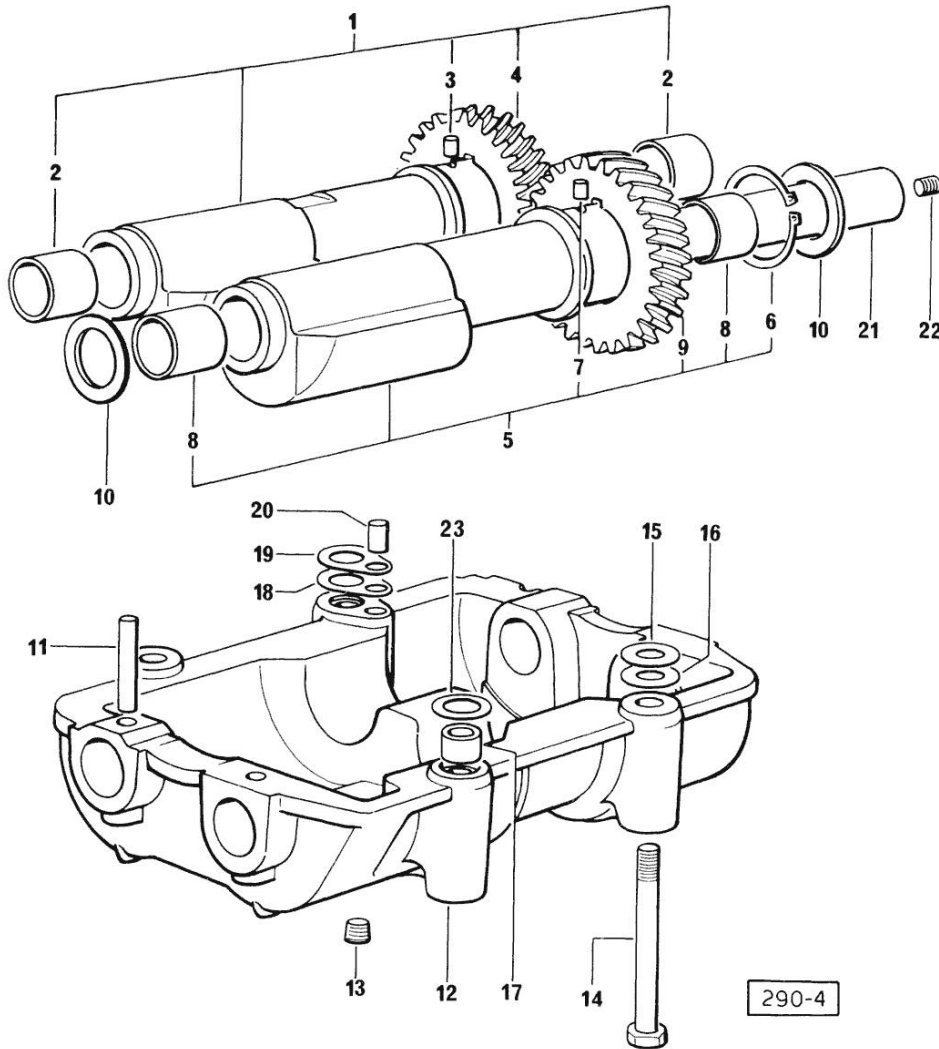

Fig.	P/n	QTY	Name
Notes: [EXPLORER 80 SPECIAL]			
1	0.065.1232.3/20	1	old part number X 916.4 A
1	0.086.1233.3	1	mass X 1000.4 A
2	2.1559.115.0	2	special bushing 26x30x30
3	2.1652.302.0	1	roll pin 4x6
4	0.065.1237.0	1	old part number
5	0.065.1233.3/10	1	mass
6	2.1410.018.1	1	circlip 45
7	2.1652.302.0	1	roll pin 4x6
8	2.1559.115.0	2	special bushing 26x30x30
9	0.065.1238.0	1	gear
10	2.1589.050.0/10	4	shoulder ring 26.1x38x1 X 916.4 A
10	2.1589.185.0	4	shoulder ring 26.1x34x1 X 1000.4 A
11	2.1631.717.0	2	roll pin 8 x 40
12	0.065.1231.3/20	1	old part number X 916.4 A
12	0.086.1231.3	1	old part number X 1000.4 A
13	2.3130.001.1	4	plug 1/8" gas
14	2.0112.427.2	3	screw m 12 p.1.75 x 90
15	2.1589.049.0	1	shoulder ring 12.5x26x0.3
16	2.1579.629.0	1	spacer 12.5x26x0.1
17	2.1579.626.0	2	spacer 13.2x16x11
18	2.1589.139.0	2	shoulder ring mm 0.3
19	2.1589.140.0	2	shoulder ring mm 0.1
20	2.1699.191.0	1	bush 7x10x16
21	0.065.1234.3	2	old part number
22	2.3130.001.1	2	plug 1/8" gas
23	2.1579.628.0	2	spacer 16.5x26x0.1
23	2.1589.048.0	2	shoulder ring 16.5x26x0.3

Section: ENGINE

CAMSHAFT

Fig.	P/n	QTY	Name
------	-----	-----	------

Notes:
[EXPLORER 80 SPECIAL]

1	0.065.1324.0	1	gear
1	0.066.1310.3/10	1	old part number
2	0.065.1353.0	1	small plate
3	2.0312.205.2	2	screw
4	2.1480.014.1	2	washer 8
5	065.1323.0/20	1	-
6	065.1325.3/20	1	-
6	2.1559.185.0	1	special bushing
7	065.1351.0	2	-
8	0.065.1352.0	1	shim
9	2.1410.016.1	1	circlip 40
10	0.065.1354.0/10	1	gear z=58
11	0.065.1350.0	1	small disc
12	2.0132.207.2	4	screw m 10 p.1 x 25
13	0.065.1330.0	8	tappets
14	2.1569.114.0	16	gasket
15	2.1599.437.0	8	shoulder ring
16	2.4019.300.1	8	spring
17	0.065.1332.0	8	sleeve
18	0.065.1331.2	8	rod

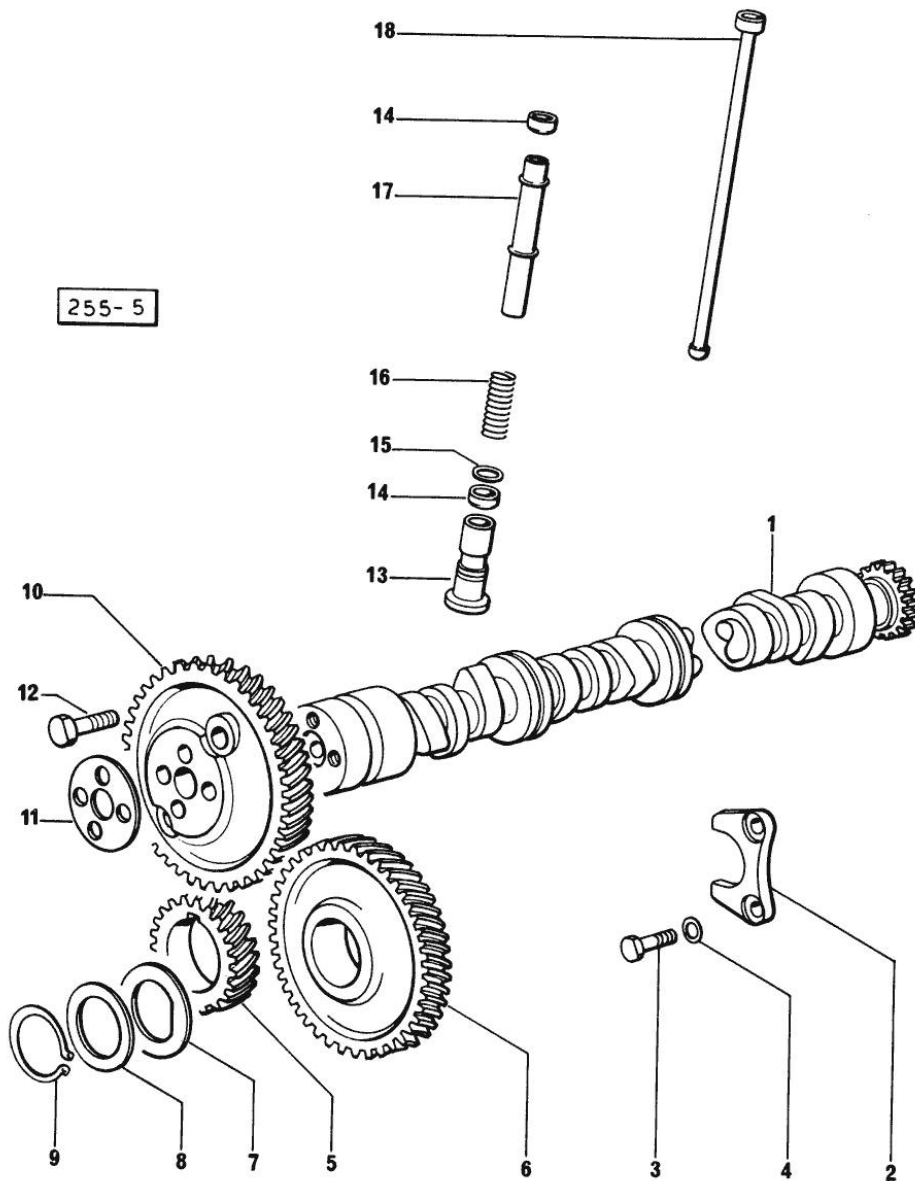

Section: ENGINE
CYLINDER HEAD

Fig.	P/n	QTY	Name
------	-----	-----	------

Notes:
[EXPLORER 80 SPECIAL]

0	0.065.0057.6	4	gasket set - FOR 1 CYLINDER VALVE GRINDING AND PISTON RINGS REPLACEMEN - X 916.4 A
0	0.085.0057.6	4	gasket set - FOR 1 CYLINDER VALVE GRINDING AND PISTON RINGS REPLACEMEN - X 1000.4 A
1	2.0112.211.2	4	screw m 8 p.1.25 x 30
2	2.1560.204.0	4	gasket
3	0.066.1440.0/10	4	small cap
4	0.065.1450.0/10	1	gasket
4	0.066.1450.0	4	tappet gasket
5	2.1011.421.2	8	nut m 10 p.1.25
6	2.0432.163.7	8	stud bolt m 10 p.1.5 / p.1.25 x 45
7	0.066.1430.0	4	support
8	0.066.1432.0	8	rocker arm
9	2.1599.432.0	8	shoulder ring
10	2.1410.055.1	8	circlip 19
11	2.1011.405.2	8	nut m 8 p.1
12	0.021.1434.0	8	screw
13	0.074.1423.0	8	conical valve cotter
14	0.066.1425.0	8	cup
15	2.4019.287.0	8	spring
16	0.065.1413.0/10	4	bush L = mm 97.1
17	2.0432.161.7	4	stud bolt m 10 p.1.5 / p.1.25 x 40
18	0.065.1443.0/10	16	screw
20	2.0432.007.7	8	stud bolt m 8 p.1.25 / p.1 x 30
21	0.085.1450.0	4	head gasket mm 0.5 -A- X 1000.4 A
21	0.085.1451.0	4	head gasket mm 0.7 -B- X 1000.4 A
21	0.085.1452.0	4	head gasket mm 1.0 -C- X 1000.4 A
21	0.085.1453.0	4	head gasket mm 0.8 -D- X 1000.4 A
21	2.1569.112.0	4	gasket X 916.4 A
22	0.066.1421.0	4	exhaust valve
23	0.066.1420.0	4	inlet valve Ø mm 9 X 916.4 A

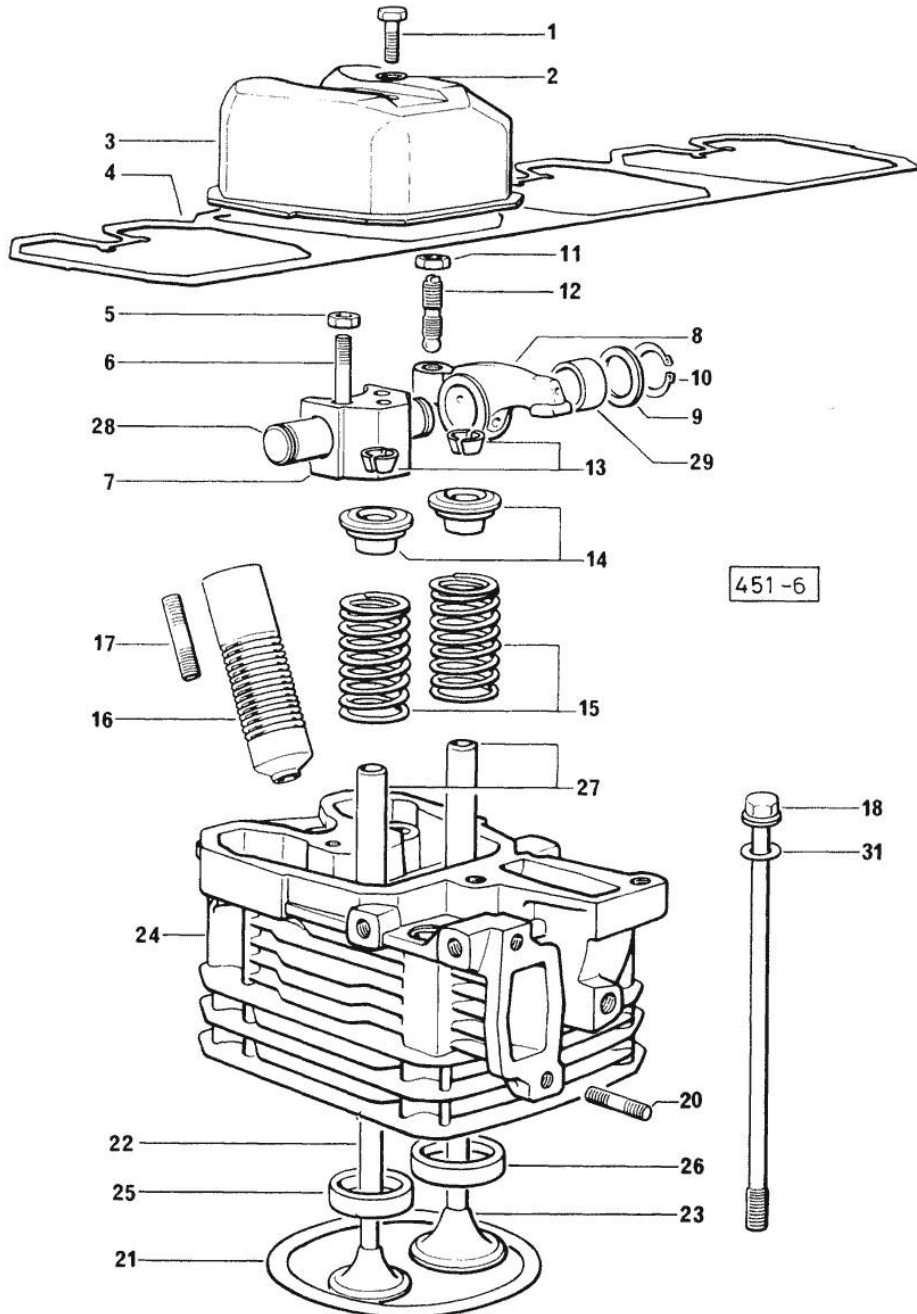

Section: ENGINE
CYLINDER HEAD

Fig.	P/n	QTY	Name
23	0.081.1420.0	4	inlet valve Ø mm 9 X 1000.4 A
24	0.065.1410.3/10	4	engine head X 916.4 A
24	0.081.1410.3	4	engine head X 1000.4 A
25	0.066.1427.0	4	valve seat
26	0.066.1426.0	4	valve seat X 916.4 A
26	0.078.1426.0	4	valve seat X 1000.4 A
27	0.066.1416.0	8	valve guide
28	0.066.1431.0	4	pin
29	2.1559.021.0/40	8	bushing 15x19x22
31	2.1599.434.0	16	shoulder ring

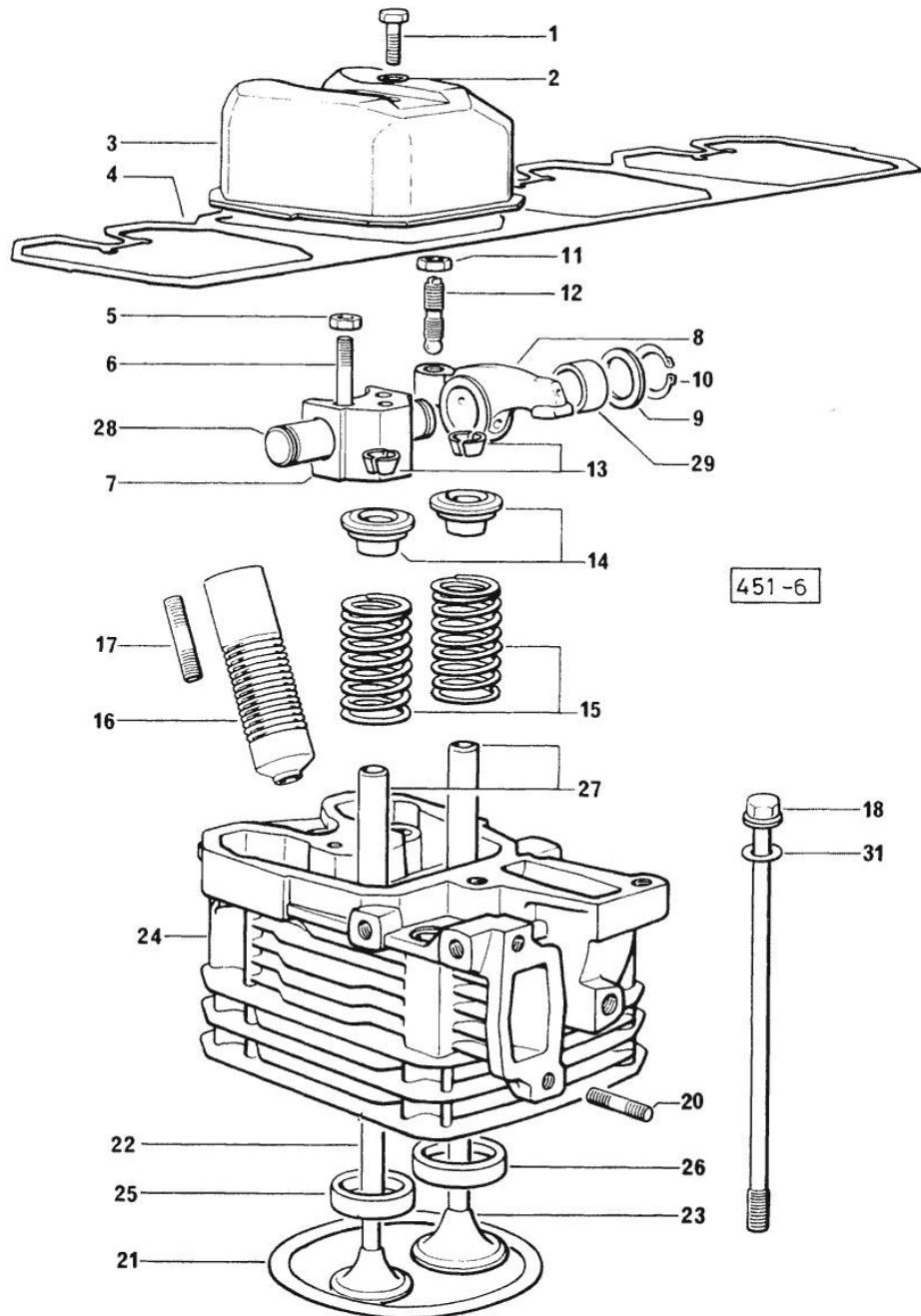



Suggest:

For more complete manuals. Please go to the home page.

<https://www.ebooklibonline.com>

If the above button click is invalid. Please download this document first, and then click the above link to download the complete manual.

Thank you so much for reading

Section: ENGINE
LUBRICATION

Fig.	P/n	QTY	Name
------	-----	-----	------

Notes:
[EXPLORER 80 SPECIAL]

1	0.065.1510.0/20	1	oil sump
2	0.065.1550.0	1	gasket
3	2.3199.001.2	1	plug 1/2" gas
4	2.1560.054.0	1	gasket 21 x 26
5	2.0112.227.2	6	screw m 8 p.1.25 x 90
5	2.0112.235.2	3	screw m 8 p.1.25 x 130
6	2.0112.215.2	17	screw m 8 p.1.25 x 40
7	2.1470.004.2	26	lock washer 8
8	0.065.1531.3	1	tube
9	2.0112.205.2	1	screw m 8 p.1.25 x 16
10	2.1011.105.2	1	nut m 8 p.1.25
11	2.1470.004.2	2	lock washer 8
12	0.065.1538.0	1	flange
13	2.1539.040.0	1	special oil seal 21.82 x 3.53
14	2.0312.216.1	2	screw
15	2.1480.014.1	4	washer 8
16	0.077.1540.3/10	1	old part number
17	2.1539.048.0	2	special oil seal 20.35x1.78
18	0.066.1513.2	1	dipstick
19	2.1539.065.0	2	special oil seal 8.73 x 1.78
20	0.066.1551.0	1	spacer
23	0.044.1567.0	1	oil filter element
24	2.3339.307.1/20	1	pipe fitting
25	2.3339.353.2	1	pipe fitting
26	2.1560.014.0	1	washer 18.2 x 24
27	2.0399.125.2/10	2	screw m 8 x 55

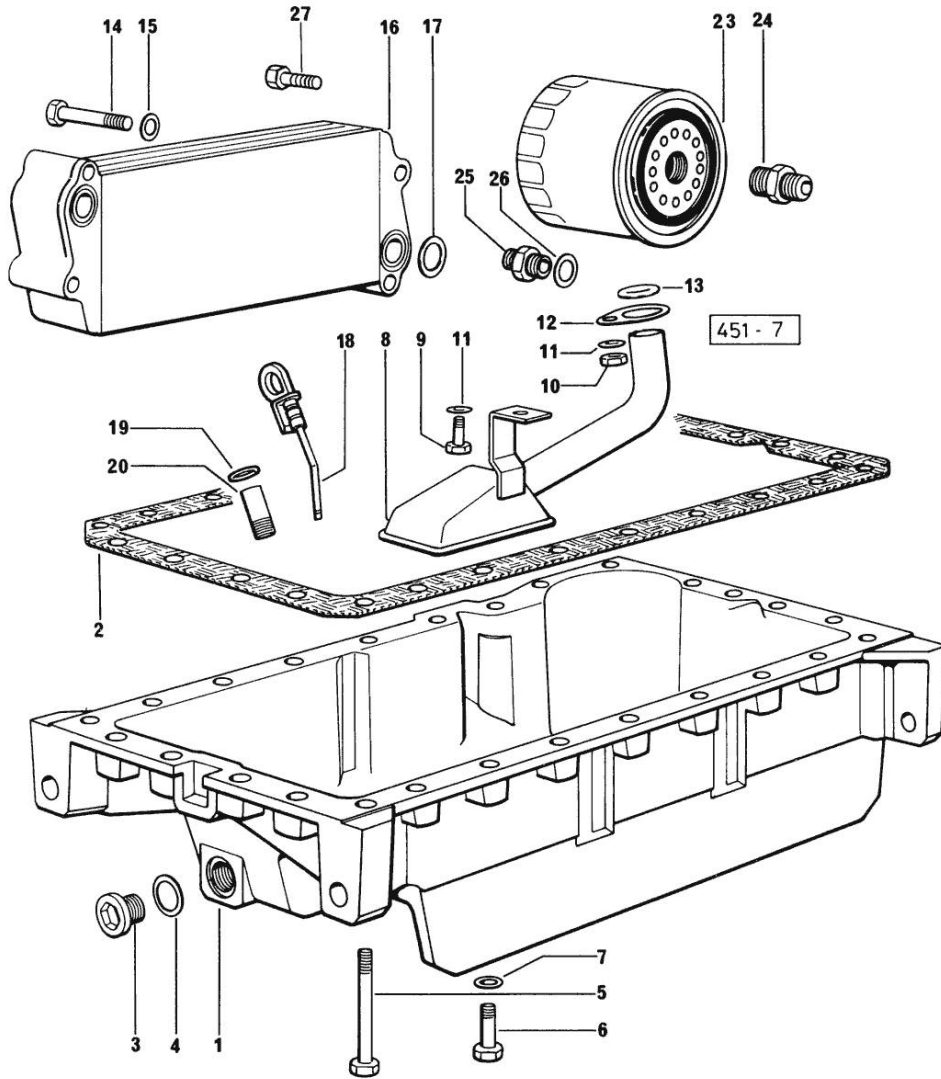

Section: ENGINE
LUBRICATION

Fig.	P/n	QTY	Name
------	-----	-----	------

Notes:
[EXPLORER 80 SPECIAL]

1	0.065.1510.0/20	1	oil sump
2	0.065.1550.0	1	gasket
3	2.3199.001.2	1	plug 1/2" gas
4	2.1560.054.0	1	gasket 21 x 26
5	2.0112.227.2	6	screw m 8 p.1.25 x 90
5	2.0112.235.2	3	screw m 8 p.1.25 x 130
6	2.0112.215.2	17	screw m 8 p.1.25 x 40
7	2.1470.004.2	26	lock washer 8
8	0.065.1531.3	1	tube
9	2.0112.205.2	1	screw m 8 p.1.25 x 16
10	2.1011.105.2	1	nut m 8 p.1.25
11	2.1470.004.2	2	lock washer 8
12	0.065.1538.0	1	flange
13	2.1539.040.0	1	special oil seal 21.82 x 3.53
14	2.0312.216.1	2	screw
15	2.1310.004.2	4	flat washer 8.4x17
16	0.077.1540.3/10	1	old part number
17	2.1539.048.0	2	special oil seal 20.35x1.78
18	0.066.1513.2/10	1	dipstick mm 106 - WITH SPACER
18	0.086.1513.2	1	dipstick WITHOUT SPACER
19	2.1539.065.0	2	special oil seal 8.73 x 1.78
20	0.066.1551.0	1	spacer
23	0.044.1567.0	1	oil filter element
24	2.3339.307.1/20	1	pipe fitting
25	2.3339.353.2	1	pipe fitting
26	2.1560.014.0	1	washer 18.2 x 24
27	2.0399.125.2/10	2	screw m 8 x 55

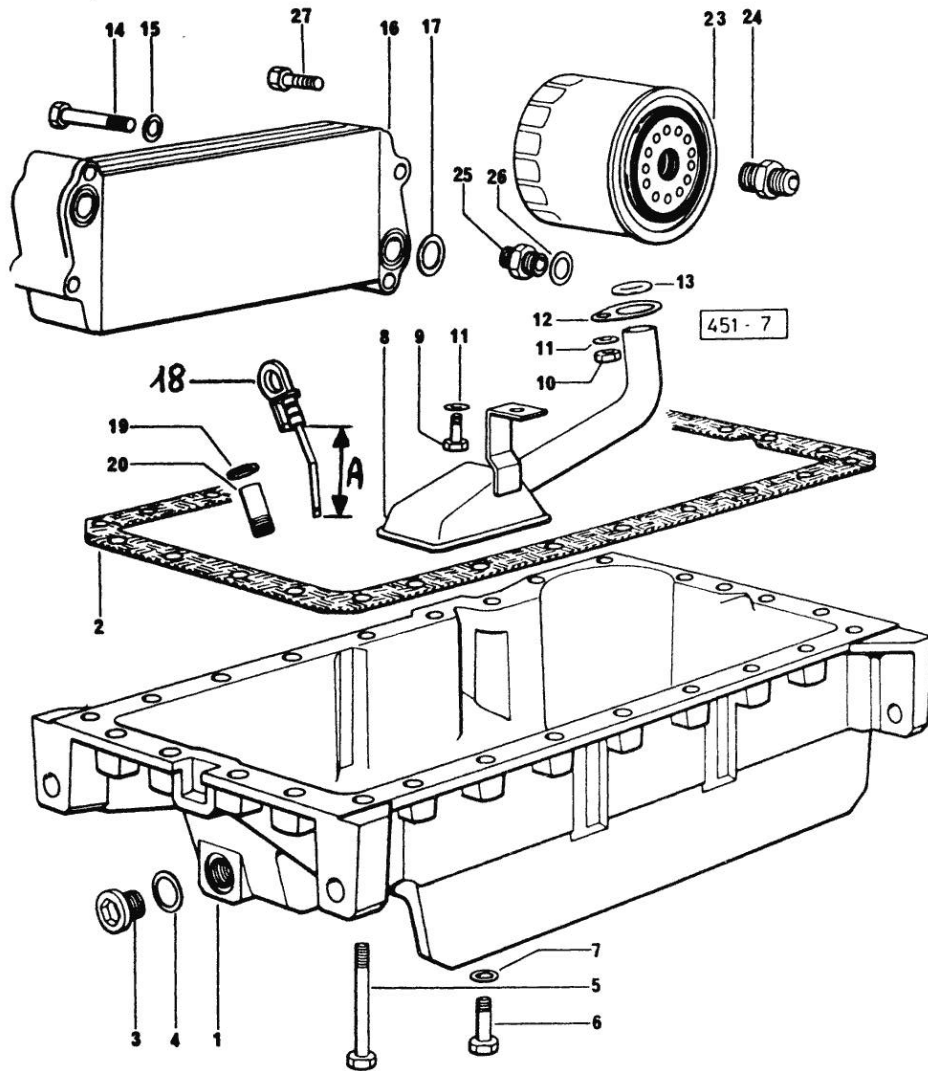

<https://www.ebooklibonline.com>

Hello dear friend!

Thank you very much for reading.

Enter the link into your browser.

The full manual is available for immediate download.

<https://www.ebooklibonline.com>