

ENGINE TYPE-APPROVAL DATA PLATE

Fig.	P/n	QTY	Name
------	-----	-----	------

Notes:

[XV90 -> ZKDP7502W0TH01001]

1	0.000.0000.1		cannot be supplied MADE BY TREVIGLIO ITALY
2	0.000.0000.1		cannot be supplied MADE AT RANIPET - INDIA



9_STA000_00_0-A-001

CRANKCASE

Fig.	P/n	QTY	Name
------	-----	-----	------

Notes:

FOR ENGINES PRODUCED IN : TREVIGLIO ITALY [XV90 -> ZKDP7502W0TH01001]



9_O1011_00_0-A-001

3	2.3199.312.2/20	1	plug m 35x1.5x9.5
5	2.0439.279.7	8	stud bolt m 8 p.1 x 25
6	2.1559.188.2	4	bush 11.4 x 14 x16
7	2.1539.259.0	8	special oil seal 107.62x2.62
8	2.1560.010.0	1	gasket 14.2 x 20
9	2.3199.292.0	1	plug 1/4" gas
10	0.014.9655.4/30	1	crankcase
10.1	2.3130.001.1	14	plug 1/8" gas
10.2	2.3130.002.1	4	plug 1/4" gas
10.3	2.3130.003.1	6	plug 3/8" gas
10.4.1.1.1	0.065.1112.7/10	1	support
10.4.1.2	2.1699.165.0	1	bush 12.3x15x16
10.4.2	0.065.1114.0/10	3	support
10.4.3	0.065.1116.3	1	support
10.4.3.2	2.1699.165.0	1	bush 12.3x15x16
10.4.8	0.065.1117.0	10	screw m 12 x 100
10.5	2.3179.012.0	1	plug 60
10.6	0.065.1140.0	4	special bushing 59X55X20
10.7	0.065.1141.0	1	special bushing 59X55X30
10.8	0.014.1340.0/10	1	pin mm 85
11	0.066.1152.0/10	4	gasket
13	2.1549.154.2	4	bush 4.8x5.8x16
25	0.013.4946.0/10	1	sprayer nozzle
26	2.3120.101.0	1	plug m 18 p.1.5
28	2.1560.014.0	1	washer 18.2 x 24

CRANKCASE

Fig.	P/n	QTY	Name
------	-----	-----	------

Notes:

FOR ENGINES PRODUCED IN : RANIPET - INDIA [XV90 -> ZKDP7502W0TH01001]

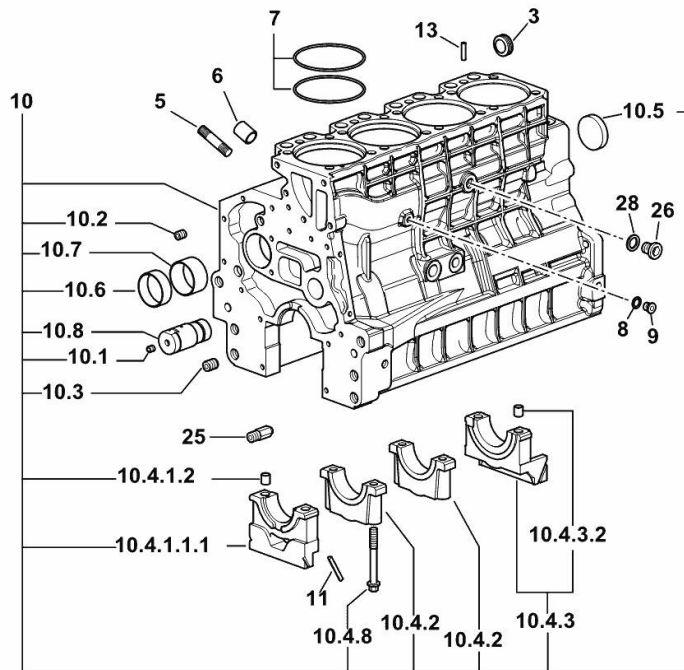

19_O1011_00_0-A-001

3	2.3199.312.2/20	1	plug m 35x1.5x9.5
5	2.0439.279.7	8	stud bolt m 8 p.1 x 25
6	2.1559.188.2	4	bush 11.4 x 14 x16
7	2.1539.259.0	8	special oil seal 107.62x2.62
8	2.1560.010.0	1	gasket 14.2 x 20
9	2.3199.292.0	1	plug 1/4" gas
10	0.014.9655.4/30	1	crankcase
10.1	2.3130.001.1	14	plug 1/8" gas
10.2	2.3130.002.1	4	plug 1/4" gas
10.3	2.3130.003.1	6	plug 3/8" gas
10.4.1.1.1	0.065.1112.7/10	1	support
10.4.1.2	2.1699.165.0	1	bush 12.3x15x16
10.4.2	0.065.1114.0/10	3	support
10.4.3	0.065.1116.3	1	support
10.4.3.2	2.1699.165.0	1	bush 12.3x15x16
10.4.8	0.065.1117.0	10	screw m 12 x 100
10.5	2.3179.012.0	1	plug 60
10.6	0.065.1140.0	4	special bushing 59X55X20
10.7	0.065.1141.0	1	special bushing 59X55X30
10.8	0.014.1340.0/10	1	pin mm 85
11	0.066.1152.0/10	4	gasket
13	2.1549.154.2	4	bush 4.8x5.8x16
25	0.013.4946.0/10	1	sprayer nozzle
26	2.3120.101.0	1	plug m 18 p.1.5
28	2.1560.014.0	1	washer 18.2 x 24

<https://www.ebooklibonline.com>

Hello dear friend!

Thank you very much for reading.

Enter the link into your browser.

The full manual is available for immediate download.

<https://www.ebooklibonline.com>

MONOBLOC ENGINE-GEARBOX CONNECTING FLANGE

Fig.	P/n	QTY	Name
------	-----	-----	------

Notes:

FOR ENGINES PRODUCED IN : TREVIGLIO ITALY [XV90 -> ZKDP7502W0TH01001]

1	0.007.1882.0/50	1	flange
2	2.0112.511.2	8	screw m 14 p.2 x 30
3	2.1651.912.0	2	cylindrical plug 12x28
4	2.1651.917.0	1	cylindrical plug 12x40
5	2.0432.257.7	1	stud bolt m 12 p.1.75 - 1.25 x 30
6	2.0439.250.7	1	stud bolt m 12 / m 10 x 30
7	0.011.9294.0/10	1	bush

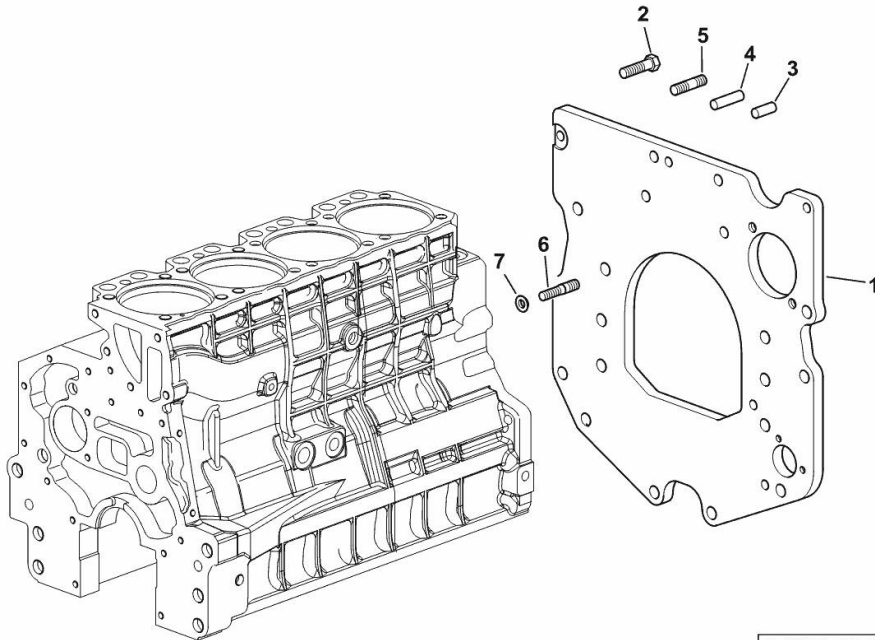

9_38611_01_0-A-001

MONOBLOC ENGINE-GEARBOX CONNECTING FLANGE

Fig.	P/n	QTY	Name
------	-----	-----	------

Notes:

FOR ENGINES PRODUCED IN : RANIPET - INDIA [XV90 -> ZKDP7502W0TH01001]

1	0.007.1882.0/50	1	flange
2	2.0112.511.2	8	screw m 14 p.2 x 30
3	2.1651.912.0	2	cylindrical plug 12x28
4	2.1651.917.0	1	cylindrical plug 12x40
5	2.0432.257.7	1	stud bolt m 12 p.1.75 - 1.25 x 30
6	2.0439.250.7	1	stud bolt m 12 / m 10 x 30
7	0.011.9294.0/10	1	bush

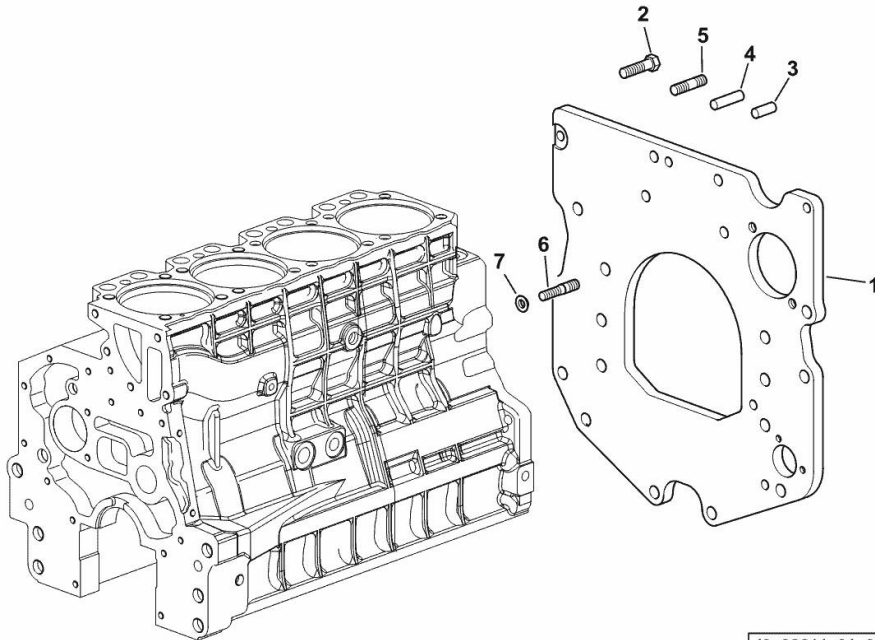

I9_38611_01_0-A-001

ENGINE OIL AND TURBO PRESSURE SWITCH UNION

Fig.	P/n	QTY	Name
------	-----	-----	------

Notes:

FOR ENGINES PRODUCED IN : TREVIGLIO ITALY [XV90 -> ZKDP7502W0TH01001]

10	2.3339.787.0/10	1	pipe fitting 7/16"
11	2.3110.403.1	1	plug m 14 p.1.5x12
13	2.1019.129.2/10	1	nut m 18 p.1.5x12
14	2.1533.038.0	1	oil seal 15.45x2.62
15	2.1560.010.0	2	gasket 14.2 x 20

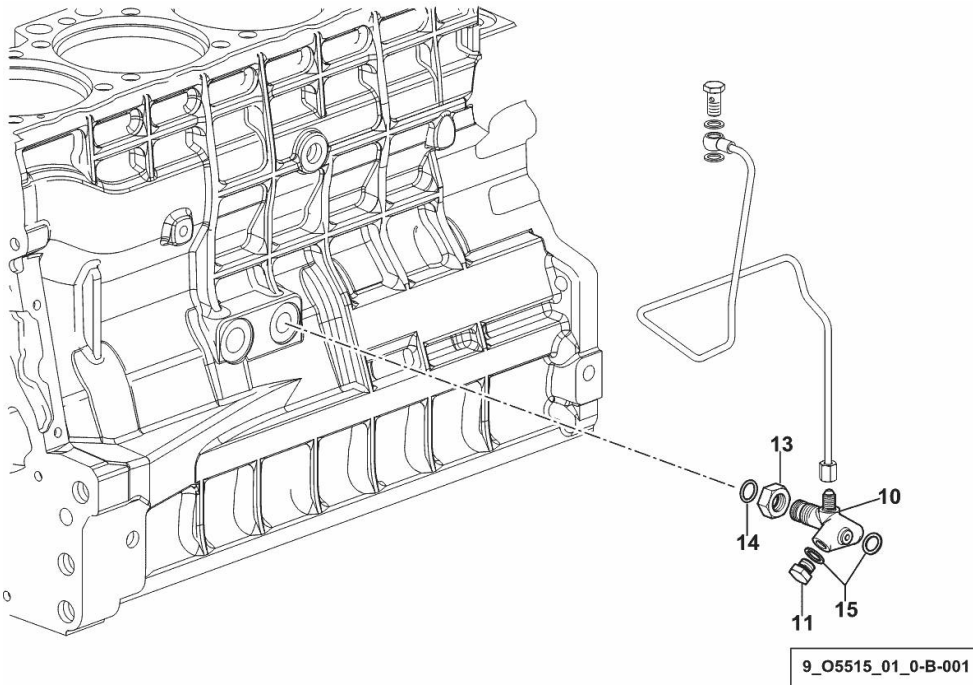

ENGINE OIL AND TURBO PRESSURE SWITCH UNION

Fig.	P/n	QTY	Name
------	-----	-----	------

Notes:

FOR ENGINES PRODUCED IN : RANIPET - INDIA [XV90 -> ZKDP7502W0TH01001]

10	2.3339.787.0/10	1	pipe fitting 7/16"
11	2.3110.403.1	1	plug m 14 p.1.5x12
13	2.1019.129.2/10	1	nut m 18 p.1.5x12
14	2.1533.038.0	1	oil seal 15.45x2.62
15	2.1560.010.0	2	gasket 14.2 x 20

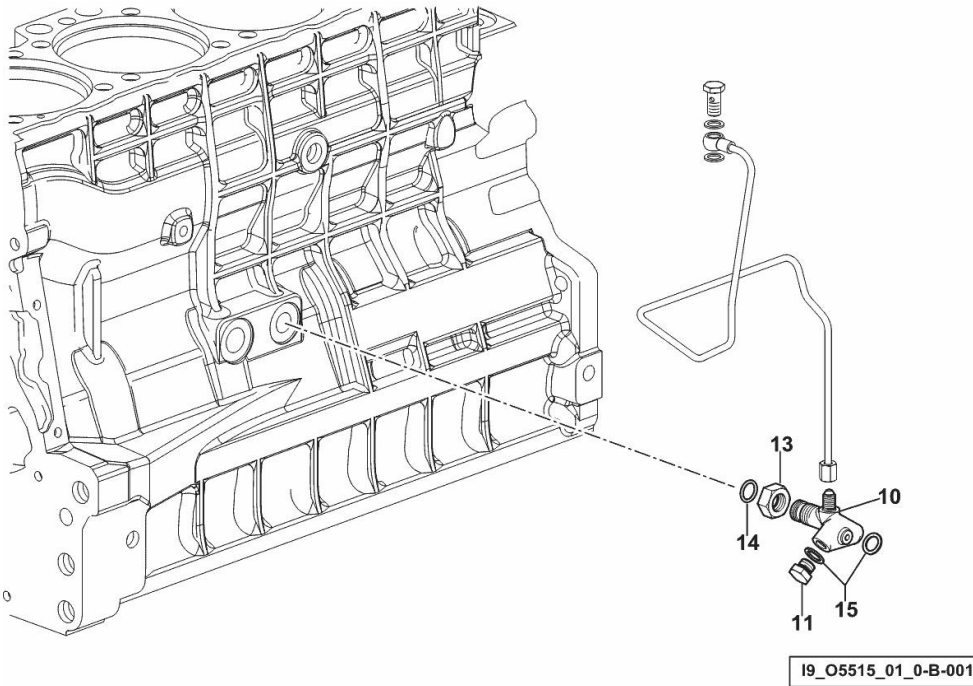

LOWER PLUG FOR CYLINDER BLOCKS

Fig.	P/n	QTY	Name
------	-----	-----	------

Notes:

FOR ENGINES PRODUCED IN : TREVIGLIO ITALY [XV90 -> ZKDP7502W0TH01001]

1	2.3130.003.1	2	plug 3/8" gas
---	--------------	---	---------------

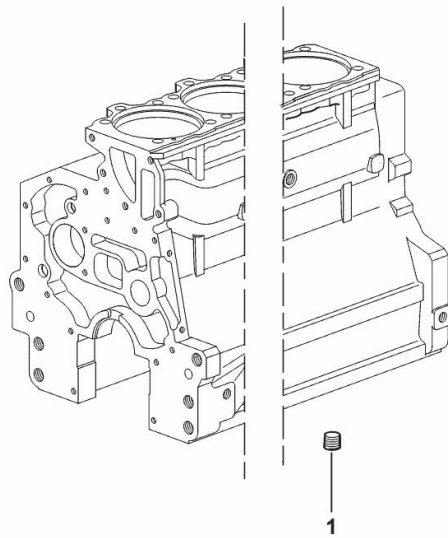

9_33311_06_0-A-001

LOWER PLUG FOR CYLINDER BLOCKS

Fig.	P/n	QTY	Name
------	-----	-----	------

Notes:

FOR ENGINES PRODUCED IN : RANIPET - INDIA [XV90 -> ZKDP7502W0TH01001]

1	2.3130.003.1	2	plug 3/8" gas
---	--------------	---	---------------

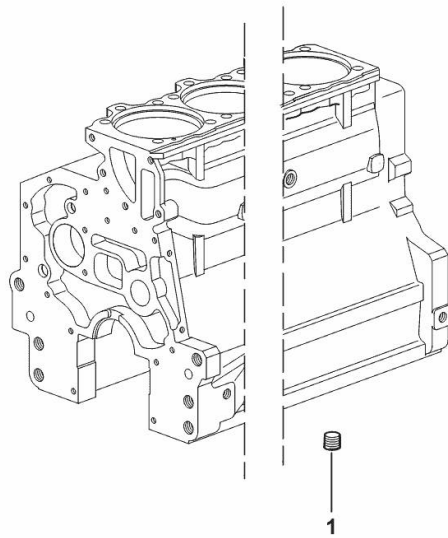

19_37511_06_0-A-001

SIDE PLUG FOR CYLINDER BLOCK

Fig.	P/n	QTY	Name
------	-----	-----	------

Notes:

FOR ENGINES PRODUCED IN : TREVIGLIO ITALY [XV90 -> ZKDP7502W0TH01001]

22	2.1560.017.0	1	gasket 22.2 x 27
23	2.3120.002.4	1	plug m 22 x 1.5

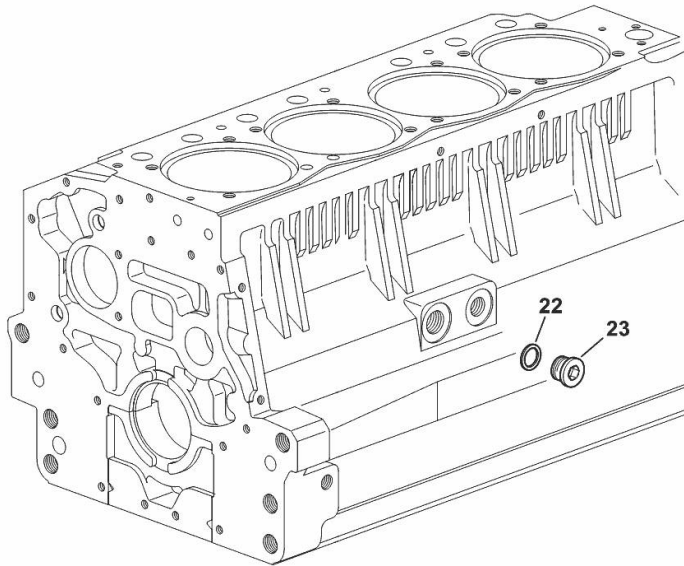

9_33211_07_0-A-001

SIDE PLUG FOR CYLINDER BLOCK

Fig.	P/n	QTY	Name
------	-----	-----	------

Notes:

FOR ENGINES PRODUCED IN : RANIPET - INDIA [XV90 -> ZKDP7502W0TH01001]

22	2.1560.017.0	1	gasket 22.2 x 27
23	2.3120.002.4	1	plug m 22 x 1.5

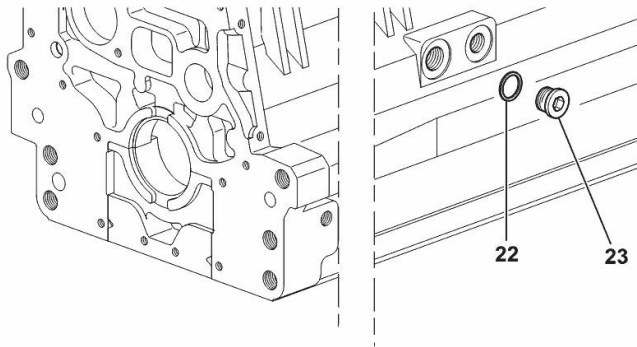

I9_33211_07_0-A-001

CRANKSHAFT

Fig.	P/n	QTY	Name
------	-----	-----	------

Notes:

FOR ENGINES PRODUCED IN : TREVIGLIO ITALY [XV90 -> ZKDP7502W0TH01001]

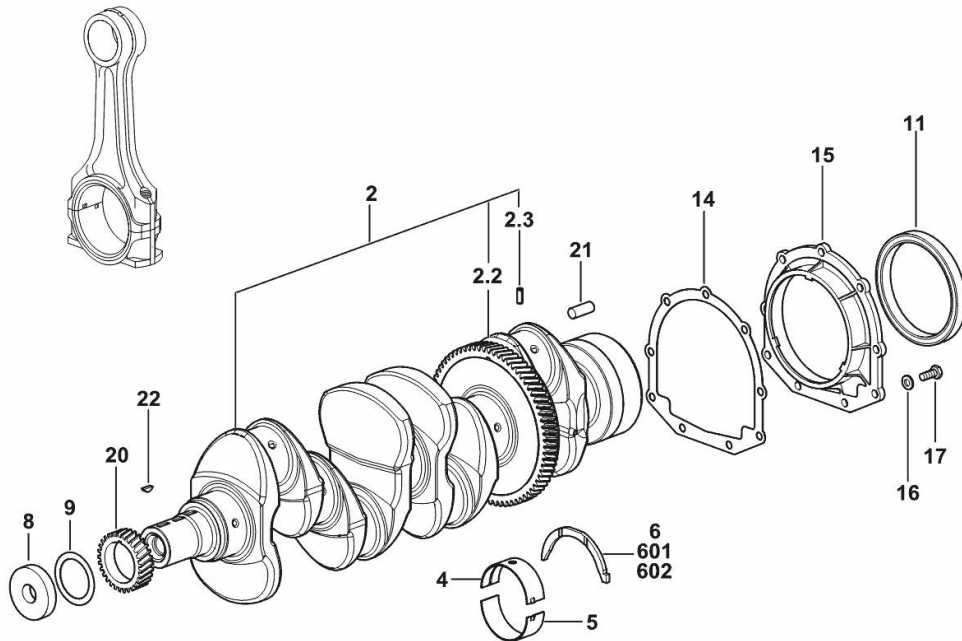

2	0.021.8246.3	1	crankshaft
2.2	0.065.1211.0/10	1	crown wheel
2.3	2.1630.608.0	1	pin 6x16
4	0.019.5455.0	5	main half bushing STANDARD
5	0.019.5456.0	5	main half bushing STANDARD
6	0.065.1218.0	4	shim STANDARD
8	2.1599.524.7	1	washer 21x60x12
9	2.1589.189.0	2	shoulder ring mm 1.00
11	2.1529.073.0	1	special oil seal 110x130x13
14	0.065.1254.0/20	1	gasket
15	0.007.1711.0/10	1	cover
16	2.1475.002.2	9	conical washer 8
17	2.0112.207.2	9	screw m 8 p 1.25 x 20
20	0.065.1323.0/30	1	gear Z = 29
21	2.1651.915.0	1	pin 12x35
22	2.1720.006.0	1	key 4x6.5
601	0.065.1218.7		shim + mm 0.10
602	0.065.1218.8		shim + mm 0.15

9_33212_00_0-A-002

CRANKSHAFT

Fig.	P/n	QTY	Name
------	-----	-----	------

Notes:

FOR ENGINES PRODUCED IN : RANIPET - INDIA [XV90 -> ZKDP7502W0TH01001]

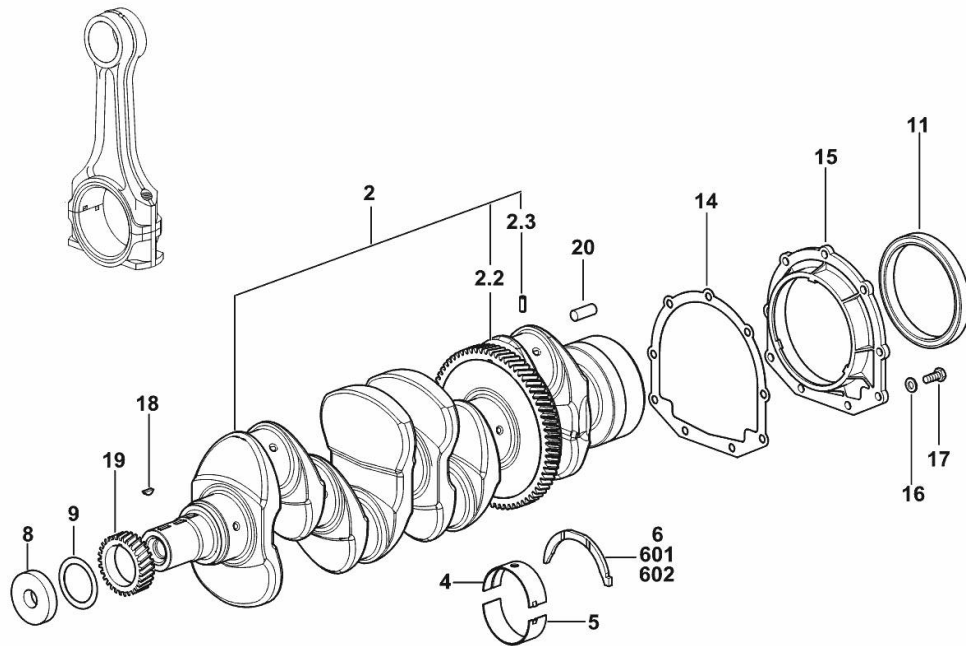

2	0.021.8246.3	1	crankshaft
2.2	0.065.1211.0/10	1	crown wheel
2.3	2.1630.608.0	1	pin 6x16
4	0.019.5455.0	5	main half bushing STANDARD
5	0.019.5456.0	5	main half bushing STANDARD
6	0.065.1218.0	4	shim STANDARD
8	2.1599.524.7	1	washer 21x60x12
9	2.1589.189.0	2	shoulder ring mm 1.00
11	2.1529.073.0	1	special oil seal 110x130x13
14	0.065.1254.0/20	1	gasket
15	0.007.1711.0/10	1	cover
16	2.1475.002.2	9	conical washer 8
17	2.0112.207.2	9	screw m 8 p 1.25 x 20
18	2.1720.006.0	1	key 4x6.5
19	0.065.1323.0/30	1	gear Z = 29
20	2.1651.915.0	1	pin 12x35
601	0.065.1218.7		shim + mm 0.10
602	0.065.1218.8		shim + mm 0.15

19_Q8012_00_0-A-002



Suggest:

For more complete manuals. Please go to the home page.

<https://www.ebooklibonline.com>

If the above button click is invalid. Please download this document first, and then click the above link to download the complete manual.

Thank you so much for reading

ENGINE CRANKSHAFT PULLEY WITH RING-FEEDER RINGS

Fig.	P/n	QTY	Name
------	-----	-----	------

Notes:

FOR ENGINES PRODUCED IN : TREVIGLIO ITALY [XV90 -> ZKDP7502W0TH01001]

1	0.015.6055.0	1	pulley
2	0.011.3515.0/20	1	hub Z = 48
3	0.065.1256.0	2	ring 45x52
4	2.1579.865.0	1	spacer 45.2x51.8x10
5	2.0439.195.7	1	stud bolt m 20 p.1.5x80
6	2.1019.094.7	1	nut m 20 p.1.5
7	2.0112.320.2	6	screw m 10 p.1.5 x 55
8	2.1470.006.2	6	lock washer 10

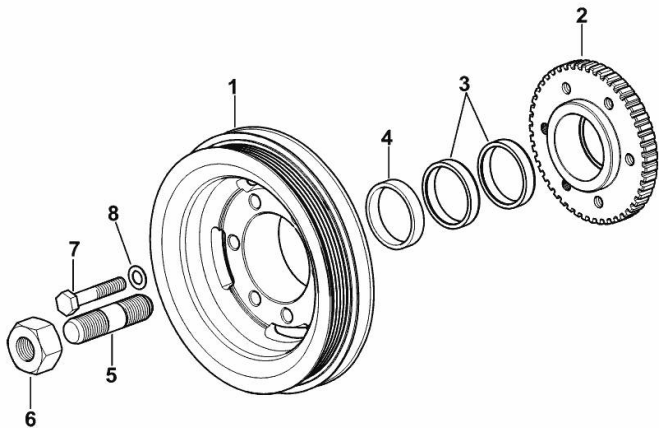

9_O6312_03_0-A-001

ENGINE CRANKSHAFT PULLEY WITH RING-FEEDER RINGS

Fig.	P/n	QTY	Name
------	-----	-----	------

Notes:

FOR ENGINES PRODUCED IN : RANIPET - INDIA [XV90 -> ZKDP7502W0TH01001]

1	0.015.6055.0	1	pulley
2	0.011.3515.0/20	1	hub Z = 48
3	0.065.1256.0	2	ring 45x52
4	2.1579.865.0	1	spacer 45.2x51.8x10
5	2.0439.195.7	1	stud bolt m 20 p.1.5x80
6	2.1019.094.7	1	nut m 20 p.1.5
7	2.0112.320.2	6	screw m 10 p.1.5 x 55
8	2.1470.006.2	6	lock washer 10

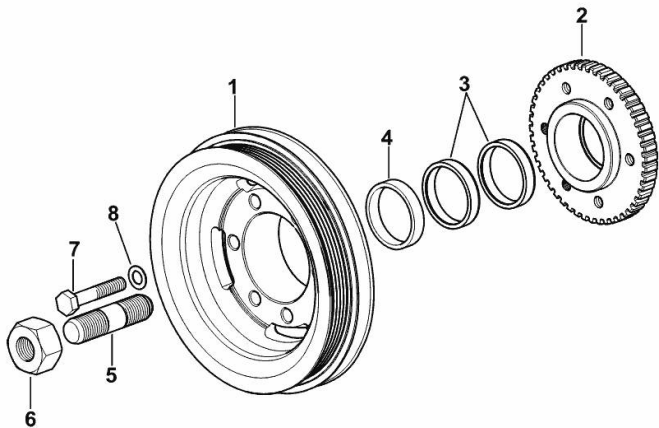

I9_O6312_03_0-A-001

<https://www.ebooklibonline.com>

Hello dear friend!

Thank you very much for reading.

Enter the link into your browser.

The full manual is available for immediate download.

<https://www.ebooklibonline.com>