

Section: ENGINE
CRANKCASE

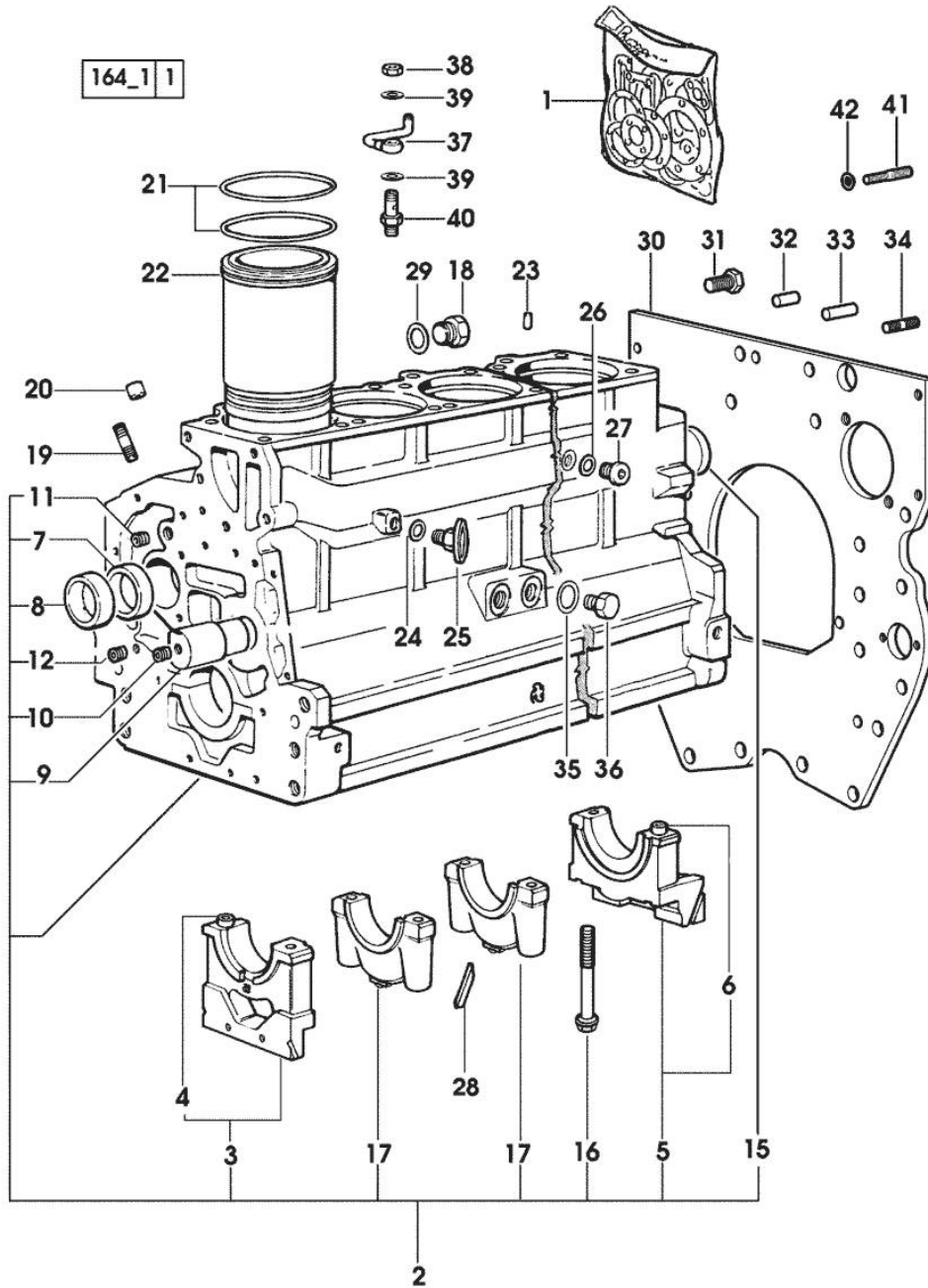

Fig.	P/n	QTY	Name
Notes: [XT-911]			
1	0.337.0050.6		gasket set - FOR ENGINE MOUNTING
2	0.007.1102.6/20	1	crankcase * (...) <- - N.24 - 012.2673.0
3	0.065.1112.7	1	support
4	2.1699.165.0	1	bush 12.3x15x16
5	0.007.0848.3/10	1	support
6	2.1699.165.0	1	bush 12.3x15x16
7	0.065.1141.0	1	special bushing 59X55X30
8	0.065.1140.0	6	special bushing 59X55X20
9	0.066.1151.0	1	pin
10	2.3130.001.1	14	plug 1/8" gas
11	2.3130.002.1	2	plug 1/4" gas
12	2.3130.003.1	8	plug 3/8" gas
15	2.3179.012.0	1	plug 60
16	0.065.1117.0	14	screw m 12 x 100
17	0.065.1114.0/10	5	support
18	2.3199.405.2	1	plug m 28 p.1.5
19	2.0432.003.7	18	stud bolt m 8 p.1.25 / p.1 x 20
20	2.1559.188.2	6	bush 11.4 x 14 x16
21	2.1539.193.0	12	special oil seal 107.62x2.62
22	0.011.0183.0/20	6	engine cylinder 7096 <= X XT-911 6931 <= X XT-913 => 7097 X XT-911 => 6932 X XT-913
22	0.A12.2675.0	6	engine cylinder "A" => 7097 X XT-911 => 6932 X XT-913
22	0.B12.2675.0	6	engine cylinder "B" => 7097 X XT-911 => 6932 X XT-913
23	2.1549.154.2	6	bush 4.8x5.8x16
24	2.1560.010.0	1	gasket 14.2 x 20
25	0.049.1152.0	1	cock
26	2.1560.014.0	1	washer 18.2 x 24
27	2.3120.101.0	1	plug m 18 p.1.5
28	0.066.1152.0/10	4	gasket
29	2.1539.047.0	1	special oil seal 26.7x1.78
30	0.007.0805.0/40	1	flange
31	2.0112.511.2	8	screw m 14 p.2 x 30
32	2.1651.912.0	2	cylindrical plug 12x28

Section: ENGINE
CRANKCASE

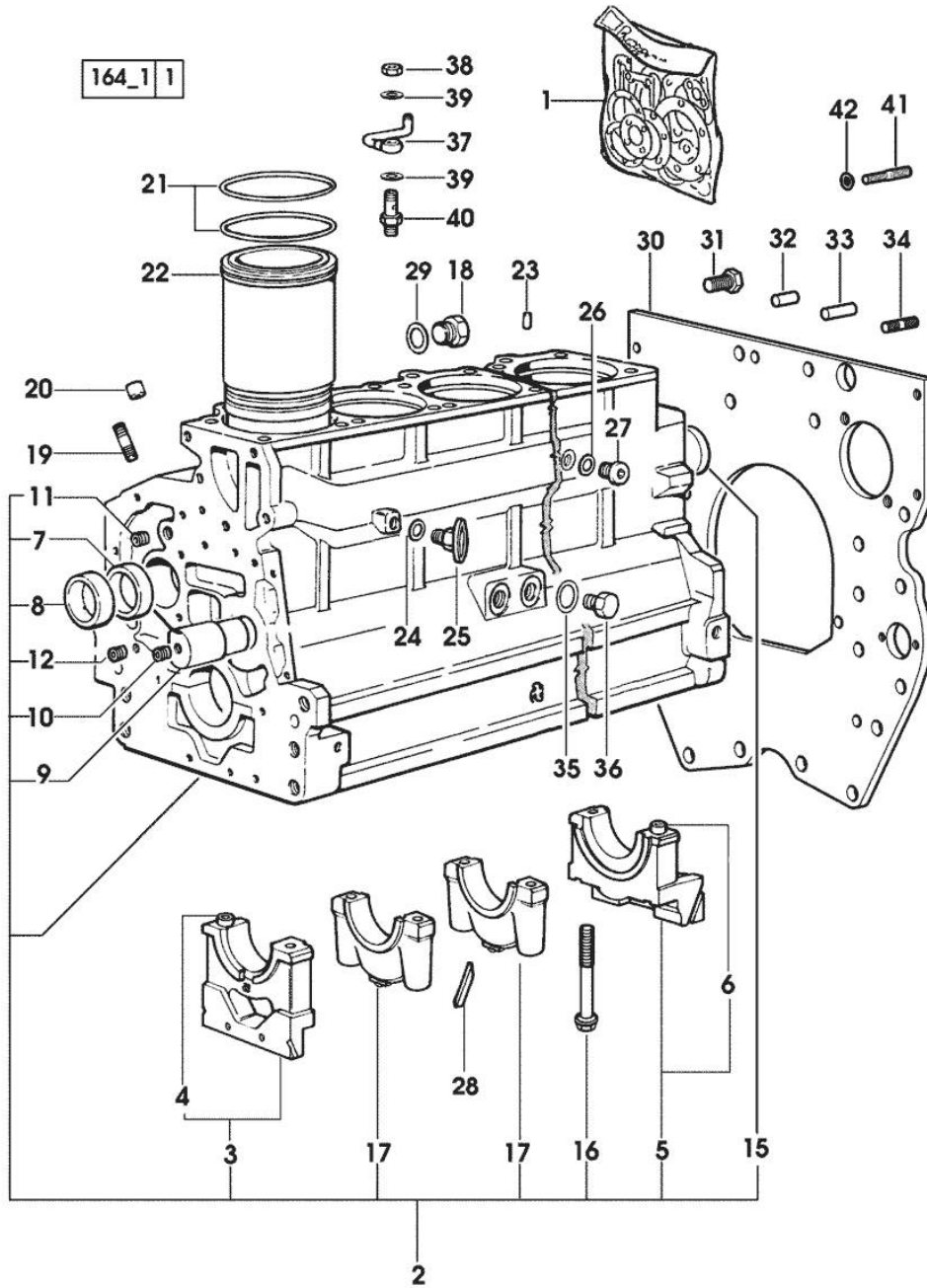
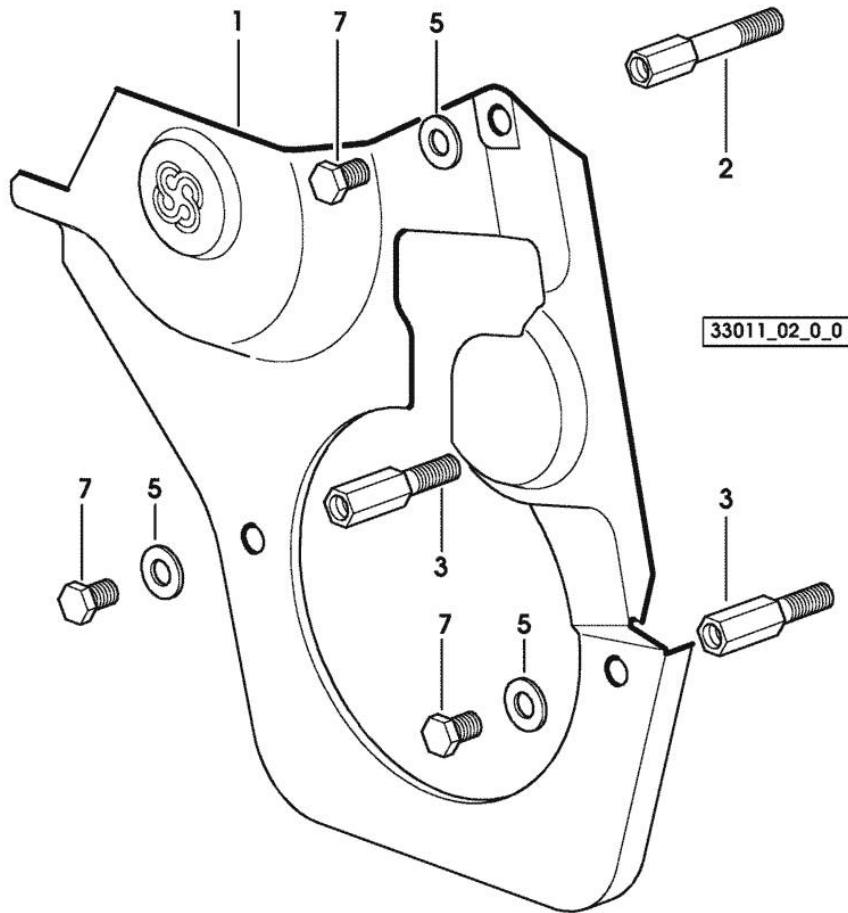

Fig.	P/n	QTY	Name
33	2.1651.917.0	1	cylindrical plug 12x40
34	2.0432.257.7	1	stud bolt m 12 p.1.75 - 1.25 x 30
35	2.1560.017.0	1	gasket 22.2 x 27
36	2.3120.002.4	1	plug m 22 x 1.5
37	0.086.1550.2	6	sprayer nozzle
38	2.1099.108.2	6	special nut m 10 p.1
39	2.1560.006.0	12	gasket 10.2 x 16
40	0.065.1160.3/20	6	valve
41	2.0439.250.7	1	stud bolt m 12 / m 10 x 30
42	0.011.9294.0/10	1	bush

Fig.	P/n	QTY	Name
------	-----	-----	------

Notes:
 [XT-911]

1	0.007.1262.3/50	1	guard
2	0.007.1271.0/10	1	small column m 8 p.1.25 / L = mm 60
3	0.007.1272.0/10	2	small column m 8 p.1.25 / L = mm 50
5	2.1310.004.2	3	flat washer 8.4x17
7	2.0112.205.2	3	screw m 8 p.1.25 x 16



<https://www.ebooklibonline.com>

Hello dear friend!

Thank you very much for reading.

Enter the link into your browser.

The full manual is available for immediate download.

<https://www.ebooklibonline.com>

Section: ENGINE
TIMING CASE

Fig.	P/n	QTY	Name
------	-----	-----	------

Notes:
[XT-911]

10	0.065.1132.0/60	1	guard
11	0.065.1150.0/30	1	gasket
12	2.0432.003.7	2	stud bolt m 8 p.1.25 / p.1 x 20
13	2.0312.219.2	4	screw m 8 p.1.25x65
14	2.1480.014.1	15	washer 8
15	2.1470.004.2	4	lock washer 8
16	2.1011.405.2	2	nut m 8 p.1
17	2.1529.141.0	1	special oil seal
18	2.0312.214.2	3	screw m 8 p.1.25 x 40
19	2.0312.208.2	8	screw m 8 p.1.25 x 25

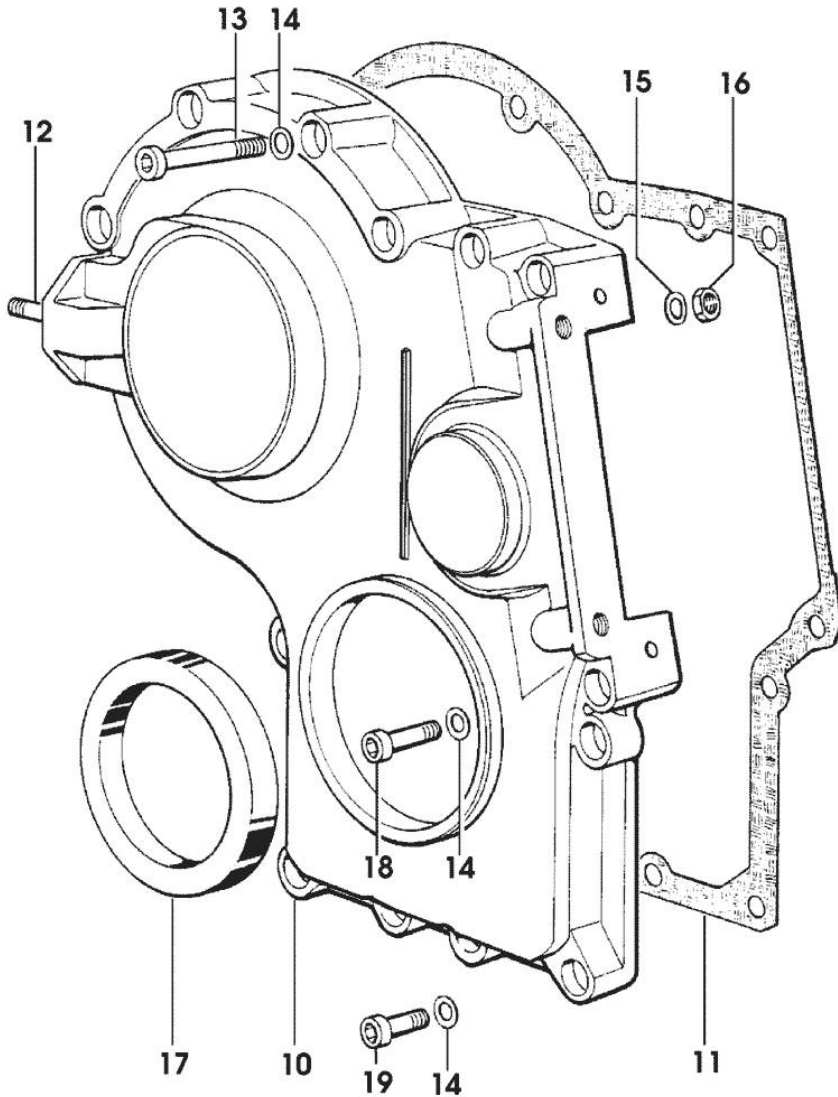

9_33611_01_0_0

Section: ENGINE
CASING COVER

Fig.	P/n	QTY	Name
------	-----	-----	------

Notes:
[XT-911]

30	0.065.1152.0	1	gasket
31	0.065.1151.0	1	cover
32	2.0112.205.2	2	screw m 8 p.1.25 x 16
33	2.0432.005.7	2	stud bolt m 8 p.1.5 / p.1 x 25

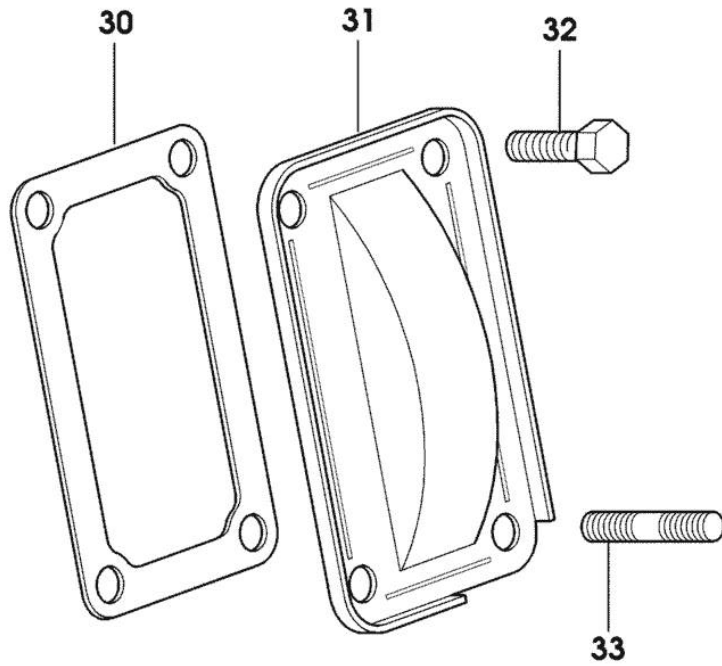

9_33011_04_0_0

Section: ENGINE

CRANKSHAFT

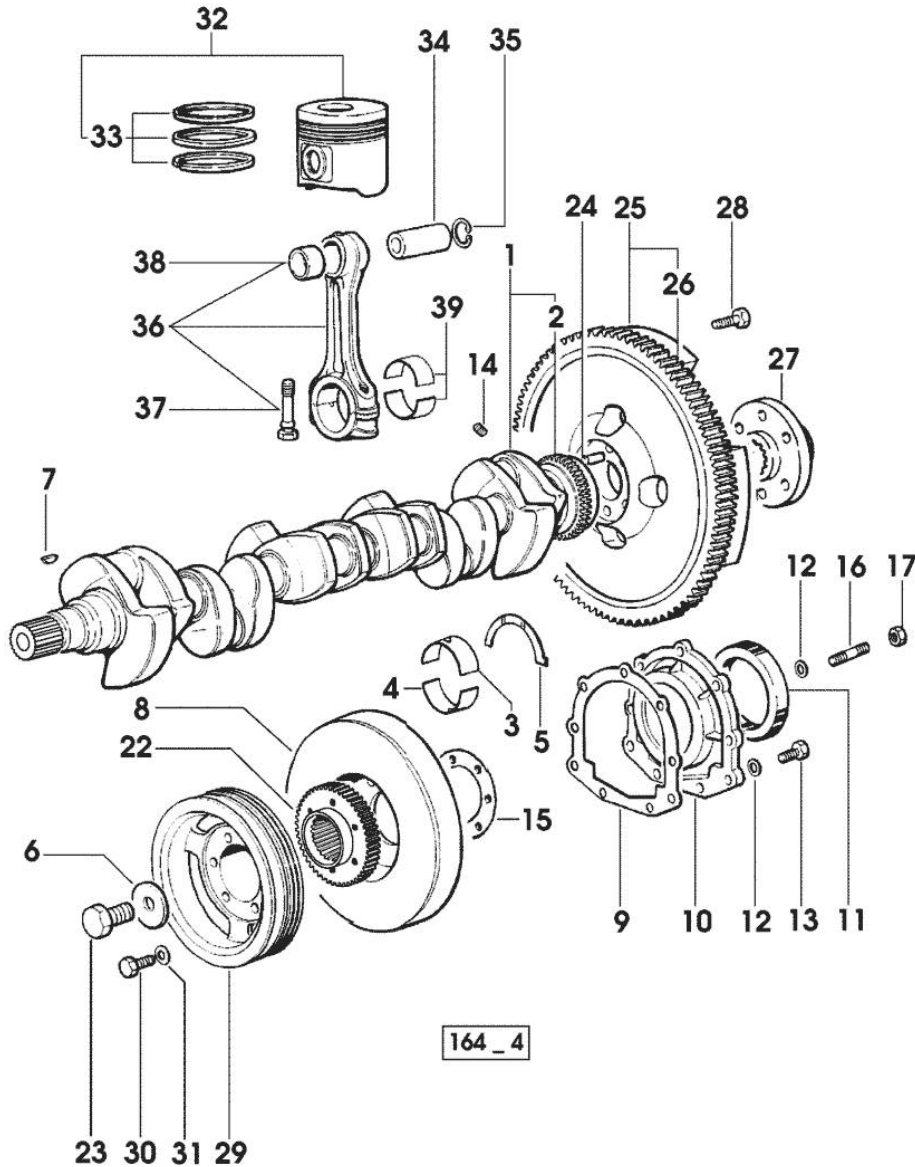

Fig.	P/n	QTY	Name
------	-----	-----	------

Notes:
[XT-911]

1	0.010.4320.3/20	1	crankshaft
2	0.007.0855.0	1	gear
3	0.065.1215.0	7	main half bushing STANDARD
3	0.065.1215.7		main half bushing - mm 0.25
3	0.065.1215.8		main half bushing - mm 0.50
4	0.065.1216.0	7	main half bushing
4	0.065.1216.7		main half bushing - mm 0.25
4	0.065.1216.8		main half bushing - mm 0.50
5	0.065.1218.0	4	shim STANDARD
5	0.065.1218.7		shim + mm 0.10
5	0.065.1218.8		shim + mm 0.15
6	2.1599.524.7	1	washer 21x60x12
7	2.1720.006.0	1	key 4x6.5
8	0.007.1010.3	1	antivibration pulley
9	0.065.1254.0/20	1	gasket
10	0.007.0851.0/10	1	cover
11	2.1529.073.0	1	special oil seal 110x130x13
12	2.1475.002.2	9	conical washer 8
13	2.0112.207.2	7	screw m 8 p 1.25 x 20
14	2.3130.001.1	6	plug 1/8" gas
15	2.1589.137.0	2	shoulder ring 71x110x1
16	2.0432.003.7	2	stud bolt m 8 p.1.25 / p.1 x 20
17	2.1011.105.2	2	nut m 8 p.1.25
22	0.011.2206.0/10	1	hub
23	2.0399.144.7/10	1	screw m 20 p.1.5x51
24	2.1651.915.0	1	pin 12x35
25	0.007.1702.3/30	1	flywheel
26	0.065.1242.0	1	crown wheel Z = 123
27	0.288.3625.0	1	flange
28	2.0139.022.2	6	screw m 12 p.1.25x55
29	0.007.0962.0/20	1	pulley
30	2.0112.322.2	6	screw m 10 p.1.5x65
31	2.1470.006.2	6	lock washer 10
32	0.087.0060.6/30	6	complete piston
32	0.087.0060.A	6	complete piston STANDARD
32	0.087.0060.B	6	complete piston => 6932 X XT-913
32	0.379.0060.6	6	complete piston => 6932 X XT-913 7096 <= X XT-911

Section: ENGINE
CRANKSHAFT

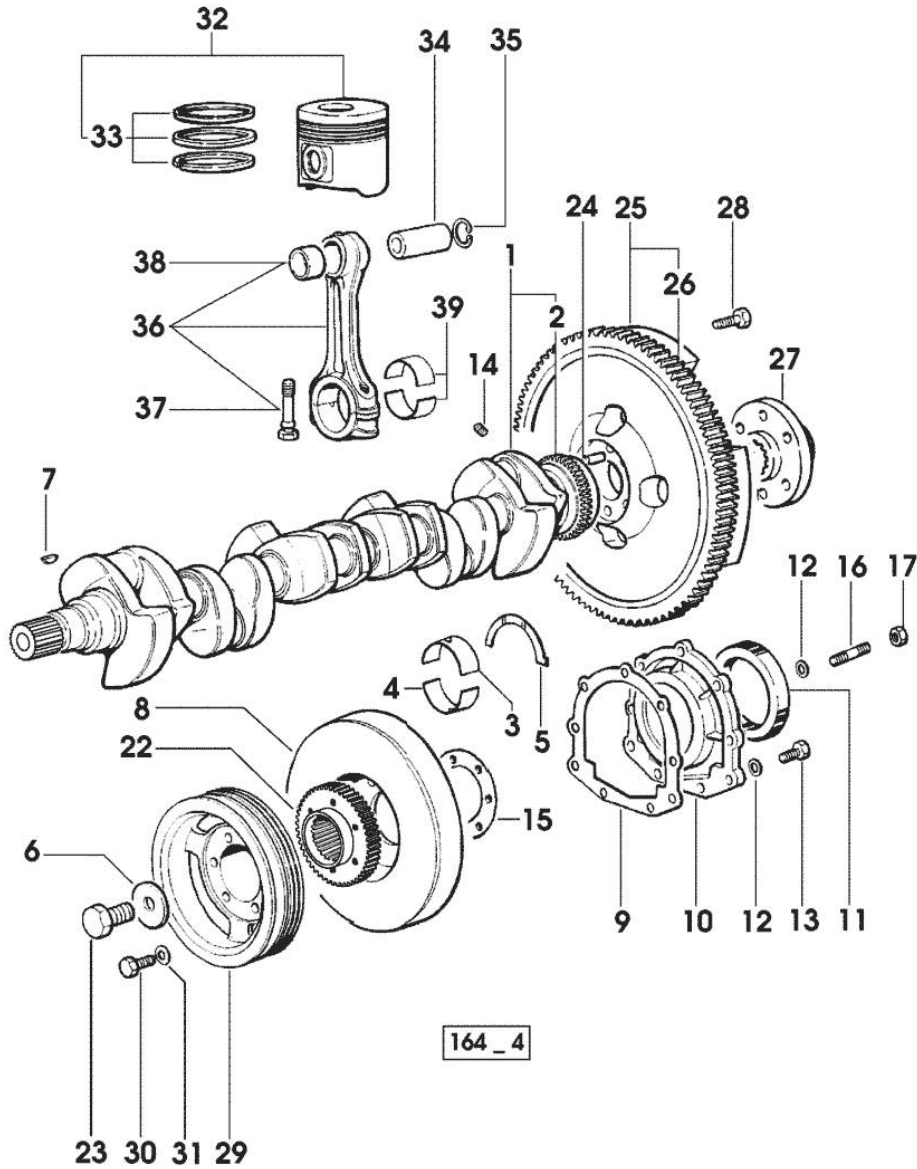

Fig.	P/n	QTY	Name
32	0.379.0060.A	6	complete piston "A" => 7097 X XT-911
32	0.379.0060.B	6	complete piston "B" => 7097 X XT-911
32	0.382.0060.6	6	complete piston 6931 <= X XT-913 - EXPORT U.S.A.
33	0.081.0090.6/10	6	piston ring set - X 110HP
33	0.086.0052.6/10	6	piston ring set - X 130HP
34	0.078.1236.0	6	piston pin Ø 18 / Ø 35 / L = mm 86
35	2.1411.014.1	12	circlip 35
36	0.078.1220.3/30	6	engine connecting rod
37	2.0399.213.0	2	screw m 12 p.1.25x61.5
38	2.1559.114.0/10	1	special bushing
39	0.065.1225.0	12	con.rod half bushing STANDARD - A = 28.75 -> 29.00
39	0.065.1225.7		con.rod half bushing - mm 0.25
39	0.065.1225.8		con.rod half bushing - mm 0.50

Section: ENGINE

CAMSHAFT

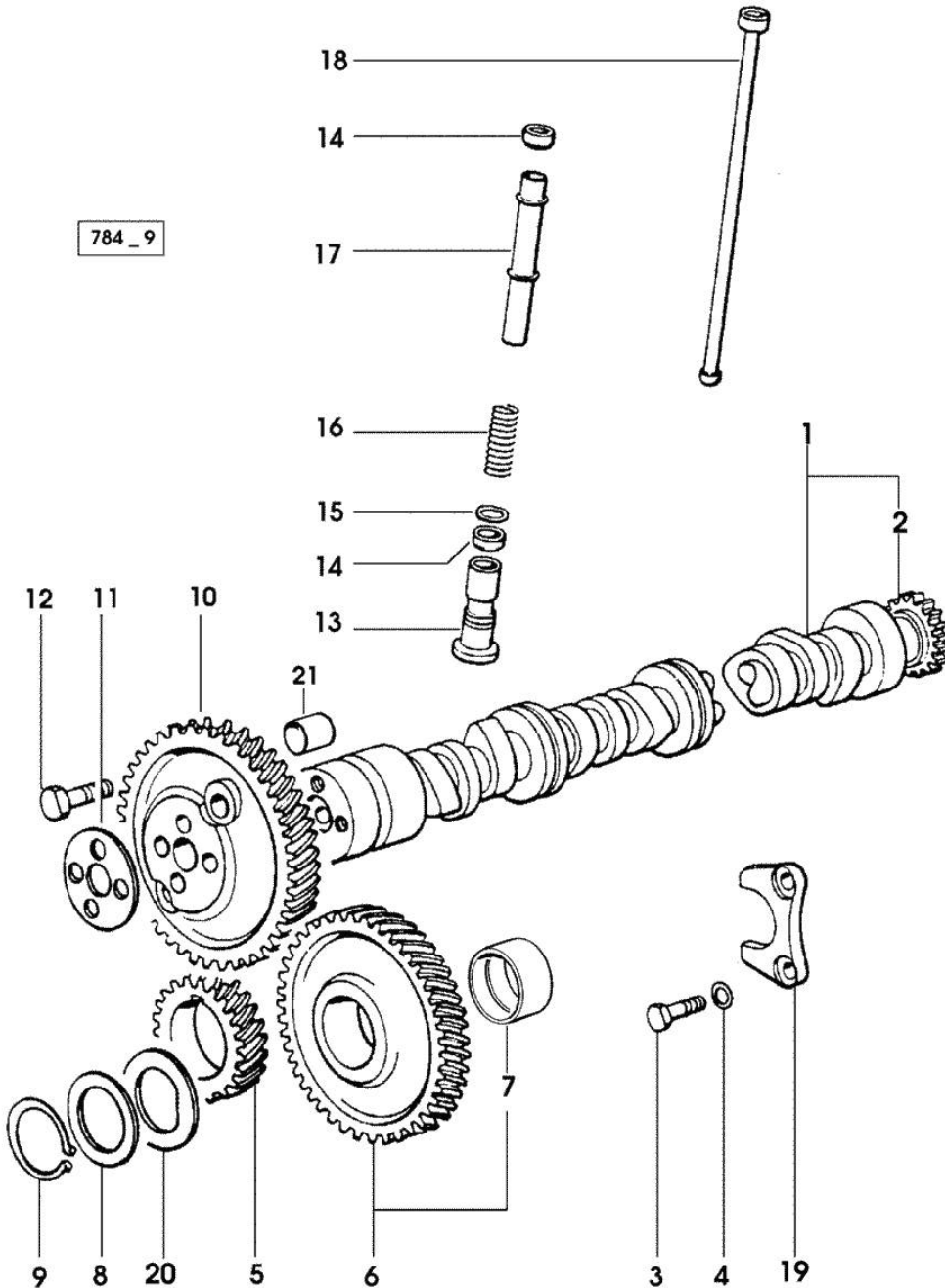

Fig.	P/n	QTY	Name
------	-----	-----	------

Notes:
[XT-911]

1	0.010.4968.3/10	1	camshaft - X 130HP EXPORT U.S.A.
1	0.075.1310.3/30	1	camshaft - X 130HP
2	0.065.1324.0/10	1	gear Z = 32
3	2.0312.205.2	2	screw
4	2.1480.014.1	2	washer 8
5	0.007.1188.0/20	1	gear Z = 29
6	0.007.1177.3/10	1	gear z = 57 - WITH RED IDENTIFICATION STAMP
6	0.007.1178.3/10	1	gear z = 57 - WITH YELLOW IDENTIFICATION STAMP
6	0.007.1179.3/10	1	gear z = 57 - WITH GREEN IDENTIFICATION STAMP
7	2.1559.185.0/10	1	bushing
8	0.065.1352.0	1	shim
9	2.1410.016.1	1	circlip 40
10	0.065.1354.0/20	1	gear z=58
11	0.065.1350.0	1	small disc
12	2.0132.207.2	4	screw m 10 p.1 x 25
13	0.065.1330.0	12	tappets
14	2.1569.114.0/10	24	gasket 14x18.5x8
15	2.1599.437.0	12	shoulder ring
16	2.4019.300.1/10	12	spring 18.5x52x2
17	0.065.1332.0	12	sleeve
18	0.065.1331.2	12	rod
19	0.065.1353.0	1	small plate
20	0.065.1351.0	2	shoulder ring
21	2.1559.398.0	1	bushing 10.5x13x12

Section: ENGINE
CYLINDER HEAD

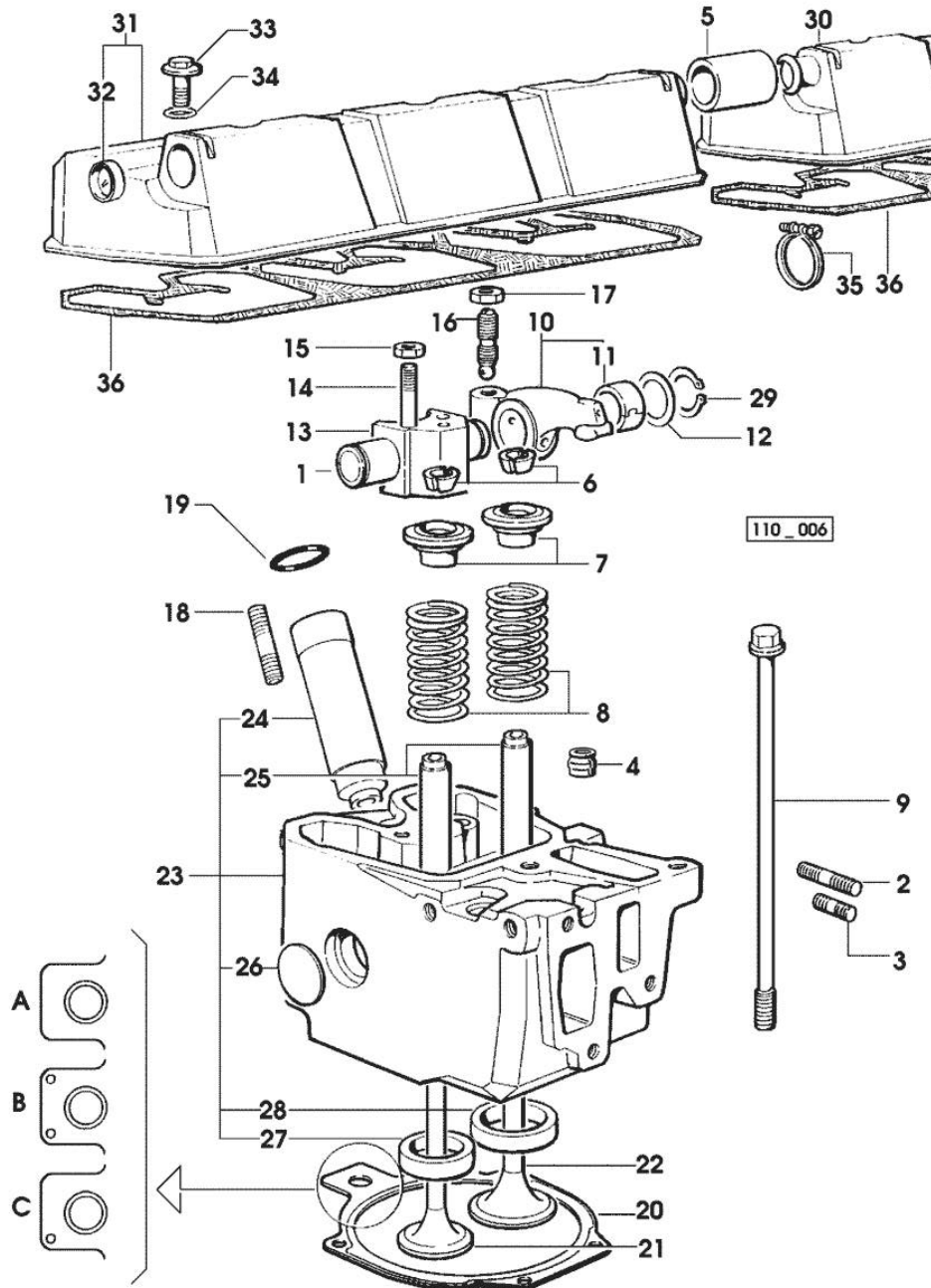

Fig.	P/n	QTY	Name
------	-----	-----	------

Notes:
[XT-911]

1	0.066.1431.0	6	pin
2	2.0432.011.7	6	stud bolt m 8 p.1.25 / p.1 x 40
3	2.0432.005.7	6	stud bolt m 8 p.1.5 / p.1 x 25
4	2.1519.117.0	12	special oil seal
5	0.075.1452.0/10	1	sleeve
6	0.074.1423.0	24	conical valve cotter
7	0.066.1425.0	12	cup
8	2.4019.287.0	12	spring
9	0.012.2673.0	24	screw m 14 p.2x141
9	0.066.1443.0/10	24	-> (...) (...) <-
10	0.066.1432.3	12	rocker arm
11	2.1559.021.0/40	6	bushing 15x19x22
12	2.1599.432.0	2	shoulder ring
13	0.066.1430.0/10	6	support
14	2.0432.163.7	6	stud bolt m 10 p.1.5 / p.1.25 x 45
15	2.1011.421.2	12	nut m 10 p.1.25
16	0.021.1434.0	12	screw
17	2.1011.405.2	2	nut m 8 p.1
18	2.0432.161.7	6	stud bolt m 10 p.1.5 / p.1.25 x 40
19	2.1530.051.0	6	oil seal 20.22x3.53
20	0.078.1451.0/40	4	head gasket -A-
20	0.078.1452.0/30	6	head gasket -B-
20	0.078.1453.0/40	1	head gasket -C-
21	0.010.6022.0	6	exhaust valve mm 39.1 / Ø mm 9
21	0.066.1421.0	6	exhaust valve
22	0.010.6016.0	6	inlet valve mm 43.63 / Ø mm 9
22	0.010.6017.0	6	inlet valve mm 43.63 / Ø mm 9
23	0.007.1360.3/60	6	head
23	0.012.2693.3/10	6	engine head
24	0.010.6041.0	1	bush
25	0.007.1779.0/10	2	valve guide
26	2.3170.012.1	2	expansion plug 30
27	0.078.1426.0	1	valve seat

Section: ENGINE
CYLINDER HEAD

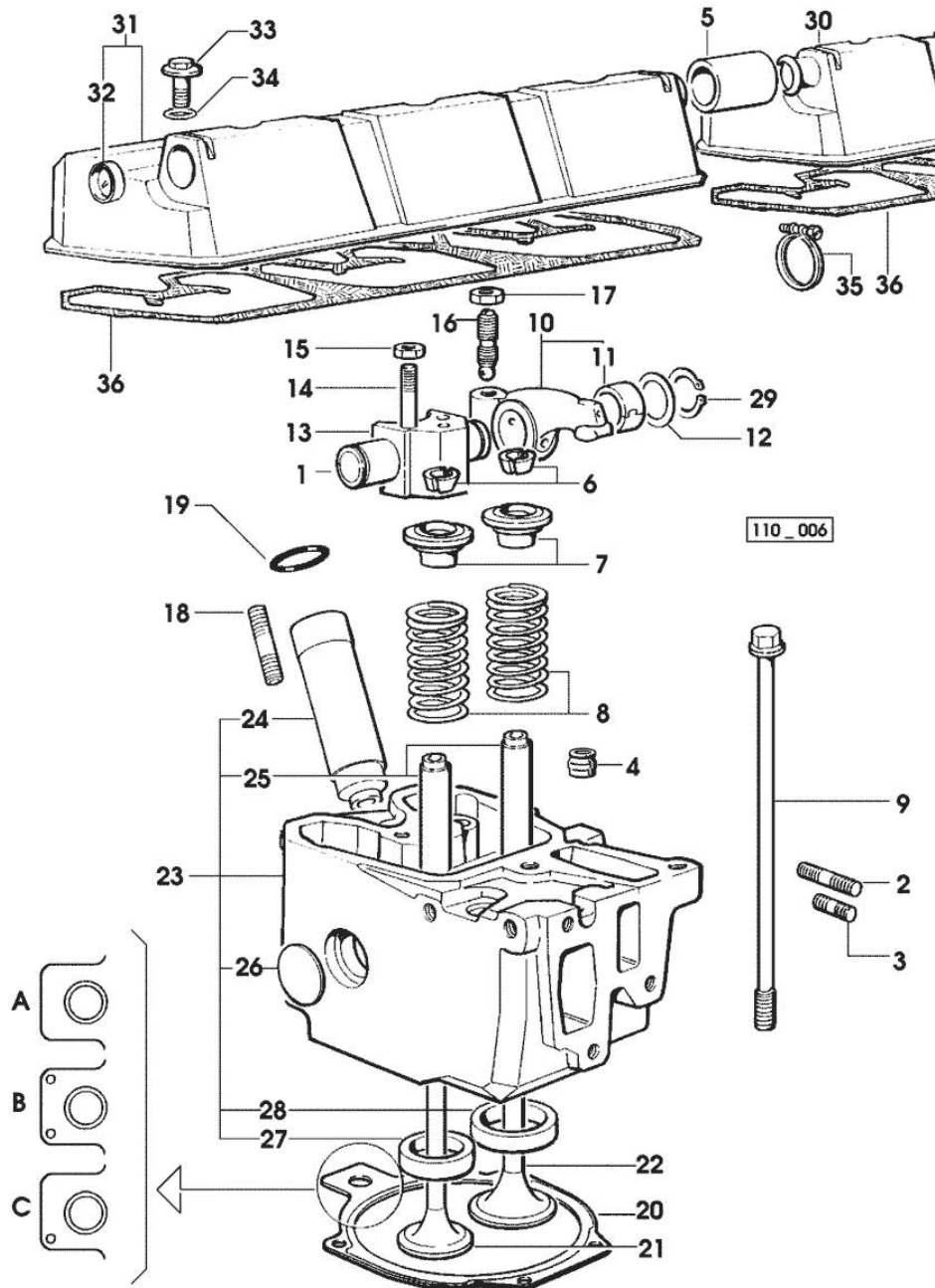

Fig.	P/n	QTY	Name
28	0.066.1427.0	1	valve seat
29	2.1410.055.7	2	circlip 19
30	0.078.1450.3	1	cover
31	0.078.1440.3	1	cover
32	2.3171.008.4	1	plug 20
33	2.0399.130.2/10	6	screw m 8x36x44
34	2.1532.035.0	6	oil seal 14x1.78
35	2.6859.052.2	2	clamp
36	0.009.3877.0/10	2	tappet gasket

Section: ENGINE
LUBRICATION

Fig.	P/n	QTY	Name
------	-----	-----	------

Notes:
[XT-911]

1	2.0312.205.2	2	screw
2	2.1480.014.1	2	washer 8
3	0.041.1135.4	1	plug 1" gas
4	2.1569.072.0	1	gasket 32 x 39.5 x 2
5	0.065.1565.0/10	1	pipe union
6	2.1539.042.0	1	special oil seal 47.35x1.78
7	0.065.1567.0/10	1	filter
8	0.080.1513.2/10	1	dipstick
9	2.1539.065.0	2	special oil seal 8.73 x 1.78
10	2.3199.001.2	2	plug 1/2" gas
11	2.1560.054.0	2	gasket 21 x 26
12	0.007.0849.0/10	1	gasket
13	2.3339.307.0	2	pipe fitting m 22 p.1.5-3/4"
18	2.1470.004.2	34	lock washer 8
20	2.0112.215.2	25	screw m 8 p.1.25 x 40
21	0.007.1311.0/10	1	oil sump
22	2.0112.229.2	3	screw m 8 p.1.25 x 100
23	2.0112.235.2	2	screw m 8 p.1.25 x 130
24	2.0112.241.2	4	screw m 8 p.1.25 x 160
25	2.0112.243.2	2	screw m 8 p.1.25x170
26	2.1579.854.2	2	spacer 8.5x20x5

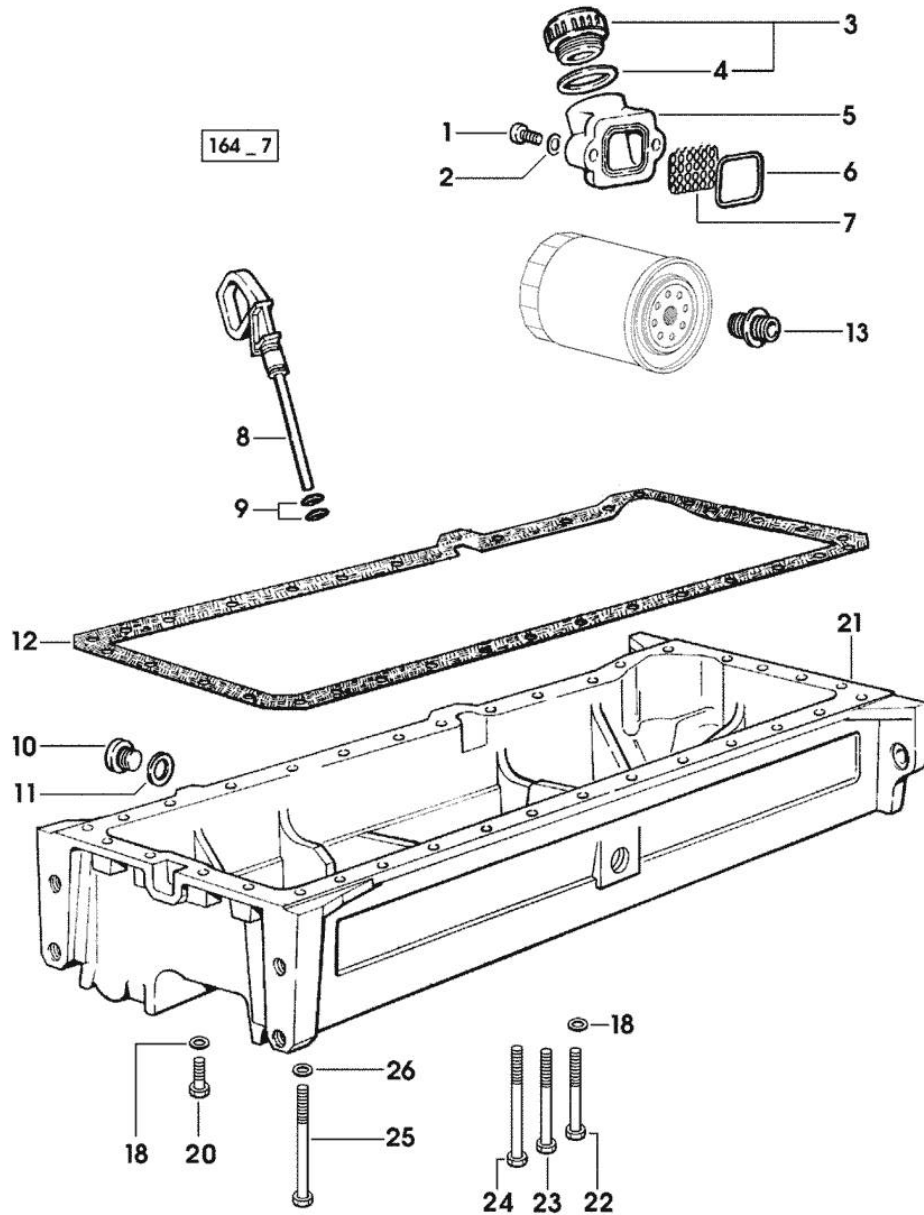

LUBRIC. OIL FILTER

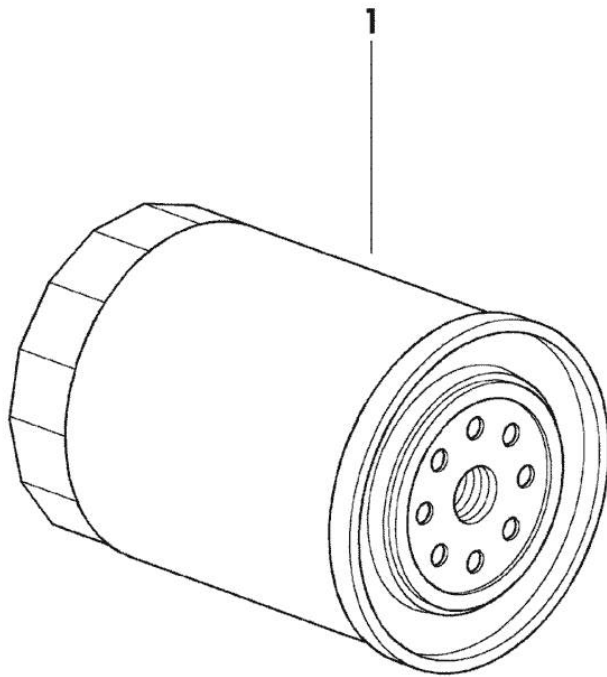

Fig.	P/n	QTY	Name
------	-----	-----	------

Notes:
[XT-911]

1	2.4419.340.0	2	oil filter element
---	--------------	---	--------------------

9_33815_02_0_0

Section: ENGINE
LUBRICATION

Fig.	P/n	QTY	Name
------	-----	-----	------

Notes:
 [XT-911]

1	0.011.0087.4	1	tube
2	2.1539.153.0	1	oil seal 32.99x2.6
3	2.1470.004.2	1	lock washer 8
4	2.0112.205.2	1	screw m 8 p.1.25 x 16
5	0.007.0867.0	1	bush
6	2.1310.006.2	3	flat washer 10.5x21
7	2.0112.322.2	3	screw m 10 p.1.5x65
8	0.007.0972.0	2	shim
9	0.007.0973.0	2	shim
10	0.010.0194.4/30	1	oil pump

☞ 0.010.0194.4/30
 ☞ 01.00.31

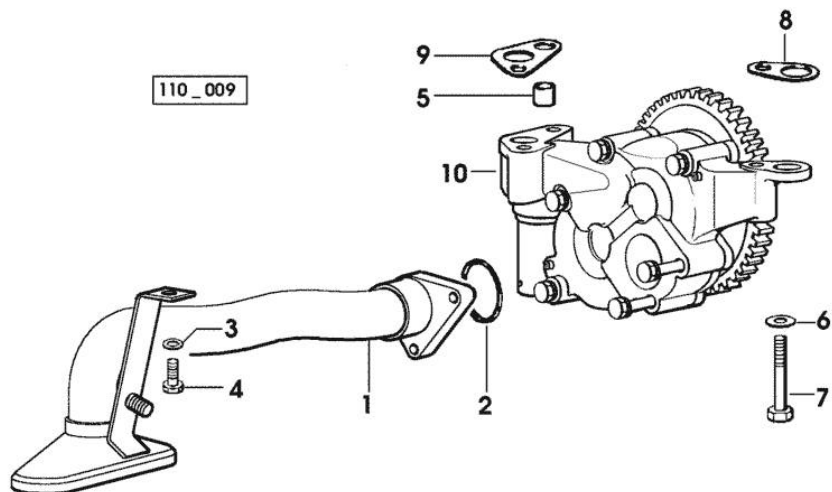



Suggest:

For more complete manuals. Please go to the home page.

<https://www.ebooklibonline.com>

If the above button click is invalid. Please download this document first, and then click the above link to download the complete manual.

Thank you so much for reading

OIL PUMP

Fig.	P/n	QTY	Name
------	-----	-----	------

Notes:
[XT-911]

1	0.010.0194.4/30	1	oil pump ☞ 0.010.0194.4/30
2	0.007.0866.3/10	1	valve
3	0.010.1709.0	1	gear z=8
4	2.0112.220.2	2	screw m 8 p.1.25x55
5	2.1475.002.7	6	washer 8.4
6	2.0112.219.2	2	screw m 8 p.1.25x55
7	0.010.0195.3/20	1	cover
8	2.1410.064.7	1	circlip
9	0.010.1708.0/20	1	gear z=8
10	2.1651.204.0	1	pin 3x10
11	0.000.0000.1		cannot be supplied
12	0.000.0000.1		cannot be supplied
13	2.1560.020.0	1	copper gasket 24.3x32
14	2.0112.217.2	2	screw m 8 p.1.25 x 45
15	2.1630.608.0	2	pin 6x16
16	0.000.0000.1		cannot be supplied

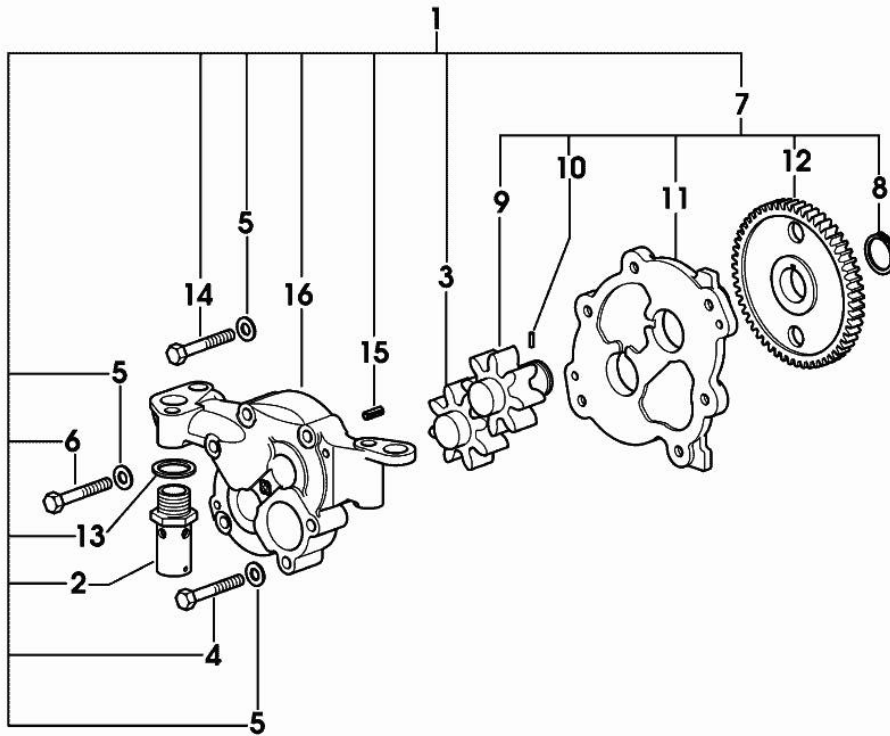

0_010_0194_4_30

Section: ENGINE
LUBRICATION

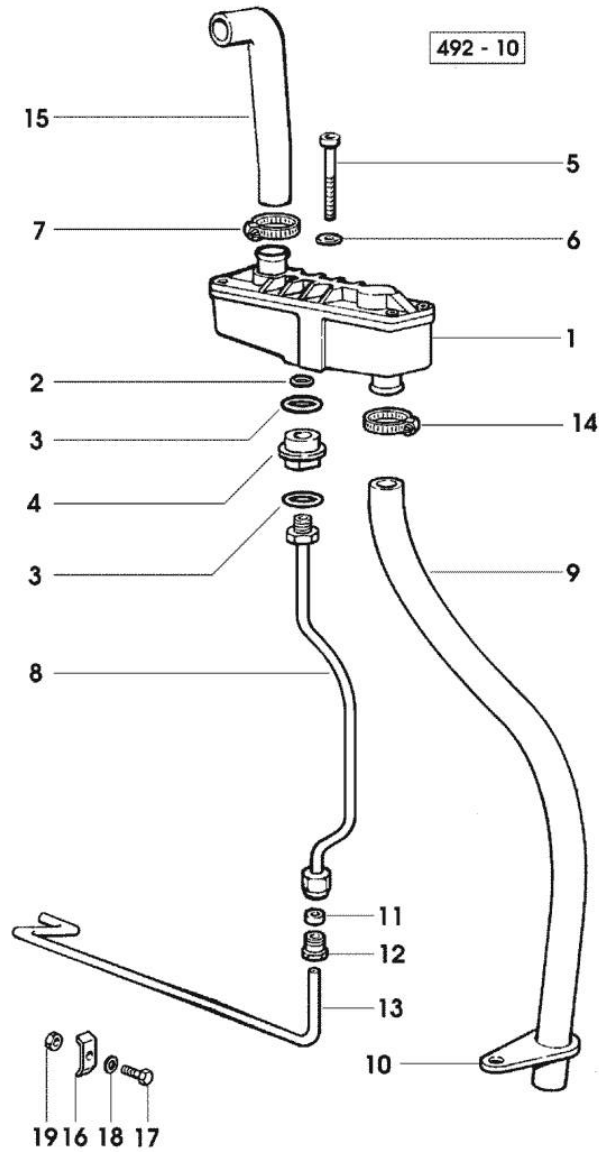

Fig.	P/n	QTY	Name
Notes:			
[XT-911]			
1	0.075.1557.4	1	sediment bowl ☞ 01.00.37
2	2.1560.008.0	1	gasket 12.2 x 18
3	2.1539.072.0	2	special oil seal 23.52 x 1.78
4	0.075.1553.0	1	bush
5	2.0312.221.2	2	screw m 8 p.1.25x75
6	2.1480.014.1	2	washer 8
7	2.6859.086.0	2	clamp
8	0.007.0861.0	1	tube
9	0.075.1554.0	1	tube
10	0.075.1151.0	1	bracket
11	2.3350.003.1	1	nosepiece 8
12	2.3339.418.1	1	pipe fitting m 12 p.1
13	0.007.0970.0	1	tube
14	2.6859.086.0	1	clamp
15	0.075.1453.0/10	1	tube
16	0.002.8816.0	1	small plate
17	2.0112.007.2	1	screw m 6 p.1 x 20
18	2.1310.002.2	1	flat washer 6.4x12.5
19	2.1011.103.2	1	nut m 6 p.1

<https://www.ebooklibonline.com>

Hello dear friend!

Thank you very much for reading.

Enter the link into your browser.

The full manual is available for immediate download.

<https://www.ebooklibonline.com>