

**6650, 6750,
6850 and 6950
Self-Propelled
Forage Harvesters**
(From Serial No. 504200)

**John Deere Werke Zweibrücken
OMZ92777 Issue E9**

North American Version
LITHO IN U.S.A.
ENGLISCH

Contents

	Page		Page
Identification Views	00-1	Automatic kernel processor roll clearance . . .	20-28
Safety		Manual kernel processor roll clearance	20-28
General	05-1	ROW-TRAK control unit	20-29
Service	05-10	Area counter	20-38
Safety Decals	10-1	Lighting System and Signals	
Controls and Instruments		Parking lights/low-beam headlights	25-1
General view	15-1	Full-beam headlights	25-1
Switch console	15-2	Turn signals	25-3
Multi-function lever	15-6	Work lights	25-5
Corner post	15-7	Hazard warning lights	25-5
Roof console	15-9	Indicator light test	25-6
Automatic function control	15-10	Operator's Cab	
Steering column	15-11	Operator's seat	30-1
Switch console — functions	15-12	Lumbar support	30-2
Multi-function lever — functions	15-20	Seat-belt	30-2
Roof switch console — functions	15-23	Left-hand armrest	30-3
Steering column — functions	15-24	Right-hand armrest	30-3
Warning Devices and Monitors		Ashtray	30-3
Indicator lights I	20-1	Air-comfort seat	30-4
Indicator lights II	20-6	Passenger seat	30-5
Fuel gauge	20-9	Storage compartment for Operator's	
Coolant temperature gauge	20-9	Manuals	30-5
Automatic function control lights	20-10	Cooling compartment	30-6
Infotrak monitor	20-11	Steering column	30-6
Input of specific machine data	20-15	Foot brakes	30-7
Software version	20-15	Parking brake	30-7
Cutterhead alarm speed	20-18	Releasing parking brake	30-8
SERVICE information	20-19	Hitch control	30-8
Automatic function control	20-20	Sun visor	30-9
Sharpening cycles	20-21	Inside mirror	30-9
Automatic knife sharpening	20-22	Outside mirror	30-9
Sharpening stone home position (manual)	20-24	Interior lighting	30-9
Automatic stationary knife adjustment	20-24	Adjustable air louvers	30-10
Manual stationary knife adjustment	20-26	Radio and CB radio	30-11
Kernel processor roll clearance	20-27	Pre-Starting Checks	
		Daily checks	35-1
		Engine oil level	35-1
		Hydraulic oil level	35-1

Continued on next page

All information, illustrations and specifications in this manual are based on the latest information available at the time of publication. The right is reserved to make changes at any time without notice.

OMZ92777 E9-19-01MAY99

COPYRIGHT© 1999
DEERE & COMPANY
European Office Mannheim
All rights reserved
A John Deere ILLUSTRATION® Manual

Contents

	Page		Page
Fuel level	35-2	Preparations and Field Operation	
Tires	35-2	Preparations for harvesting grass	65-1
Hydrostatic oil level	35-3	Preparations for harvesting corn	65-1
Fuel system	35-3	Preparations for harvesting whole-plant silage	65-2
Lubricating the forage harvester	35-4	Preparations for harvesting alfalfa	65-2
Checks in operator's cab	35-4	Preparations for harvesting sorghum	65-2
Operating the Engine		Adjusting area counter switch	65-3
Starting the engine	40-1	Changing the harvesting unit	65-4
Engine oil pressure indicator light	40-4	Field operation of forage harvester	65-4
Warming up engine	40-4	Reverser operation	65-9
Engine idle	40-4	Feeding System	
Ether starting aid	40-5	Safety information	70-1
Booster battery	40-9	Electromagnetic clutch	70-2
Stopping the engine	40-10	Cutterhead speed sending unit	70-4
Cold-weather operation	40-10	Length-of-cut transmission	70-4
Driving and Transporting Forage Harvester		Adjusting length of cut	70-5
Wear seat-belt	45-1	Harvesting unit speed	70-5
Driving the forage harvester	45-1	Feed roll slip clutch	70-6
Releasing the parking brake	45-2	Length-of-cut transmission service	70-6
Operating foot brakes	45-2	Feed roll drive	70-8
Engaging a gear	45-2	Replacing wear plates	70-8
Adjusting engine speed	45-3	Upper feed roll guides	70-10
Forward and reverse travel	45-3	Attaching feed roll springs	70-11
Travel speed	45-4	Adjusting feed roll springs	70-12
Hydrostatic system	45-5	Opening feed roll housing	70-12
Four-wheel drive	45-6	Smooth roll scraper	70-13
Transport information	45-6	Closing feed roll housing	70-14
Hitch	45-7	Feed roll housing safety switch	70-15
Transport hooks	45-7	Hydraulic reverser motor	70-15
Wheels and Ballast		Troubleshooting — feeding system	70-17
Tire maintenance	50-1	Metal Detector	
Infotrak monitor setting when changing tires	50-4	Metal detector operation	75-1
Tires on driven wheels	50-4	Activating the metal detector	75-2
Tires on steered wheels	50-5	Operation without metal detector	75-3
Tire pressures	50-6	When ferrous metal is detected	75-4
Rear weights	50-6	Adjusting the locking pawl	75-5
Overall width and track width	50-9	Metal detector test	75-7
Front-wheel track width	50-10	Safety rules	75-9
Wheel rim chart	50-11	Electronic box	75-10
Harvesting Units and Attachments	55-1	Relay box	75-11
Attaching and Detaching Harvesting Units		Indicator light test chart	75-15
Attaching 6-row row-crop unit	60-1	Test charts	75-16
		Troubleshooting	75-18
		Cutterhead, Drives, Guards, Covers	
		Engine access	80-1
		Drive	80-5

Continued on next page

<https://www.ebooklibonline.com>

Hello dear friend!

Thank you very much for reading.

Enter the link into your browser.

The full manual is available for immediate download.

<https://www.ebooklibonline.com>

Contents

	Page		Page
Main clutch	80-6	Roll wear and replacement	85-13
Replacing main drive belt	80-9	Potentiometer, automatic adjustment	85-13
Checking belt alignment	80-11	Replacing lower roll drive belt	85-14
Cutterhead knives	80-12	Troubleshooting	85-15
Replacing partial set of knives	80-14		
Replacing complete set of knives	80-15	Power Chute	
Replacing clamp bar	80-17	Power chute	86-1
Replacing threaded bar	80-18	Service and operation	86-7
Knife screw torque	80-19	Drive belts	86-7
Preparations for knife sharpening	80-20		
Manual knife sharpening	80-20	Discharge	
Automatic knife sharpening device	80-24	Blower and discharge spout	90-1
Replacing sharpening stone	80-26	Blower bottom	90-1
Aligning knife sharpening device	80-28	Replacing wear plate	90-1
Sharpening stone end switch	80-29	Installing wear plate	90-3
Adjusting stationary knife	80-31	Adjusting blower paddles	90-4
Checking stationary knife	80-35	Adjusting deflecting edges	90-5
Removing stationary knife	80-36	Spout worm gear and ring gear	90-8
Installing stationary knife	80-37		
Eliminating end play of adjusting spindle	80-39	Fuel, Lubricants, Coolant and Capacities	
Bottom and outlet bands	80-41	Fuel	95-1
Adjusting bottom band	80-41	Diesel engine oil	95-2
Adjusting outlet band	80-42	Engine coolant	95-4
Recirculating screens	80-44	Transmission oil	95-6
Installing/changing recirculating screen	80-44	Brake fluid	95-11
Adjusting recirculating screen	80-47	Grease	95-11
Installing spiral floor	80-49		
Adjusting spiral floor	80-51	Lubrication, Periodic Service	
Adjusting the service cover	80-54	Lubrication charts	100-2
Transition chute	80-54	Central lubrication system	100-10
Cutterhead service cover	80-55	Break-in service	100-19
Removing cutterhead with harvesting unit	80-56	Service intervals	100-20
Installing cutterhead with harvesting unit	80-60	After the first 100 operating hours	100-21
Main drive troubleshooting	80-61	Every 250 operating hours	100-22
Cutterhead troubleshooting	80-62	Every 500 operating hours	100-22
Knife sharpener troubleshooting	80-63	Every 1000 operating hours	100-23
Stationary knife troubleshooting	80-65	Every 1500 operating hours	100-23
		Every 2000 operating hours	100-23
		As required	100-23
		Every year	100-24
		Every 2 years	100-24
		V-belts	100-24
		Chains	100-25
Kernel Processor		Service — Engine	
Kernel processor quick conversion	85-1	Engine compartment	105-1
Adjusting service cover	85-6	Adjusting engine valve clearance	105-1
Installing/removing kernel processor	85-8		
Breaking-in kernel processor	85-9		
Field operation	85-9		
Kernel processor service	85-9		
Adjusting roll spacing	85-10		
Adjusting stop screws	85-11		
Adjusting clearance indicator	85-11		
Pretension, lower roll drive belt	85-12		
Adjusting scrapers	85-12		

Continued on next page

Contents

	Page		Page
Rocker arm cover and crankcase ventilation	105-2	Dome light	110-56
Checking crankcase oil level	105-4	Switch lighting	110-56
Changing engine oil and filter	105-5	Indicator light bulbs	110-56
Service — fuel system	105-10		
Fuel filler neck	105-11	Service — Hydraulic System	
Fuel tank water trap	105-11	Pressure relief valve	115-1
Fuel system, John Deere engine	105-12	System operation	115-2
Fuel system, John Deere engine	105-13	Accumulators	115-3
Fuel system, Cummins engine	105-14	Pressure control switch	115-4
Fuel shut-off valve	105-15	Hydraulic components — neutral oil flow . . .	115-5
Water trap, John Deere engine	105-15	Draining hydraulic oil	115-8
Fuel filter, John Deere engine	105-16	Replacing hydraulic oil filter	115-8
Checking fuel injection nozzles	105-17	Refilling hydraulic oil	115-9
Bleeding the fuel system	105-17	Temperature and pressure sending units . . .	115-9
Fuel filter, Cummins engine	105-19		
Rotary radiator screen	105-20	Service — Ground Speed Drive	
Flushing the cooling system	105-22	Brake system	120-1
Replacing coolant conditioner	105-33	Brake fluid reservoir	120-2
Drive belts	105-34	Adjusting foot brakes	120-2
Air intake system	105-39	Parking brake	120-2
Air intake prefilter screen	105-42	Hydrostatic drive components	120-3
Air cleaner element	105-42	Oil cooler	120-4
Turbocharger	105-47	Oil and filter change	120-4
Vibration damper	105-48	Transmission	120-5
		Front axle	120-7
Service — Electrical System		Rear-axle toe-in	120-7
Specifications	110-1	Steering system components	120-10
Batteries	110-1		
Alternators	110-5	Service — Air Conditioning System, Heater	
Starter motor	110-6	Air conditioning system components	125-1
Access to fuse board	110-7	Heater components	125-2
Fuse tester	110-7	Compressor	125-4
Access to circuit boards	110-7	Refrigerant level	125-4
Access to electronic control unit	110-9	Low pressure switch	125-5
Access to relay-and-diode board	110-9	High pressure switch	125-5
Sockets	110-10	Cleaning the condenser	125-6
Electronic system boards	110-12	Cab air filters	125-6
Fuse board — fuses	110-13	Air intake opening	125-8
Fuse board — relays	110-15	Condensed water drain hose	125-8
Shift relays	110-15		
Relay-and-diode board	110-16	Storage	
Solenoids	110-17	After the season	130-1
Electronic control unit	110-19	Taking forage harvester out of storage	130-3
Engine speed adjustment	110-20		
Sending unit for electronic control unit	110-21	Crime Prevention Tips	135-1
Error codes, automatic function control . . .	110-23		
Self test of engine electronic system	110-43	Specifications	140-1
Error codes, Cummins engine	110-44		
Work lights	110-54		
Clearance and turn signal lights, front	110-55		
Tail, stop and turn signal lights, rear	110-55		

Continued on next page

Contents

Page

Serial Numbers

Serial number plates	145-1
Serial numbers	145-2

Index

Contents

Identification Views



ZX012524

ZX012524 -UN-20AUG97



ZX012525

ZX012525 -UN-21AUG97

Safety

RECOGNIZE SAFETY INFORMATION

This is the safety-alert symbol. When you see this symbol on your machine or in this manual, be alert to the potential for personal injury.

Follow recommended precautions and safe operating practices.

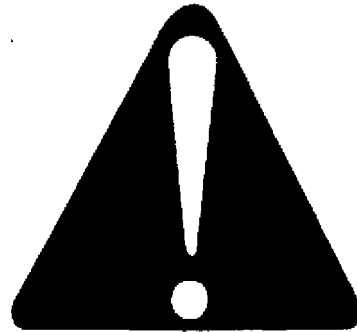

DX,ALERT -19-29SEP98

T81389 -UN-07DEC68

FOLLOW SAFETY INSTRUCTIONS

Carefully read all safety messages in this manual and on your machine safety signs. Keep safety signs in good condition. Replace missing or damaged safety signs. Be sure new equipment components and repair parts include the current safety signs. Replacement safety signs are available from your John Deere dealer.

Learn how to operate the machine and how to use controls properly. Do not let anyone operate without instruction.

Keep your machine in proper working condition. Unauthorized modifications to the machine may impair the function and/or safety and affect machine life.

If you do not understand any part of this manual and need assistance, contact your John Deere dealer.

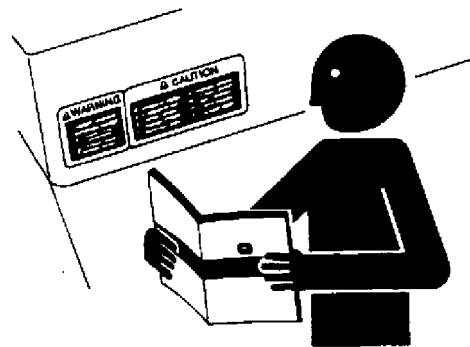

DX,READ -19-03MAR93

T5201 -UN-23AUG88

UNDERSTAND SIGNAL WORDS

A signal word—DANGER, WARNING, or CAUTION—is used with the safety-alert symbol. DANGER identifies the most serious hazards.

DANGER or WARNING safety signs are located near specific hazards. General precautions are listed on CAUTION safety signs. CAUTION also calls attention to safety messages in this manual.



DX,SIGNAL -19-03MAR93

T5187 -19-30SEP88



OBSERVE ROAD TRAFFIC REGULATIONS

Always observe local road traffic regulations when using public roads.



FX,ROAD -19-01MAY91

H28930 -UN-30JUN89

PREVENT MACHINE RUNAWAY

Avoid possible injury or death from machinery runaway.

Do not start engine by shorting across starter terminals. Machine will start in gear if normal circuitry is bypassed.

NEVER start engine while standing on ground. Start engine only from operator's seat, with transmission in neutral or park.

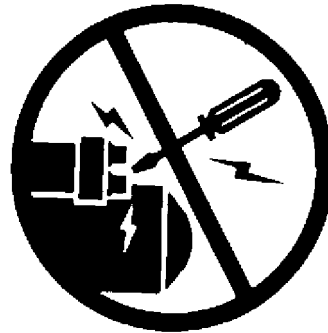

DX,BYPAS1 -19-29SEP98

TS177 -UN-11JAN69

USE SAFETY LIGHTS AND DEVICES

Prevent collisions between other road users, slow moving tractors with attachments or towed equipment, and self-propelled machines on public roads. Frequently check for traffic from the rear, especially in turns, and use hand signals or turn signal lights.

Use headlights, flashing warning lights, and turn signals day and night. Follow local regulations for equipment lighting and marking. Keep lighting and marking visible and in good working order. Replace or repair lighting and marking that has been damaged or lost.

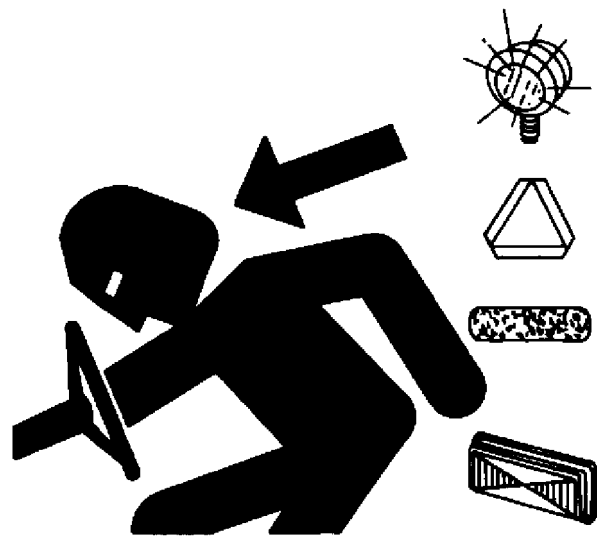

DX,FLASH -19-04FEB99

TS951 -UN-12APR90



HANDLE FUEL SAFELY—AVOID FIRES

Handle fuel with care: it is highly flammable. Do not refuel the machine while smoking or when near open flame or sparks.

Always stop engine before refueling machine. Fill fuel tank outdoors.

Prevent fires by keeping machine clean of accumulated trash, grease, and debris. Always clean up spilled fuel.



DX,FIRE1 -19-03MAR93

TS202
-UN-23AUG88

PREPARE FOR EMERGENCIES

Be prepared if a fire starts.

Keep a first aid kit and fire extinguisher handy.

Keep emergency numbers for doctors, ambulance service, hospital, and fire department near your telephone.

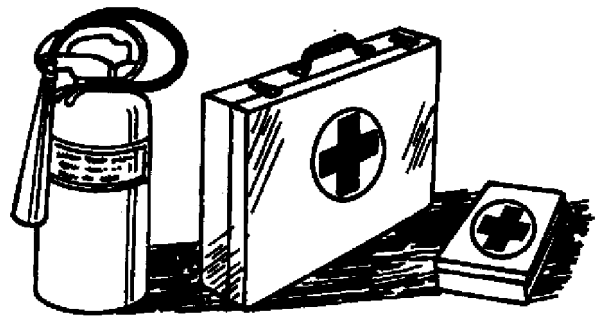

DX,FIRE2 -19-03MAR93

TS291
-UN-23AUG88

HANDLE STARTING FLUID SAFELY

Starting fluid is highly flammable.

Keep all sparks and flame away when using it. Keep starting fluid away from batteries and cables.

To prevent accidental discharge when storing the pressurized can, keep the cap on the container, and store in a cool, protected location.

Do not incinerate or puncture a starting fluid container.



DX,FIRE3 -19-16APR92

TS1356
-UN-18MAR92



WEAR PROTECTIVE CLOTHING

Wear close fitting clothing and safety equipment appropriate to the job.

Prolonged exposure to loud noise can cause impairment or loss of hearing.

Wear a suitable hearing protective device such as earmuffs or earplugs to protect against objectionable or uncomfortable loud noises.

Operating equipment safely requires the full attention of the operator. Do not wear radio or music headphones while operating machine.

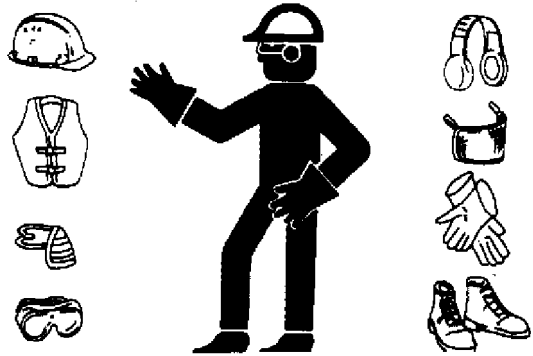

DX,WEAR -19-10SEP90

TS206 -UN-23AUG88

STORE ATTACHMENTS SAFELY

Stored attachments such as dual wheels, cage wheels, and loaders can fall and cause serious injury or death.

Securely store attachments and implements to prevent falling. Keep playing children and bystanders away from storage area.

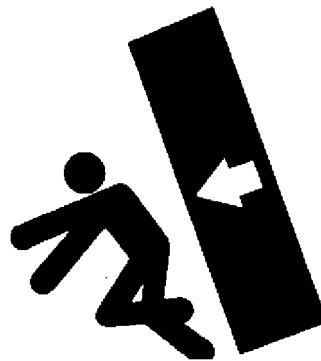

DX,STORE -19-03MAR93

TS219 -UN-23AUG88

MOUNT AND DISMOUNT SAFELY

Use handrail when mounting or dismounting the harvester.

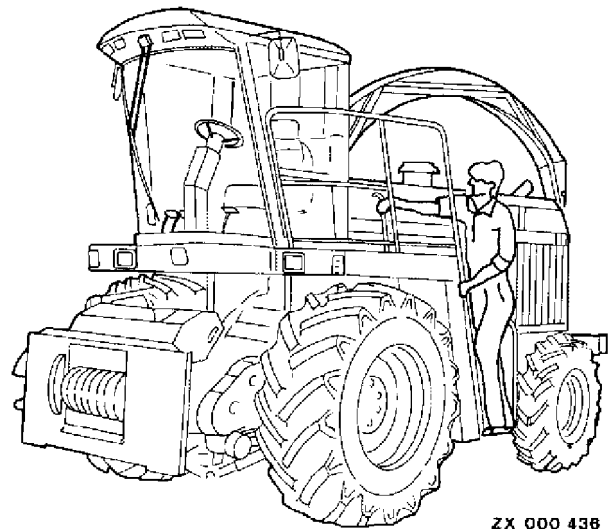

ZX 000 438

ZX,HANDLE -19-01OCT91

TS206 -UN-03APR95



OPERATE FORAGE HARVESTER SAFELY

All machinery should only be operated by persons who have been properly instructed.

Never stand in the path of discharge spout while cutterhead and fan are turning.

Never open cutterhead or fan housing doors while cutterhead is turning.

Always operate machine at rated engine speed.

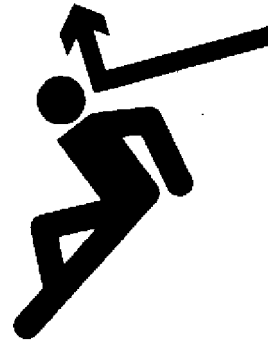

-UN-23AUG88

TS263

ZX,CAUTIONUS -19-01MAR93

WEAR SEAT-BELT

The machine operator and passenger should wear the seat-belt all times.

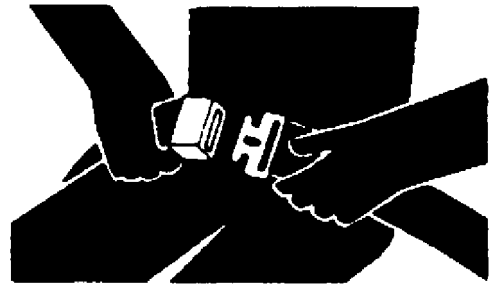

H47137

-UN-25OCT95

H47137

ZX,SEATBELT -19-01DEC96

KEEP RIDERS OFF THE MACHINE

Only allow the operator and one rider in the operator's station.

Other riders are subject to injury such as being thrown off the machine and obstruct the operator's view resulting in the machine being operated in an unsafe manner.

One rider is permitted, since the machine is equipped with a factory-approved passenger seat.



-UN-23AUG88

TS263

ZX,PASSENGERUS -19-01MAR93



DRIVING THE FORAGE HARVESTER

Operate machine only when all guards are correctly installed.

Before moving away, always check immediate vicinity of machine (e.g. for children). Ensure adequate visibility. Use the horn as a warning immediately before moving away.

Always adapt ground speed to road or field conditions. Avoid making sharp turns when driving up or down slopes or when driving across a slope.

Attach harvesting units and other implements to forage harvester with extreme care.

When making turns, always take into consideration the width of the attachment and the fact that the rear end of the forage harvester swings out. Attachments and ground conditions affect the driving characteristics of the harvester.

Reduce ground speed when driving on slopes or over uneven ground and before making sharp turns. Before descending a steep hill, shift to a lower gear.

Avoid holes, ditches and obstructions which may cause the forage harvester to tip, particularly on hillsides.

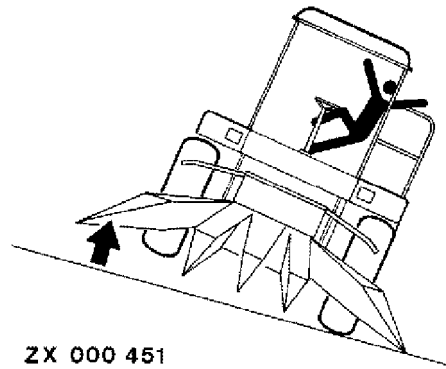

ZX 000 451

ZX000451 -JUN-05APR95

ZX,DRIVE -19-02OCT91

GUARDS AND SHIELDS

Keep guards and shields in place at all times. Ensure that they are serviceable and installed correctly.

Always disengage main clutch, shut off engine and remove key before removing any guards or shields.

Keep hands, feet and clothing away from moving parts.

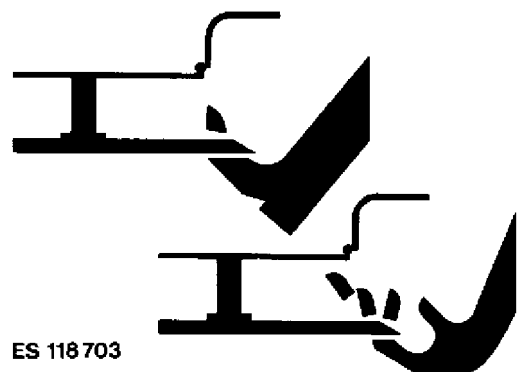

ES 118 703

ES118703 -JUN-21MAR95

FX,DEVICE -19-04DEC90



STAY CLEAR OF HARVESTING UNITS

Cutterbar, auger, reel and feed rolls cannot be completely shielded due to their function. Stay clear of these moving elements during operation. Always disengage main clutch, shut off engine and remove key before servicing or unclogging machine.



FX,CUT -19-21DEC90

ES118704 -UN-21MAR95

KEEP HANDS AWAY FROM KNIVES

Never attempt to clear obstructions in front of or on harvesting unit unless main clutch is disengaged, engine shut off and key removed.

Everyone must be clear of the forage harvester before starting the engine.



FX,KNIFE -19-21DEC90

-UN-23AUG88

TS254

STAY CLEAR OF ROTATING DRIVELINES

Entanglement in rotating driveline can cause serious injury or death.

Keep tractor master shield and driveline shields in place at all times. Make sure rotating shields turn freely.

Wear close fitting clothing. Stop the engine and be sure PTO driveline is stopped before making adjustments, connections, or cleaning out PTO driven equipment.



DX,PTO -19-12SEP95

-UN-22AUG95

TS1644

AVOID ENTANGLEMENT

To avoid entanglement, do not feed crop into machine by hand or attempt to manually unplug machine while it is running. The feed rolls can feed crop material in faster than you can release your grip on the material.

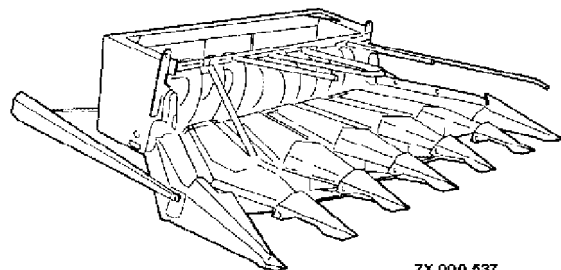

ZX,FEEDROLL -19-04DEC90

ZX000537 -UN-03APR95



TRANSPORT WITH HARVESTING UNIT INSTALLED

Before driving forage harvester on public roads, harvesting unit must be raised. It must not, however, obstruct the operator's view of the road.

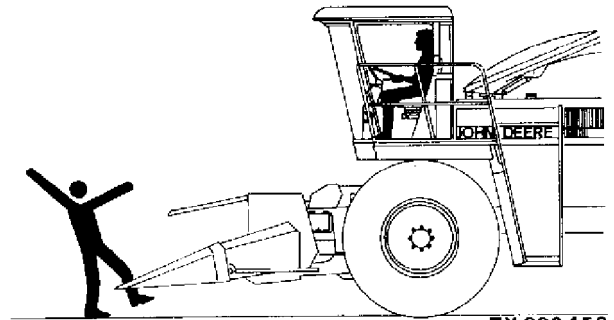

ZX 000 452

ZX_HEADERUS -19-01MAR93

-UN-03APR95
ZX000452

BALLASTING FOR SAFE GROUND CONTACT

Operating, steering and braking performance of forage harvester can be considerably affected by attachments which alter the center of gravity of the machine. To maintain safe ground contact, ballast the harvester at the rear end as necessary. Observe the maximum permissible axle loads and total weights.

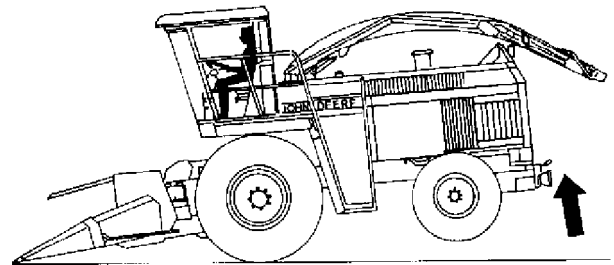

ZX 000 453

ZX_WEIGHT -19-02OCT91

-UN-03APR95
ZX000453

AVOID POWER LINES

If radio aerial and CB aerial (optional) are not secured in transport position before driving on public roads, they may come into contact with low-hanging electrical cables. This could result in the operator suffering a severe electrical shock.

To avoid electrical shock, no portion of the machine should be higher than 4 m (13 ft).

Before transporting machine, lower aerial or remove it.

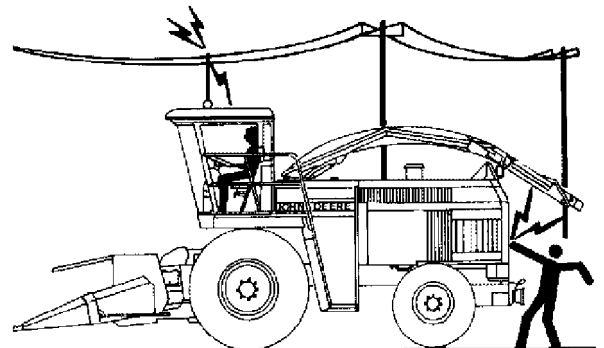

ZX 000 454

ZX_ANTENNAUS -19-01MAR93

-UN-03APR95
ZX000454



PARKING AND LEAVING THE FORAGE HARVESTER

Lower harvesting unit to the ground.

Before leaving the forage harvester, disengage main clutch and shut off engine. Move gear shift lever to neutral, apply parking brake, remove key and lock the operator's cab.

Never leave forage harvester unattended as long as engine is running.

Never leave the operator's cab when driving.

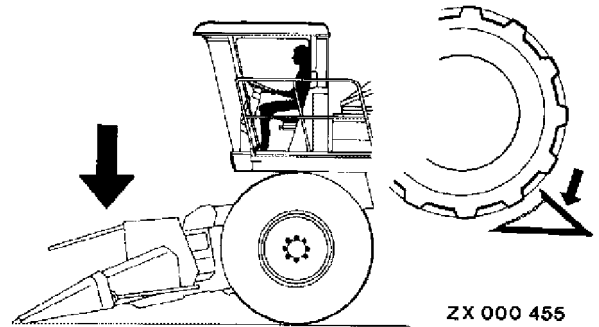

-UN-03APR95

ZX000455

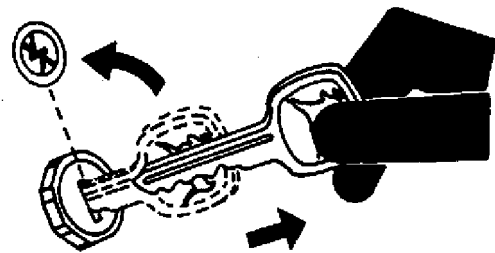

-UN-24MAY89

TS230

ZX_PARKUS -19-01JAN93

WORK IN VENTILATED AREA

Engine exhaust fumes can cause sickness or death. If it is necessary to run an engine in an enclosed area, remove the exhaust fumes from the area with an exhaust pipe extension.

If you do not have an exhaust pipe extension, open the doors and get outside air into the area.

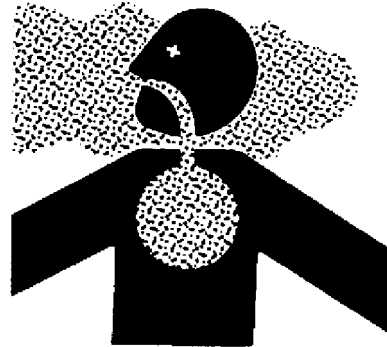

-UN-23AUG88

TS220

DX,AIR -19-04JUN90

EMERGENCY EXIT

The right-hand cab window may be used as an emergency exit. Disengage the gas-filled spring on the sidewall of the cab and open the window.

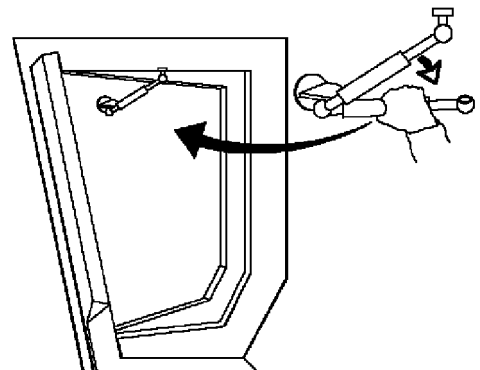

ZX 006004

-UN-03APR95

ZX006004

ZX,OMSPFH003293-19-01MAY94



PRACTICE SAFE MAINTENANCE

Understand service procedure before doing work. Keep area clean and dry.

Never lubricate, service, or adjust machine while it is moving. Keep hands, feet, and clothing from power-driven parts. Disengage all power and operate controls to relieve pressure. Lower equipment to the ground. Stop the engine. Remove the key. Allow machine to cool.

Securely support any machine elements that must be raised for service work.

Keep all parts in good condition and properly installed. Fix damage immediately. Replace worn or broken parts. Remove any buildup of grease, oil, or debris.

On self-propelled equipment, disconnect battery ground cable (-) before making adjustments on electrical systems or welding on machine.

On towed implements, disconnect wiring harnesses from tractor before servicing electrical system components or welding on machine.



DX,SERV -19-04FEB99

-UN-23AUG88
TSS218

SUPPORT MACHINE PROPERLY

Always lower the attachment or implement to the ground before you work on the machine. If you must work on a lifted machine or attachment, securely support the machine or attachment. If left in a raised position, hydraulically supported devices can settle or leak down.

Do not support the machine on cinder blocks, hollow tiles, or props that may crumble under continuous load. Do not work under a machine that is supported solely by a jack. Follow recommended procedures in this manual.

When implements or attachments are used with a tractor, always follow safety precautions listed in the implement operator's manual.

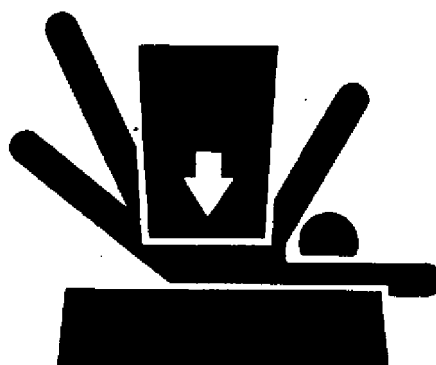

DX,LOWER -19-04FEB99

-UN-23AUG88
TSS229



RETORQUE WHEEL NUTS

Retorque wheel nuts as specified in Sections "Wheels and Ballast" and "Lubrication, Periodic Services". Failure to do this could result in a wheel falling off during operation, causing the machine to tip over with serious injury to the operator and extensive damage to the machine.

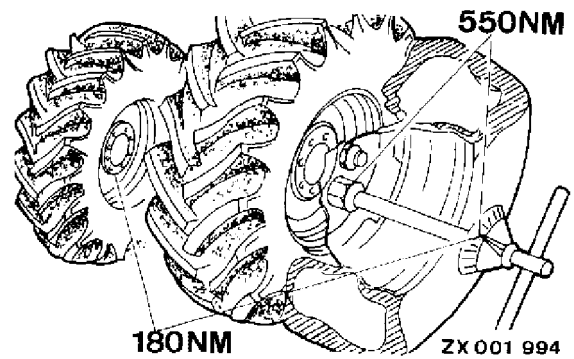

ZX.NUTSSPFH -19-01NOV97

-UN-03APR95
ZX001994

AVOID HIGH-PRESSURE FLUIDS

Escaping fluid under pressure can penetrate the skin causing serious injury.

Avoid the hazard by relieving pressure before disconnecting hydraulic or other lines. Tighten all connections before applying pressure.

Search for leaks with a piece of cardboard. Protect hands and body from high pressure fluids.

If an accident occurs, see a doctor immediately. Any fluid injected into the skin must be surgically removed within a few hours or gangrene may result. Doctors unfamiliar with this type of injury should reference a knowledgeable medical source. Such information is available from Deere & Company Medical Department in Moline, Illinois, U.S.A.

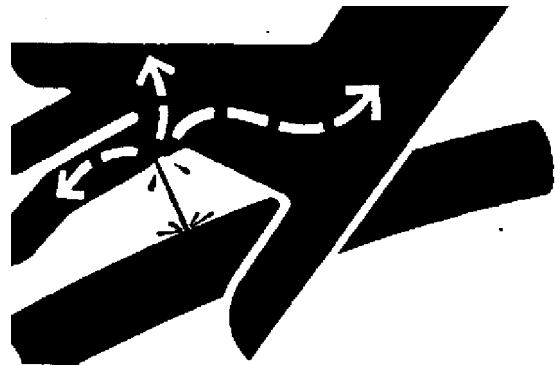

-UN-23AUG88
X9811

DX,FLUID -19-03MAR93

SERVICE COOLING SYSTEM SAFELY

Explosive release of fluids from pressurized cooling system can cause serious burns.

Shut off engine. Only remove filler cap when cool enough to touch with bare hands. Slowly loosen cap to first stop to relieve pressure before removing completely.



DX,RCAP -19-04JUN90

-UN-23AUG88
TS281



DISPOSE OF WASTE PROPERLY

Improperly disposing of waste can threaten the environment and ecology. Potentially harmful waste used with John Deere equipment include such items as oil, fuel, coolant, brake fluid, filters, and batteries.

Use leakproof containers when draining fluids. Do not use food or beverage containers that may mislead someone into drinking from them.

Do not pour waste onto the ground, down a drain, or into any water source.

Air conditioning refrigerants escaping into the air can damage the Earth's atmosphere. Government regulations may require a certified air conditioning service center to recover and recycle used air conditioning refrigerants.

Inquire on the proper way to recycle or dispose of waste from your local environmental or recycling center, or from your John Deere dealer.

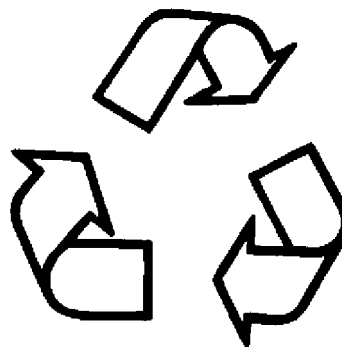

TS1133 -UN-26NOV90

DX,DRAIN -19-03MAR93

Safety Decals

WARNING

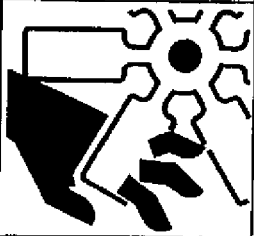

Avoid bodily injury from rotating engine fan: Keep hands out of fan discharge area when engine is running.

DANGER



Start only from seat in park or neutral. Starting in gear kills.





WARNING

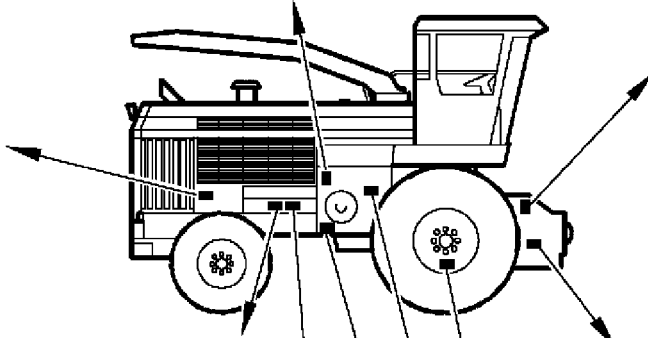

Avoid bodily injuries from rotating knives. Keep hands out of knife area when cutter head is turning.



DANGER/POISON

 <p>SHIELD EYES EXPLOSIVE GASES CAN CAUSE BLINDNESS OR INJURY</p>	 <p>NO SPARKS FLAMES SMOKING</p>	 <p>SULFURIC ACID CAN CAUSE BLINDNESS OR SEVERE BURNS</p>	<p>FLUSH EYES IMMEDIATELY WITH WATER</p>  <p>GET MEDICAL HELP FAST</p>
--	---	--	--

KEEP OUT OF THE REACH OF CHILDREN, DO NOT TIP, KEEP VENT CAPS TIGHT AND LFVFL

WARNING

Components behind guards or access doors in this area may rotate, possibly several minutes, after power is shut off.

To avoid bodily injury:

1. Look and listen for evidence of rotation.
2. Do not open or remove guard or access door until all components have stopped.

CAUTION

BOOSTER CABLE INSTRUCTIONS

1. ON A NEGATIVE GROUNDED SYSTEM CONNECT ENDS OF ONE CABLE TO POSITIVE (+) TERMINAL OF EACH BATTERY
2. CONNECT ONE END OF OTHER CABLE TO NEGATIVE (-) TERMINAL OF THE BOOSTER BATTERY
3. CONNECT THE OTHER END OF THE CABLE, AWAY FROM THE BATTERY, TO THE ENGINE BLOCK, FRAME, OR SOME OTHER GOOD METALLIC GROUND
4. REVERSE PROCEDURE WHEN DISCONNECTING

IMPORTANT

TORQUE WHEEL BOLTS TO 400 LB-FT (550 NM) RETORQUE AT LEAST ONCE AFTER ONE HOUR OF OPERATION EACH TIME THE WHEEL IS REPOSITIONED. EACH NEW WHEEL MUST ALSO BE RETORQUED.



WARNING

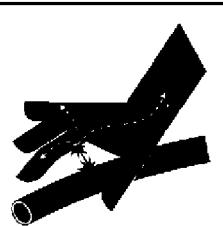

Avoid bodily injuries from hydraulic oil and gas under pressure. Before removing, disassembling or charging accumulator:

1. SWITCH IGNITION ON WITHOUT STARTING ENGINE
2. ACTUATE SLOWLY MAIN SWITCH FOR 25 ON-OFF CYCLES TO RELIEF SYSTEM HYDRAULIC PRESSURE
3. SWITCH IGNITION OFF

USE ONLY DRY NITROGEN FOR RECHARGING ACCUMULATOR. SEE YOUR JOHN DEERE DEALER.

WARNING

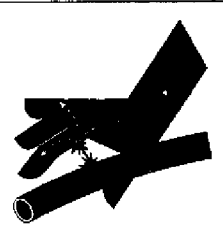

Avoid bodily injuries from hydraulic oil and gas under pressure. Before removing, disassembling or charging accumulator:

1. SWITCH ENGINE AND DEPRESS SWITCHES FOR HEADER DOWN AND FLOTATION DISCHARGING SIMULTANEOUSLY FOR 5 SECONDS AFTER ROLLERBOX OR HEADER IS ON THE GROUND OR IN A SUPPORTED POSITION TO RELIEF SYSTEM HYDRAULIC PRESSURE.
2. STOP ENGINE.

USE ONLY DRY NITROGEN FOR RECHARGING ACCUMULATOR. SEE YOUR JOHN DEERE DEALER.

ZX012542

ZX.STICKERUS1 -19-01NOV97



Suggest:

For more complete manuals. Please go to the home page.

<https://www.ebooklibonline.com>

If the above button click is invalid. Please download this document first, and then click the above link to download the complete manual.

Thank you so much for reading

SAFETY
live with it

WARNING

Be Safe--Avoid Bodily Injury

Before operating machine, add rear ballast as specified in Operator's Manual. Failure to add proper amount of ballast can result in vehicle instability and loss of steering control.

WARNING

Avoid bodily injury from rotating engine fan: Keep hands out of fan discharge area when engine is running.

DANGER!

ROTATING KNIVES CAN CAUSE SERIOUS INJURY OR DEATH.

NEVER OPERATE ENGINE WITH FEEDROLL HOUSING OPEN.

IMPORTANT

TORQUE WHEEL BOLTS TO 400 LB-FT (550 NM) RETORQUE AT LEAST ONCE AFTER ONE HOUR OF OPERATION EACH TIME THE WHEEL IS REPOSITIONED EACH NEW WHEEL MUST ALSO BE RETORQUED

CAUTION

1. Keep all shields in place.
2. Disengage and shut off all engine and/or motor power before servicing or unclogging machine.
3. Keep hands, feet, and clothing away from power-driven parts.

CAUTION

TO AVOID SERIOUS PERSONAL INJURY :

NEVER SEARCH FOR DETECTED METAL UNTIL YOU

1. DISENGAGE ALL DRIVES.
2. SHUT OFF THE ENGINE AND IGNITION SWITCH.
3. WAIT FOR ALL PARTS TO STOP MOVING. *

WARNING

AVOID BODILY INJURIES FROM HYDRAULIC OIL AND GAS UNDER PRESSURE.

BEFORE REMOVING, DISASSEMBLING OR CHARGING ACCUMULATOR :

1. SWITCH ENGINE AND DEPRESS SWITCHES FOR HEADER DOWN AND FLOTATION DISCHARGING SIMULTANEOUSLY FOR 5 SECOND AFTER ROLLERBOX OR HEADER IS ON THE GROUND OR IN A SUPPORTED POSITION TO RELIEF SYSTEM HYDRAULIC PRESSURE.
2. STOP ENGINE.

USE ONLY DRY NITROGEN FOR RECHARGING ACCUMULATOR. SEE YOUR JOHN DEERE DEALER.

ZX012543

ZX.STICKERUS2 -19-01NOV97

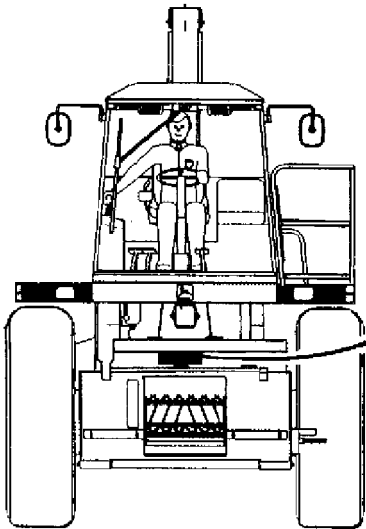

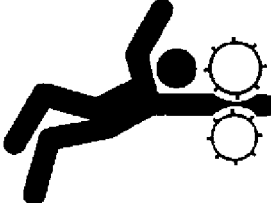

! DANGER

Avoid death or serious injury from entanglement in the feed rolls.

The harvester takes crop faster than you can release it.

NEVER feed with hands or feet or use as a manually-fed stationary machine.

Disengage drives and shut off engine before manually unplugging.

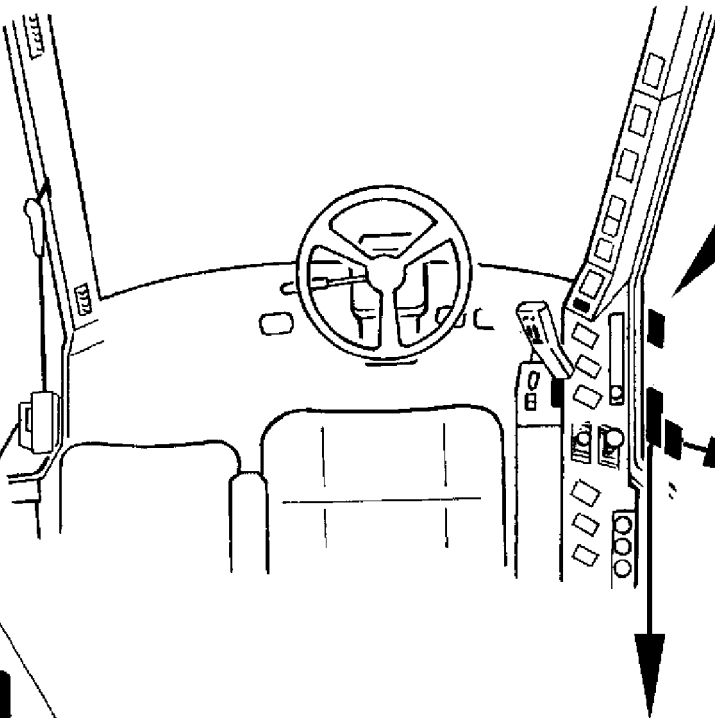

! CAUTION

Use the seat belt whenever you operate the machine or ride as an observer.

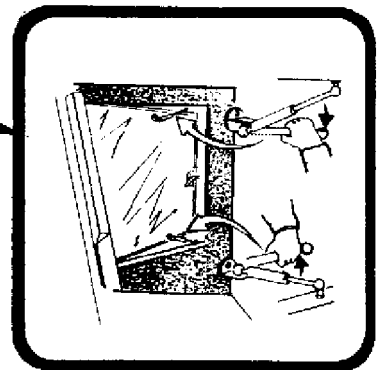



SAFETY

live with it

IMPORTANT

ENGINE WILL NOT START UNLESS HYDROSTATIC CONTROL LEVER IS IN NEUTRAL AND MAIN CLUTCH SWITCH IS OFF.

MAIN CLUTCH CANNOT BE ENGAGED UNLESS FEEDROLL HOUSING IS CLOSED AND HEADER SWITCH IS IN NEUTRAL.

ZX009979

ZX009979 -JUN-09DEC96

ZX.STICKERUS3 -19-01DEC96

<https://www.ebooklibonline.com>

Hello dear friend!

Thank you very much for reading.

Enter the link into your browser.

The full manual is available for immediate download.

<https://www.ebooklibonline.com>