

1418 Rotary Cutter



JOHN DEERE

OPERATORS MANUAL

1418
Rotary Cutter

OMW38938 Issue D8 English

John Deere Welland Works
OMW38938 Issue D8

LITHO IN U.S.A.
ENGLISH



Introduction

Read this manual carefully to learn how to operate and service your machine correctly. Failure to do so could result in personal injury or equipment damage.

This manual should be considered a permanent part of your machine and should remain with the machine when you sell it.

Measurements in this manual are U.S. customary units and their metric equivalents.

Right-hand and left-hand sides are determined by facing in the direction the implement will travel when going forward.

Write product identification numbers in the Specifications section. Accurately record all the numbers to help in tracing the machine should it be stolen. Your dealer also needs these numbers when you order parts. If this manual is kept on the machine, also file the identification numbers in a secure place off the machine.

Warranty is provided as part of John Deere's support program for customers who operate and maintain their equipment as described in this manual. The warranty is explained on the warranty certificate which you should have received from your dealer.

This warranty provides you the assurance that John Deere will back its products where defects appear within the warranty period. In some circumstances, John Deere also provides field improvements, often without charge to the customer, even if the product is out of warranty. Should the equipment be abused, or modified to change its performance beyond the original factory specifications, the warranty will become void and field improvements may be denied. Setting fuel delivery above specifications or otherwise overpowering machines will result in such action.

The tire manufacturer's warranty supplied with your machine may not apply outside the U.S.

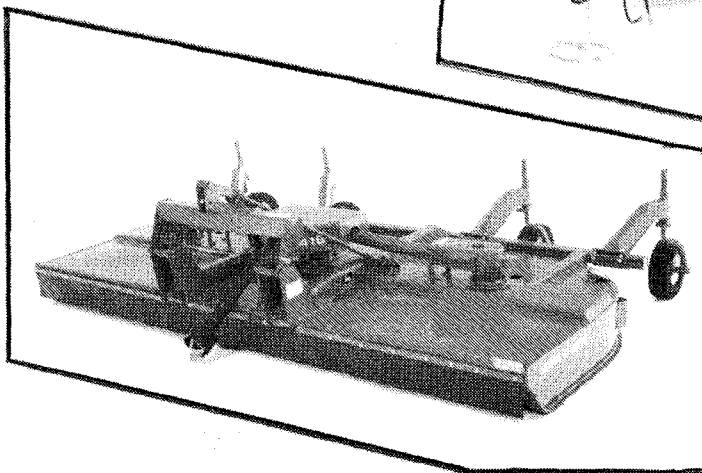
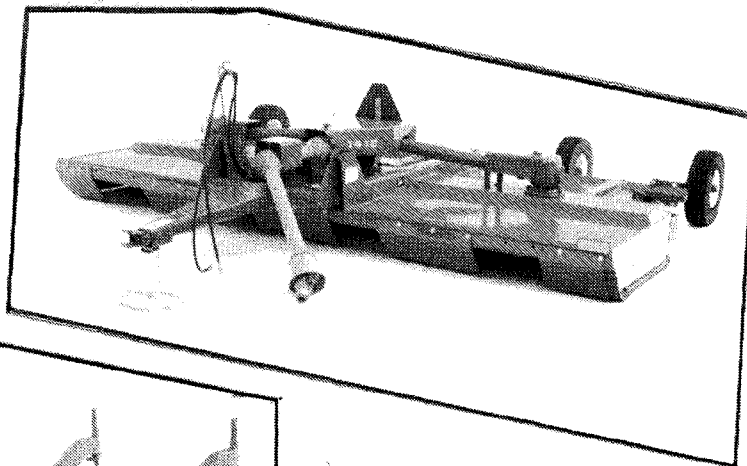

All information, illustrations and specifications in this manual are based on the latest product information available at the time of publication. The right is reserved to make changes at any time without notice.

Contents

	Page		Page
Safety	05-1	Detaching From 3-Point Hitch	35-2
Safety Signs	10-1	Detaching From Quick-Coupler	35-2
Preparing The Tractor		Avoid High Pressure Fluids	35-3
Matching PTO Speed	15-1	Detaching From Drawbar Pull-Type Cutter	35-3
Matching PTO Driveline And PTO Shaft	15-1	Transporting	40-1
Using Front Ballast	15-1	Operating The Cutter	
Selecting Tractor For Integral Cutter	15-2	Operating Safely	45-1
Positioning Drawbar	15-2	Using Safety Shields	45-1
Adjusting Rate Of Drop	15-3	Keeping Cutter Clean	45-2
Adjusting Hitch Sway Controls	15-3	Cutting Applications	45-2
Setting Lateral Float	15-3	Using Correct PTO Speed	45-2
Selecting Tractor For Pull-Type Cutter	15-3	Using Correct Blades	45-3
Positioning Drawbar	15-4	Removing Baffle	45-3
Removing Quick-Coupler	15-4	Checking The Slip Clutch	45-3
Selecting Hydraulic Flow	15-4	Turning Integral Cutter	45-4
Preparing The Cutter		Turning Pull-Type Cutter	45-4
Lubricating The Machine	20-1	Maintaining Cutting Angle	45-4
Inspecting Blades and Blade Holder	20-1	Adjusting Cutting Height, Integral Cutter	45-4
Inspecting Gear Case	20-1	Adjusting Cutting Height, Pull-Type Cutter	45-6
Checking Tires	20-2	Attachments	
Adjusting The Clutch	20-2	Front Safety Shields	50-1
Preparing Category 2, 3-Point Hitch	20-2	Attaching Front Shield	50-1
Preparing Category 3, 3-Point Hitch	20-2	Cotton Row Shields	50-2
Preparing Category 3N, 3-Point Hitch	20-3	Rear Safety Shields	50-2
Preparing Category 2, Quick-Coupler	20-3	Harrow Hitch	50-3
Preparing Category 3 and 3N, Quick-Coupler	20-3	Tires, Pull-Type Cutter	50-3
Hydraulic Cylinder Requirement	20-3	Wheel Supports, Pull-Type Cutter	50-3
Tightening Wheel And Wheel Support Hardware	20-4	Wheel Supports, Integral Cutter	50-4
Controls	25-1	Slow Moving Vehicle Emblem	50-5
Attaching The Cutter		Warning Lights	50-5
Matching PTO Driveline And PTO Shaft	30-1	Lubrication And Maintenance	
Attaching Cutter Safely	30-1	Lubricating Safely	55-1
Attaching Constant Velocity Driveline	30-1	Observing Intervals	55-1
Attaching To 3-Point Hitch	30-1	Selecting Grease	55-2
Attaching To Quick-Coupler	30-3	Selecting Gear Case Oil	55-2
Leveling The Machine	30-4	Lubricating Slip Clutch	55-3
Avoid High Pressure Fluids	30-4	Lubricating Pull-Type Driveline	55-3
Attaching To Drawbar	30-4	Lubricating Constant Velocity Joint	55-4
Connecting Warning Lights	30-5	Lubricating Integral Driveline	55-4
Detaching The Cutter		Lubricating Driveline Shield	55-5
Detaching The Cutter Safely	35-1	Lubricating Cross Shaft Driveline	55-5
Detaching Driveline	35-1	Lubricating Integral Axles And Wheels	55-5
Disconnecting Warning Lights	35-1	Lubricating Pull-Type Wheels	55-6
		Checking Gear Case Oil Level	55-6

<https://www.ebooklibonline.com>

Hello dear friend!

Thank you very much for reading.

Enter the link into your browser.

The full manual is available for immediate download.

<https://www.ebooklibonline.com>

Contents

	Page		Page
Checking Blade Hardware	55-6	Specifications	85-1
Checking Gear Case Hardware	55-8		
 Troubleshooting			
Blades	60-1		
Clutch	60-2		
Gear Case	60-2		
Driveline	60-3		
Operating	60-4		
 Service			
Servicing Safely	65-1		
Checking Bolt Torque	65-4		
Checking Driveline Length, Integral	65-5		
Checking Driveline Length, Pull-Type	65-5		
Removing Gear Case	65-6		
Center Gear Case Components	65-7		
Outer Gear Case Components	65-8		
Gear Case Specifications	65-9		
Adjusting Rolling Torque, Blade			
Holder Shaft	65-9		
Setting Preload	65-10		
Adjusting Backlash	65-10		
Replacing Gear Cases	65-11		
Inspecting Blades	65-11		
Removing Blades	65-12		
Replacing Flat Blades	65-12		
Replacing Suction Blades	65-12		
Installing Single Blades			
Blade Holder With Pan	65-13		
Straight Blade Holder Without Pan	65-13		
Offset Blade Holder	65-13		
Installing Dual Blades			
Straight Blade Holder	65-14		
Offset Blade Holder	65-14		
Removing Blade Holder	65-15		
Installing Blade Holder	65-16		
Shear Bolt Torque Limiter Components	65-16		
Checking Shear Bolt Torque Limiter	65-17		
Removing Shear Bolt Torque Limiter	65-17		
Replacing Shear Bolt Torque Limiter	65-17		
Timing Blade Holders	65-18		
Slip Clutch Components	65-19		
Dimensions	65-19		
Assembling Slip Clutch	65-20		
Adjusting Slip Clutch	65-21		
 Storage	 70-1		
 Crime Prevention	 75-1		
 Assembly	 80-1		

Safety

RECOGNIZE SAFETY INFORMATION

This is the safety-alert symbol. When you see this symbol on your machine or in this manual, be alert to the potential for personal injury.

Follow recommended precautions and safe operating practices.

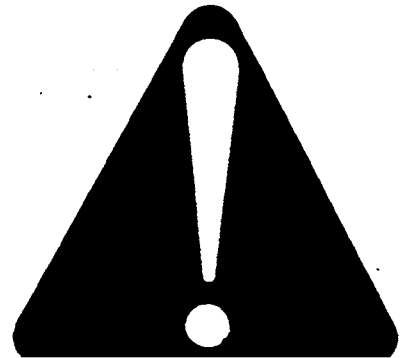

AB6;T81389 053;ALERT 160687

UNDERSTAND SIGNAL WORDS

A signal word—DANGER, WARNING, or CAUTION—is used with the safety-alert symbol. DANGER identifies the most serious hazards.

Safety signs with signal word DANGER or WARNING are typically near specific hazards.

General precautions are listed on CAUTION safety signs. CAUTION also calls attention to safety messages in this manual.

 **DANGER**

 **WARNING**

 **CAUTION**

AB6;TS187 053;SIGNAL 071085

FOLLOW SAFETY INSTRUCTIONS

Carefully read all safety messages in this manual and on your machine safety signs. Keep safety signs in good condition. Replace missing or damaged safety signs.

Learn how to operate the machine and how to use controls properly. Do not let anyone operate without instruction.

Keep your machine in proper working condition. Unauthorized modifications to the machine may impair the function and/or safety and affect machine life.

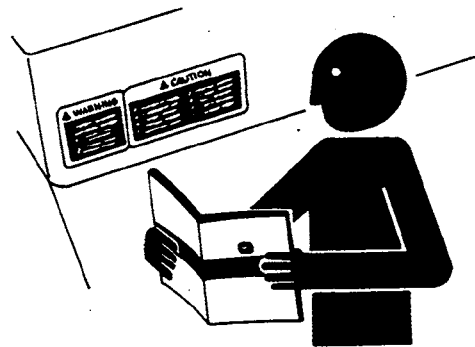

AB6;TS201 053;READ 230487

STAY CLEAR OF ROTATING DRIVELINE

Entanglement in rotating driveline can cause serious injury or death. Disengage PTO, engage parking brake or place transmission in "PARK", shut off tractor engine, and remove key before:

- Working around hitch
- Attaching or detaching driveline
- Making adjustments or servicing the machine
- Cleaning machine



4EA;W11251 W11;;SSY -B 220587



Suggest:

For more complete manuals. Please go to the home page.

<https://www.ebooklibonline.com>

If the above button click is invalid. Please download this document first, and then click the above link to download the complete manual.

Thank you so much for reading



CHECK BEFORE OPERATING

Check condition of hydraulic hoses and connections.

Become familiar with all controls.

Check hardware and machine condition.

Remove foreign objects from machine.

Be sure no one is near machine or tractor.

W11;;3SY -D 120188

STAY CLEAR OF ROTATING BLADES

Rotating blades can cut or dismember, causing personal injury or death. Keep hands and feet from under cutter deck.

Disconnect PTO driveline and hydraulic hoses from tractor before performing adjustments or service work.

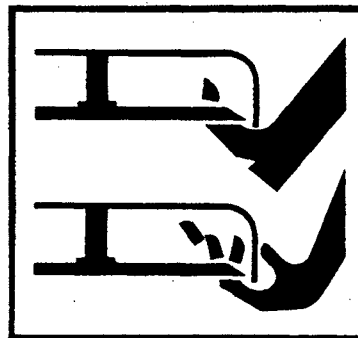

6DA;W14334 W11;;3SY -L 120188

USE FRONT AND REAR SAFETY SHIELDS

Use both front and rear safety shields to reduce the possibility of objects being thrown by the blades.

Adjustable rear shields should be kept in lowest possible position.

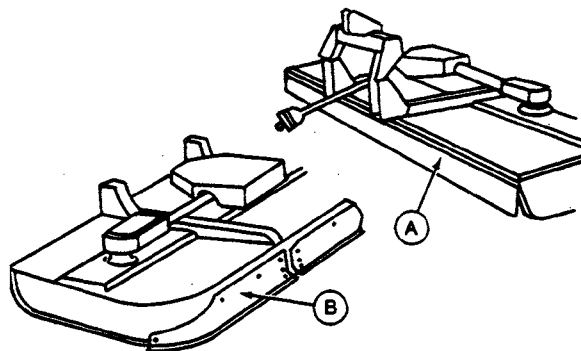

6DA;W11167 W11;;3SY -H 120188

PROTECT BYSTANDERS

Never operate the cutter near people. Do not stand near the cutter while blades are in motion. Debris can be thrown hundreds of feet.

DO NOT allow children to operate tractor or cutter.

Operate the cutter from tractor seat only.



6DA;W14335 W11;;3SY -F 120188



OPERATE TRACTOR AND CUTTER SAFELY

All rotary cutters are potentially dangerous machines. This rotary cutter has been designed to minimize the chance of accidents but there is no substitute for a careful operator.

Flywheel effect of blade holder will drive tractors with transmission driven PTO's forward, even when tractor clutch is disengaged. Travel slowly near ditches, trees, or large objects. To stop, slow engine speed and apply brakes before disengaging clutch.

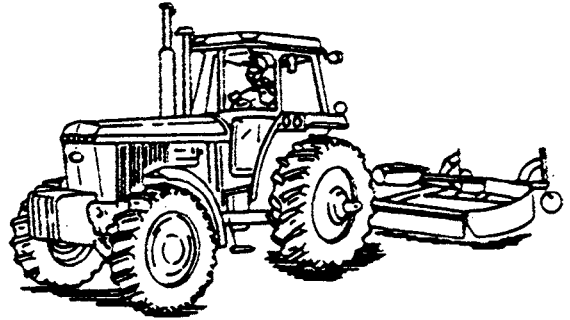

6DA;W11366 W11;;3SY -E 120188

BACK UP SAFELY

Do not operate the cutter in reverse unless necessary. First, look carefully behind the cutter.

Be very careful when you back the tractor with the PTO engaged. Material can be discharged from the front of the cutter. This increases risk of injury to the operator from thrown objects.

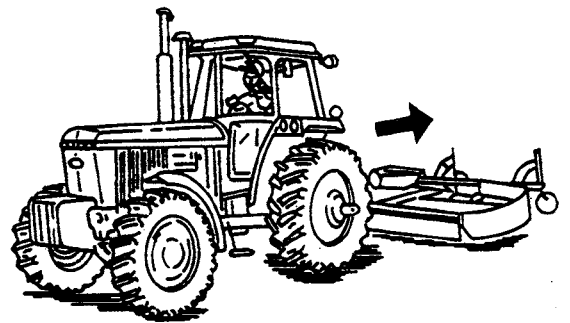

6DA;W11166 W11;;3SY -G 120188

LEAVING CUTTER UNATTENDED

Lower the cutter to the ground, disengage PTO, engage parking brake or place transmission in "PARK", shut off tractor, and remove key.

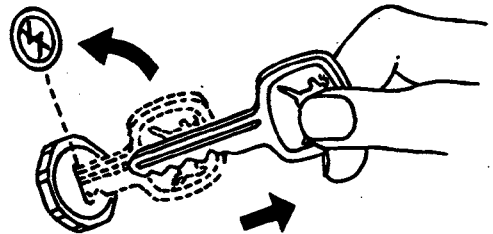

6DA;W9765 W11;;3SY -I 120188

KEEP RIDERS OFF MACHINE

Only allow the operator on the machine. Keep riders off.

Riders on machine are subject to injury such as being struck by foreign objects and being thrown off of the machine. Riders also obstruct the operator's view resulting in the machine being operated in an unsafe manner.



AB6;TS213 053;RIDER 160687

<https://www.ebooklibonline.com>

Hello dear friend!

Thank you very much for reading.

Enter the link into your browser.

The full manual is available for immediate download.

<https://www.ebooklibonline.com>