

PART No. EM16J – 2 – 1

Operator's Manual

ZAXIS

450

450H

450LC

450LCH

460LCH

Excavator

Serial No. 100001 and up

HITACHI

INDEX

MACHINE NUMBERS

SAFETY

SAFETY SIGNS

COMPONENTS NAME

GETTING ON/OFF THE MACHINE

OPERATOR'S STATION

BREAK-IN

OPERATING THE ENGINE

DRIVING THE MACHINE

OPERATING THE MACHINE

TRANSPORTING

MAINTENANCE

MAINTENANCE UNDER SPECIAL ENVIRONMENTAL CONDITIONS

STORAGE

TROUBLESHOOTING

SPECIFICATIONS

OPTIONAL ATTACHMENTS AND DEVICES

INDEX

MACHINE NUMBERS

The manufacturing Nos. explained in this group is the individual number (serial No.) given to each machine and hydraulic components. These numbers are requested when inquiring any information on the machine and/or components. Fill these serial Nos. in the blank spaces in this group to immediately make them available upon request.

MACHINE TYPE AND SERIAL NUMBER

MODEL/TYPE: _____

PRODUCT IDENTIFICATION NUMBER: _____

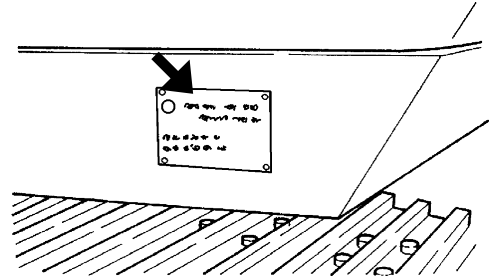

M157-00-001

PRODUCT IDENTIFICATION NUMBER

PRODUCT IDENTIFICATION NUMBER: _____

 NOTE:

16JP100001 Marks to indicate the start and end of the PIN
PRODUCT IDENTIFICATION NUMBER (PIN)

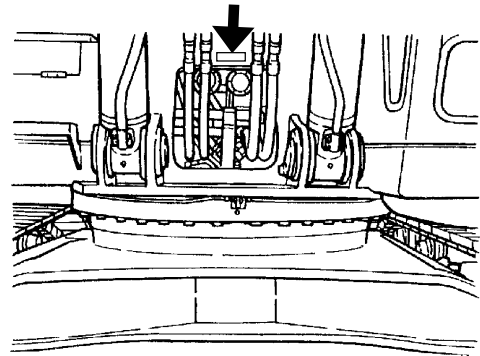

M111-07-010

ENGINE TYPE AND SERIAL NUMBER

TYPE: _____

MFG. NO.: _____

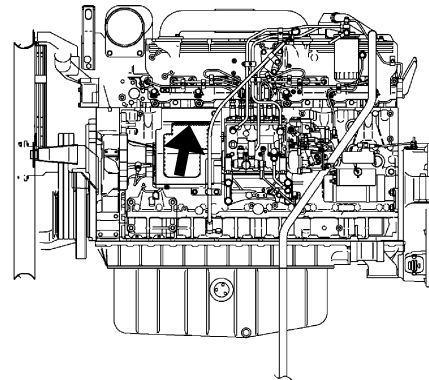

M16J-00-004

TRAVEL MOTOR TYPE AND SERIAL NUMBER

TYPE: _____

MFG. NO.: _____

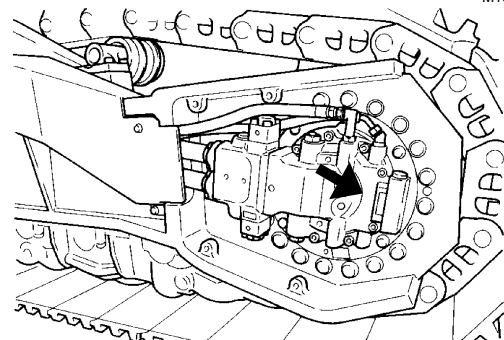

M111-12-007

<https://www.ebooklibonline.com>

Hello dear friend!

Thank you very much for reading.

Enter the link into your browser.

The full manual is available for immediate download.

<https://www.ebooklibonline.com>

MACHINE NUMBERS

SWING MOTOR TYPE AND SERIAL NUMBER

TYPE: _____

MFG. NO.: _____

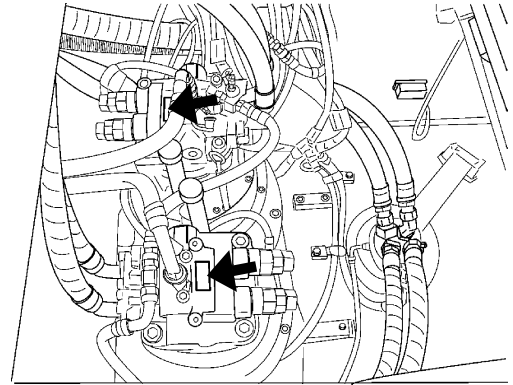

M16J-07-007

HYDRAULIC PUMP TYPE AND SERIAL NUMBER

TYPE: _____

MFG. NO.: _____

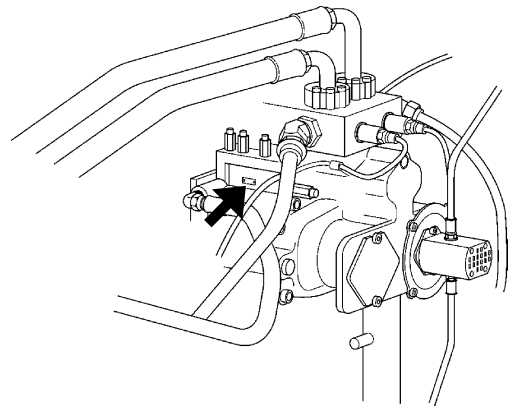

M16J-00-003

BOOM TYPE AND SERIAL NUMBER

TYPE: _____

MFG. NO.: _____

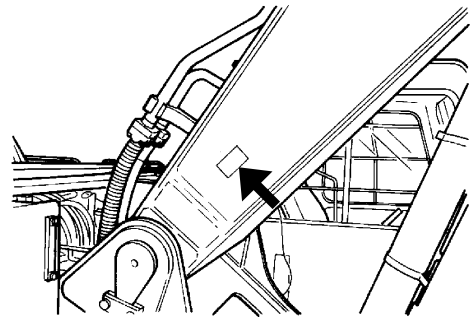

M111-12-005

ARM TYPE AND SERIAL NUMBER

TYPE: _____

MFG. NO.: _____

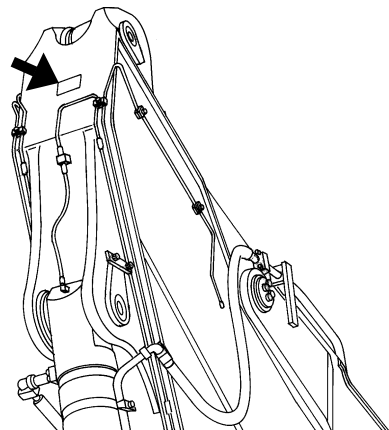

M111-12-006

MACHINE NUMBERS

BUCKET TYPE AND SERIAL NUMBER

TYPE: _____

MFG. NO.: _____

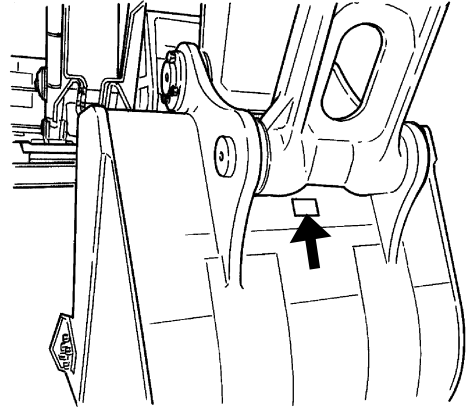

M116-12-004

CONTENTS

MACHINE NUMBERS

SAFETY

Recognize Safety Information	S-1
Understand Signal Words	S-1
Follow Safety Instructions	S-2
Prepare for Emergencies	S-2
Wear Protective Clothing	S-3
Protect Against Noise	S-3
Inspect Machine	S-3
General Precautions for Cab	S-4
Use Handholds and Steps	S-5
Adjust the Operator's Seat	S-5
Fasten Your Seat Belt	S-6
Move and Operate Machine Safely	S-6
Operate Only from Operator's Seat	S-7
Jump Starting	S-7
Keep Riders off Machine	S-7
Investigate Job Site Beforehand	S-8
Protect Against Falling Stones and Debris	S-8
Provide Signals for Jobs Involving Multiple Numbers of Machines	S-9
Confirm Direction of Machine to be Driven	S-9
Drive Machine Safely	S-10
Avoid Injury from Rollaway Accidents	S-11
Avoid Injury from Back-Over and Swing Accidents	S-12
Keep Person Clear from Working Area	S-13
Never Position Bucket Over Anyone	S-13
Avoid Undercutting	S-13
Avoid Tipping	S-14
Never Undercut A High Bank	S-14
Dig with Caution	S-15
Operate With Caution	S-15
Avoid Power Lines	S-15
Object Handling	S-16
Protect Against Flying Debris	S-16
Park Machine Safely	S-17
Handle Fluids Safely-Avoid Fires	S-17
Practice Safe Maintenance	S-18
Warn Others of Service Work	S-19
Support Machine Properly	S-19
Stay Clear of Moving Parts	S-19
Prevent Parts from Flying	S-20
Store Attachments Safely	S-20
Prevent Burns	S-21
Replace Rubber Hoses Periodically	S-21
Avoid High-Pressure Fluids	S-22
Prevent Fires	S-23
Evacuating in Case of Fire	S-24
Beware of Exhaust Fumes	S-24
Precautions for Welding and Grinding	S-25
Avoid Heating Near Pressurized Fluid Lines	S-26
Avoid Applying Heat to Lines Containing Flammable Fluids	S-26
Remove Paint Before Welding or Heating	S-26
Prevent Battery Explosions	S-27

Service Air Conditioning System Safely	S-27
Handle Chemical Products Safely	S-28
Dispose of Waste Properly	S-28

SAFETY SIGNS

COMPONENTS NAME

GETTING ON/OFF THE MACHINE

OPERATOR'S STATION

Cab Features	1-3
Monitor Panel	1-4
Coolant Temperature Gauge	1-5
Fuel Gauge	1-5
Auto-Idle Indicator	1-5
Auto-Acceleration Indicator	1-5
Fuel Level Indicator	1-6
Air Filter Restriction Indicator	1-6
Overheat Indicator	1-6
Engine Oil Pressure Indicator	1-6
Alternator Indicator	1-6
Engine Oil Level Indicator	1-7
Coolant Level Indicator	1-7
Preheat Indicator	1-7
Preciston Mode Indicator	1-7
Auto-Lubrication Indicator	1-7
Liquid Crystal Display (LCD)	1-8
Display Selection Switch	1-8
Hour Meter	1-8
Trip Meter 1 and Trip Meter 2	1-9
User's Mode	1-9
Set Switch	1-10
Work Mode Switch	1-11
Switch Panel	1-12
Engine Control Dial	1-12
Auto-Idle/Acceleration Selector	1-13
Power Mode Switch	1-14
Travel Mode Switch	1-14
Work Light Switch	1-15
Wiper/Washer Switch ZAXIS450, 450LC, 460LCH	1-16
Wiper/Washer Switch ZAXIS450H, 450LCH ..	1-17
Switch Panel (Optional)	1-18
Key Switch	1-21
Power Boost Switch	1-21
Horn Switch	1-21
Lighter	1-22
12-V Power Source (Optional)	1-23
Cab Light	1-24
Installing Fire Extinguisher	1-24
Pilot Control Shut-Off Lever	1-25
Engine Stop Knob	1-25
Fuse Box	1-26
Additional Fuse Box (Optional)	1-26
Air Conditioner Operation	1-27
Auto Air Conditioner	1-28

CONTENTS

Cab Heater Operation	1-34
Cooling Operation	1-34
Defroster Operation.....	1-35
Tips for Optimal Air Conditioner Usage.....	1-36
Cab Heater (Optional)	1-38
Cab Heater Operation	1-39
Defroster Operation.....	1-40
AM/FM Radio Operation.....	1-41
Digital Clock Setting Procedure.....	1-42
AM/FM Radio Operation.....	1-43
Digital Clock Setting Procedure.....	1-44
Cab Door Release Lever.....	1-45
Opening Upper Front Window (ZAXIS450, 450LC, 460LCH).....	1-45
Closing Upper Front Window (ZAXIS450, 450LC, 460LCH).....	1-46
Removing and Storing Lower Front Window (ZAXIS450, 450LC, 460LCH).....	1-47
Opening Side Windows (ZAXIS450, 450LC, 460LCH).....	1-48
Opening/Closing Overhead Window (ZAXIS450, 450LC, 460LCH).....	1-49
Adjusting the Seat	1-50
Seat with a Built-In Heater (Optional).....	1-51
Adjusting Console Height.....	1-52
Adjusting the Air-Suspension Seat (Optional)...	1-53
Seat with a Built-In Heater (Optional).....	1-54
Seat Belt.....	1-55
Emergency Exit (ZAXIS450, 450LC, 460LCH).....	1-56
Headguard-Integrated Cab.....	1-57
Emergency Exit (Headguard-Integrated Cab)...	1-58

BREAK-IN

Observe Engine Operation Closely	2-1
Every Eight Hours or Daily	2-1
After The First 50 Hours.....	2-1
After The First 100 Hours.....	2-1

OPERATING THE ENGINE

Inspect Machine Daily Before Starting	3-1
Before Starting Engine	3-2
Level Check.....	3-3
Starting the Engine.....	3-4
Starting in Cold Weather	3-5
Check Instruments After Starting	3-6
Using Booster Batteries.....	3-7
Stopping the Engine	3-9

DRIVING THE MACHINE

Drive the Machine Carefully	4-1
Steering the Machine Using Pedals	4-2
Steering the Machine Using Levers	4-3
Travel Mode Switch.....	4-4
Travel Alarm (Optional).....	4-4
Traveling.....	4-5
Operating on Soft Ground	4-6

Raise One Track Using Boom and Arm	4-6
Towing Machine a Short Distance	4-7
Operating in Water or Mud	4-8
Precautions for Traveling on Slopes.....	4-9
Parking the Machine on Slopes	4-10
Parking the Machine	4-10

OPERATING THE MACHINE

Control Lever (ISO Pattern)	5-1
Control Lever (HITACHI Pattern)	5-2
Control Lever (HITACHI Pattern Loading Shovel) ...	5-3
Control Lever (ISO Pattern Loading Shovel)	5-4
Bucket Open-Close Pedals (Loading Shovel)	5-5
Pilot Control Shut-Off Lever.....	5-6
Engine Speed Control.....	5-9
Auto-Idle.....	5-10
Auto Acceleration.....	5-11
Work Mode	5-13
Power Boost.....	5-13
Power Mode.....	5-14
Precautions for Operations	5-15
Operate the Machine Safely	5-16
Operating Backhoe	5-17
Grading Operation	5-17
Face Shovel Operation	5-18
Avoid Abusive Operation	5-18
Operating Tips	5-19
Select Correct Track Shoes.....	5-19
Precaution for Arm Roll-In/ Bucket Roll-In Combined Operation	5-20
Loading Shovel Operation	5-21
Straight Retraction Operation	5-21
Prohibited Operations (Loading Shovel).....	5-22
Precautions for Operation (Loading Shovel).....	5-24
Object Handling --- If Equipped	5-25
Electronic Control System Bypass Procedure ...	5-27
Overnight Storage Instructions	5-28

TRANSPORTING

Transporting by Road	6-1
Transporting the Machine by Trailer	6-1
Loading/Unloading on a Trailer.....	6-1
Backhoe (ZAXIS450).....	6-5
Backhoe (ZAXIS450H)	6-8
Backhoe (ZAXIS450LC)	6-11
Backhoe (ZAXIS450LCH).....	6-14
Backhoe (ZAXIS460LCH).....	6-17
Loading Shovel (ZAXIS450)	6-20
Retracting or Extending the Side Frame.....	6-24
Retracting the Side Frame (ZAXIS450LC, ZAXIS450LCH, ZAXIS460LCH)	6-25
Extending the Side Frame (ZAXIS450LC, ZAXIS450LCH, ZAXIS460LCH)	6-26

MAINTENANCE

Correct Maintenance and Inspection Procedures	7-1
---	-----

CONTENTS

Hydraulic System.....	11-9
-----------------------	------

SPECIFICATIONS

ZAXIS450, ZAXIS450LC (Backhoe)	
Specifications	12-1
Working Ranges	12-2
Shoe Types and Applications.....	12-3
Bucket Types and Applications	12-4
ZAXIS450H, ZAXIS450LCH (Backhoe)	
Specifications	12-5
Working Ranges	12-6
Shoe Types and Applications.....	12-7
Bucket Types and Applications	12-8
ZAXIS460LCH (Backhoe)	
Specifications	12-9
Working Ranges	12-10
Shoe Types and Applications.....	12-11
Bucket Types and Applications	12-12
ZAXIS450, 450H (Loading Shovel)	
Specifications	12-13
Working Ranges	12-15
Bucket Types and Applications	12-16
Lifting Capacities (ZX460LCH).....	12-17
Sound Level Results (2000/14/EC).....	12-21

OPTIONAL ATTACHMENTS AND DEVICES

Hydraulic Breaker.....	13-1
Breaker Operation.....	13-2
Precautions for Breaker Operation.....	13-4
Breaker Maintenance	13-8
Replace Breaker Circuit Return Oil Filter	13-10
Hydraulic Crusher.....	13-11
Stop Valve Operation	13-12
Three-Way-Valve Operation	13-13
Flow Combining Valve Operation	13-13
Precautions for Crusher Operation	13-14
Electronic Key Lock Operation Manual	13-16
Registration/Registration Cancellation of Ordinary Operation Key.....	13-19
Additional Registration Procedure.....	13-20
Registration Cancellation Procedure.....	13-21
Hydraulic Type Quick Hitch (ZAXIS460LCH) ..	13-22

INDEX	14-1
--------------------	------

SAFETY

RECOGNIZE SAFETY INFORMATION

- These are the **SAFETY ALERT SYMBOLS**.
 - When you see these symbols on your machine or in this manual, be alert to the potential for personal injury.
 - Follow recommended precautions and safe operating practices.

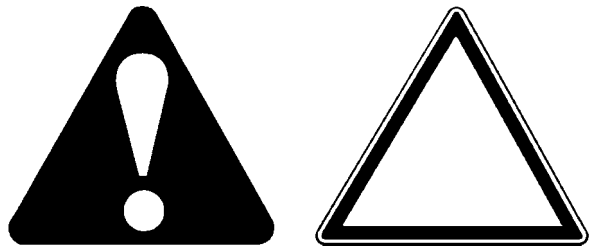

SA-688

001-E01A-0001

UNDERSTAND SIGNAL WORDS

- On machine safety signs, signal words designating the degree or level of hazard - **DANGER**, **WARNING**, or **CAUTION** - are used with the safety alert symbol.
 - **DANGER** indicates an imminently hazardous situation which, if not avoided, will result in death or serious injury.
 - **WARNING** indicates a potentially hazardous situation which, if not avoided, could result in death or serious injury.
 - **CAUTION** indicates a potentially hazardous situation which, if not avoided, may result in minor or moderate injury.
 - **DANGER** or **WARNING** safety signs are located near specific hazards. General precautions are listed on **CAUTION** safety signs.
 - Some safety signs don't use any of the designated signal words above after the safety alert symbol are occasionally used on this machine.
-
- **CAUTION** also calls attention to safety messages in this manual.
- To avoid confusing machine protection with personal safety messages, a signal word **IMPORTANT** indicates a situation which, if not avoided, could result in damage to the machine.
-  **NOTE** indicates an additional explanation for an element of information.



IMPORTANT



SA-1223

002-E01A-1223

SAFETY

FOLLOW SAFETY INSTRUCTIONS

- Carefully read and follow all safety signs on the machine and all safety messages in this manual.
- Safety signs should be installed, maintained and replaced when necessary.
 - If a safety sign or this manual is damaged or missing, order a replacement from your authorized dealer in the same way you order other replacement parts (be sure to state machine model and serial number when ordering).
- Learn how to operate the machine and its controls correctly and safely.
- Allow only trained, qualified, authorized personnel to operate the machine.
- Keep your machine in proper working condition.
 - Unauthorized modifications of the machine may impair its function and/or safety and affect machine life.
- The safety messages in this SAFETY chapter are intended to illustrate basic safety procedures of machines. However it is impossible for these safety messages to cover every hazardous situation you may encounter. If you have any questions, you should first consult your supervisor and/or your authorized dealer before operating or performing maintenance work on the machine.

003-E01B-0003

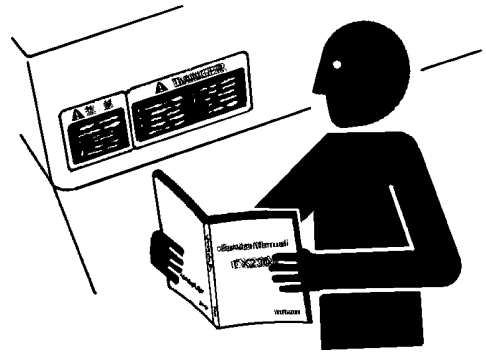

SA-003

PREPARE FOR EMERGENCIES

- Be prepared if a fire starts or if an accident occurs.
 - Keep a first aid kit and fire extinguisher on hand.
 - Thoroughly read and understand the label attached on the fire extinguisher to use it properly.
 - To ensure that a fire-extinguisher can be always used when necessary, check and service the fire-extinguisher at the recommended intervals as specified in the fire-extinguisher manual.
- Establish emergency procedure guidelines to cope with fires and accidents.
- Keep emergency numbers for doctors, ambulance service, hospital, and fire department posted near your telephone.

004-E01A-0437



SA-437

SAFETY

WEAR PROTECTIVE CLOTHING

- Wear close fitting clothing and safety equipment appropriate to the job.

You may need:

- A hard hat
- Safety shoes
- Safety glasses, goggles, or face shield
- Heavy gloves
- Hearing protection
- Reflective clothing
- Wet weather gear
- Respirator or filter mask.

Be sure to wear the correct equipment and clothing for the job. Do not take any chances.

- Avoid wearing loose clothing, jewelry, or other items that can catch on control levers or other parts of the machine.
- Operating equipment safely requires the full attention of the operator. Do not wear radio or music headphones while operating the machine.

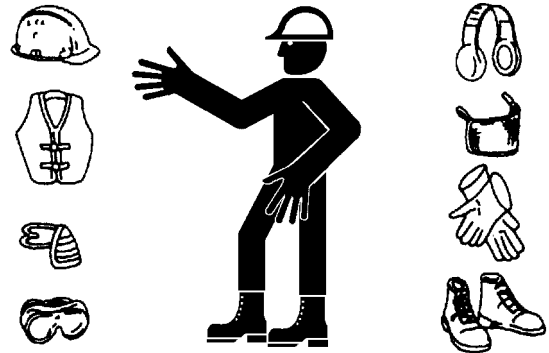

SA-438

005-E01A-0438

PROTECT AGAINST NOISE

- Prolonged exposure to loud noise can cause impairment or loss of hearing.
- Wear a suitable hearing protective device such as earmuffs or earplugs to protect against objectionable or uncomfortably loud noises.



006-E01A-0434

SA-434

INSPECT MACHINE

- Inspect your machine carefully each day or shift by walking around it before you start it to avoid personal injury.
- In the walk-around inspection, be sure to cover all points described in the “PRE-START INSPECTION” chapter in the operator’s manual.



007-E01A-0435

SA-435

SAFETY

GENERAL PRECAUTIONS FOR CAB

- Before entering the cab, thoroughly remove all dirt and/or oil from the soles of your work boots. If any controls such as a pedal is operated while with dirt and/or oil on the soles of the operator's work boots the operator's foot may slip off the pedal, possibly resulting in a personal accident.
- Don't leave parts and/or tools lying around the operator's seat. Store them in their specified locations.
- Avoid storing transparent bottles in the cab. Don't attach any transparent type window decorations on the windowpanes as they may focus sunlight, possibly starting a fire.
- Refrain from listening to the radio, or using music headphones or mobile telephones in the cab while operating the machine.
- Keep all flammable objects and/or explosives away from the machine.
- After using the ashtray, always cover it to extinguish the match and/or tobacco.
- Don't leave cigarette lighters in the cab. When the temperature in the cab increases, the lighter may explode.

524-E01A-0000

SAFETY

USE HANDHOLDS AND STEPS

- Falling is one of the major causes of personal injury.
 - When you get on and off the machine, always face the machine and maintain a three-point contact with the steps and handrails.
 - Do not use any controls as handholds.
 - Never jump on or off the machine. Never mount or dismount a moving machine.
 - Be careful of slippery conditions on platforms, steps, and handrails when leaving the machine.

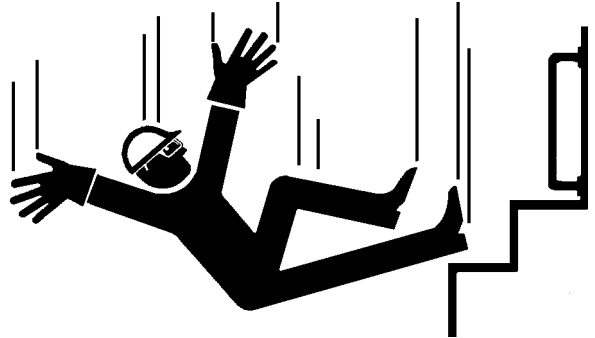

SA-439

008-E01A-0439

ADJUST THE OPERATOR'S SEAT

- A poorly adjusted seat for either the operator or for the work at hand may quickly fatigue the operator leading to misoperations.
 - The seat should be adjusted whenever changing the operator for the machine.
 - The operator should be able to fully depress the pedals and to correctly operate the control levers with his back against the seat back.
 - If not, move the seat forward or backward, and check again.



SA-378

009-E01A-0378

SAFETY

FASTEN YOUR SEAT BELT

- If the machine should overturn, the operator may become injured and/or thrown from the cab. Additionally the operator may be crushed by the overturning machine, resulting in serious injury or death.
- Prior to operating the machine, thoroughly examine webbing, buckle and attaching hardware. If any item is damaged or worn, replace the seat belt or component before operating the machine.
- Be sure to remain seated with the seat belt securely fastened at all times when the machine is in operation to minimize the chance of injury from an accident.
- We recommend that the seat belt be replaced every three years regardless of its apparent condition.

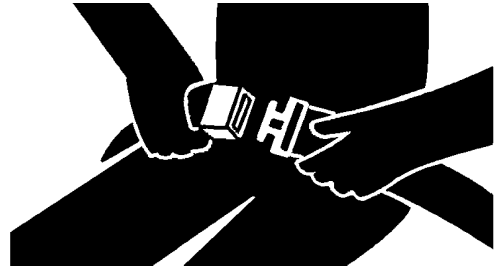

SA-237

010-E01A-0237

MOVE AND OPERATE MACHINE SAFELY

- Bystanders can be run over.
- Take extra care not to run over bystanders. Confirm the location of bystanders before moving, swinging, or operating the machine.
- Always keep the travel alarm and horn in working condition (if equipped). It warns people when the machine starts to move.
- Use a signal person when moving, swinging, or operating the machine in congested areas. Coordinate hand signals before starting the machine.

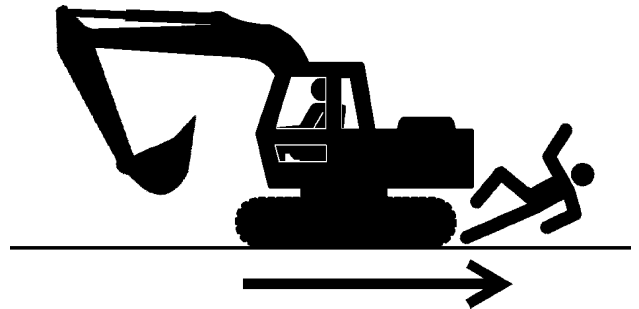

SA-426

011-E01A-0426

SAFETY

OPERATE ONLY FROM OPERATOR'S SEAT

- Inappropriate engine starting procedures may cause the machine to runaway, possibly resulting in serious injury or death.
- Start the engine only from the operator's seat.
- NEVER start the engine while standing on the track or on ground.
- Do not start engine by shorting across starter terminals.
- Before starting the engine, confirm that all control levers are in neutral.



SA-444

012-E01B-0444

JUMP STARTING

- Battery gas can explode, resulting in serious injury.
- If the engine must be jump started, be sure to follow the instructions shown in the "OPERATING THE ENGINE" chapter.
- The operator must be in the operator's seat so that the machine will be under control when the engine starts. Jump starting is a two-person operation.
- Never use a frozen battery.
- Failure to follow correct jump starting procedures could result in a battery explosion or a runaway machine.

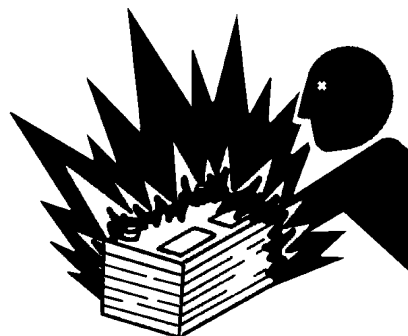

SA-032

S013-E01A-0032

KEEP RIDERS OFF MACHINE

- Riders on machine are subject to injury such as being struck by foreign objects and being thrown off the machine.
- Only allow the operator on the machine. Keep riders off.
- Riders also obstruct the operator's view, resulting in the machine being operated in an unsafe manner.

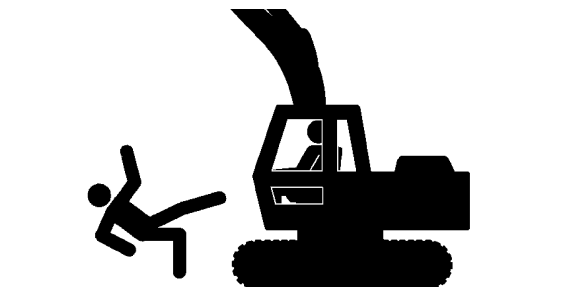

SA-379

014-E01B-0379

SAFETY

INVESTIGATE JOB SITE BEFOREHAND

- When working at the edge of an excavation or on a road shoulder, the machine could tip over, possibly resulting in serious injury or death.
- Investigate the configuration and ground conditions of the job site beforehand to prevent the machine from falling and to prevent the ground, stockpiles, or banks from collapsing.
- Make a work plan. Use machines appropriate to the work and job site.
- Reinforce ground, edges, and road shoulders as necessary. Keep the machine well back from the edges of excavations and road shoulders.
- When working on an incline or on a road shoulder, employ a signal person as required.
- Confirm that your machine is equipped a FOPS cab before working in areas where the possibility of falling stones or debris exist.
- When the footing is weak, reinforce the ground before starting work.
- When working on frozen ground, be extremely alert. As ambient temperatures rise, footing becomes loose and slippery.
- Beware the possibility of fire when operating the machine near flammable objects such as dry grass.

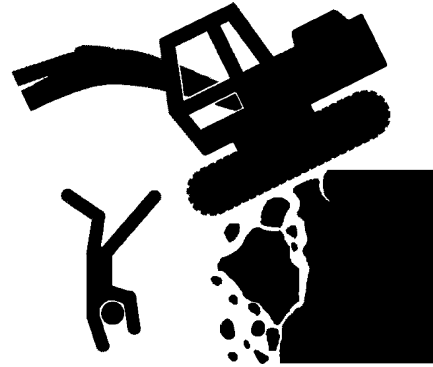

SA-380

015-E01A-0380

PROTECT AGAINST FALLING STONES AND DEBRIS

- Confirm that your machine is FOPS cab equipped before working in areas where the possibility of falling stones or debris exist.

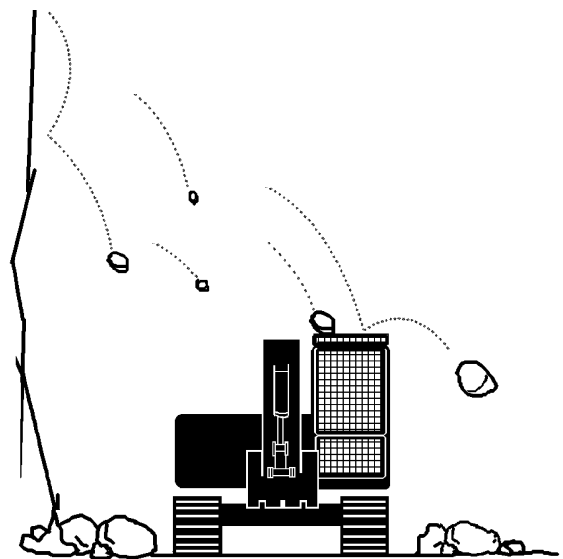

SA-490

015-E01A-0380

SAFETY

PROVIDE SIGNALS FOR JOBS INVOLVING MULTIPLE NUMBERS OF MACHINES

- For jobs involving multiple numbers of machines, provide signals commonly known by all personnel involved. Also, appoint a signal person to coordinate the job site. Make sure that all personnel obey the signal person's directions.



018-E01A-0481

SA-481

CONFIRM DIRECTION OF MACHINE TO BE DRIVEN

- Incorrect travel pedal/lever operation may result in serious injury death.
- Before driving the machine, confirm the position of the undercarriage in relation to the operator's position. If the travel motors are located in front of the cab, the machine will move in reverse when travel pedals/levers are operated to the front.

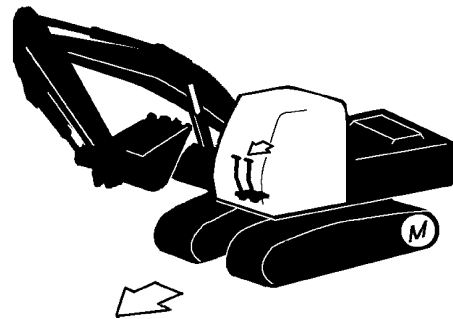

017-E01A-0491

SA-491

SAFETY

DRIVE MACHINE SAFELY

- Before driving the machine, always confirm that the travel levers/pedals direction corresponds to the direction you wish to drive.
- Be sure to detour around any obstructions.
- Avoid traveling over obstructions. Soil, fragments of rocks, and/or metal pieces may scatter around the machine. Don't allow personnel to stay around the machine while traveling.
- Driving on a slope may cause the machine to slip or overturn, possibly resulting in serious injury or death.
- When driving up or down a slope, keep the bucket facing the direction of travel, approximately 0.5 to 1.0 m (A) above the ground.
- If the machine starts to skid or becomes unstable, immediately lower the bucket to the ground and stop.

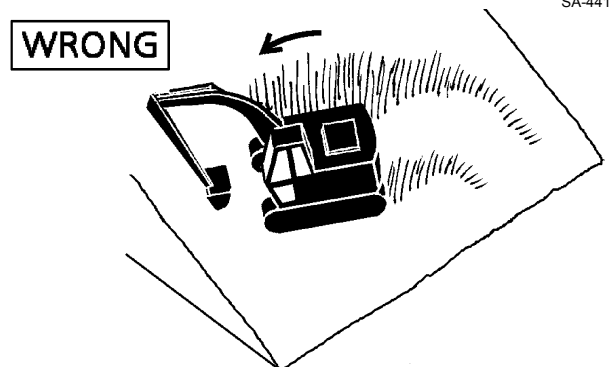
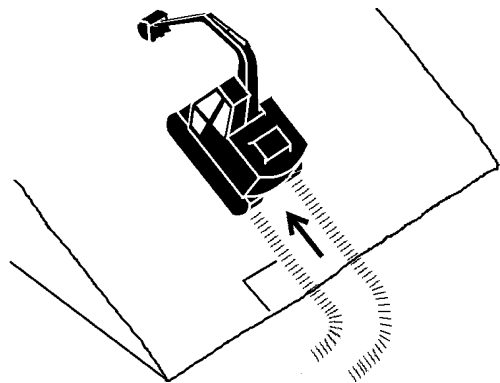
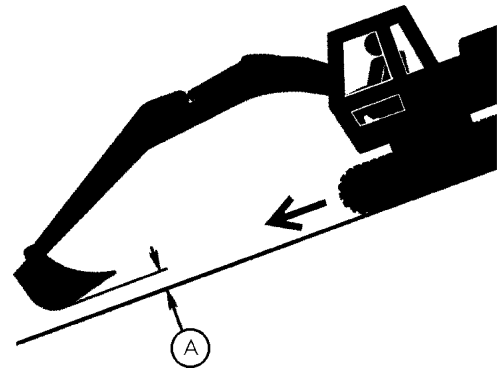
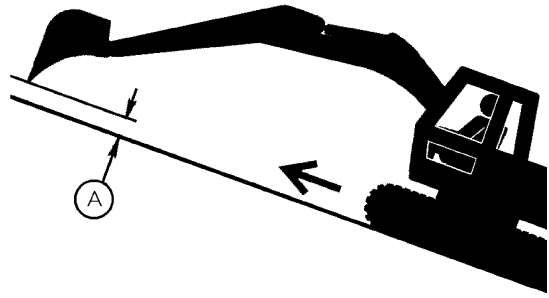

- Driving across the face of a slope or steering on a slope may cause the machine to skid or turnover. If the direction must be changed, move the machine to level ground, then, change the direction to ensure safe operation.

SAFETY

AVOID INJURY FROM ROLLAWAY ACCIDENTS

- Death or serious injury may result if you attempt to mount or stop a moving machine.

To avoid rollaways:

- Select level ground when possible to park machine.
- Do not park the machine on a grade.
- Lower the bucket and/or other work tools to the ground.
- Turn the auto-idle/acceleration switch and the H/P mode switch off.
- Run the engine at slow idle speed without load for 5 minutes to cool down the engine.
- Stop the engine and remove the key from the key switch.
- Pull the pilot control shut-off lever to LOCK position.
- Block both tracks and lower the bucket to the ground. Thrust the bucket teeth into the ground if you must park on a grade.
- Position the machine to prevent rolling.
- Park a reasonable distance from other machines.

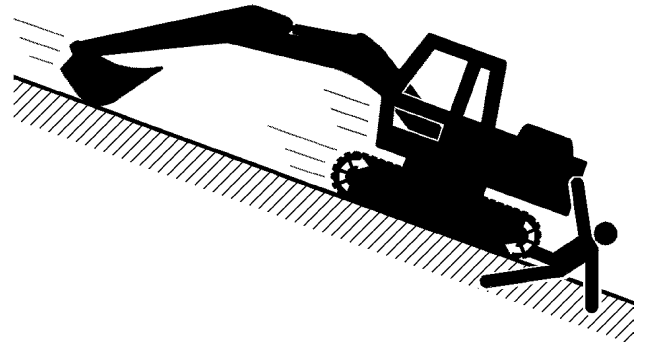

SA-391

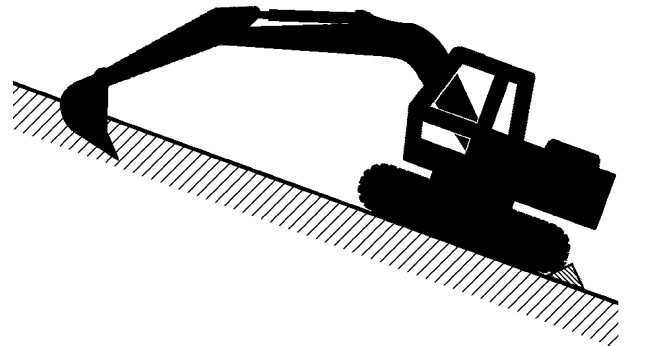

SA-392

020-E02A-0493



Suggest:

For more complete manuals. Please go to the home page.

<https://www.ebooklibonline.com>

If the above button click is invalid. Please download this document first, and then click the above link to download the complete manual.

Thank you so much for reading

SAFETY

AVOID INJURY FROM BACK-OVER AND SWING ACCIDENTS

- If any person is present near the machine when backing or swinging the upperstructure, the machine may hit or run over that person, resulting in serious injury or death.

To avoid back-over and swing accidents:

- Always look around **BEFORE YOU BACK UP AND SWING THE MACHINE**. BE SURE THAT ALL BY-STANDERS ARE CLEAR.
- Keep the travel alarm in working condition (if equipped).
ALWAYS BE ALERT FOR BYSTANDERS MOVING INTO THE WORK AREA. USE THE HORN OR OTHER SIGNAL TO WARN BYSTANDERS BEFORE MOVING MACHINE.
- USE A SIGNAL PERSON WHEN BACKING UP IF YOUR VIEW IS OBSTRUCTED. ALWAYS KEEP THE SIGNAL PERSON IN VIEW.
Use hand signals, which conform to your local regulations, when work conditions require a signal person.
- No machine motions shall be made unless signals are clearly understood by both signalman and operator.
- Learn the meanings of all flags, signs, and markings used on the job and confirm who has the responsibility for signaling.
- Keep windows, mirrors, and lights clean and in good condition.
- Dust, heavy rain, fog, etc., can reduce visibility. As visibility decreases, reduce speed and use proper lighting.
- Read and understand all operating instructions in the operator's manual.

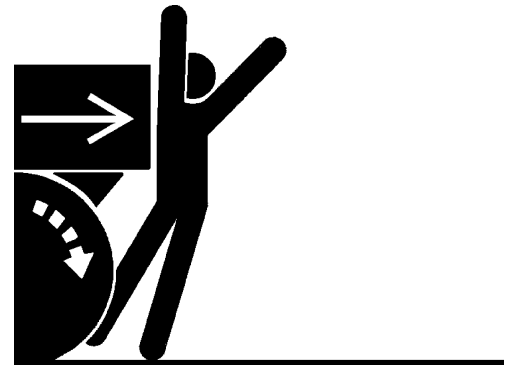

SA-383

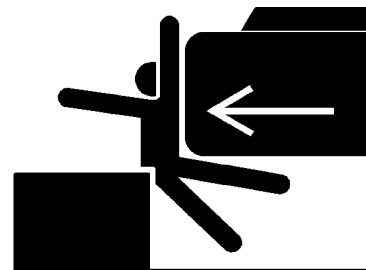

SA-384

021-E01A-0494

SAFETY

KEEP PERSON CLEAR FROM WORKING AREA

- A person may be hit severely by the swinging front attachment or counterweight and/or may be crushed against an other object, resulting in serious injury or death.
- Keep all persons clear from the area of operation and machine movement.
- Before operating the machine, set up barriers to the sides and rear area of the bucket swing radius to prevent anyone from entering the work area.

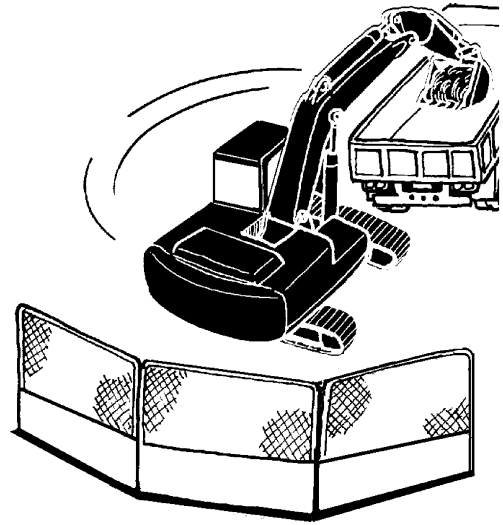

022-E01A-0386

SA-386

NEVER POSITION BUCKET OVER ANYONE

- Never lift, move, or swing bucket above anyone or a truck cab. Serious injury or machine damage may result due to bucket load spill or due to collision with the bucket.



023-E01A-0487

SA-487

AVOID UNDERCUTTING

- In order to retreat from the edge of an excavation if the footing should collapse, always position the undercarriage perpendicular to the edge of the excavation with the travel motors at the rear.
- If the footing starts to collapse and if retreat is not possible, do not panic. Often, the machine can be secured by lowering the front attachment, in such cases.

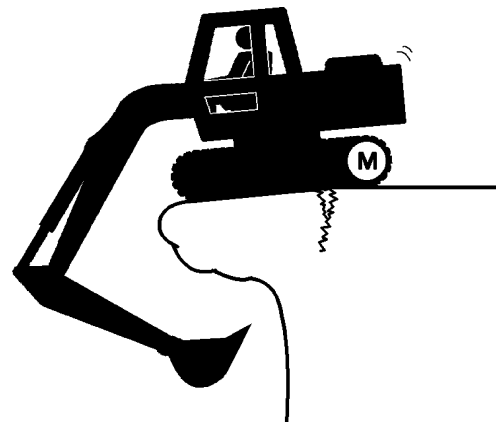

024-E01A-0488

SA-488

<https://www.ebooklibonline.com>

Hello dear friend!

Thank you very much for reading.

Enter the link into your browser.

The full manual is available for immediate download.

<https://www.ebooklibonline.com>