

PART NO. EMKCA-1-2

HITACHI

Operator's Manual

EX5600-6

Hydraulic Excavator

Serial No 002001 and up

INDEX

MACHINE NUMBERS

SAFETY

SAFETY SIGNS

COMPONENTS NAME

HANDLING STAIRWAY/EMERGENCY ESCAPE DEVICE

OPERATOR'S STATION

BREAK-IN

OPERATING ENGINE

DRIVING MACHINE

OPERATING MACHINE

MAINTENANCE

MAINTENANCE UNDER SPECIAL ENVIRONMENTAL CONDITIONS

STORAGE

TROUBLESHOOTING

SPECIFICATIONS

INDEX

CONTENTS

MACHINE NUMBERS

SAFETY

Recognize Safety Information	S-1
Understand Signal Words.....	S-1
Follow Safety Instructions.....	S-2
Prepare for Emergencies.....	S-3
Wear Protective Clothing.....	S-3
Protect Against Noise	S-3
Inspect Machine	S-4
General Precautions for Cab.....	S-4
Use Handholds and Steps	S-5
Adjust Operator's Seat.....	S-5
Ensure Safety Before Rising from or Leaving Operator's Seat	S-5
Fasten Your Seat Belt.....	S-6
Move and Operate Machine Safely.....	S-6
Handle Starting Aids Safely	S-6
Operate Only from Operator's Seat	S-7
Jump Starting	S-7
Precautions for Operations	S-8
Investigate Job Site Beforehand	S-9
Protect Against Falling Stones and Debris	S-10
Provide Signals for Jobs Involving Multiple Machines.....	S-10
Confirm Direction of Machine to be Driven	S-10
Drive Machine Safely.....	S-11
Avoid Injury from Rollaway Accidents.....	S-13
Avoid Injury from Back-Over and Swing Accidents	S-14
Keep Person Clear from Working Area.....	S-15
Never Position Bucket Over Anyone	S-15
Avoid Undercutting.....	S-15
Avoid Tipping.....	S-16
Never Undercut a High Bank.....	S-16
Dig with Caution.....	S-17
Operate with Caution	S-17
Avoid Power Lines.....	S-17
Precautions for Lightning	S-18
Object Handling	S-18
Protect Against Flying Debris	S-18
Park Machine Safely.....	S-19
Handle Fluids Safely – Avoid Fires.....	S-19
Practice Safe Maintenance.....	S-20
Warn Others of Service Work	S-21
Support Machine Properly.....	S-21
Stay Clear of Moving Parts	S-22
Prevent Parts from Flying	S-22
Store Attachments Safely	S-22
Prevent Burns.....	S-23
Replace Rubber Hoses Periodically.....	S-23
Avoid High-Pressure Fluids	S-24
Prevent Fires.....	S-25
Evacuating In Case of Fire.....	S-26
Beware of Exhaust Fumes.....	S-26
Precautions for Welding and Grinding	S-27
Avoid Heating Near Pressurized Fluid Lines	S-27

Avoid Applying Heat to Lines Containing Flammable Fluids.....	S-27
Precautions for Handling Accumulator.....	S-28
Remove Paint Before Welding or Heating	S-28
Beware of Asbestos and Silicon Dust and Other Contamination.....	S-29
Prevent Battery Explosions	S-30
Service Air Conditioning System Safely	S-30
Handle Chemical Products Safely.....	S-31
Dispose of Waste Properly.....	S-31
Precautions for Communication Terminal.....	S-31
SAFETY SIGNS.....	S-32

COMPONENTS NAME	1-1
------------------------------	------------

HANDLING STAIRWAY/EMERGENCY ESCAPE DEVICE

Using Stairway.....	1-2
Operating Stairway.....	1-2
Emergency Escape Device	1-5
Emergency Exit	1-6
Evacuating in Case of Fire.....	1-6

OPERATOR'S STATION

Cab Features.....	1-8
Monitor Display.....	1-9
Starting Check Screen	1-9
Meter Check Screen.....	1-10
Tachometer	1-11
Coolant Temperature Gauge	1-11
Hydraulic Oil Temperature Gauge	1-11
Fuel Gauge	1-11
Engine Oil Pressure Gauge	1-12
Engine Oil Temperature Gauge.....	1-12
Hour Meter	1-12
Warning Indicators	1-12
Alternator Indicator.....	1-12
Pump Transmission Oil Level Indicator	1-13
Engine Stop Indicator.....	1-13
Engine Oil Pressure Indicator.....	1-13
Coolant Overheat Indicator.....	1-13
Coolant Level Indicator.....	1-14
Engine Over Run Indicator	1-14
Fuel Temperature Indicator	1-14
Hydraulic Oil Level Indicator.....	1-14
Stop Valve Indicator	1-15
Auto-Lubrication Indicator.....	1-15
Fast-Filling Indicator	1-16
Emergency Engine Stop Indicator	1-16
Tension Indicator	1-16
Electric Lever Indicator	1-16
Caution Indicators	1-17
Exhaust Temperature Indicator.....	1-17
Engine Warning Indicator	1-17
Hydraulic Oil Overheat Indicator.....	1-17
Pump Contamination Indicator.....	1-17
Stairway Position Indicator.....	1-18
Air Cleaner Restriction Indicator	1-18

<https://www.ebooklibonline.com>

Hello dear friend!

Thank you very much for reading.

Enter the link into your browser.

The full manual is available for immediate download.

<https://www.ebooklibonline.com>

CONTENTS

Electrical Equipment Box Indicator	1-18	Starting Engine	3-8
Status Indicators.....	1-18	Starting Engine in Cold Weather.....	3-9
Auto-Idle Indicator	1-18	Check Instruments After Starting.....	3-10
Travel Mode Indicator	1-19	Using Booster Batteries	3-11
Prelub Indicator	1-19	Stopping Engine.....	3-13
Left Console.....	1-20	Emergency Engine Stop Switch	3-14
Warning Lamp.....	1-20	Engine Stop Switches	3-15
Caution Lamp.....	1-20	DRIVING MACHINE	
Key Pad	1-20	Drive Machine Carefully.....	4-1
Monitor Contrast Switch	1-20	Steering Machine Using Pedals.....	4-2
Wiper Switch.....	1-21	Steering Machine Using Levers.....	4-3
Washer Switch.....	1-21	Travel Mode Switch	4-4
Wiper Delay Selector Switch	1-21	Travel Alarm.....	4-5
Air Conditioners	1-22	Operating on Soft Ground	4-6
Designations and Functions of Controls.....	1-23	Raise One Track Using Boom and Arm	4-6
Cooling	1-25	Towing Machine a Short Distance.....	4-7
Heating	1-25	Operating in Ground Condition.....	4-8
Dehumidifying and Heating	1-25	Parking Machine on Slopes	4-9
Defrosting	1-26	Parking Machine.....	4-9
Blower Operation without Cooling		OPERATING MACHINE	
or Heating	1-26	Control Lever (ISO Pattern Backhoe)	5-1
Ventilation Cab	1-26	Control Lever (HITACHI Pattern Backhoe)	5-2
AM/FM Radio Operation.....	1-27	Control Lever (ISO Pattern Loading Shovel)	5-3
Digital Clock Setting Procedure	1-29	Control Lever (HITACHI Pattern	
Right Console.....	1-30	Loading Shovel)	5-4
Key Switch	1-30	Bucket Open-Close Pedals (Loading Shovel)	5-5
Emergency Engine Stop Switch.....	1-31	Pilot Control Shut-Off Lever	5-6
Engine Start Switch	1-31	Engine Speed Control.....	5-7
Engine Stop Switch	1-31	Auto-Idle.....	5-8
Engine Speed Control Dial.....	1-32	Warming-Up Operation	5-9
Work Light Switch.....	1-33	Warming-Up Cylinders and Motors	5-10
Dome Light Switch.....	1-34	Operate Machine Safely.....	5-11
Maintenance Light Switch.....	1-35	Operating Backhoe.....	5-12
Entrance Light Switch	1-36	Grading Operation.....	5-12
Travel Mode Switch	1-37	Avoid Abusive Operation	5-13
Auto-Idle Switch.....	1-37	Operating Tips	5-14
Buzzer Stop Switch.....	1-38	Avoid Side Load the Bucket.....	5-14
Fast-Filling System	1-39	Loading Shovel Operation	5-15
Rear Console	1-40	Prohibited Operation.....	5-15
Horn Switch	1-41	Object Handling	5-18
Adjusting Seat	1-42	Overnight Storage Instructions.....	5-19
Installation and Adjustment of Mirrors and Cameras		MAINTENANCE	
(Optional).....	1-45	Correct Maintenance and Inspection Procedures.....	7-1
Camera Monitor (Optional).....	1-46	Check Hour Meter Regularly	7-2
Seat Belt.....	1-47	Use Correct Fuels and Lubricants	7-2
Cab Door Release Button	1-48	Prepare Machine for Maintenance.....	7-3
Opening Cab Left Window.....	1-48	Open Access Doors for Service.....	7-4
BREAK-IN		Inspection/Maintenance Lights	7-5
Observe Machine Closely	2-1	Use a Chain to Prevent Falling Accidents	7-6
Every 10 Hours or Each Shift	2-1	Electric Pump.....	7-7
After the First 50 Hours	2-2	Construction Outline	7-9
OPERATING ENGINE		Hydraulic System.....	7-11
Inspect Machine Daily Before Starting	3-1	Periodic Replacement of Parts.....	7-16
Before Turning Power ON	3-2	Periodic Replacement of Rubber Hoses.....	7-17
Turning Power ON.....	3-3	Maintenance Interval Guide.....	7-24

CONTENTS

A. Greasing	7-28	Check Compressor Belt Tension	7-106
Backhoe Front Joint Pins	7-29	Clean Condenser Core	7-107
Loading Shovel Front Joint Pins	7-32	Check Tightening Torque	7-108
Swing Bearing	7-35	Seasonal Maintenance	7-109
Swing Internal Gear	7-36	I. Electrical System	7-110
Center Joint	7-37	Batteries	7-111
Operating Lubricator	7-38	Replacing Fuses	7-116
B. Engine	7-40	Check Power Source Terminal	7-120
Check Engine Oil Level in Engine Oil Pan	7-41	Check High Current Fuse	7-121
Check LED Monitor Signal (on Reserve Tank)	7-42	Check Electrical Cables and	
Change Engine Oil in Engine Oil Pan	7-43	Wire Harnesses for Short Circuits	7-122
Replace Engine Oil Filters	7-43	Check Emergency Engine Stop Switch	7-124
C. Transmission	7-47	J. Miscellaneous	7-125
Pump Transmission	7-48	Check Bucket Teeth	7-126
Swing Reduction Gear	7-51	Inspect Emergency Escape Device	
Travel Reduction Gear	7-53	and Hanger	7-129
D. Hydraulic System	7-55	Auto-Lubrication System	7-130
Inspection and Maintenance		Check and Replace Seat Belt	7-134
of Hydraulic Equipment	7-56	Check Windshield Washer Fluid Level	7-134
Check Hydraulic Oil Level	7-58	Clean Air Horn Compressor Filter	7-135
Drain Hydraulic Oil Tank Sump	7-60	Check Track Sag	7-136
Replace Full-Flow Filter and Drain Filter Element	7-61	Check Accumulator	7-138
Replace Bypass Filter Element	7-63	Clean Side Frame Area	7-138
Replace Pilot Oil Filter	7-65	Check Tightening Torque of Bolts	
Change Hydraulic Oil	7-67	and Nuts	7-139
Replace Suction Filter	7-70	MAINTENANCE UNDER SPECIAL	
Replace High-Pressure Filter Element	7-71	ENVIRONMENTAL CONDITIONS	
Clean Oil Cooler Core	7-73	Maintenance Under Special	
Check Hoses and Lines	7-74	Environmental Conditions	9-1
Service Recommendations for		STORAGE	
Hydraulic Fittings	7-77	Storing Machine	10-1
E. Fuel System	7-80	Removing Machine from Storage	10-2
Drain Fuel Tank Sump	7-82	Transporting Machine	10-2
Drain Fuel Filter Sediment	7-82	TROUBLESHOOTING	
Replace Fuel Filter Element	7-83	CUMMINS Fault Code Lamp and	
Replace Fuel Filter	7-84	Diagnostic Switches	11-1
Check Fuel Hoses	7-85	Engine	11-2
Clean Fuel Cooler Core	7-87	Electrical System	11-6
Clean Tank Breather	7-87	Mode Selection	11-8
F. Air Cleaner	7-88	Hydraulic System	11-9
Clean the Air Cleaner Outer Element	7-88	Auto-Idle	11-11
Replace the Air Cleaner Outer		SPECIFICATIONS	
and Inner Elements	7-88	Specifications	12-1
G. Cooling System	7-90	Working Range (Backhoe)	12-2
Check Coolant Level	7-90	Working Range (Loading Shovel)	12-3
Check DCA4 Concentration in Coolant	7-92	INDEX	14-1
Replace Coolant Filter	7-100		
Change Coolant	7-101		
Clean Radiator, After Cooler Interior	7-101		
Clean Radiator, After Cooler Core	7-102		
Check Fan Belt for Wear	7-102		
Check Radiator Stay for Looseness	7-102		
H. Air Conditioner	7-103		
Recirculation Air Filter	7-103		
Ventilation Air Filter	7-104		
Check Refrigerant Quantity	7-105		

MACHINE NUMBERS

The manufacturing Nos. explained in this group is the individual number (serial No.) given to each machine and main components. These numbers are requested when inquiring any information on the machine and/or components. Fill these serial Nos. in the blank spaces in this group to immediately make them available upon request.

MACHINE TYPE AND SERIAL NUMBER

MODEL/TYPE: _____

PRODUCT IDENTIFICATION NUMBER: _____

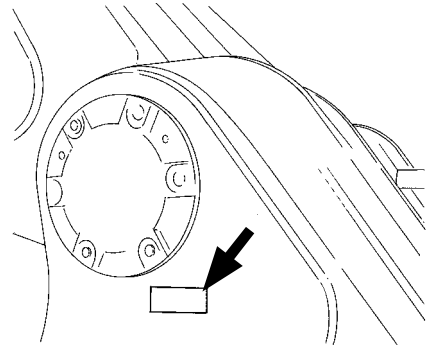

M118-07-095

PRODUCT IDENTIFICATION NUMBER

PRODUCT IDENTIFICATION NUMBER: _____

 **NOTE:** _____ Marks to indicate the start and end of the PIN
HCMKCA90E00002001
PRODUCT IDENTIFICATION NUMBER (PIN)

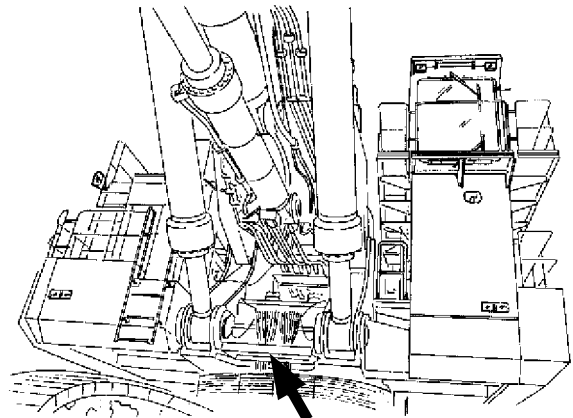

M118-01-011

ENGINE TYPE AND SERIAL NUMBER

TYPE: _____

MFG. NO.(LEFT): _____

MFG. NO.(RIGHT): _____

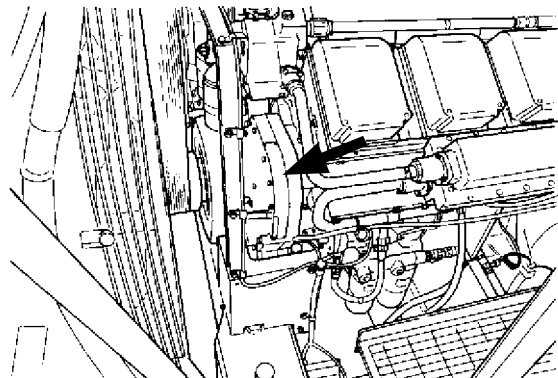

M117-07-092

MACHINE NUMBERS

TRAVEL MOTOR TYPE AND SERIAL NUMBER

TYPE: _____
MFG. NO.(LEFT FRONT): _____
MFG. NO.(LEFT REAR): _____
MFG. NO.(RIGHT FRONT): _____
MFG. NO.(RIGHT REAR): _____

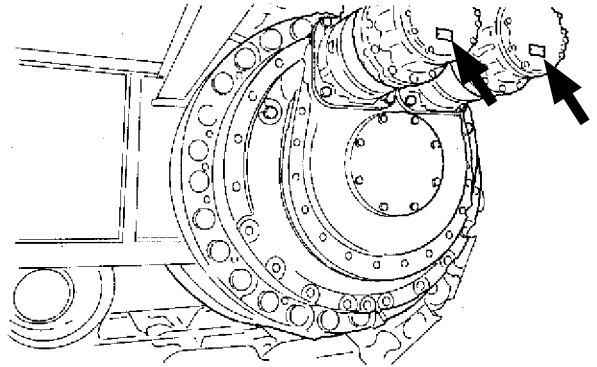

M118-07-029

CONTROL VALVE TYPE AND SERIAL NUMBER

TYPE: _____
MFG.NO.: (1) _____
MFG.NO.: (2) _____
MFG.NO.: (3) _____
MFG.NO.: (4) _____
MFG.NO.: (5) _____
MFG.NO.: (6) _____

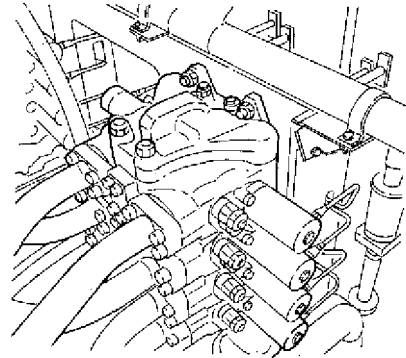

M118-07-045

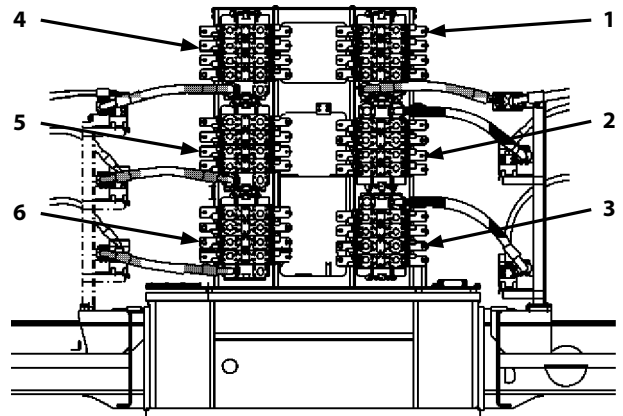

M118-07-084

MACHINE NUMBERS

SWING MOTOR TYPE AND SERIAL NUMBER

TYPE: _____
MFG. NO.(FRONT LEFT) : _____
MFG. NO.(FRONT RIGHT): _____
MFG. NO.(REAR LEFT): _____
MFG. NO.(REAR RIGHT): _____

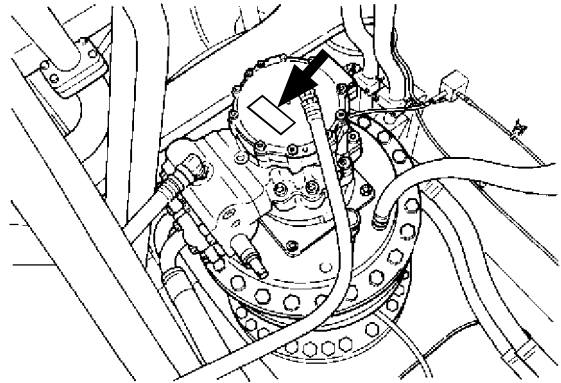

M117-07-082

HYDRAULIC PUMP TYPE AND SERIAL NUMBER

TYPE: _____
MFG. NO. _____

R 1	L 7
2	8
3	9
4	10
5	11
6	12

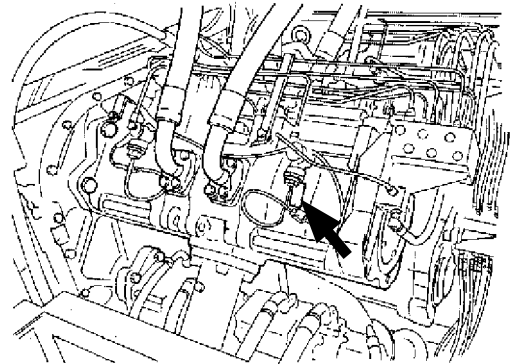

M118-07-044

FRONT TYPE AND SERIAL NUMBER (BACKHOE BOOM)

TYPE: _____
MFG. NO.: _____

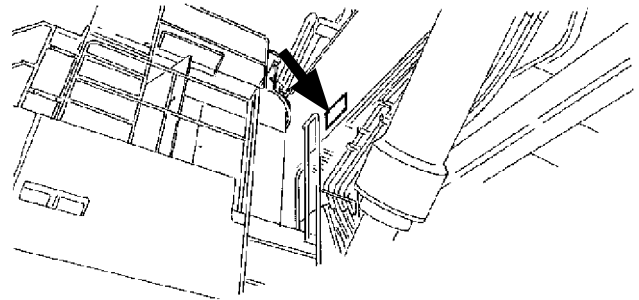

M118-07-101

FRONT TYPE AND SERIAL NUMBER (BACKHOE ARM)

TYPE: _____
MFG. NO.: _____

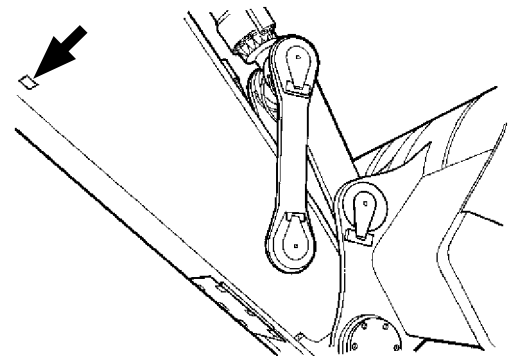

M118-07-128

MACHINE NUMBERS

BUCKET TYPE AND SERIAL NUMBER (BACKHOE)

TYPE: _____

MFG. NO.: _____

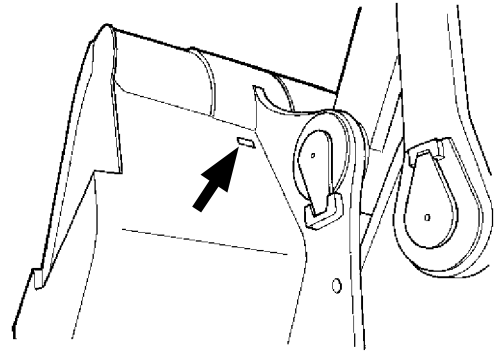

M118-07-129

FRONT TYPE AND SERIAL NUMBER (LOADING SHOVEL)

TYPE: _____

MFG. NO.: _____

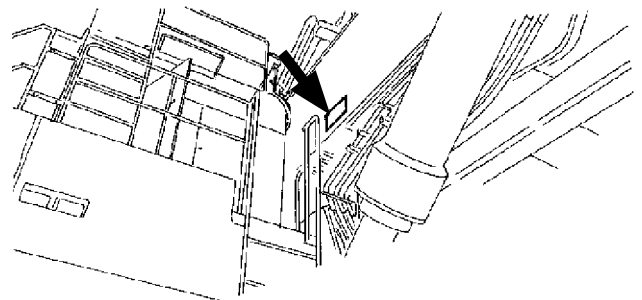

M118-07-101

BUCKET TYPE AND SERIAL NUMBER (LOADING SHOVEL)

TYPE: _____

MFG. NO.: _____

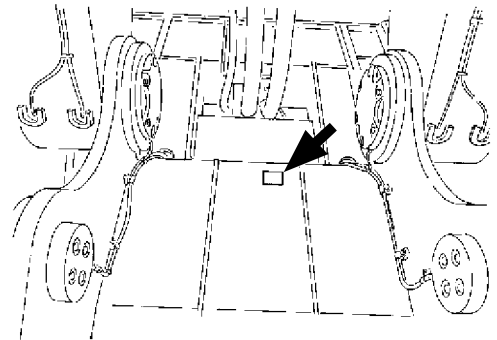

M118-07-100

SAFETY

RECOGNIZE SAFETY INFORMATION

- These are the **SAFETY ALERT SYMBOLS**.
 - When you see these symbols on your machine or in this manual, be alert to the potential for personal injury.
 - Follow recommended precautions and safe operating practices.



SA-688

UNDERSTAND SIGNAL WORDS

- On machine safety signs, signal words designating the degree or level of hazard - **DANGER**, **WARNING**, or **CAUTION** - are used with the safety alert symbol.
 - **DANGER** indicates an imminently hazardous situation which, if not avoided, will result in death or serious injury.
 - **WARNING** indicates a potentially hazardous situation which, if not avoided, could result in death or serious injury.
 - **CAUTION** indicates a potentially hazardous situation which, if not avoided, may result in minor or moderate injury.
 - **DANGER or WARNING safety signs** are located near specific hazards. General precautions are listed on **CAUTION safety signs**.
 - Some safety signs do not use any of the designated signal words above after the safety alert symbol are occasionally used on this machine.
- To avoid confusing machine protection with personal safety messages, a signal word **IMPORTANT** indicates a situation which, if not avoided, could result in damage to the machine.
-  **NOTE** indicates an additional explanation for an element of information.



IMPORTANT



SA-1223

SAFETY

FOLLOW SAFETY INSTRUCTIONS

- Carefully read and follow all safety signs on the machine and all safety messages in this manual.
- Safety signs should be installed, maintained and replaced when necessary.
 - If a safety sign or this manual is damaged or missing, order a replacement from your authorized dealer in the same way you order other replacement parts (be sure to state machine model and serial number when ordering).
- Learn how to operate the machine and its controls correctly and safely.
- Allow only trained, qualified, authorized personnel to operate the machine.
- Keep your machine in proper working condition.
 - Unauthorized modifications of the machine may impair its function and/or safety and affect machine life.
 - Do not modify any machine parts without authorization. Failure to do so may deteriorate the part safety, function, and/or service life. In addition, personal accident, machine trouble, and/or damage to material caused by unauthorized modifications will void Hitachi Warranty Policy.
 - Do not use attachments and/or optional parts or equipment not authorized by Hitachi. Failure to do so may deteriorate the safety, function, and/or service life of the machine. In addition, personal accident, machine trouble, and/or damage to material caused by using unauthorized attachments and/or optional parts or equipment will void Hitachi Warranty Policy.
- The safety messages in this SAFETY chapter are intended to illustrate basic safety procedures of machines. However it is impossible for these safety messages to cover every hazardous situation you may encounter. If you have any questions, you should first consult your supervisor and/or your authorized dealer before operating or performing maintenance work on the machine.

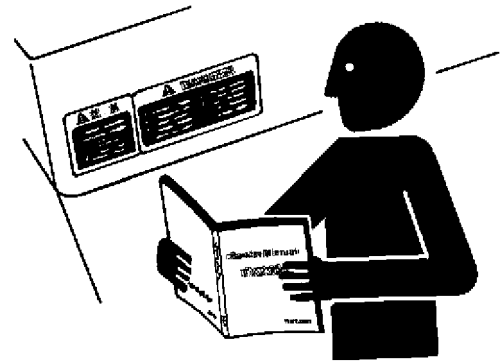

SA-003

SAFETY

PREPARE FOR EMERGENCIES

- Be prepared if a fire starts or if an accident occurs.
 - Keep a first aid kit and fire extinguisher on hand.
 - Thoroughly read and understand the label attached on the fire extinguisher to use it properly.
 - To ensure that a fire extinguisher can be always used when necessary, check and service the fire extinguisher at the recommended intervals as specified in the fire extinguisher manual.
 - Establish emergency procedure guidelines to cope with fires and accidents.
 - Keep emergency numbers for doctors, ambulance service, hospital, and fire department posted near your telephone.

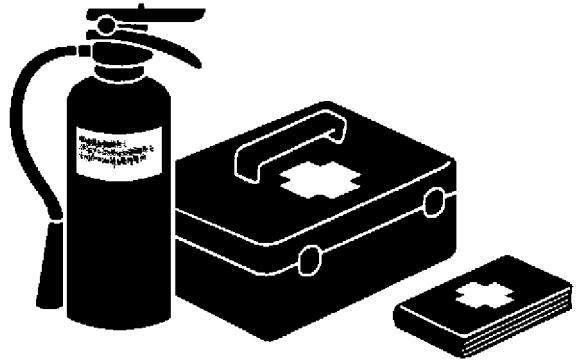

SA-437

WEAR PROTECTIVE CLOTHING

- Wear close fitting clothing and safety equipment appropriate to the job.

You may need:

- A hard hat
- Safety shoes
- Safety glasses, goggles, or face shield
- Heavy gloves
- Hearing protection
- Reflective clothing
- Wet weather gear
- Respirator or filter mask.

Be sure to wear the correct equipment and clothing for the job. Do not take any chances.

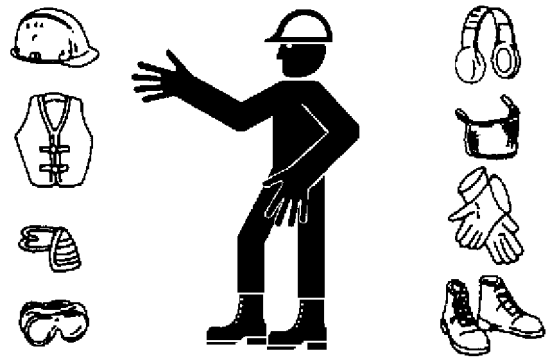

SA-438

- Avoid wearing loose clothing, jewelry, or other items that can catch on control levers or other parts of the machine.
- Operating equipment safely requires the full attention of the operator. Do not wear radio or music headphones while operating the machine.

PROTECT AGAINST NOISE

- Prolonged exposure to loud noise can cause impairment or loss of hearing.
 - Wear a suitable hearing protective device such as earmuffs or earplugs to protect against objectionable or uncomfortably loud noises.



SA-434

SAFETY

INSPECT MACHINE

- Inspect your machine carefully each day or shift by walking around it before you start it to avoid personal injury.
- In the walk-around inspection, be sure to cover all points described in the “MAINTENANCE” chapter in the operator’s manual.



SA-435

GENERAL PRECAUTIONS FOR CAB

- Before entering the cab, thoroughly remove all dirt and/or oil such as mud, grease, soil or stones that may mess up the cab from the soles of your work boots. If any controls such as a pedal is operated while with dirt and/or oil on the soles of the operator’s work boots, the operator’s foot may slip off the pedal, possibly resulting in a personal accident.
- Do not mess up around the operator’s seat with parts, tools, soil, stones, obstacles that may fold up or turn over, cans or lunch box. The levers or pedals become inoperable if obstacle jams in operation stroke of the travel levers/pedals, pilot control shut-off lever or control levers, which may result in serious injury or death.
- Do not leave parts and/or tools lying around the operator’s seat. Store them in their specified locations.
- Avoid storing transparent bottles in the cab. Do not attach any transparent type window decorations on the windowpanes as they may focus sunlight, possibly starting a fire.
- Refrain from listening to the radio, or using music headphones or mobile telephones in the cab while operating the machine.
- Keep all flammable objects and/or explosives away from the machine.
- After using the ashtray, always cover it to extinguish the match and/or tobacco.
- Do not leave cigarette lighters in the cab. When the temperature in the cab increases, the lighter may explode.
- Use proper floor mat dedicated to the machine. If another floor mat is used, it may be displaced and contact with the travel pedals or bucket open-close pedals during operation, resulting in serious injury or death.

SAFETY

USE HANDHOLDS AND STEPS

- Falling is one of the major causes of personal injury.
 - When you get on and off the machine, always face the machine and maintain a three-point contact with the steps and handrails.
 - Do not use any controls as handholds.
 - Never jump on or off the machine. Never mount or dismount a moving machine.
 - Be careful of slippery conditions on platforms, steps, and handrails when leaving the machine.
 - Never get on and off the machine with tools in your hand.

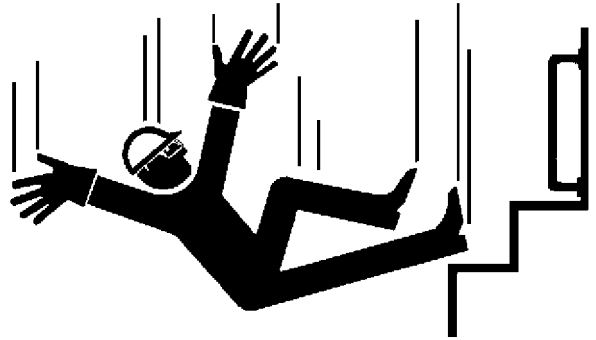

SA-439

ADJUST OPERATOR'S SEAT

- A poorly adjusted seat for either the operator or the work at hand may quickly fatigue the operator leading to misoperations.
 - The seat should be adjusted whenever changing the operator for the machine.
 - The operator should be able to fully depress the pedals and to correctly operate the control levers with his back against the seat back.
 - If not, move the seat forward or backward, and check again.
 - Adjust the rear view mirror position so that the best rear visibility is obtained from the operator's seat. If the mirror is broken, immediately replace it with a new one.



SA-378

ENSURE SAFETY BEFORE RISING FROM OR LEAVING OPERATOR'S SEAT

- Before rising from the operator's seat to open/close either side window or to adjust the seat position, be sure to first lower the front attachment to the ground and then move the pilot control shut-off lever to the LOCK position. Failure to do so may allow the machine to unexpectedly move when a body part unintentionally comes in contact with a control lever, possibly resulting in serious personal injury or death.
- Before leaving the machine, be sure to first lower the front attachment to the ground and then move the pilot control shut-off lever to the LOCK position. Press and hold the engine stop switches until stopping the engines completely. Remove the key from the key switch.
- Before leaving the machine, close all windows, doors, and access covers and lock them up.

SAFETY

FASTEN YOUR SEAT BELT

- If the machine should overturn, the operator may become injured and/or thrown from the cab. Additionally the operator may be crushed by the overturning machine, resulting in serious injury or death.
- Prior to operating the machine, thoroughly examine webbing, buckle and attaching hardware. If any item is damaged or worn, replace the seat belt or component before operating the machine.
- Be sure to remain seated with the seat belt securely fastened at all times when the machine is in operation to minimize the chance of injury from an accident.
- We recommend that the seat belt is replaced every three years regardless of its apparent condition.
- Seat belt is also provided on the trainer's seat. Be sure the rider on the trainer's seat properly fastens seat belt before operating the machine.

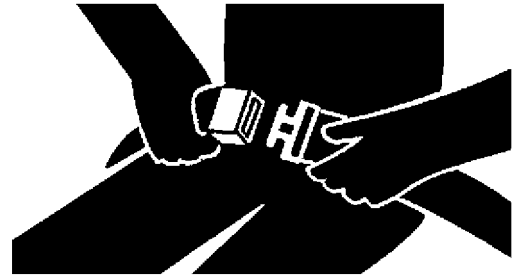

SA-237

MOVE AND OPERATE MACHINE SAFELY

- Bystanders can be run over.
 - Take extra care not to run over bystanders. Confirm the location of bystanders before moving, swinging, or operating the machine.
 - Always keep the travel alarm and horn in working condition (if equipped). It warns people when the machine starts to move.
 - Use a signal person when moving, swinging, or operating the machine in congested areas. Coordinate hand signals before starting the machine.
 - Use appropriate illumination. Check that all lights are operable before operating the machine. If any faulty illumination is present, immediately repair it.
 - Ensure the cab door, windows, doors and covers are securely locked.
 - Check the mirrors and the monitors in the CAB for problems. If there are, replace the problem parts or clean the mirrors, cameras and monitors.
Refer to Camera Monitor section on the cleaning of the camera and monitor.

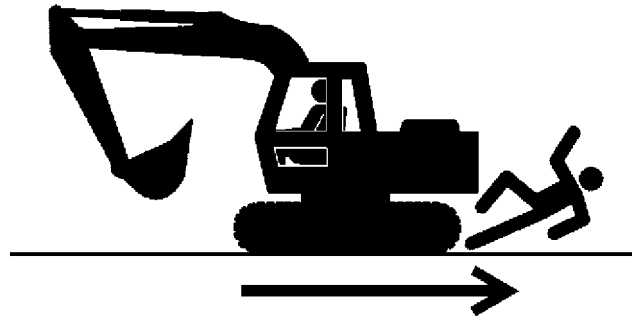

SA-426

HANDLE STARTING AIDS SAFELY

Starting fluid:

- Starting fluid is highly flammable.
 - Keep all sparks and flame away when using it.
 - Keep starting fluid well away from batteries and cables.
 - Remove container from machine if engine does not need starting fluid.
 - To prevent accidental discharge when storing a pressurized container, keep the cap on the container, and store it in a cool, well-protected location.
 - Do not incinerate or puncture a starting fluid container.



SA-293

SAFETY

OPERATE ONLY FROM OPERATOR'S SEAT

- Inappropriate engine starting procedures may cause the machine to runaway, possibly resulting in serious injury or death.
- Start the engines only from the operator's seat.
- Do not start engines by shorting across starter terminals.
- Before starting the engines, confirm that all control levers are in neutral.
- Before starting the engines, confirm the safety around the machine and sound the horn to alert bystanders.

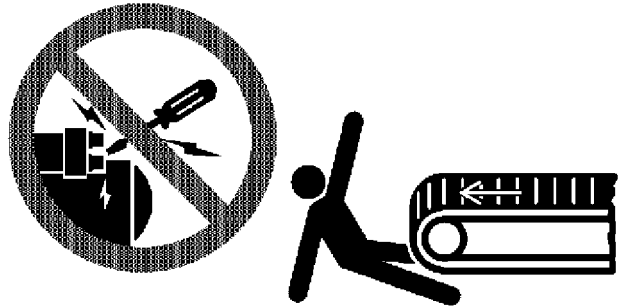

SA-444

JUMP STARTING

- Battery gas can explode, resulting in serious injury.
- If the engines must be jump started, be sure to follow the instructions shown in the "OPERATING ENGINE" chapter in the operator's manual.
- The operator must be in the operator's seat so that the machine will be under control when the engines start. Jump starting is a two-person operation.
- Never use a frozen battery.
- Failure to follow correct jump starting procedures could result in a battery explosion or a runaway machine.

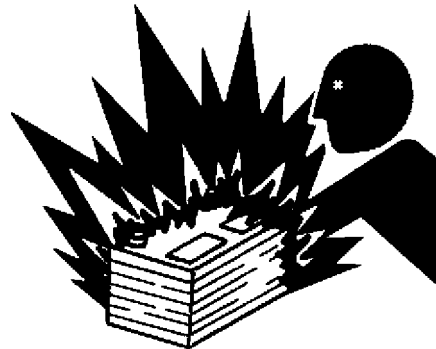

SA-032

SAFETY

PRECAUTIONS FOR OPERATIONS

- Investigate the worksite before starting operations.
 - Be sure to install an overhead cab guard when operating in a worksite which has a possibility of falling objects.
 - If operation on soft ground is required, sufficiently reinforce the ground beforehand.
 - Be sure to wear close fitting clothing and safety equipment appropriate for the job, such as a hard hat, etc. when operating the machine.
 - Clear all persons and obstacles from area of operation and machine movement.

Always beware of the surroundings while operating.

When working in a small area surrounded by obstacles, take care not to hit the upperstructure against obstacles.

- When loading onto trucks, bring the bucket over the truck beds from the rear side. Take care not to swing the bucket over the cab or over any person.

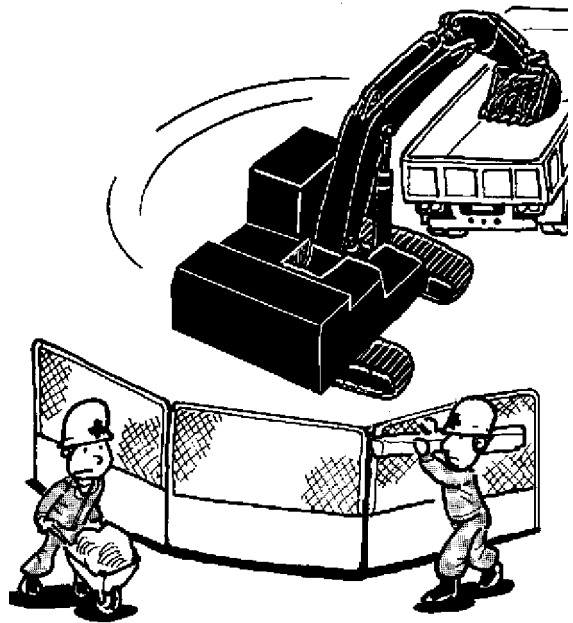

M117-05-006

SAFETY

INVESTIGATE JOB SITE BEFOREHAND

- When working at the edge of an excavation or on a road shoulder, the machine could tip over, possibly resulting in serious injury or death.
- Investigate the configuration and ground conditions of the job site beforehand to prevent the machine from falling and to prevent the ground, stockpiles, or banks from collapsing.
- Make a work plan. Use machines appropriate to the work and job site.
- Reinforce ground, edges, and road shoulders as necessary. Keep the machine well back from the edges of excavations and road shoulders.
- When working on an incline or on a road shoulder, employ a signal person as required.
- When the footing is weak, reinforce the ground before starting work.
- When working on frozen ground, be extremely alert. As ambient temperatures rise, footing becomes loose and slippery.
- Beware the possibility of fire when operating the machine near flammable objects such as dry grass.
- Make sure the worksite has sufficient strength to firmly support the machine.
When working close to an excavation or at road shoulders, operate the machine with the tracks positioned perpendicular to the cliff face with travel motors at the rear, so that the machine can more easily evacuate if the cliff face collapses.
- If working on the bottom of a cliff or a high bank is required, be sure to investigate the area first and confirm that no danger of the cliff or bank collapsing exists. If any possibility of cliff or bank collapsing exists, do not work on the area.
- Soft ground may collapse when operating the machine on it, possibly causing the machine to tip over. When working on a soft ground is required, be sure to reinforce the ground first using large pieces of steel plates strong and firm enough to easily support the machine.
- Note that there is always a possibility of machine tipping over when working on rough terrain or on slopes. Prevent machine tipping over from occurring. When operating on rough terrain or on slopes:
 - Reduce the engine speed.
 - Select slow travel speed mode.
 - Operate the machine slowly and be cautious with machine movements.

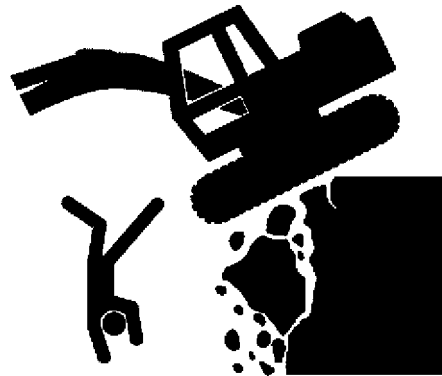

SA-380

SAFETY

PROTECT AGAINST FALLING STONES AND DEBRIS

- Confirm that your machine is FOPS cab equipped before working in areas where the possibility of falling stones or debris exist.

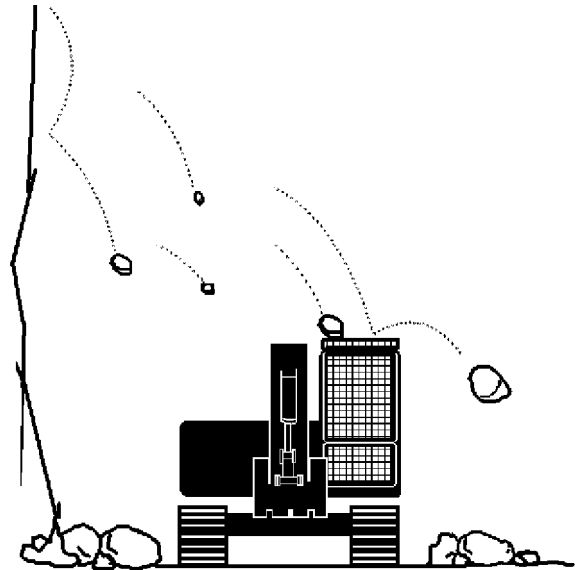

SA-490

PROVIDE SIGNALS FOR JOBS INVOLVING MULTIPLE MACHINES

- For jobs involving multiple machines, provide signals commonly known by all personnel involved. Also, appoint a signal person to coordinate the job site. Make sure that all personnel obey the signal person's directions.



SA-481

CONFIRM DIRECTION OF MACHINE TO BE DRIVEN

- Incorrect travel pedal/lever operation may result in serious injury death.
- Before driving the machine, confirm the position of the undercarriage in relation to the operator's position. If the travel motors are located in front of the cab, the machine will move in reverse when travel pedals/levers are operated to the front.

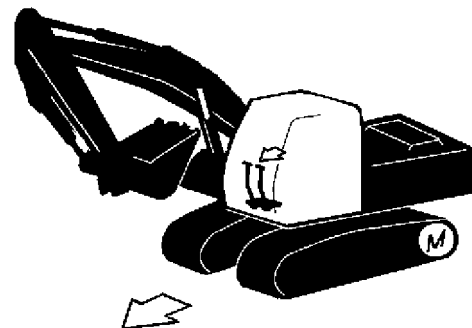

SA-491

SAFETY

DRIVE MACHINE SAFELY

- Before driving the machine, always confirm that the travel levers/pedals direction corresponds to the direction you wish to drive.
 - Be sure to detour around any obstructions.
 - Avoid traveling over obstructions. Soil, fragments of rocks, and/or metal pieces may scatter around the machine. Do not allow personnel to stay around the machine while traveling.
- Driving on a slope may cause the machine to slip or overturn, possibly resulting in serious injury or death.
 - Never attempt to ascend or descend 30 degrees or steeper slopes.
 - Be sure to fasten the seat belt.
 - When driving up or down a slope, keep the bucket facing the direction of travel, approximately 0.5 to 1.0 m (A) above the ground.
 - If the machine starts to skid or becomes unstable, immediately lower the bucket to the ground and stop.

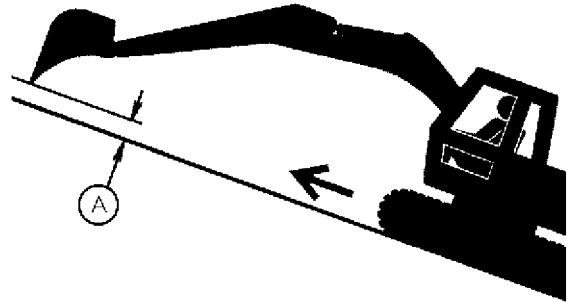

SA-387

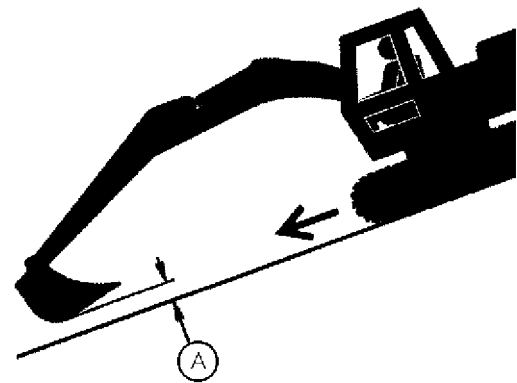

SA-388

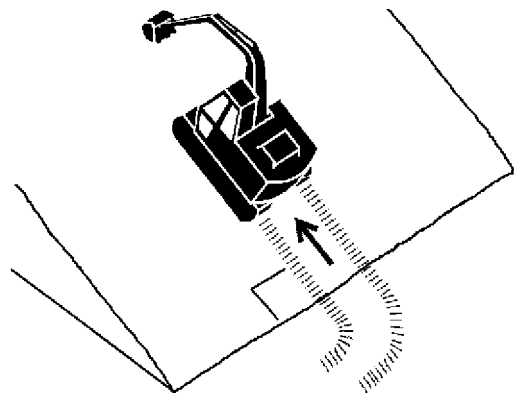

SA-441

- Driving across the face of a slope or steering on a slope may cause the machine to skid or turnover. If the direction must be changed, move the machine to level ground, then, change the direction to ensure safe operation.
- Avoid swinging the upperstructure on slopes. Never attempt to swing the upperstructure downhill. The machine may tip over. If swinging uphill is unavoidable, carefully operate the upperstructure and boom at slow speed.
- If the engines stall on a slope, immediately lower the bucket to the ground. Return the control levers to neutral. Then, restart the engines.

WRONG

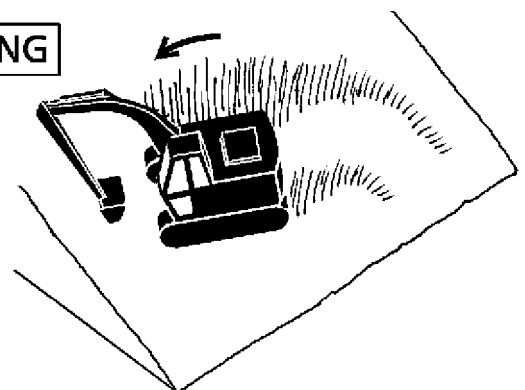

SA-589



Suggest:

For more complete manuals. Please go to the home page.

<https://www.ebooklibonline.com>

If the above button click is invalid. Please download this document first, and then click the above link to download the complete manual.

Thank you so much for reading

SAFETY

- Be sure to fully pull up the stairway before traveling.
- Be sure to thoroughly warm up the machine before ascending steep slopes. If hydraulic oil has not warmed up sufficiently, sufficient performance may not be obtained.
- Before descending a slope, turn the travel mode switch to the SLOW position on level ground. Do not operate the travel mode switch while descending a slope. The machine may slip, possibly causing safety accident.
- When descending a steep slope, avoid quick start or stop traveling in the FAST mode. Failure to do so may result in damage to the travel motors.
- Use a signal person when moving, swinging or operating the machine in congested areas. Coordinate hand signals before starting the machine.
- Before moving machine, determine which way to move travel pedals/levers for the direction you want to go. When the travel motors are in the rear, pushing down on the front of the travel pedals or pushing the levers forward moves the machine forward, towards the idlers.
- Select a travel route that is as flat as possible. Steer the machine as straight as possible, making small gradual changes in direction.
- When traveling on a level surface, position the front with boom (1) fully raised, and arm (2) fully retracted, as illustrated, in order to apply the load as evenly as possible to all of the lower rollers.
- Before traveling on them, check the strengths of bridges and road shoulders, and reinforce if necessary.
- Do not make contact with electric wires or bridges.
- When crossing a river, measure the depth of the river using the bucket, and cross slowly. Do not cross the river when the depth of the river is deeper than the upper edge of the upper rollers.
- When traveling on rough terrain, reduce engine speed. Select slow travel speed. Slower speed will reduce possible damage to the machine.
- Avoid operations that may damage the track and undercarriage components.
- During freezing weather, always clean snow and ice from track shoes to prevent the machine from slipping.

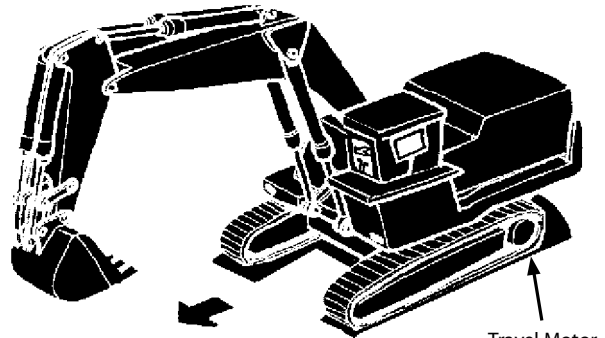

Travel Motor
M145-05-003

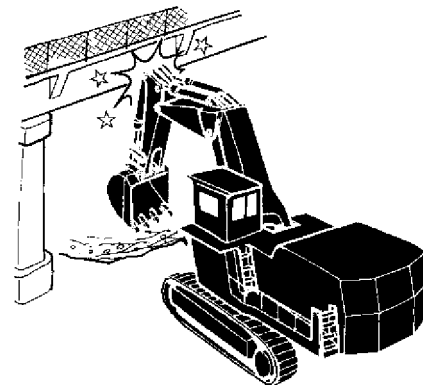

M145-05-004

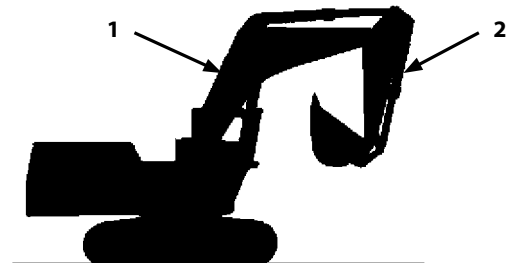

M145-05-027

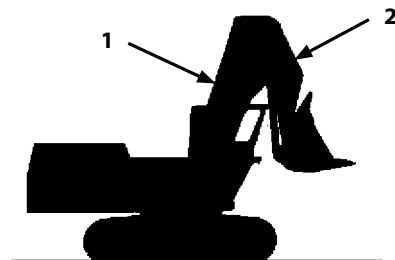

M145-05-022

SAFETY

AVOID INJURY FROM ROLLAWAY ACCIDENTS

- Death or serious injury may result if you attempt to mount or stop a moving machine.

To avoid rollaways:

1. Select level ground when possible to park the machine.
2. Do not park the machine on a grade.
3. Lower the bucket and/or other work tools to the ground.
4. Turn the auto-idle switch off.
5. Run the engines at slow idle speed without load for 5 minutes to cool down the engines.
6. Stop the engines and remove the key from the key switch.
7. Pull the pilot control shut-off lever to LOCK position.
8. Block both tracks and lower the bucket to the ground. Thrust the bucket teeth into the ground if you must park on a grade.
9. Position the machine to prevent rolling.
10. Park at a reasonable distance from other machines.

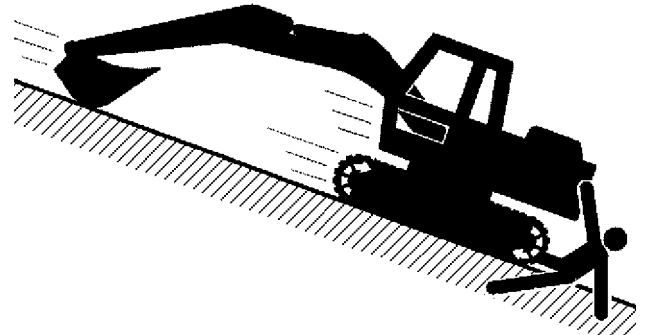

SA-391

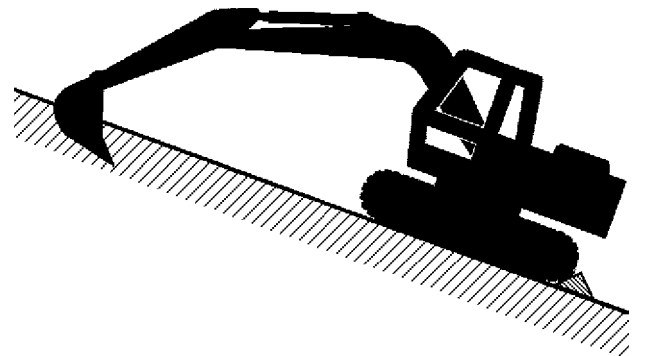

SA-392

<https://www.ebooklibonline.com>

Hello dear friend!

Thank you very much for reading.

Enter the link into your browser.

The full manual is available for immediate download.

<https://www.ebooklibonline.com>