

PART No. EM17F – EN 1 – 4

# **Operator's Manual**

# **EX1200-5**

# **Hydraulic Excavator**

Serial No. 001001 and up

**HITACHI**

# INDEX

MACHINE NUMBERS

SAFETY

SAFETY SIGNS

COMPONENTS NAME

GETTING ON/OFF THE MACHINE

OPERATOR'S STATION

BREAK-IN

OPERATING THE ENGINE

DRIVING THE MACHINE

OPERATING THE MACHINE

TRANSPORTING

MAINTENANCE

MAINTENANCE UNDER SPECIAL ENVIRONMENTAL CONDITIONS

STORAGE

TROUBLESHOOTING

SPECIFICATIONS

INDEX



**<https://www.ebooklibonline.com>**

Hello dear friend!

Thank you very much for reading.

Enter the link into your browser.

The full manual is available for immediate download.

**<https://www.ebooklibonline.com>**

# MACHINE NUMBERS

---

## SWING MOTOR TYPE AND SERIAL NUMBER

TYPE: \_\_\_\_\_

MFG. NO.: \_\_\_\_\_

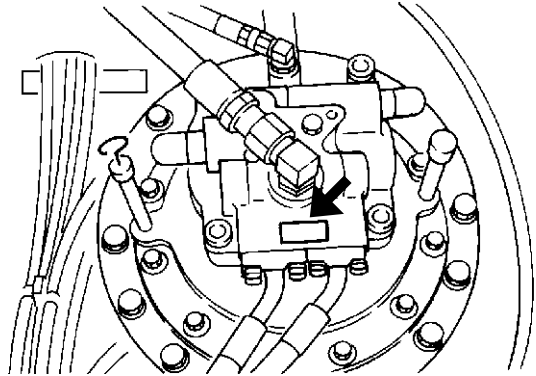

M142-12-003

## HYDRAULIC PUMP TYPE AND SERIAL NUMBER

TYPE: \_\_\_\_\_

MFG. NO.: \_\_\_\_\_

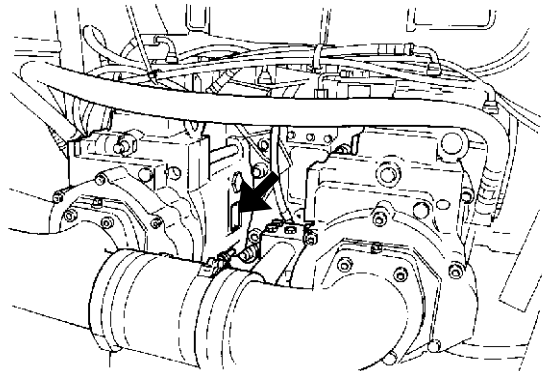

M142-12-004

---

# CONTENTS

## MACHINE NUMBERS

### SAFETY

Recognize Safety Information.....	S-1
Understand Signal Words.....	S-1
Follow Safety Instructions.....	S-2
Prepare for Emergencies.....	S-2
Wear Protective Clothing.....	S-3
Protect Against Noise.....	S-3
Inspect Machine.....	S-3
General Precautions for Cab.....	S-4
Use Handholds and Steps.....	S-5
Adjust the Operator's Seat.....	S-5
Fasten Your Seat Belt.....	S-6
Move and Operate Machine Safely.....	S-6
Operate Only from Operator's Seat.....	S-7
Jump Starting.....	S-7
Keep Riders Off Machine.....	S-7
Investigate Job Site Beforehand.....	S-8
Protect Against Falling Stones and Debris.....	S-8
Provide Signals for Jobs Involving Multiple Numbers of Machines.....	S-9
Confirm Direction of Machine to be Driven.....	S-9
Drive Machine Safely.....	S-10
Avoid Injury from Rollaway Accidents.....	S-11
Avoid Injury from Back-Over and Swing Accidents.....	S-12
Keep Person Clear from Working Area.....	S-13
Never Position Bucket Over Anyone.....	S-13
Avoid Undercutting.....	S-13
Avoid Tipping.....	S-14
Never Undercut a High Bank.....	S-14
Dig with Caution.....	S-15
Operate with Caution.....	S-15
Avoid Power Lines.....	S-15
Crane Operation is Prohibited.....	S-16
Protect Against Flying Debris.....	S-16
Park Machine Safely.....	S-17
Handle Fluids Safely – Avoid Fires.....	S-17
Practice Safe Maintenance.....	S-18
Warn Others of Service Work.....	S-19
Support Machine Properly.....	S-19
Stay Clear of Moving Parts.....	S-19
Prevent Parts from Flying.....	S-20
Store Attachments Safely.....	S-20
Prevent Burns.....	S-21
Replace Rubber Hoses Periodically.....	S-21
Avoid High-Pressure Fluids.....	S-22
Prevent Fires.....	S-23
Evacuating in Case of Fire.....	S-24
Beware of Exhaust Fumes.....	S-24
Precautions for Welding and Grinding.....	S-25
Avoid Heating Near Pressurized Fluid Lines.....	S-26
Avoid Applying Heat to Lines Containing Flammable Fluids.....	S-26
Remove Paint Before Welding or Heating.....	S-26

Prevent Battery Explosions.....	S-27
Service Air Conditioning System Safely.....	S-27
Handle Chemical Products Safely.....	S-28
Dispose of Waste Properly.....	S-28

### SAFETY SIGNS..... S-29

### COMPONENTS NAME..... 1-1

### GETTING ON/OFF THE MACHINE..... 1-2

### OPERATOR'S STATION

Emergency Rope (Elevated Cab).....	1-3
Cab Features.....	1-4
Monitor Panel.....	1-5
Coolant Temperature Gauger.....	1-5
Fuel Gauge.....	1-6
Fuel Level Indicator.....	1-6
Alternator Indicator.....	1-6
Engine Exhaust Temperature Indicator.....	1-6
Hydraulic Oil Level Indicator.....	1-7
Engine Warning Indicator.....	1-7
Coolant Level Indicator (Warning).....	1-7
Engine Stop Indicator.....	1-8
Auto-Lubrication Indicator.....	1-8
Engine Oil Level Indicator (Warning).....	1-8
Pump Transmission Oil Pressure Indicator (Warning).....	1-8
Engine Oil Pressure Indicator.....	1-9
Preheat Indicator.....	1-9
Download Indicator.....	1-9
Overheat Indicator.....	1-10
Air Filter Restriction Indicator.....	1-10
Lubrication Mode Indicator.....	1-10
Display.....	1-11
Auto-Idle Indicator.....	1-11
Quick Idle Indicator.....	1-11
Switch Panel 1.....	1-12
Display Selection Switch.....	1-12
Hour Meter.....	1-12
Trip Meter 1 And Trip Meter 2.....	1-13
User's Mode.....	1-13
Set Switch.....	1-14
Lubrication Mode Switch.....	1-15
Switch Panel 2.....	1-16
Engine Control Dial.....	1-16
Auto-Idle Switch.....	1-17
Power Mode Switch.....	1-17
Travel Mode Switch.....	1-18
Work Light Switch.....	1-19
Wiper/Washer Switch.....	1-20
Right Console.....	1-21
Key Switch.....	1-21
ALU Timer Switch (Auto-Lubrication Timer Switch).....	1-21
Heavy Lift Switch.....	1-22

---

# CONTENTS

---

Boom Mode Switch.....	1-22
Auto Air Conditioner.....	1-23
Cab Heater Operation .....	1-27
Cooling Operation.....	1-27
Defroster Operation.....	1-28
Tips for Optimal Air Conditioner Usage.....	1-29
Left Console.....	1-31
Preheat Switch.....	1-31
Step Light Switch .....	1-32
AM/FM Radio Operation .....	1-33
Digital Clock Setting Procedure.....	1-34
Rear Console.....	1-35
Engine Diagnostic Switch .....	1-35
Buzzer and Buzzer Stop Switch.....	1-36
Travel Alarm Stop Switch (Optional) .....	1-36
Quick Idle Switch .....	1-37
Download Indicator .....	1-37
Horn Switch .....	1-37
Pilot Control Shut-Off Lever.....	1-38
Cab Light .....	1-38
Fuse Box (Left).....	1-39
Fuse Box (Right).....	1-39
Cab Door Release Lever .....	1-40
Opening Cab Door Window.....	1-40
Hazard Warning Lamp.....	1-40
Extinguisher --- If Equipped .....	1-40
Emergency Exit.....	1-41
Emergency Exit (Elevated Cab).....	1-42
Operator's Seat Adjustment .....	1-44
Seat Belt .....	1-46

## BREAK-IN

Observe Engine Operation Closely .....	2-1
Every 10 Hours or Daily.....	2-1
After the First 50 Hours .....	2-1

## OPERATING THE ENGINE

Inspect Machine Daily Before Starting.....	3-1
Before Starting Engine.....	3-2
Level Check.....	3-3
Starting the Engine .....	3-4
Starting in Cold Weather .....	3-5
Check Instruments After Starting .....	3-7
Using Booster Batteries.....	3-8
Stopping the Engine .....	3-10

## DRIVING THE MACHINE

Drive the Machine Carefully.....	4-1
Steering the Machine Using Pedals.....	4-2
Steering the Machine Using Levers.....	4-3
Travel Mode Switch .....	4-4
Travel Alarm (Optional) .....	4-4
Traveling .....	4-5
Operating on Soft Ground .....	4-6
Raise One Track Using Boom and Arm .....	4-6
Towing Machine a Short Distance.....	4-7

Operating in Water or Mud.....	4-8
Precautions for Traveling on Slopes .....	4-9
Parking the Machine on Slopes .....	4-10
Parking the Machine .....	4-10

## OPERATING THE MACHINE

Control Lever (ISO Pattern Backhoe) .....	5-1
Control Lever (ISO Pattern Loading Shovel) .....	5-2
Control Lever (HITACHI Pattern Backhoe) .....	5-3
Control Lever (HITACHI Pattern Loading Shovel) .....	5-4
Bucket Open-Close Pedals (Loading Shovel).....	5-5
Pilot Control Shut-Off Lever .....	5-6
Auto-Idle .....	5-8
Quick Idle .....	5-9
Engine Speed Control .....	5-10
Power Mode .....	5-11
E (Economy) Mode .....	5-12
P (Power) Mode .....	5-13
S/P (Super Power) Mode .....	5-14
Heavy Lift .....	5-15
Precautions for Operations .....	5-16
Operate the Machine Safely.....	5-17
Operating Backhoe .....	5-18
Grading Operation.....	5-18
Avoid Abusive Operation.....	5-19
Operating Tips.....	5-20
Select Correct Track Shoes .....	5-20
Loading Shovel Operation.....	5-21
Prohibited Operation .....	5-21
Crane Operation is Prohibited.....	5-24
Overnight Storage Instructions.....	5-25

## TRANSPORTING

Packing Dimensions and Weights for Transportation.....	6-1
---	-----

## MAINTENANCE

Correct Maintenance and Inspection Procedures .....	7-1
Check the Hour Meter Regularly.....	7-2
Use Correct Fuels and Lubricants .....	7-2
Prepare Machine for Maintenance .....	7-3
Hood and Access Covers.....	7-4
Use Electrical Outlet.....	7-4
Construction Outline.....	7-6
Hydraulic System .....	7-7
Loading Shovel.....	7-8
Backhoe .....	7-10
Electrical Circuit Diagram .....	7-11
Periodic Replacement of Parts .....	7-13
Maintenance Interval Guide .....	7-16
A. Greasing .....	7-19
Front Joint Pins .....	7-20
Swing Bearing .....	7-24
Swing Internal Gear .....	7-27

---

# CONTENTS

---

B. Engine .....	7-28
Engine Oil Level .....	7-30
Change Engine Oil .....	7-30
Replace Engine Oil Main Filters .....	7-30
Replace Engine Oil Bypass Filter .....	7-30
Check Injection Nozzle .....	7-32
Inspect Bolts and Nuts Outside Engine .....	7-32
Inspect and Adjust Valve Clearance .....	7-32
Check Fuel Injection Timing .....	7-32
Check Starter and Alternator .....	7-32
Check Turbocharger .....	7-32
C. Transmission .....	7-33
Pump Transmission .....	7-34
Swing Reduction Gear .....	7-37
Travel Reduction Gear .....	7-39
D. Hydraulic System .....	7-41
Inspection and Maintenance of Hydraulic Equipment .....	7-42
Check Hydraulic Oil Level .....	7-44
Drain Hydraulic Tank Sump .....	7-45
Change Hydraulic Oil .....	7-46
Suction Filter Cleaning .....	7-49
Replace Drain Filter Element .....	7-50
Replace Full-Flow Filter .....	7-52
Replace Pilot Oil Filter Element .....	7-54
Check Hoses and Lines .....	7-56
Service Recommendations for Hydraulic Fittings .....	7-59
E. Fuel System .....	7-62
Drain Fuel Tank Sump .....	7-64
Drain Water Separator Filter Sediment .....	7-65
Replace Water Separator Filter .....	7-66
Replace Fuel Filter .....	7-67
Check Fuel Hoses .....	7-69
F. Air Cleaner .....	7-71
Clean the Air Cleaner Outer Element .....	7-71
Replace the Air Cleaner Outer and Inner Elements .....	7-71
G. Cooling System .....	7-73
Check Coolant Level .....	7-75
Check Fan Belt for Wear .....	7-76
Change Coolant .....	7-77
Clean Radiator Core and Oil Cooler Core .....	7-79
Clean Inter Cooler Front Screen .....	7-79
H. Air Conditioner .....	7-80
Ventilation Air Filter .....	7-80
Recirculation Air Filter .....	7-81
Check Refrigerant Quantity .....	7-82
Check Compressor Belt Tension .....	7-83
Clean Condenser Core .....	7-83
Check Tightening Torque .....	7-84
Seasonal Maintenance .....	7-85
I. Electrical System .....	7-86
Replace Batteries .....	7-89
Replacing Fuses .....	7-90
J. Miscellaneous .....	7-95

Check Bucket Teeth .....	7-96
Change Bucket (Buckhoe) .....	7-101
Check and Replace Seat Belt .....	7-102
Check Windshield Washer Fluid Level .....	7-102
Check Track Sag .....	7-103
Auto-Lubrication System .....	7-104
Check Tightening Torque of Bolts and Nuts .....	7-108

## MAINTENANCE UNDER SPECIAL ENVIRONMENTAL CONDITIONS

Maintenance Under Special Environmental Conditions .....	9-1
---	-----

## STORAGE

Storing the Machine .....	10-1
Removing the Machine from Storage .....	10-2

## TROUBLESHOOTING

Engine .....	11-1
Electrical System .....	11-6
Mode Selection .....	11-8
Control Levers .....	11-9
Hydraulic System .....	11-9

## SPECIFICATIONS

Specifications .....	12-1
Working Range (Backhoe) .....	12-3
Working Range (BE Backhoe) .....	12-4
Working Range (Loading Shovel) .....	12-5
Backhoe Shoe Types and Applications .....	12-6

INDEX .....	14-1
-------------	------

---

# SAFETY

## RECOGNIZE SAFETY INFORMATION

- These are the **SAFETY ALERT SYMBOLS**.
  - When you see these symbols on your machine or in this manual, be alert to the potential for personal injury.
  - Follow recommended precautions and safe operating practices.

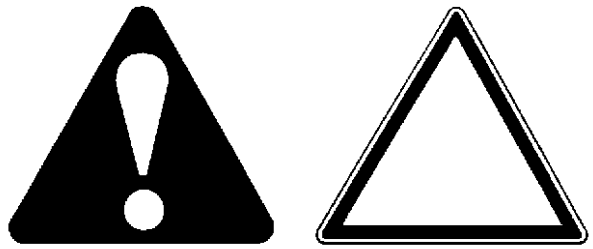

SA-688

001-E01A-0001

## UNDERSTAND SIGNAL WORDS

- On machine safety signs, signal words designating the degree or level of hazard - **DANGER**, **WARNING**, or **CAUTION** - are used with the safety alert symbol.
  - **DANGER** indicates an imminently hazardous situation which, if not avoided, will result in death or serious injury.
  - **WARNING** indicates a potentially hazardous situation which, if not avoided, could result in death or serious injury.
  - **CAUTION** indicates a potentially hazardous situation which, if not avoided, may result in minor or moderate injury.
  - **DANGER** or **WARNING** safety signs are located near specific hazards. General precautions are listed on **CAUTION** safety signs.
  - Some safety signs don't use any of the designated signal words above after the safety alert symbol are occasionally used on this machine.



**IMPORTANT**



SA-1223

- **CAUTION** also calls attention to safety messages in this manual.
- To avoid confusing machine protection with personal safety messages, a signal word **IMPORTANT** indicates a situation which, if not avoided, could result in damage to the machine.
-  **NOTE** indicates an additional explanation for an element of information.

002-E01A-1223

## SAFETY

### FOLLOW SAFETY INSTRUCTIONS

- Carefully read and follow all safety signs on the machine and all safety messages in this manual.
- Safety signs should be installed, maintained and replaced when necessary.
  - If a safety sign or this manual is damaged or missing, order a replacement from your authorized dealer in the same way you order other replacement parts (be sure to state machine model and serial number when ordering).
- Learn how to operate the machine and its controls correctly and safely.
- Allow only trained, qualified, authorized personnel to operate the machine.
- Keep your machine in proper working condition.
  - Unauthorized modifications of the machine may impair its function and/or safety and affect machine life.
- The safety messages in this SAFETY chapter are intended to illustrate basic safety procedures of machines. However it is impossible for these safety messages to cover every hazardous situation you may encounter. If you have any questions, you should first consult your supervisor and/or your authorized dealer before operating or performing maintenance work on the machine.

003-E01B-0003

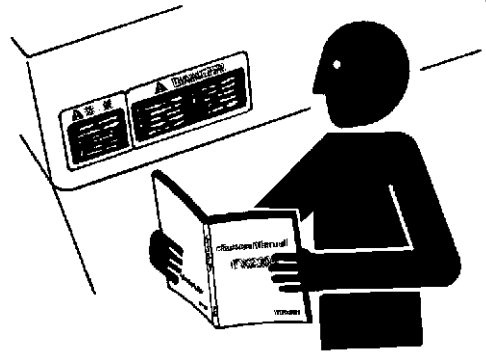

SA-003

### PREPARE FOR EMERGENCIES

- Be prepared if a fire starts or if an accident occurs.
  - Keep a first aid kit and fire extinguisher on hand.
  - Thoroughly read and understand the label attached on the fire extinguisher to use it properly.
  - To ensure that a fire-extinguisher can be always used when necessary, check and service the fire-extinguisher at the recommended intervals as specified in the fire-extinguisher manual.
- Establish emergency procedure guidelines to cope with fires and accidents.
- Keep emergency numbers for doctors, ambulance service, hospital, and fire department posted near your telephone.

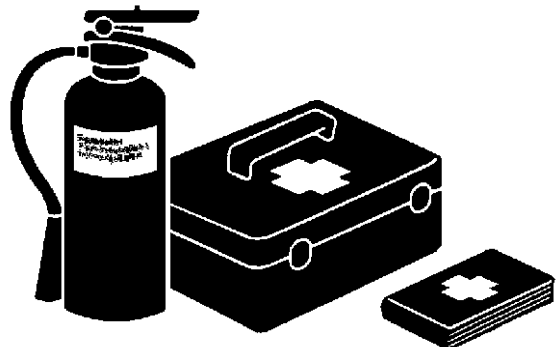

SA-437

004-E01A-0437

## SAFETY

---

### WEAR PROTECTIVE CLOTHING

- Wear close fitting clothing and safety equipment appropriate to the job.

You may need:

- A hard hat
- Safety shoes
- Safety glasses, goggles, or face shield
- Heavy gloves
- Hearing protection
- Reflective clothing
- Wet weather gear
- Respirator or filter mask.

Be sure to wear the correct equipment and clothing for the job. Do not take any chances.

- Avoid wearing loose clothing, jewelry, or other items that can catch on control levers or other parts of the machine.
- Operating equipment safely requires the full attention of the operator. Do not wear radio or music headphones while operating the machine.

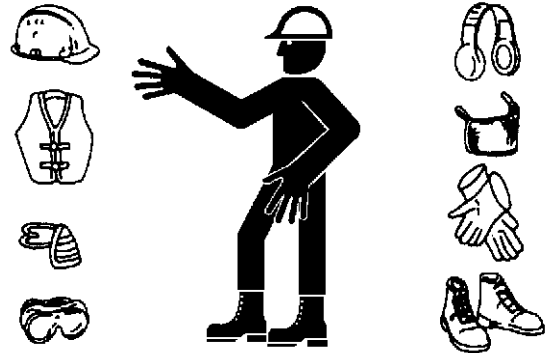

SA-438

005-E01A-0438

### PROTECT AGAINST NOISE

- Prolonged exposure to loud noise can cause impairment or loss of hearing.
- Wear a suitable hearing protective device such as earmuffs or earplugs to protect against objectionable or uncomfortably loud noises.



006-E01A-0434

SA-434

### INSPECT MACHINE

- Inspect your machine carefully each day or shift by walking around it before you start it to avoid personal injury.
- In the walk-around inspection, be sure to cover all points described in the “PRE-START INSPECTION” chapter in the operator’s manual.



007-E01A-0435

SA-435

# SAFETY

---

## GENERAL PRECAUTIONS FOR CAB

- Before entering the cab, thoroughly remove all dirt and/or oil from the soles of your work boots. If any controls such as a pedal is operated while with dirt and/or oil on the soles of the operator's work boots the operator's foot may slip off the pedal, possibly resulting in a personal accident.
- Don't leave parts and/or tools lying around the operator's seat. Store them in their specified locations.
- Avoid storing transparent bottles in the cab. Don't attach any transparent type window decorations on the windowpanes as they may focus sunlight, possibly starting a fire.
- Refrain from listening to the radio, or using music headphones or mobile telephones in the cab while operating the machine.
- Keep all flammable objects and/or explosives away from the machine.
- After using the ashtray, always cover it to extinguish the match and/or tobacco.
- Don't leave cigarette lighters in the cab. When the temperature in the cab increases, the lighter may explode.

524-E01A-0000

## SAFETY

---

### USE HANDHOLDS AND STEPS

- Falling is one of the major causes of personal injury.
  - When you get on and off the machine, always face the machine and maintain a three-point contact with the steps and handrails.
  - Do not use any controls as handholds.
  - Never jump on or off the machine. Never mount or dismount a moving machine.
  - Be careful of slippery conditions on platforms, steps, and handrails when leaving the machine.



SA-439

008-E01A-0439

---

### ADJUST THE OPERATOR'S SEAT

- A poorly adjusted seat for either the operator or for the work at hand may quickly fatigue the operator leading to misoperations.
  - The seat should be adjusted whenever changing the operator for the machine.
  - The operator should be able to fully depress the pedals and to correctly operate the control levers with his back against the seat back.
  - If not, move the seat forward or backward, and check again.



SA-378

009-E01A-0378

## SAFETY

---

### FASTEN YOUR SEAT BELT

- If the machine should overturn, the operator may become injured and/or thrown from the cab. Additionally the operator may be crushed by the overturning machine, resulting in serious injury or death.
- Prior to operating the machine, thoroughly examine webbing, buckle and attaching hardware. If any item is damaged or worn, replace the seat belt or component before operating the machine.
- Be sure to remain seated with the seat belt securely fastened at all times when the machine is in operation to minimize the chance of injury from an accident.
- We recommend that the seat belt be replaced every three years regardless of its apparent condition.

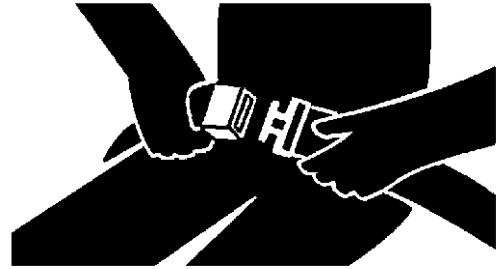

SA-237

010-E01A-0237

### MOVE AND OPERATE MACHINE SAFELY

- Bystanders can be run over.
- Take extra care not to run over bystanders. Confirm the location of bystanders before moving, swinging, or operating the machine.
- Always keep the travel alarm and horn in working condition (if equipped). It warns people when the machine starts to move.
- Use a signal person when moving, swinging, or operating the machine in congested areas. Coordinate hand signals before starting the machine.

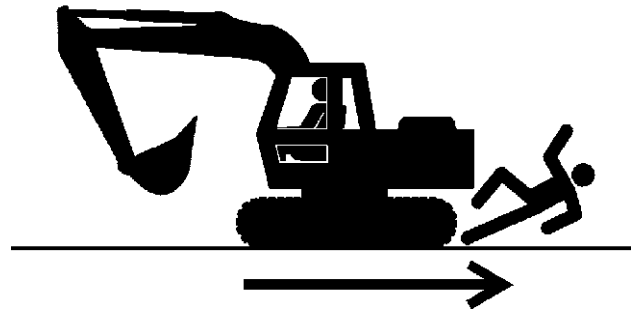

SA-426

011-E01A-0426

## SAFETY

---

### OPERATE ONLY FROM OPERATOR'S SEAT

- Inappropriate engine starting procedures may cause the machine to runaway, possibly resulting in serious injury or death.
- Start the engine only from the operator's seat.
- NEVER start the engine while standing on the track or on ground.
- Do not start engine by shorting across starter terminals.
- Before starting the engine, confirm that all control levers are in neutral.



SA-444

012-E01B-0444

---

### JUMP STARTING

- Battery gas can explode, resulting in serious injury.
- If the engine must be jump started, be sure to follow the instructions shown in the "OPERATING THE ENGINE" chapter.
- The operator must be in the operator's seat so that the machine will be under control when the engine starts. Jump starting is a two-person operation.
- Never use a frozen battery.
- Failure to follow correct jump starting procedures could result in a battery explosion or a runaway machine.

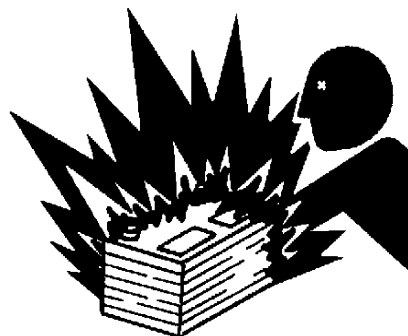

SA-032

S013-E01A-0032

---

### KEEP RIDERS OFF MACHINE

- Riders on machine are subject to injury such as being struck by foreign objects and being thrown off the machine.
- Only allow the operator on the machine. Keep riders off.
- Riders also obstruct the operator's view, resulting in the machine being operated in an unsafe manner.

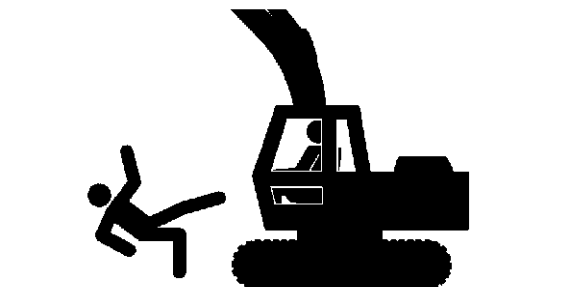

SA-379

014-E01B-0379

# SAFETY

## INVESTIGATE JOB SITE BEFOREHAND

- When working at the edge of an excavation or on a road shoulder, the machine could tip over, possibly resulting in serious injury or death.
- Investigate the configuration and ground conditions of the job site beforehand to prevent the machine from falling and to prevent the ground, stockpiles, or banks from collapsing.
- Make a work plan. Use machines appropriate to the work and job site.
- Reinforce ground, edges, and road shoulders as necessary. Keep the machine well back from the edges of excavations and road shoulders.
- When working on an incline or on a road shoulder, employ a signal person as required.
- Confirm that your machine is equipped a FOPS cab before working in areas where the possibility of falling stones or debris exist.
- When the footing is weak, reinforce the ground before starting work.
- When working on frozen ground, be extremely alert. As ambient temperatures rise, footing becomes loose and slippery.
- Beware the possibility of fire when operating the machine near flammable objects such as dry grass.

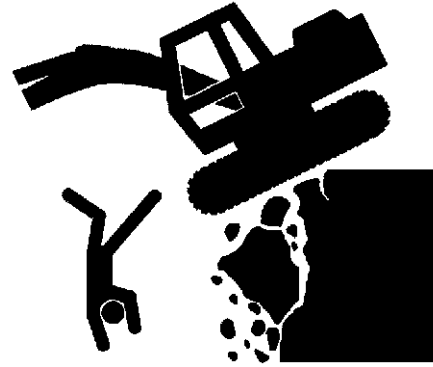

SA-380

015-E01A-0380

## PROTECT AGAINST FALLING STONES AND DEBRIS

- Confirm that your machine is FOPS cab equipped before working in areas where the possibility of falling stones or debris exist.

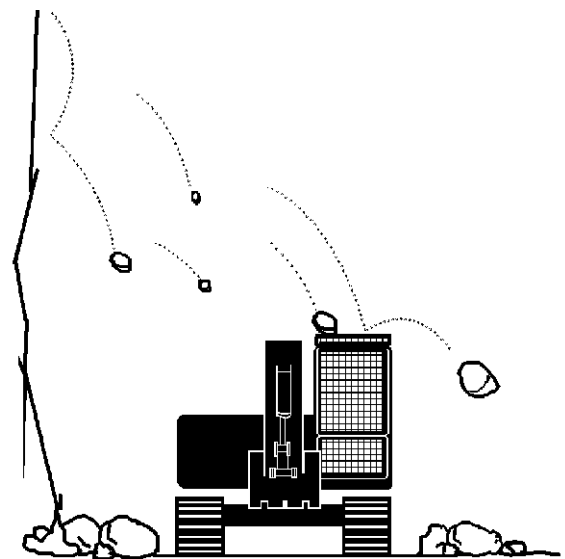

SA-490

015-E01A-0380

## SAFETY

---

### PROVIDE SIGNALS FOR JOBS INVOLVING MULTIPLE NUMBERS OF MACHINES

- For jobs involving multiple numbers of machines, provide signals commonly known by all personnel involved. Also, appoint a signal person to coordinate the job site. Make sure that all personnel obey the signal person's directions.



018-E01A-0481

SA-481

### CONFIRM DIRECTION OF MACHINE TO BE DRIVEN

- Incorrect travel pedal/lever operation may result in serious injury death.
- Before driving the machine, confirm the position of the undercarriage in relation to the operator's position. If the travel motors are located in front of the cab, the machine will move in reverse when travel pedals/levers are operated to the front.

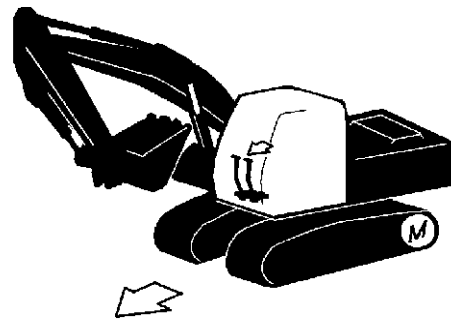

017-E01A-0491

SA-491

# SAFETY

## DRIVE MACHINE SAFELY

- Before driving the machine, always confirm that the travel levers/pedals direction corresponds to the direction you wish to drive.
- Be sure to detour around any obstructions.
- Avoid traveling over obstructions. Soil, fragments of rocks, and/or metal pieces may scatter around the machine. Don't allow personnel to stay around the machine while traveling.
- Driving on a slope may cause the machine to slip or overturn, possibly resulting in serious injury or death.
- When driving up or down a slope, keep the bucket facing the direction of travel, approximately 0.5 to 1.0 m (A) above the ground.
- If the machine starts to skid or becomes unstable, immediately lower the bucket to the ground and stop.

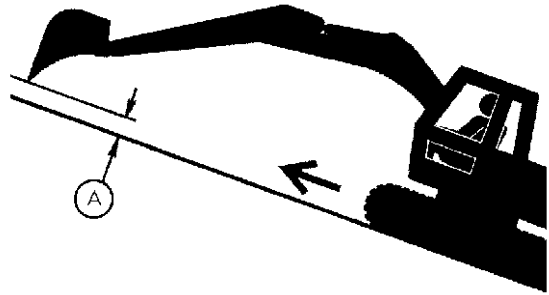

SA-387

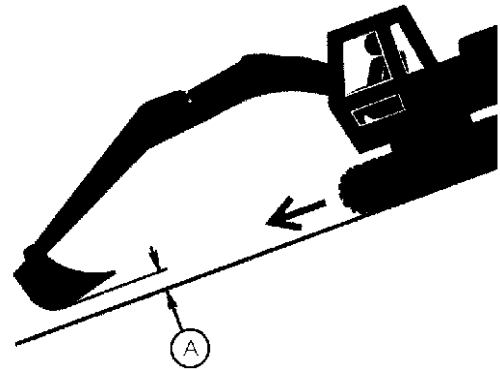

SA-388

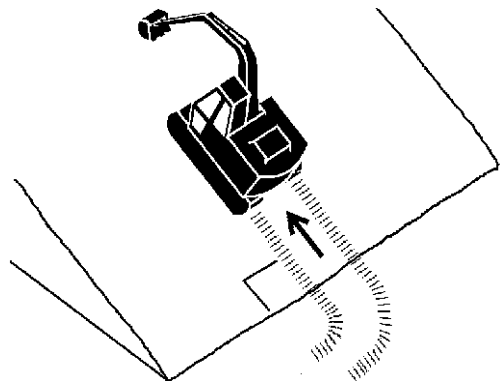

SA-441

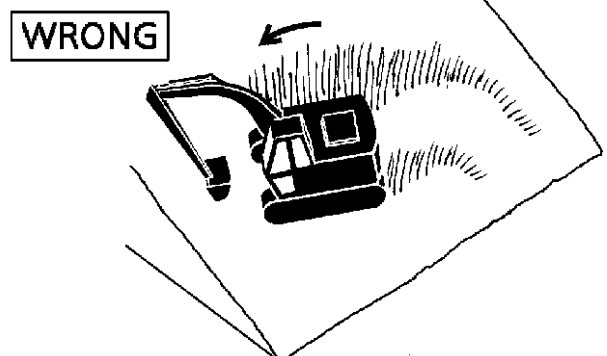

SA-589

- Driving across the face of a slope or steering on a slope may cause the machine to skid or turnover. If the direction must be changed, move the machine to level ground, then, change the direction to ensure safe operation.

019-E01C-0492

## SAFETY

### AVOID INJURY FROM ROLLAWAY ACCIDENTS

- Death or serious injury may result if you attempt to mount or stop a moving machine.

To avoid rollaways:

- Select level ground when possible to park machine.
- Do not park the machine on a grade.
- Lower the bucket and/or other work tools to the ground.
- Turn the auto-idle switch and the H/P mode switch off.
- Run the engine at slow idle speed without load for 5 minutes to cool down the engine.
- Stop the engine and remove the key from the key switch.
- Pull the pilot control shut-off lever to LOCK position.
- Block both tracks and lower the bucket to the ground. Thrust the bucket teeth into the ground if you must park on a grade.
- Position the machine to prevent rolling.
- Park a reasonable distance from other machines.

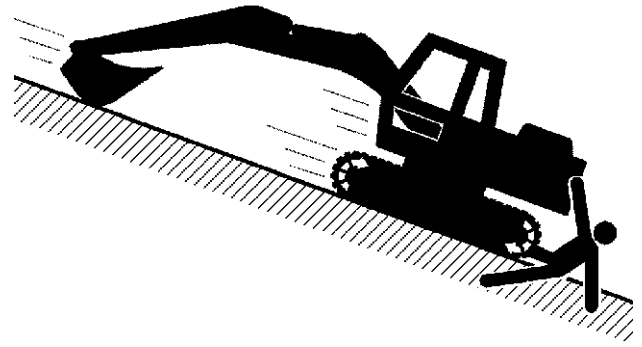

SA-391

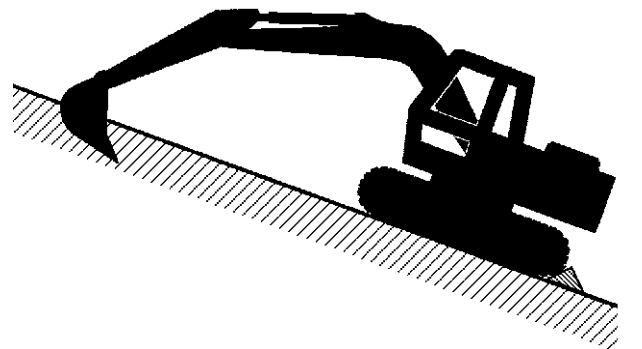

SA-392

020-E02A-0493

## SAFETY

---

### AVOID INJURY FROM BACK-OVER AND SWING ACCIDENTS

- If any person is present near the machine when backing or swinging the upperstructure, the machine may hit or run over that person, resulting in serious injury or death.

To avoid back-over and swing accidents:

- Always look around **BEFORE YOU BACK UP AND SWING THE MACHINE**. BE SURE THAT ALL BYSTANDERS ARE CLEAR.
- Keep the travel alarm in working condition (if equipped).  
ALWAYS BE ALERT FOR BYSTANDERS MOVING INTO THE WORK AREA. USE THE HORN OR OTHER SIGNAL TO WARN BYSTANDERS BEFORE MOVING MACHINE.
- USE A SIGNAL PERSON WHEN BACKING UP IF YOUR VIEW IS OBSTRUCTED. ALWAYS KEEP THE SIGNAL PERSON IN VIEW.  
Use hand signals, which conform to your local regulations, when work conditions require a signal person.
- No machine motions shall be made unless signals are clearly understood by both signalman and operator.
- Learn the meanings of all flags, signs, and markings used on the job and confirm who has the responsibility for signaling.
- Keep windows, mirrors, and lights clean and in good condition.
- Dust, heavy rain, fog, etc., can reduce visibility. As visibility decreases, reduce speed and use proper lighting.
- Read and understand all operating instructions in the operator's manual.

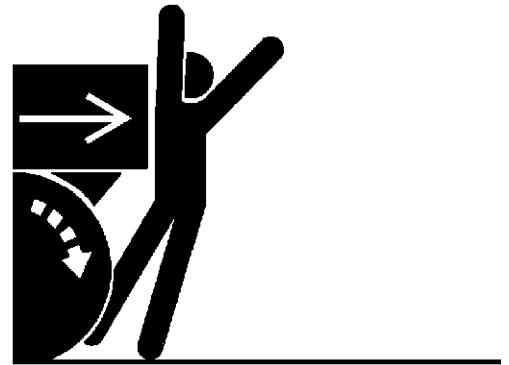

SA-383

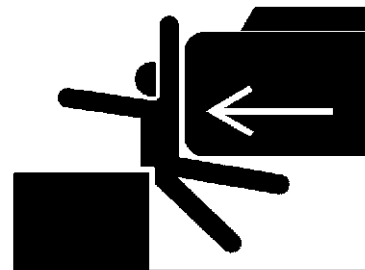

SA-384

021-E01A-0494

## SAFETY

### KEEP PERSON CLEAR FROM WORKING AREA

- A person may be hit severely by the swinging front attachment or counterweight and/or may be crushed against an other object, resulting in serious injury or death.
- Keep all persons clear from the area of operation and machine movement.
- Before operating the machine, set up barriers to the sides and rear area of the bucket swing radius to prevent anyone from entering the work area.

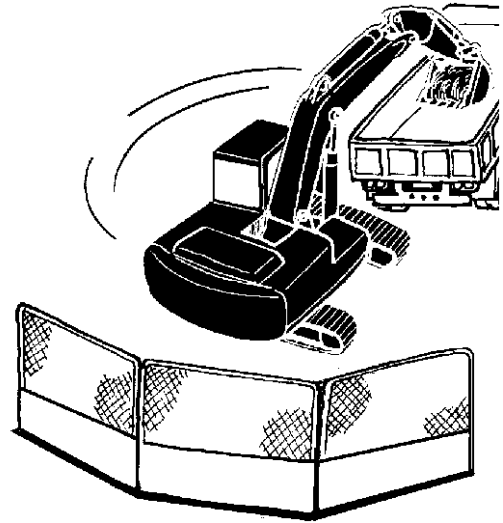

022-E01A-0386

SA-386

### NEVER POSITION BUCKET OVER ANYONE

- Never lift, move, or swing bucket above anyone or a truck cab. Serious injury or machine damage may result due to bucket load spill or due to collision with the bucket.



023-E01A-0487

SA-487

### AVOID UNDERCUTTING

- In order to retreat from the edge of an excavation if the footing should collapse, always position the undercarriage perpendicular to the edge of the excavation with the travel motors at the rear.
- If the footing starts to collapse and if retreat is not possible, do not panic. Often, the machine can be secured by lowering the front attachment, in such cases.

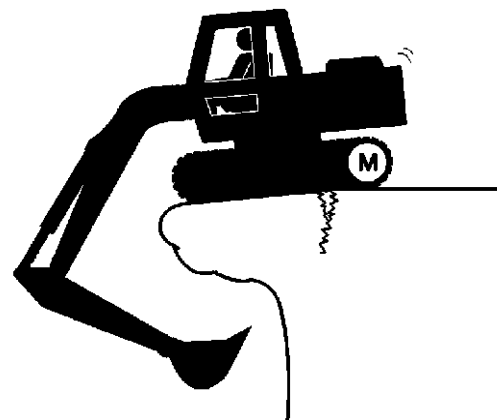

024-E01A-0488

SA-488



**Suggest:**

**For more complete manuals. Please go to the home page.**

**<https://www.ebooklibonline.com>**

**If the above button click is invalid. Please download this document first, and then click the above link to download the complete manual.**

**Thank you so much for reading**

## SAFETY

### AVOID TIPPING

**DO NOT ATTEMPT TO JUMP CLEAR OF TIPPING MACHINE --- SERIOUS OR FATAL CRUSHING INJURIES WILL RESULT**

**MACHINE WILL TIP OVER FASTER THAN YOU CAN JUMP FREE**

**FASTEN YOUR SEAT BELT**

- The danger of tipping is always present when operating on a grade, possibly resulting in serious injury or death.

To avoid tipping:

- Be extra careful before operating on a grade.
  - Prepare machine operating area flat.
  - Keep the bucket low to the ground and close to the machine.
  - Reduce operating speeds to avoid tipping or slipping.
  - Avoid changing direction when traveling on grades.
  - NEVER attempt to travel across a grade steeper than 15 degrees if crossing the grade is unavoidable.
  - Reduce swing speed as necessary when swinging loads.
- Be careful when working on frozen ground.
  - Temperature increases will cause the ground to become soft and make ground travel unstable.

025-E01B-0495

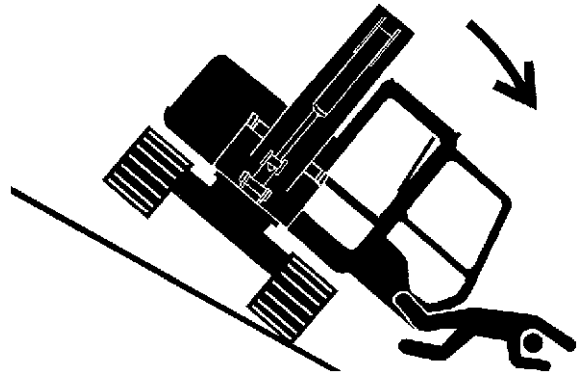

SA-012

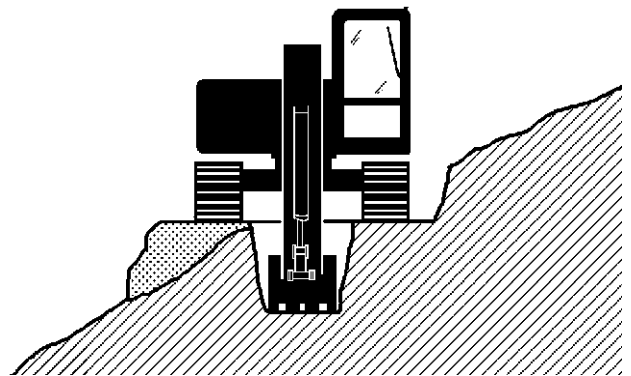

SA-440

### NEVER UNDERCUT A HIGH BANK

- The edges could collapse or a land slide could occur causing serious injury or death.



SA-489

026-E01A-0489

## SAFETY

---

### DIG WITH CAUTION

- Accidental severing of underground cables or gas lines may cause an explosion and/or fire, possibly resulting in serious injury or death.
  - Before digging check the location of cables, gas lines, and water lines.
  - Keep the minimum distance required, by law, from cables, gas lines, and water lines.
  - If a fiber optic cable should be accidentally severed, do not look into the end. Doing so may result in serious eye injury.
  - Contact your local “diggers hot line” if available in your area, and/or the utility companies directly. Have them mark all underground utilities.

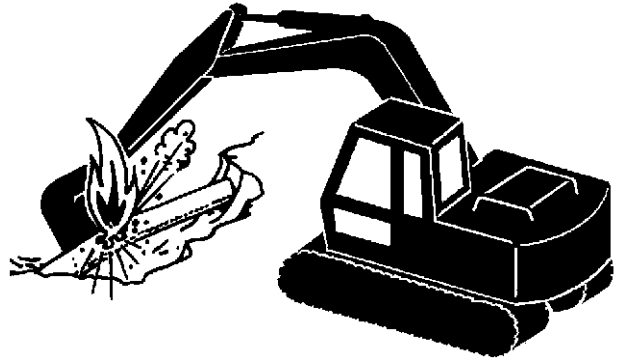

SA-382

027-E01A-0382

### OPERATE WITH CAUTION

- If the front attachment or any other part of the machine hits against an overhead obstacle, such as a bridge, both the machine and the overhead obstacle will be damaged, and personal injury may result as well.
  - Take care to avoid hitting overhead obstacles with the boom or arm.

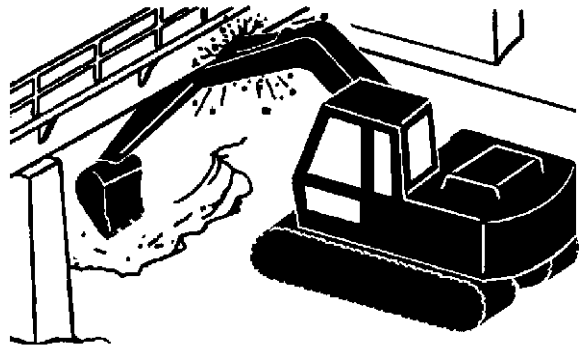

028-E01A-0389

SA-389

### AVOID POWER LINES

- Serious injury or death can result if the machine or front attachments are not kept a safe distance from electric lines.
  - When operating near an electric line, NEVER move any part of the machine or load closer than 3 m plus twice the line insulator length.
  - Check and comply with any local regulations that may apply.
  - Wet ground will expand the area that could cause any person on it to be affected by electric shock. Keep all bystanders or co-workers away from the site.

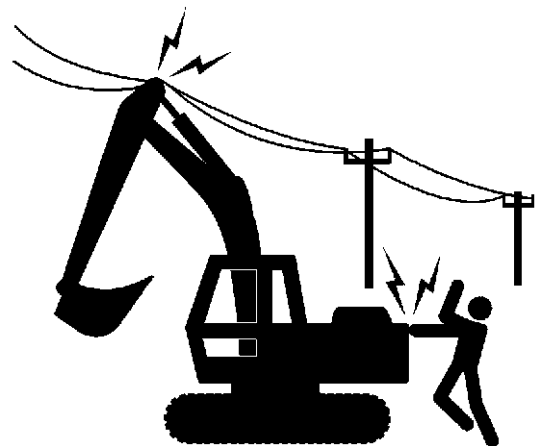

SA-381

029-E01A-0381

**<https://www.ebooklibonline.com>**

Hello dear friend!

Thank you very much for reading.

Enter the link into your browser.

The full manual is available for immediate download.

**<https://www.ebooklibonline.com>**