

Product: VIBRATORY COMPACTOR

Model: CB-54B VIBRATORY COMPACTOR RJN

Configuration: CB44B and CB54B Asphalt Compactor RJN00001-UP (MACHINE) POWERED BY C4.4 Engine

Disassembly and Assembly CB54B Vibratory Asphalt Compactor Machine Systems

Media Number -UENR3258-08

Publication Date -01/12/2014

Date Updated -29/11/2017

i04891308

Piston Pump (Vibratory) - Disassemble - Split Drum

SMCS - 5070-015; 5652-015

Disassembly Procedure

Table 1

Required Tools			
Tool	Part Number	Part Description	Qty
A	1P-1861	Retaining Ring Pliers	1
B	1P-0074	Slide Hammer Puller Gp	1
C	1P-0510	Driver Gp	1
D	1P-1864	Retaining Ring Pliers As	1

Start By:

- a. Remove the piston pump (vibratory).

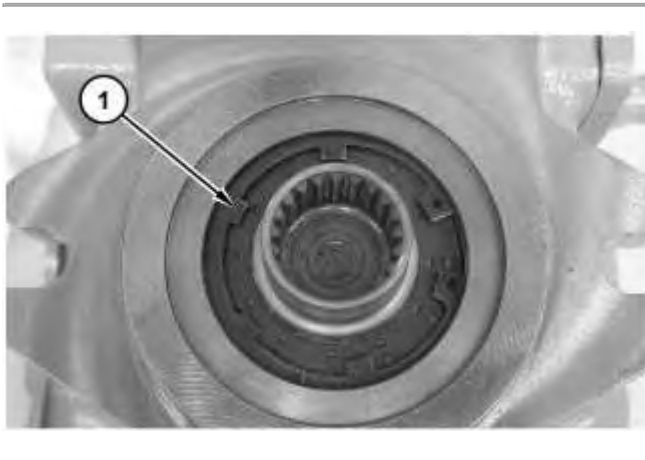

1. Use Tooling (A) in order to remove retaining ring (1).

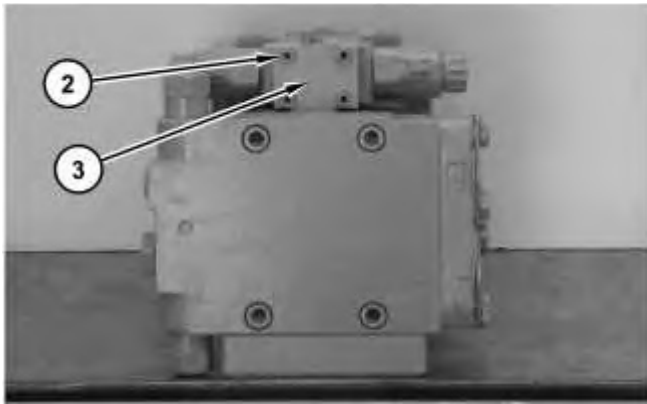

Illustration 2

2. Remove bolts (2). Remove valve assembly (3).

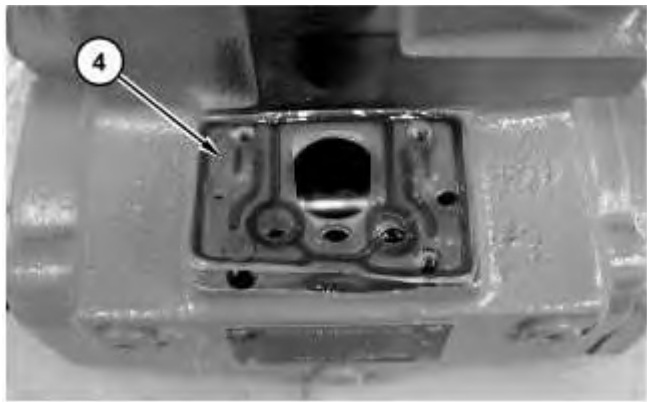

Illustration 3

3. Remove gasket (4).

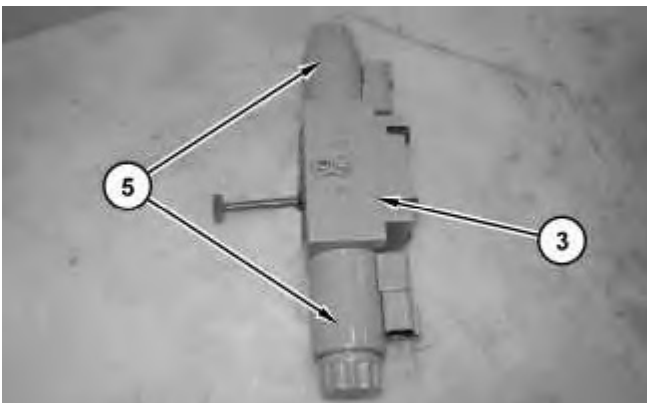

Illustration 4

4. Remove solenoid assemblies (5) from valve assembly (3).

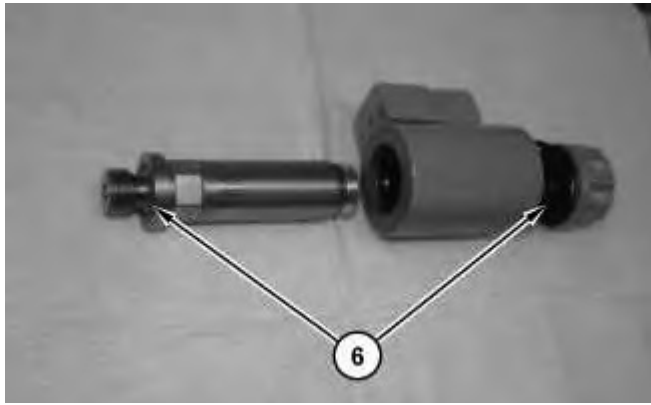

Illustration 5

g03025579

5. Remove O-ring seals (6).

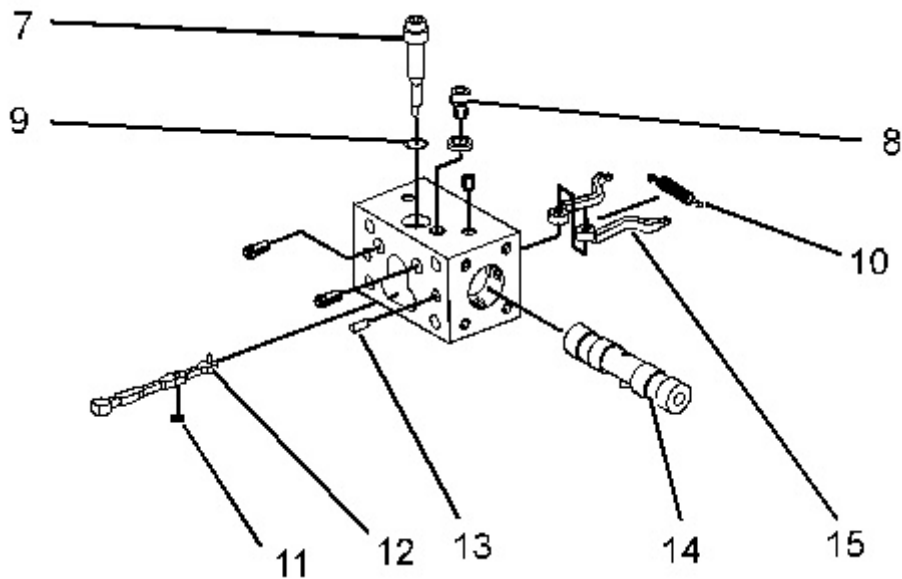

Illustration 6

g03025618

6. Remove bolt (8), eccentric pin (7), and O-ring seal (9).
 7. Remove spring (10), pins (13), levers (12) and (15), and shims (11).
 8. Remove spool (14).
-

<https://www.ebooklibonline.com>

Hello dear friend!

Thank you very much for reading.

Enter the link into your browser.

The full manual is available for immediate download.

<https://www.ebooklibonline.com>

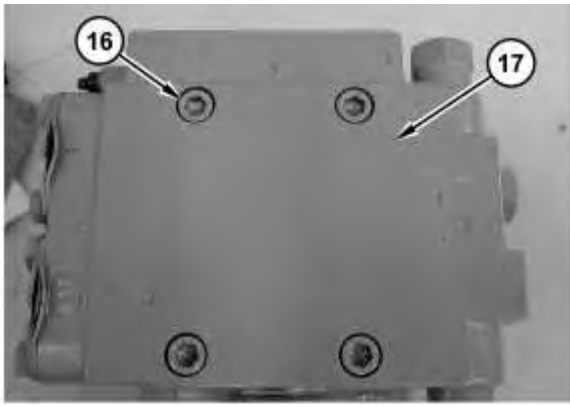

Illustration 7

g03025739

9. Remove bolts (16) and remove head (17).

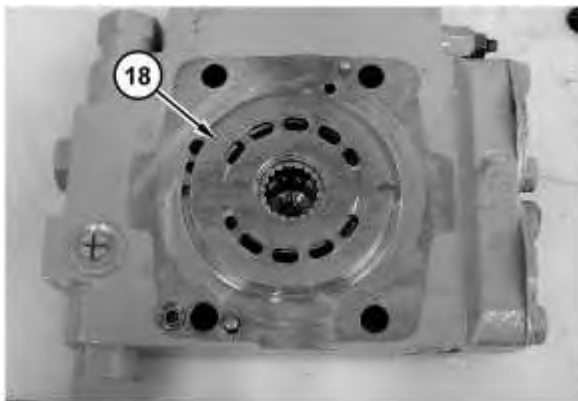

Illustration 8

g03025741

10. Remove port plate (18).



Illustration 9

g03025742

11. Remove plug (19).
-

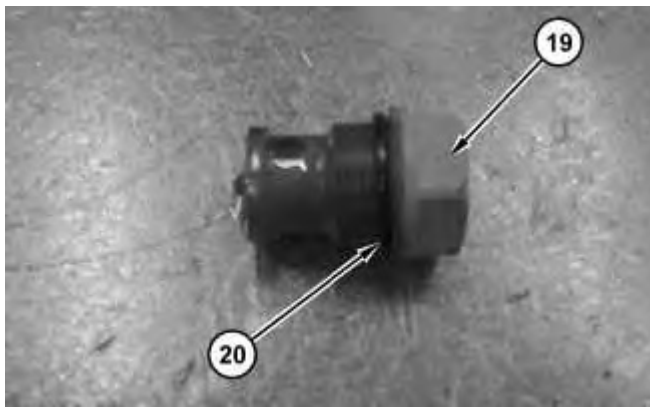

Illustration 10

g03025758

12. Remove O-ring seal (20) from plug (19).

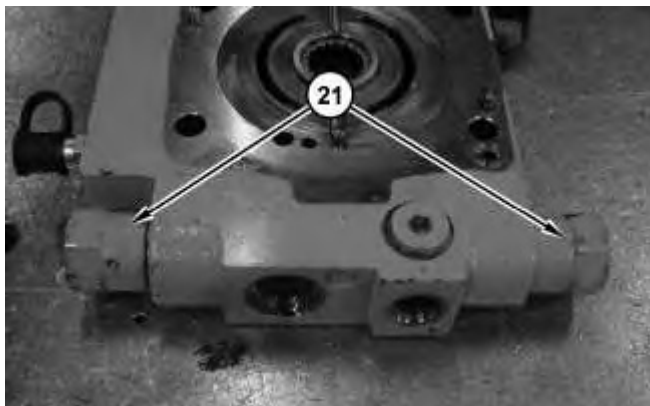

Illustration 11

g03025760



Personal injury can result from being struck by parts propelled by a released spring force.

Make sure to wear all necessary protective equipment.

Follow the recommended procedure and use all recommended tooling to release the spring force.

13. Remove plugs (21).
-

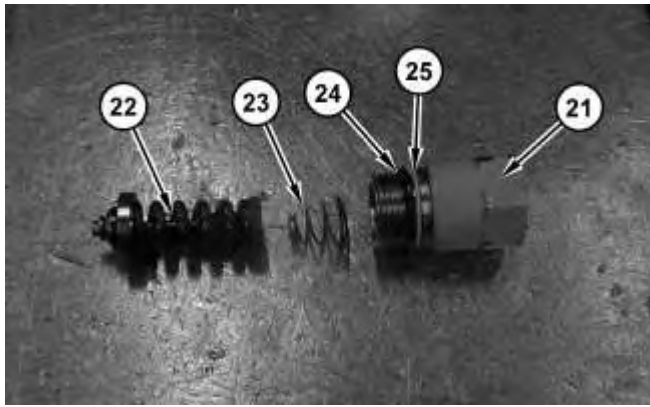

Illustration 12

g03025761

14. Remove the following items from plug (21): backup ring (25), O-ring seal (24), spring (23) and spring (22).

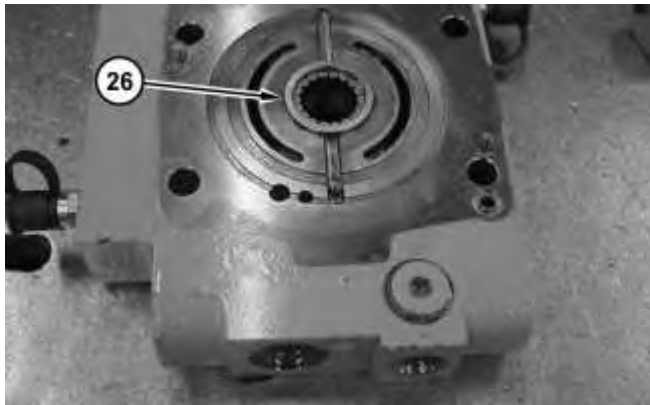

Illustration 13

g03025762

15. Use Tooling (B) in order to remove bearing (26).



Illustration 14

g03025765

16. Remove valve (27).

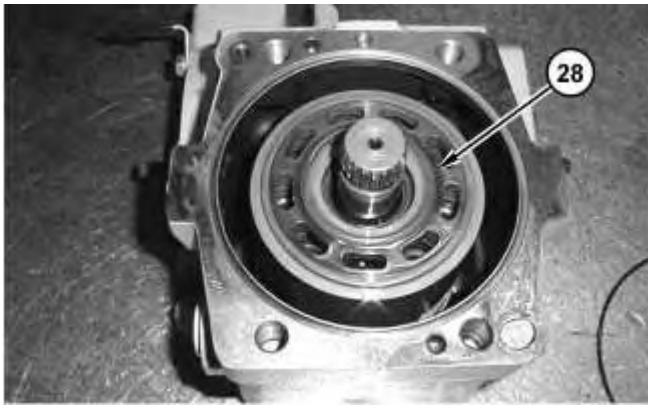

Illustration 15

g03025767

17. Remove rotating group (28).

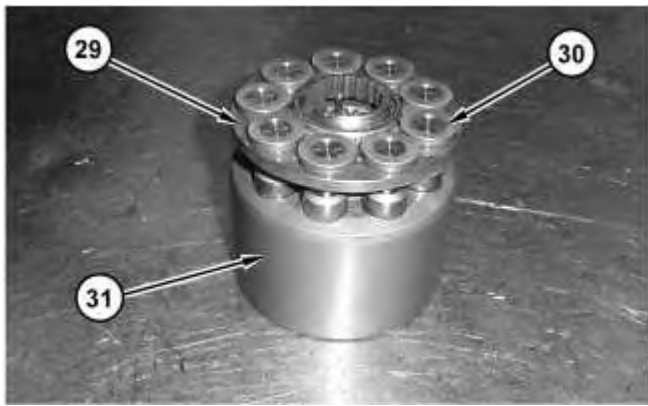

Illustration 16

g03025876

18. Remove pistons (30) and retainer plate (29) from barrel assembly (31).

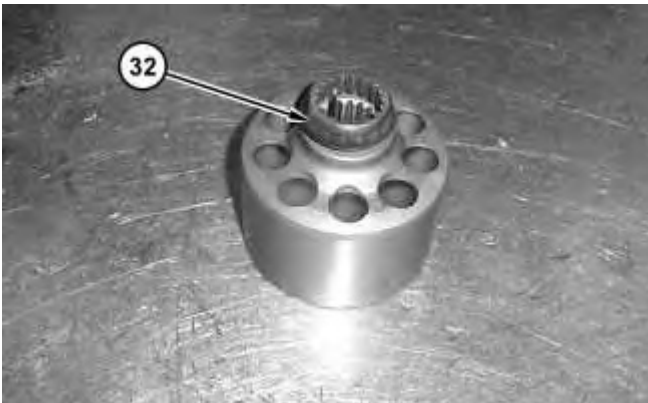

Illustration 17

g03025877

19. Remove retainer (32).

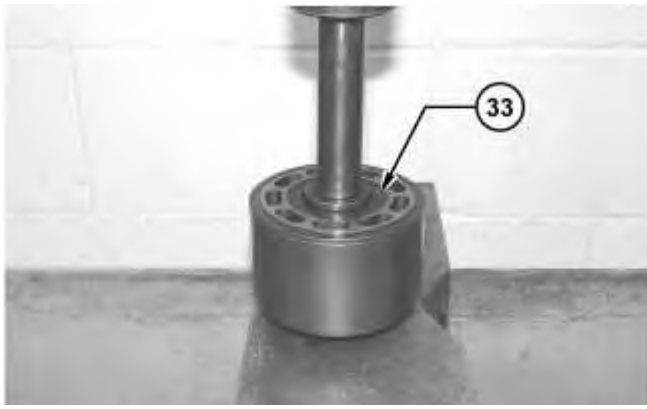

Illustration 18

g03025879

! WARNING

Personal injury can result from being struck by parts propelled by a released spring force.

Make sure to wear all necessary protective equipment.

Follow the recommended procedure and use all recommended tooling to release the spring force.

20. Use Tooling (C) and a suitable press in order to remove one retaining ring (33) (not shown).

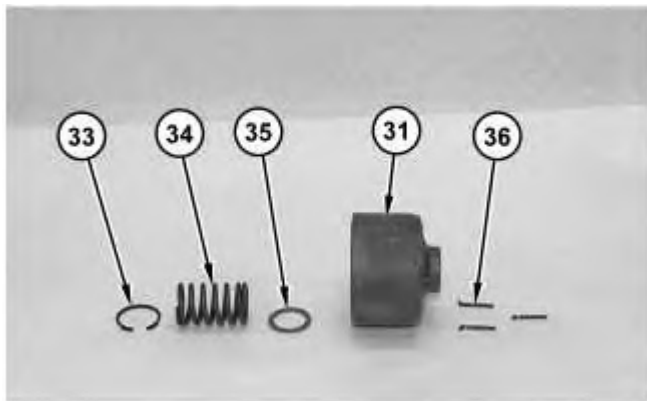

Illustration 19

g03025880

21. Remove the following items from barrel assembly (31): retaining ring (33), spring (34), washer (35) and pins (36).



Illustration 20

g03025916

22. Remove O-ring seal (37) and O-ring seal (38).

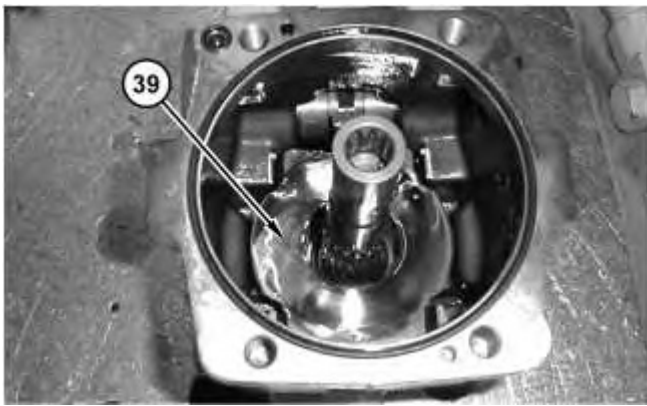

Illustration 21

g03025917

23. Remove swashplate assembly (39).

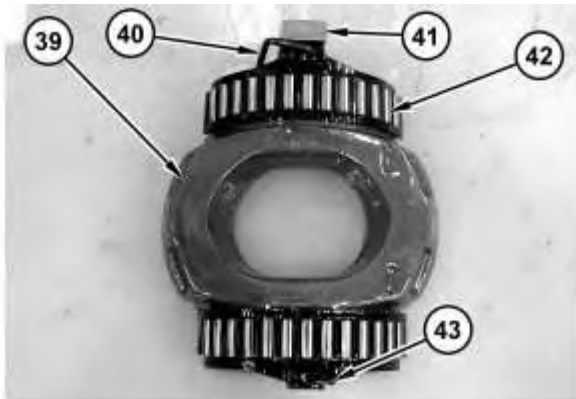

Illustration 22

g03025938

24. Remove the following items from swashplate assembly (39): pin (40), block (41), bearings (42) and pin (43).

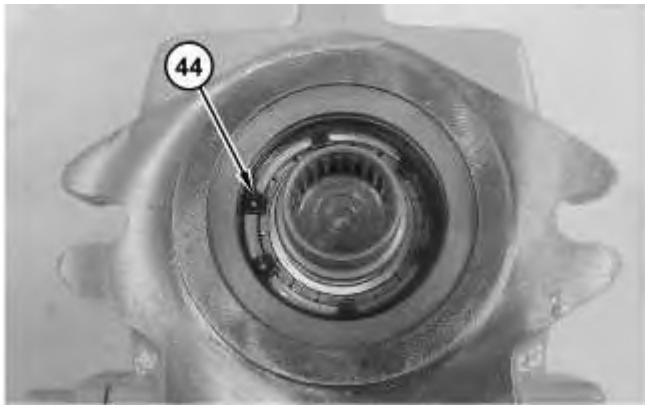

Illustration 23

g03025919

25. Use Tooling (A) in order to remove retaining ring (44).

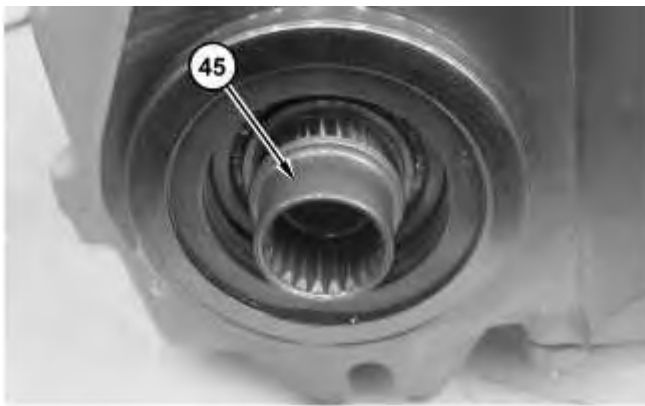

Illustration 24

g03025922

26. Remove shaft assembly (45).

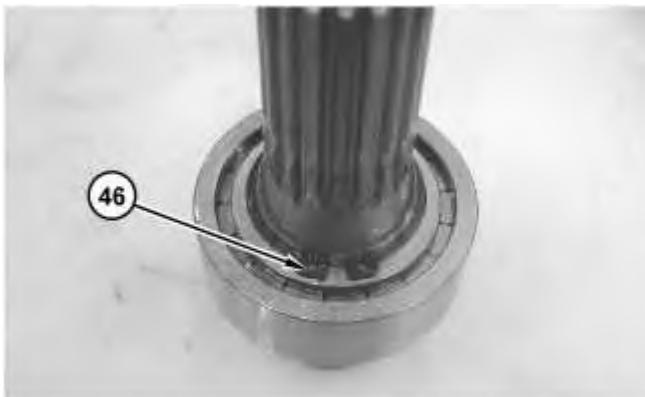

Illustration 25

g03025925

27. Use Tooling (D) in order to remove retaining ring (46).
-

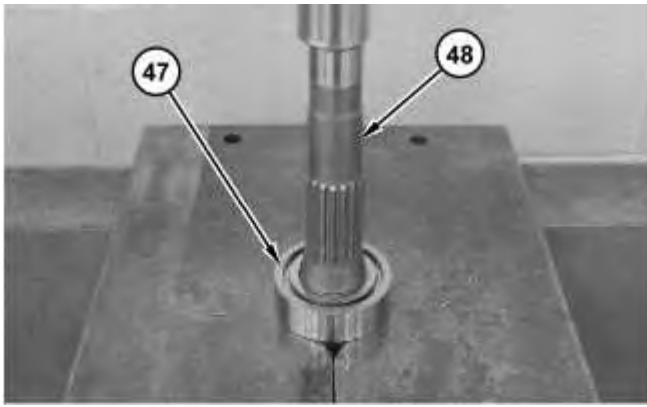

Illustration 26

g03025941

28. Use a suitable press in order to remove bearing (47) from shaft (48).

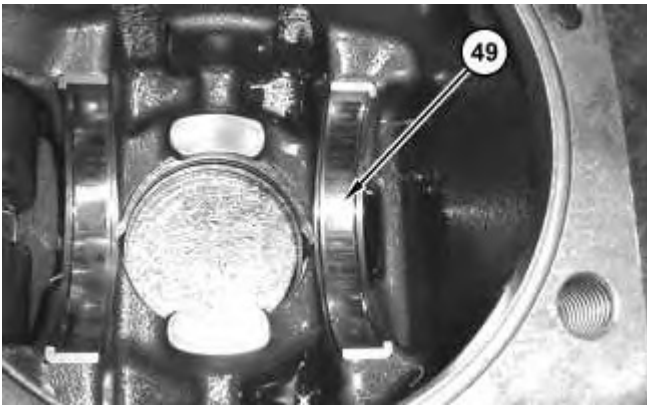

Illustration 27

g03025945

29. Remove bearing races (49).



Illustration 28

g03025956

30. Remove bolts (50) and cover (51).

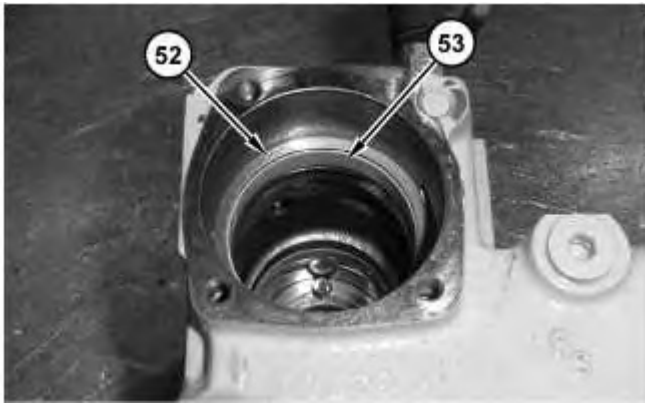

Illustration 29

g03025958

31. Remove seal (52) and guide rings (53).

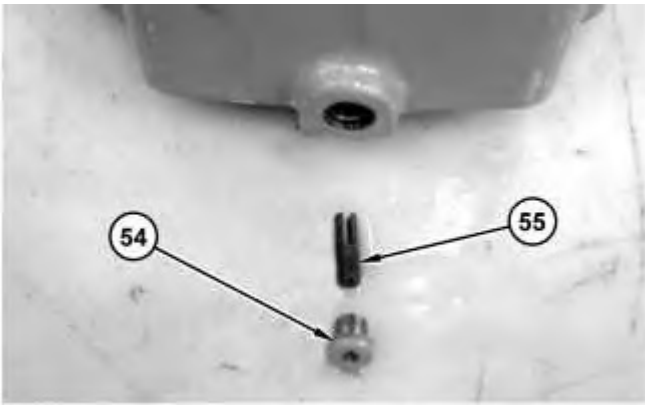

Illustration 30

g03025960

32. Remove plug (54) and pin retainer (55).

Product: VIBRATORY COMPACTOR

Model: CB-54B VIBRATORY COMPACTOR RJN

Configuration: CB44B and CB54B Asphalt Compactor RJN00001-UP (MACHINE) POWERED BY C4.4 Engine

Disassembly and Assembly CB54B Vibratory Asphalt Compactor Machine Systems

Media Number -UENR3258-08

Publication Date -01/12/2014

Date Updated -29/11/2017

i04889364

Piston Pump (Vibratory) - Assemble - Solid Drum

SMCS - 5070-016; 5652-016

Assembly Procedure

Table 1

Required Tools			
Tool	Part Number	Part Description	Qty
C	0S-1527	Bolt	1
	2J-3506	Full Nut	1
	8T-4122	Hard Washer	2
D	1P-1859	Retaining Ring Pliers	1
E	9S-3263	Thread Lock Compound	1

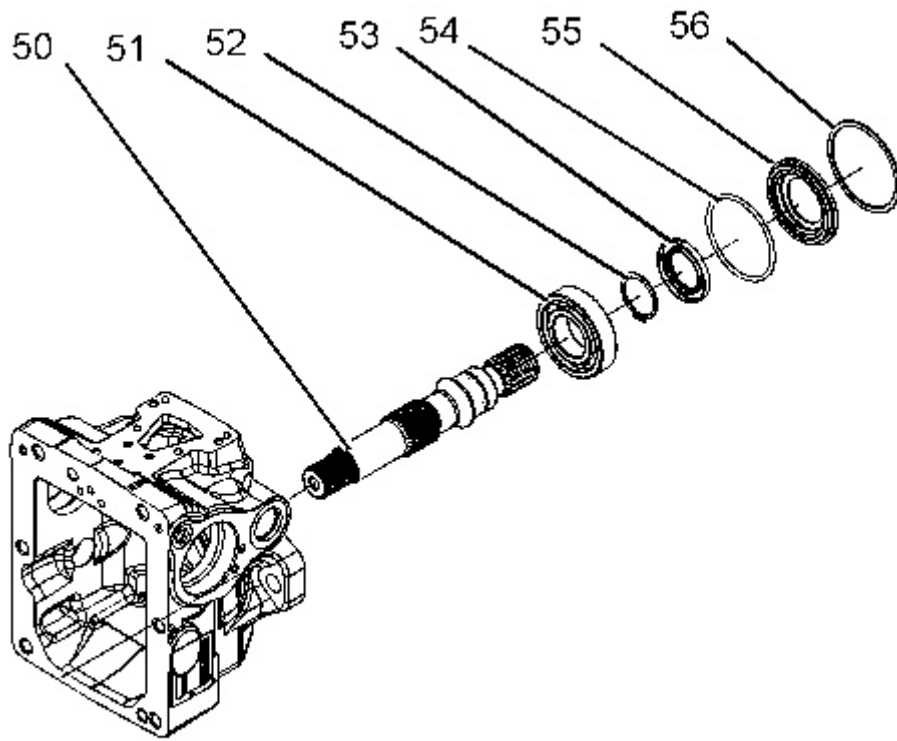
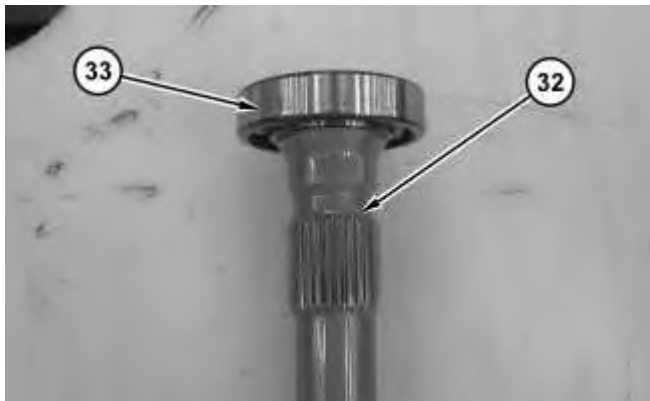

Illustration 1

g01375101

1. Raise the temperature of bearing (51).
2. Install bearing (51).
3. Use Tooling (D) in order to install retaining ring (52).
4. Install shaft assembly (50) and seal (53).
5. Install O-ring seal (54).
6. Install plate (55).
7. Install retaining ring (56).



8. Raise the temperature of bearing (33).
9. Install bearing (33) onto shaft (32).

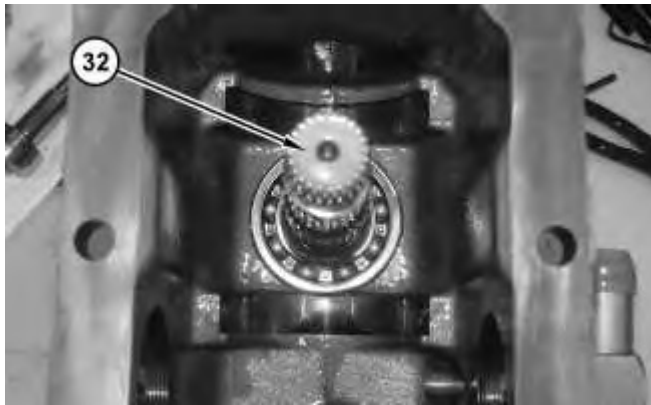

Illustration 3

10. Install shaft (32).



Illustration 4

11. Install bearings (31) onto swashplate (28).

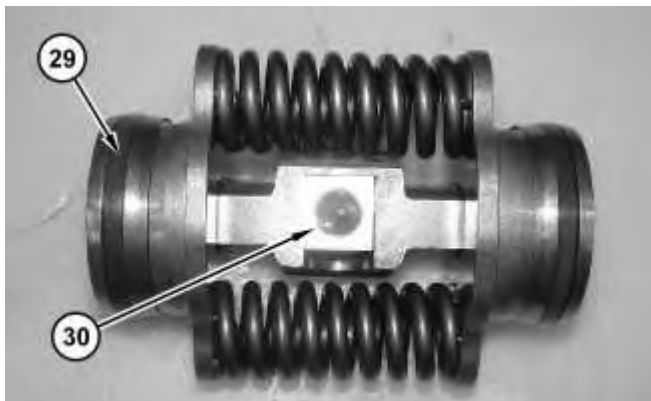

12. Install seals (29) and block (30).

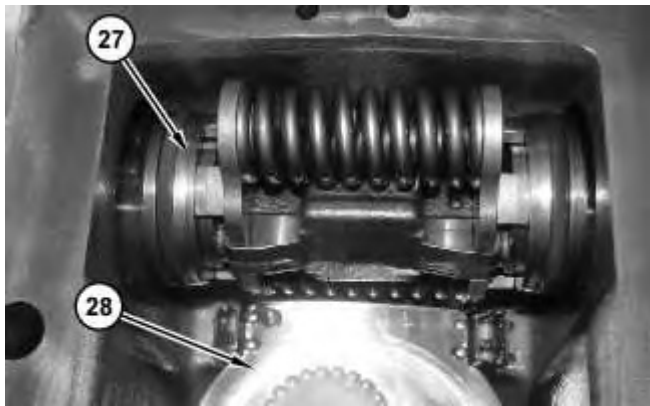

Illustration 6

13. Install piston assembly (27) and swashplate (28).



Illustration 7

14. Install O-ring seal (26).

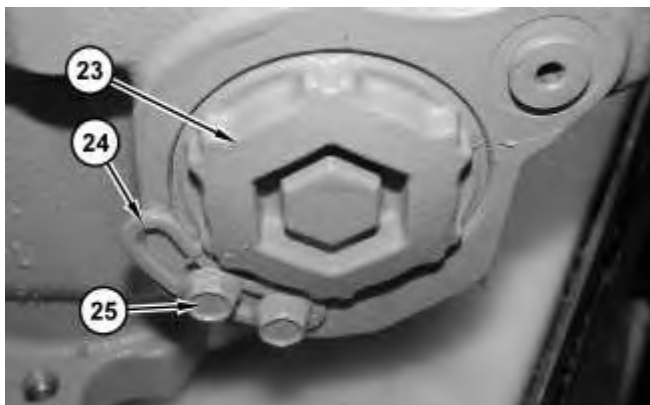

Illustration 8

15. Install set screw (23). Apply slight pressure to the piston assembly.
16. Repeat Step 15 for the opposite side.
17. Use a suitable measuring device in order to center the swashplate. Measure the distance that is from the machined face of the housing to both sides of the swashplate. Adjust setscrews (23) in order to achieve the same distance to the swashplate.
18. Install retainer (24), and bolts (25).

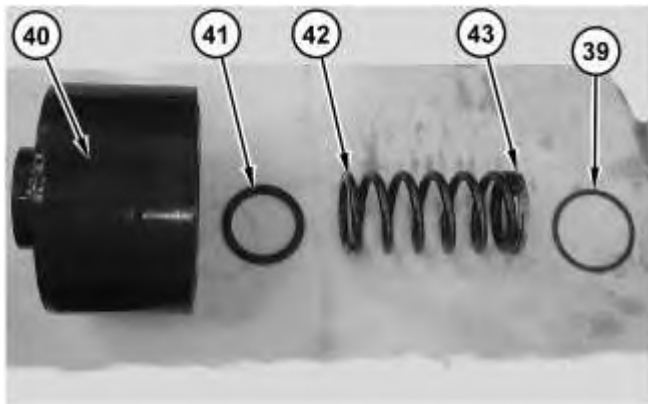

Illustration 9

g01325570

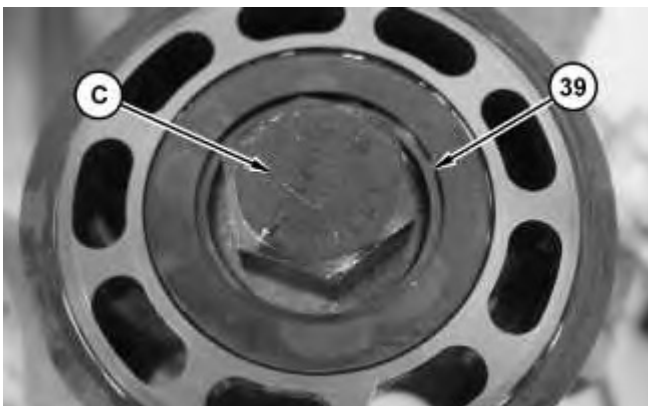

Illustration 10

g01325569

 **WARNING**

Improper assembly of parts that are spring loaded can cause bodily injury.

To prevent possible injury, follow the established assembly procedure and wear protective equipment.

19. Install washer (41), spring (42), and retainer (43) into barrel (40).

20. Use Tooling (C) in order to install retaining ring (39).

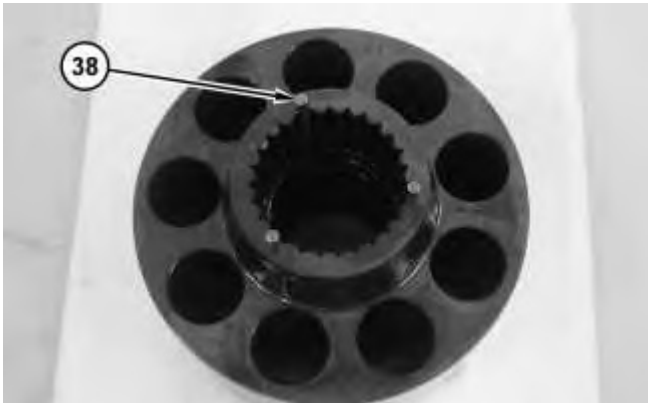

Illustration 11

g01325568

21. Install pins (38).

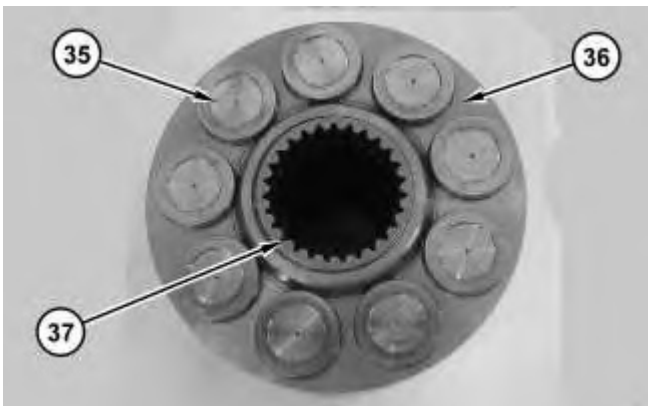

Illustration 12

g01325566

22. Install bearing (37), retainer (36), and pistons (35).

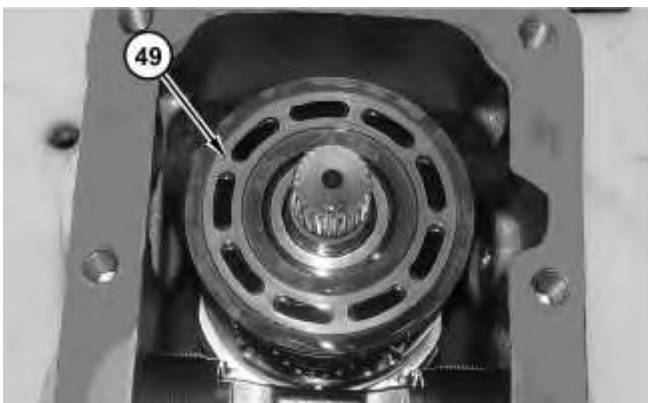

Illustration 13

g01325574

23. Repeat Steps 19 through Steps 22 for barrel assembly (49).

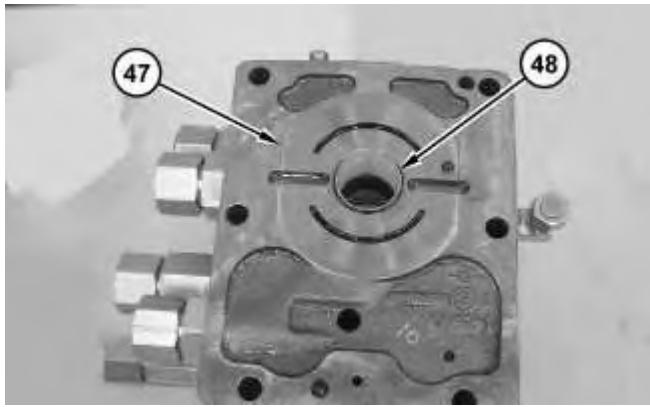

Illustration 14

g01325573

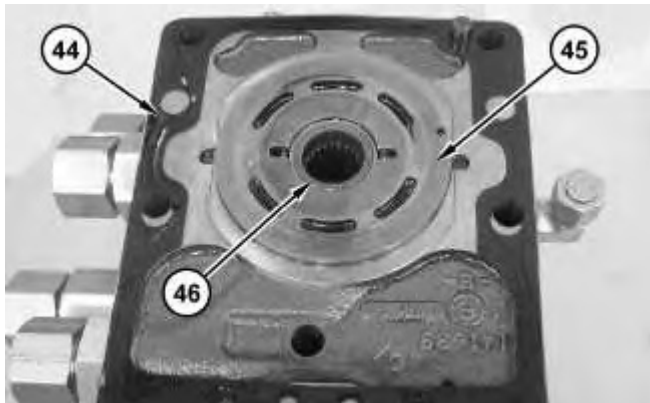

Illustration 15

g01325572

24. Install bearings (48).
25. Install port plate (45) and gasket (44).
26. Install head (47).
27. Repeat Step 25 for head (47).
28. Install coupling (46).

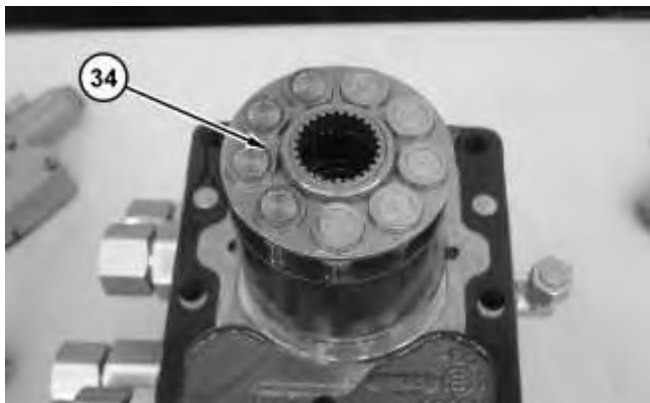

Illustration 16

g01325564

29. Repeat Steps 16 through Steps 22 for barrel assembly (34).

30. Install barrel assembly (34).

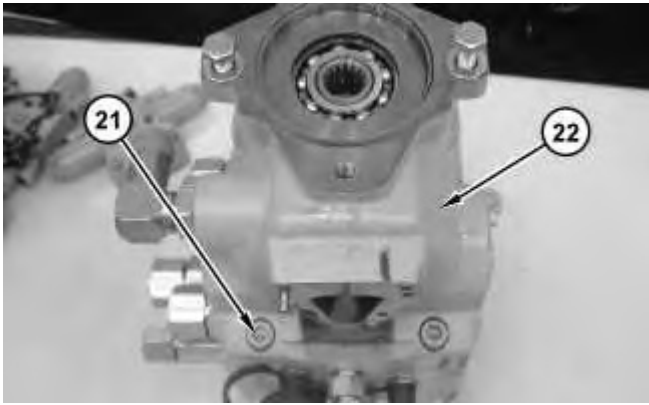

Illustration 17

g01325541

31. Install housing (22) and bolts (21). Tighten bolts (21) to a torque of 110 ± 10 N·m (81 ± 7 lb ft).

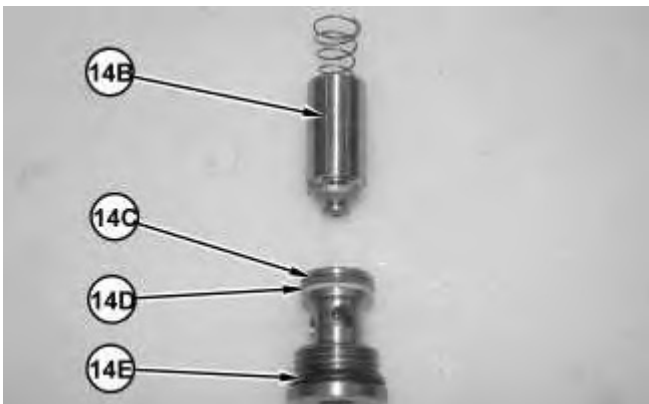

Illustration 18

g01377507

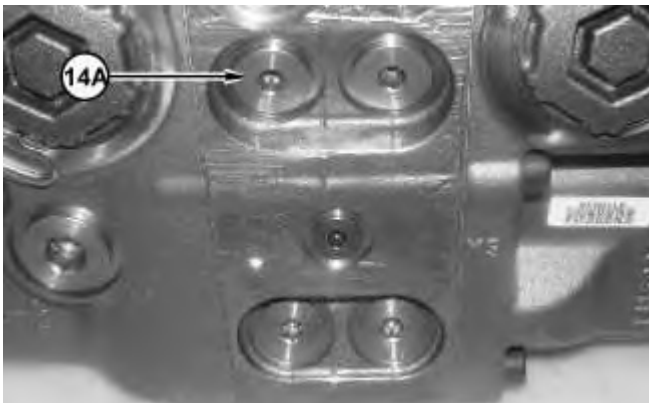

Illustration 19

g01377504

32. Install crossover relief valves (14B), backup ring (14D), O-ring seal (14C), O-ring seal (14E) and plugs (14A) into the head.

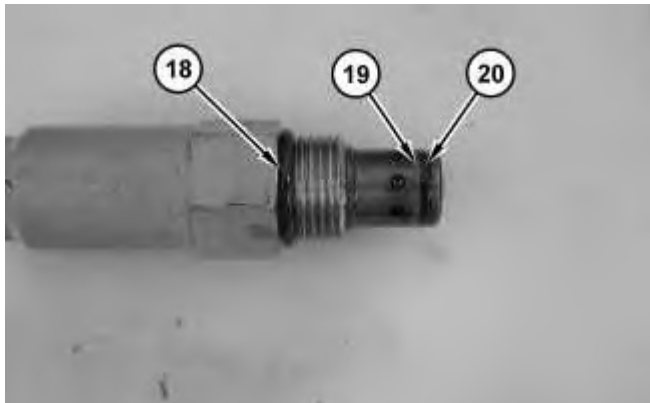

Illustration 20

g01325540

33. Install O-ring seal (20), backup ring (19), and O-ring seal (18).

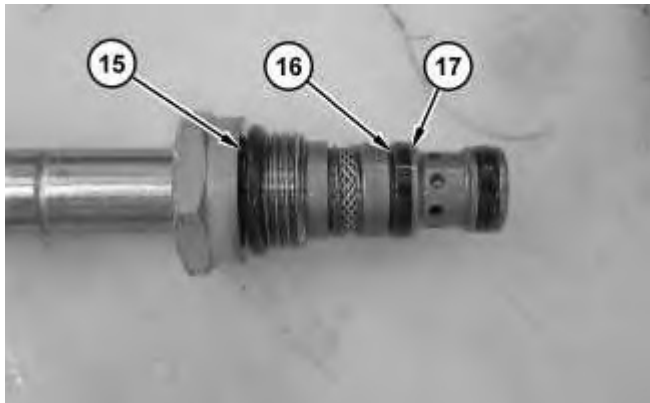

Illustration 21

g01325538

34. Install O-ring seals (17), backup rings (16), and O-ring seal (15).

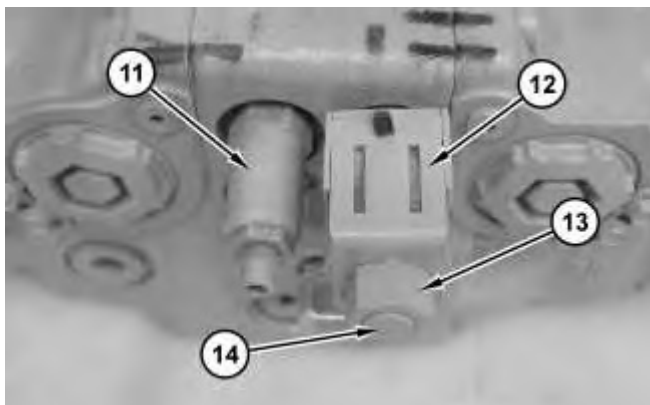

Illustration 22

g01325536

35. Install valve (11). Tighten valve (11) to a torque of 44 ± 3 N·m (32 ± 2 lb ft).

36. Install cartridge (14), coil (12), and nut (13). Tighten nut (13) to a torque of $80 \pm 10 \text{ N}\cdot\text{m}$ ($59 \pm 7 \text{ lb ft}$).
37. Install the cross over relief valves and the plugs into the head. Tighten plugs (21) to a torque of $110 \pm 10 \text{ N}\cdot\text{m}$ ($81 \pm 7 \text{ lb ft}$).

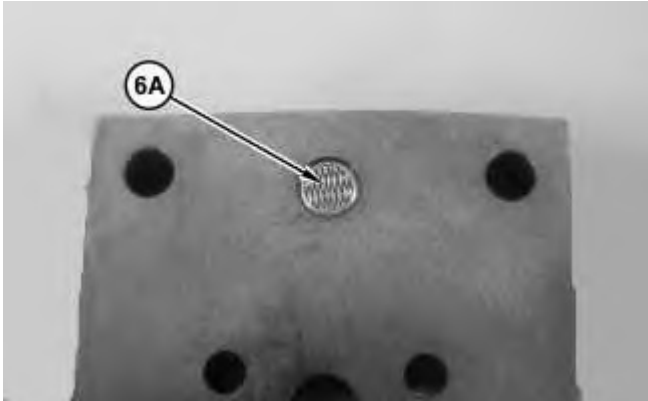

Illustration 23

g01377500

38. Install screen (6A).

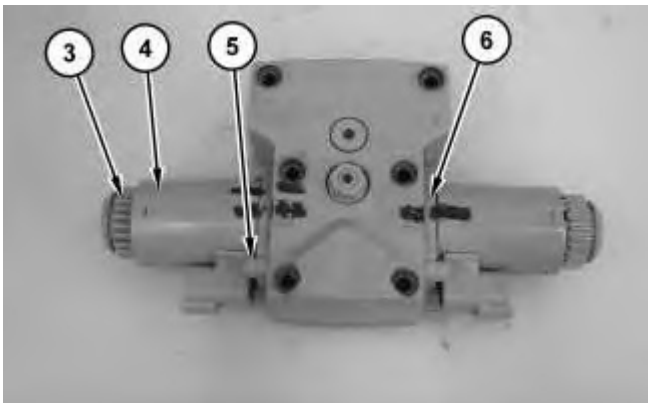
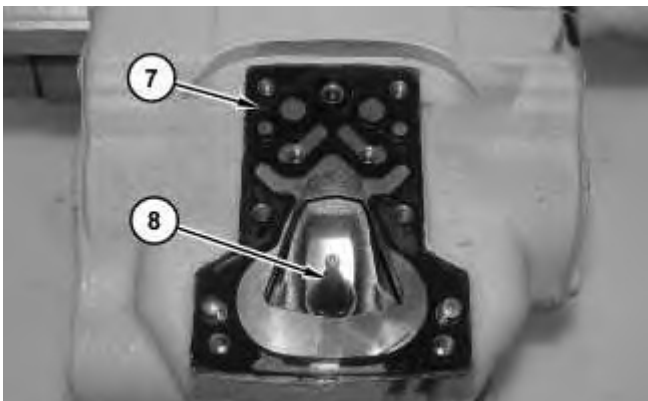

Illustration 24

g01325526

39. Install cartridge (6), bolts (5), coil (4), the O-ring seal, and nut (3). Tighten bolts (5) to a torque of $5.5 \pm 0.1 \text{ N}\cdot\text{m}$ ($49 \pm 0.9 \text{ lb in}$).



40. Install control arm (8) and gasket (7).
41. Apply Tooling (E) to control arm (8).

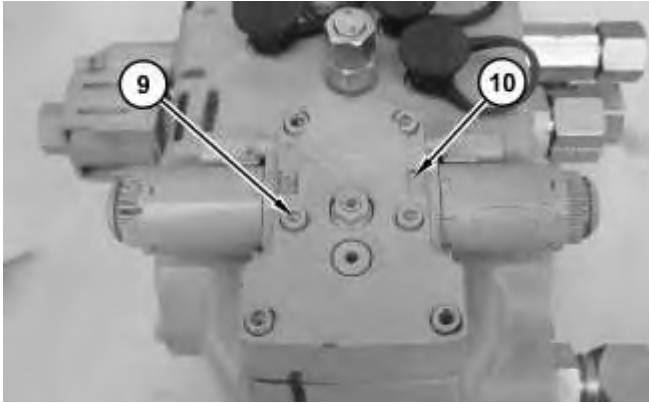

Illustration 26

g01325534

42. Install valve (10) and bolts (9). Tighten bolts (9) to a torque of 13 ± 1 N·m (115 ± 9 lb in).

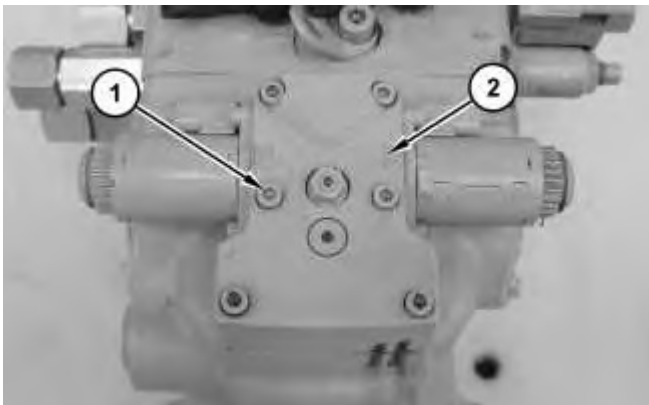

Illustration 27

g01325524

43. Repeat Steps 39 through Steps 40 for valve (2).
44. Install bolts (1) and valve (2). Tighten bolts (1) to a torque of 13 ± 1 N·m (115 ± 9 lb in).
45. Bench test the pump before installation into the machine.

End By:

- a. Install the piston pump (vibratory).
-



Suggest:

For more complete manuals. Please go to the home page.

<https://www.ebooklibonline.com>

If the above button click is invalid. Please download this document first, and then click the above link to download the complete manual.

Thank you so much for reading

Product: VIBRATORY COMPACTOR

Model: CB-54B VIBRATORY COMPACTOR RJN

Configuration: CB44B and CB54B Asphalt Compactor RJN00001-UP (MACHINE) POWERED BY C4.4 Engine

Disassembly and Assembly CB54B Vibratory Asphalt Compactor Machine Systems

Media Number -UENR3258-08

Publication Date -01/12/2014

Date Updated -29/11/2017

i04891435

Piston Pump (Vibratory) - Assemble - Split Drum

SMCS - 5070-016; 5652-016

Assembly Procedure

Table 1

Required Tools			
Tool	Part Number	Part Description	Qty
A	1P-1861	Retaining Ring Pliers	1
C	1P-0510	Driver Gp	1
D	1P-1864	Retaining Ring Pliers As	1



Illustration 1

g03025958

1. Install seal (52) and guide rings (53).



Illustration 2

g03025956

2. Position cover (51) and install bolts (50).

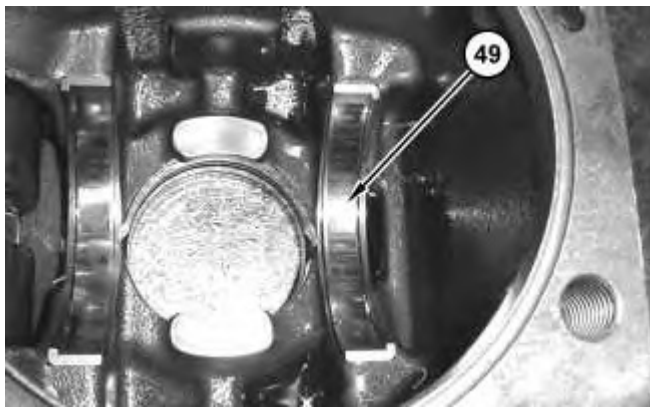

Illustration 3

g03025945

3. Install bearing races (49).

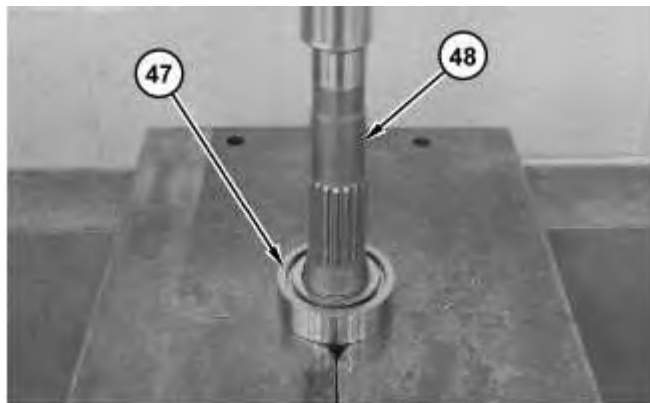

Illustration 4

g03025941

4. Raise the temperature of bearing (47).
5. Install bearing (47) onto shaft (48).

<https://www.ebooklibonline.com>

Hello dear friend!

Thank you very much for reading.

Enter the link into your browser.

The full manual is available for immediate download.

<https://www.ebooklibonline.com>