

Date: 2013/10/20	Image id: 1006590	Catalogue: 20024	Model: MC70
Brand: Volvo	Serial: 60000-61000	Group/Section: 218/100	Title: Engine mounting

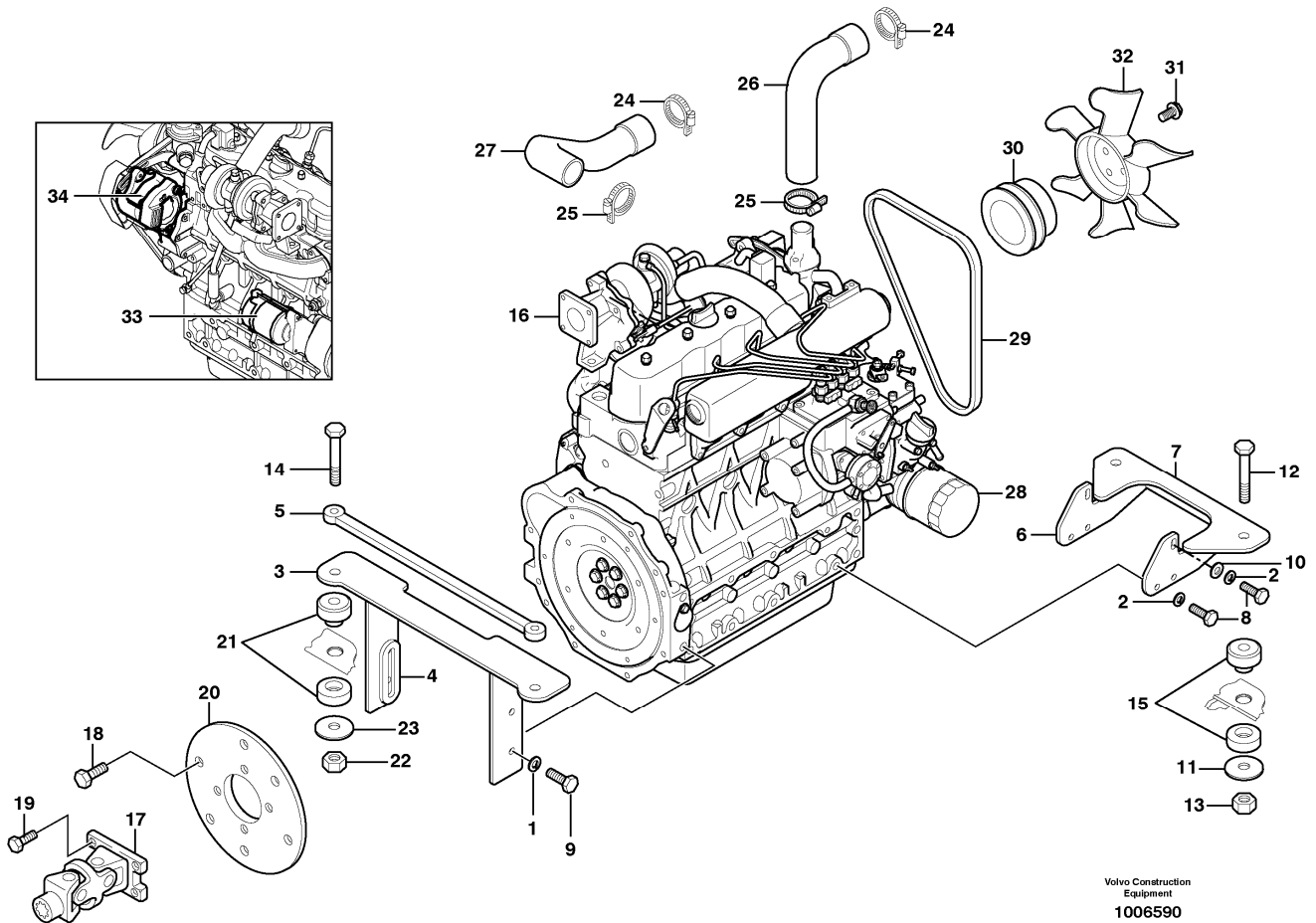

Pos	Part	Q1	Q2	Q3	Q4	Q5	PS	Kit	Description	Option(s)	Remark
1	VOE955925	4							Washer		
2	VOE955924	6							Spring washer		
3	VOE11850029	1					NS		Mounting Plate		
4	VOE11840897	2					OP		•Spacer		
5	VOE11850248	2					OP		•Spacer		
6	VOE11841147	1					NS		Mounting Plate		
7	VOE11840916	1					OP		•Flat bar		
8	VOE962772	6							Hexagon screw		
9	VOE962797	4							Hexagon screw		
10	VOE11841560	2							Washer		
11	VOE11840981	4							Washer		
12	VOE955598	2							Hexagon screw		
13	VOE11841453	4							Hexagon nut		
14	VOE959826	2					OP		Hexagon screw		



Suggest:

For more complete manuals. Please go to the home page.

<https://www.ebooklibonline.com>

If the above button click is invalid. Please download this document first, and then click the above link to download the complete manual.

Thank you so much for reading

15	VOE11841316	4							Rubber cushion		
16	VOE11840890	1							Engine		
17	VOE11840942	1							Ball joint		
18	VOE963896	6							Hexagon screw		
19	VOE955691	4							Hexagon screw		
20	VOE11841004	1					NS		Plate		
21	VOE11841316	4							Rubber cushion		
22	VOE11841453	4							Hexagon nut		
23	VOE11840981	4							Washer		
24	VOE943478	2							Hose clamp		
25	VOE943477	2							Hose clamp		
26	VOE11841007	1							Hose		
27	VOE11841009	1							Hose		
28	VOE11711396	1							Oil filter		
29	VOE11711478	1							V-belt		
30	VOE11711480	1							Pulley		
31	VOE11711483	4							Screw		
32	VOE11711481	1							Fan		
33	VOE11711475	1							Starter motor		
34	VOE11711484	1							Alternator		

<https://www.ebooklibonline.com>

Hello dear friend!

Thank you very much for reading.

Enter the link into your browser.

The full manual is available for immediate download.

<https://www.ebooklibonline.com>

<https://www.ebooklibonline.com>

Hello dear friend!

Thank you very much for reading.

Enter the link into your browser.

The full manual is available for immediate download.

<https://www.ebooklibonline.com>