

TB25FR

Compact Excavator

SERIAL No.12810001~

BOOK No. AE4E000

OPERATOR'S MANUAL

 **WARNING**

Read and understand these instructions.
Failure to do so can cause injury or death.

TAKEUCHI



SAFETY ALERT SYMBOL

This symbol means Attention! Be Alert! Your Safety Is Involved. The message that follows the symbol contains important information about safety.

Read and understand the message to avoid personal injury or death.

- **It is the owner or employer's responsibility to fully instruct each operator in the proper and safe operation of all equipment. All persons using this machine should thoroughly familiarize themselves with the following sections.**
- **All operators must be instructed on the proper functions of the excavator before running the machine.**
- **Learn and practice correct use of the machine controls in a safe, clear area before operating this machine on a job site.**

 CAUTION	
 <small>E3A010</small>	Improper operation, inspection and maintenance of this machine can cause injury or death. Read and understand this manual before performing any operation, inspection or maintenance on this machine.



- **Always store this manual near at hand preferably on the machine itself. If it should be lost or damaged, immediately order a new one from your Takeuchi dealer. When transferring ownership of this machine, be sure to provide this manual to the next owner.**
- **Takeuchi supplies machines complying to the local regulations and standards of the country of export. If your machine has been purchased in another country or from a person or company of another country, it may not have the safety devices or safety standards required for use in your country. Should you have any question about whether your machine complies with the regulations and standards of your country, contact a Takeuchi dealer.**
- **Please note that the contents and diagrams included in this manual may not match your machine exactly.**



It is your responsibility to observe all pertinent laws and regulations and to follow the manufacturer’s instructions on machine operation, inspection and maintenance.

Virtually all accidents occur as the result of a failure to observe basic safety rules and precautions. An accident can often be avoided by recognizing potentially hazardous situations beforehand. Read and understand all of the safety messages which explain how to prevent these accidents from occurring. Do not operate the machine until you are sure that you have gained a proper understanding of its operation, inspection and maintenance.

■ SIGNAL WORDS

Safety messages appearing in this manual and on machine decals are identified by the words “DANGER”, “WARNING” and “CAUTION”. These signal words mean the following:

 DANGER	 WARNING	 CAUTION
The word “DANGER” indicates an imminently hazardous situation which, if not avoided, can result in serious injury or death.	The word “WARNING” indicates a potentially hazardous situation which, if not avoided, could result in serious injury or death.	The word “CAUTION” indicates a potentially hazardous situation which, if not avoided, may result in minor or moderate injury.

 The  mark on illustrations indicates prohibited or dangerous actions.

IMPORTANT: The word “IMPORTANT” is used to alert against operators and maintenance personnel about situations which can result in possible damage to the machine and its components.

It is impossible to foresee every possible circumstance that might involve a potential hazard. The warnings in this manual or on the machine can not cover all possible contingencies. You must exercise all due care and follow normal safety procedures when operating the machine so as to ensure that no damage occurs to the machine, its operators or other persons.

<https://www.ebooklibonline.com>

Hello dear friend!

Thank you very much for reading.

Enter the link into your browser.

The full manual is available for immediate download.

<https://www.ebooklibonline.com>

INTRODUCTION

Foreword

This manual describes operation, inspection and maintenance of the machine, as well as safety instructions to be heeded during these operations.

If you have any questions about the machine, please contact a Takeuchi sales or service outlet.

■ Manual storage compartment

A compartment for storing this manual is provided at the position shown on the diagram below.

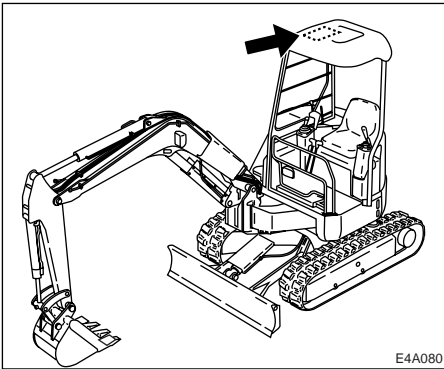

■ Serial numbers

Check the serial numbers of the machine and the engine and write them in the spaces provided below.

Machine number :

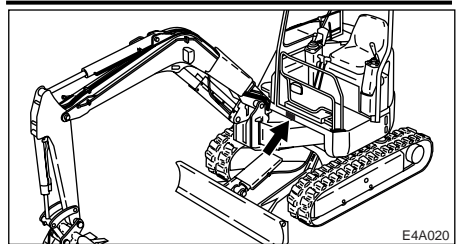

Engine number :

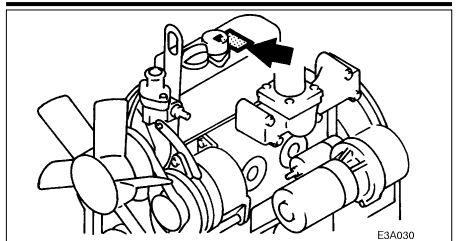

MACHINE DESCRIPTION

■ Front, rear, left and right

This manual refers the front, rear, left and right of the machine as seen when sitting in the operator's seat with the dozer blade visible to the front.

■ Designated operations

Use this machine primarily for the following operations:

- Excavating
- Digging ditches
- Digging side ditches
- Leveling
- Loading

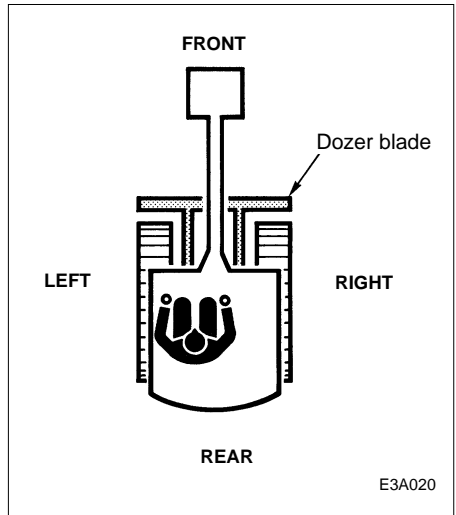

■ Features

- Short tail swing radius
- Smaller slewing by offsetting the boom to the right
- Fast working speed and low-shock working equipment
- Excellent stability thanks to a low center of gravity
- Simple replacement of rubber and steel crawler belts









■ Break-in period

When the machine is new, heed the instructions below when operating the machine for the first 100 hours (as indicated on the hour meter).

Using a new machine roughly without breaking it in will lead to quicker deterioration of machine performance and may shorten the machine's service life.

- Warm up the engine and hydraulic oil sufficiently.
- Avoid heavy loads and rapid operations. Operate with a load of about 80% the maximum load.
- Do not start up, accelerate, change directions, or stop abruptly (unless necessary)..

Contents

Introduction	2
Machine Description	3
 Safety	7
 Controls	35
 Operation	49
 Transport	79
 Maintenance	83
 Troubleshooting	127
 Specifications	137
 Options	145
 Index	155



SAFETY

General precautions	8
Preparing precautions	12
Starting precautions	14
Operating precautions	16
Stopping precautions	23
Transporting precautions	24
Maintenance precautions	25
Safety signs (Decals)	32



SAFETY

General Precautions

Observe all safety rules

- Operation, inspection and maintenance of this machine must be performed only by a trained and qualified person.
- All rules, regulations, precautions and safety procedures must be understood and followed when performing operation, inspection and maintenance of this machine.
- Do not perform any operation, inspection and maintenance of this machine when under the adverse influence of alcohol, drugs, medication, fatigue, or insufficient sleep.

Wear appropriate clothing and personal protective equipment

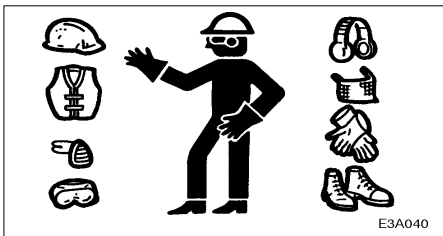

- Do not wear loose clothing or any accessory that can catch on controls or in moving parts.
- Do not wear oily or fuel stained clothing that can catch fire.
- Wear a hard hat, safety shoes, safety glasses, filter mask, heavy gloves, ear protection and other protective equipment as required by job conditions. Wear required appropriate equipment such as safety glasses and filter mask when using grinders, hammers or compressed air, as metal fragments or other objects can fly and cause serious personal injury.

- Use hearing protection when operating the machine. Loud prolonged noise can cause hearing impairments, even the total loss of hearing.

Provide a fire extinguisher and first aid kit

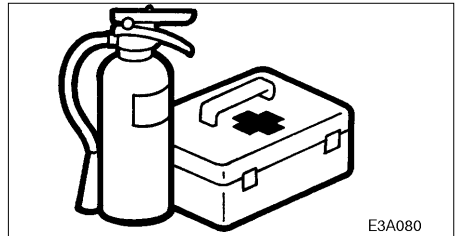

- Know where a fire extinguisher and first aid kit are located and understand how to use them.
- Know how to contact emergency assistance and first aid help.

Never remove safety equipment

- Make sure all protective guards, canopies, doors, etc., are in place and secure. Repair or replace damaged components before operating the machine.

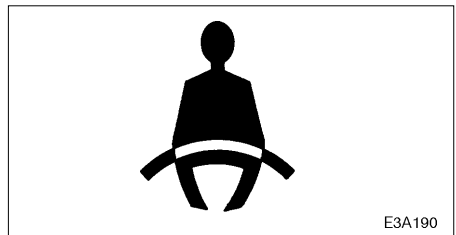

- Know how to use the safety lock lever, seat belt and other safety equipment and use them properly.
- Never remove any safety equipment except for service. Keep all safety equipment in good operating condition.

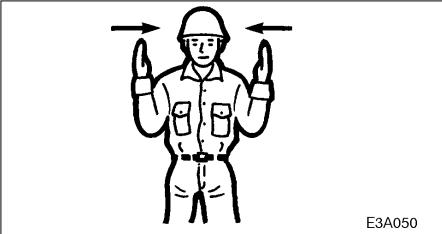
**Use a signal person and flagman**

Know and use the hand signals required for particular jobs and make sure who has the responsibility for signaling.

- All personnel must fully understand all the signals.
- The operator shall respond to signals only from the appointed signal person, but shall obey a stop signal at any time from anyone.
- The signal person must stand in a clearly visible location when giving signals.

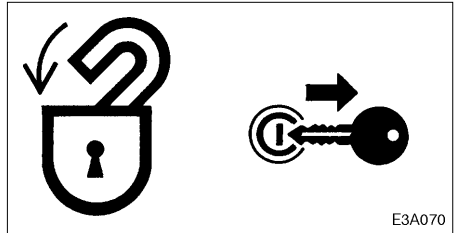
Be sure to lock the safety lock lever before leaving the operator's seat

- Before leaving the operator's seat, set the safety lock lever securely to the lock position and stop the engine. If any controls should be touched accidentally when the safety lock lever has not be locked, the machine will move suddenly, and cause severe injury or death.
- Note that the auxiliary hydraulics controls are not locked, even when the safety lock lever is set to the lock position. Do not touch these controls accidentally.
- Before leaving the operator's seat, lower the working equipment, lock the safety lock lever, and stop the engine. Also, be sure to remove the key and take it with you.



SAFETY

General Precautions

Avoid fire and explosion hazards



Keep flames away from fuel, hydraulic fluid, oil, grease and antifreeze. Fuel is particularly flammable and dangerous.

- When handling these combustible materials, keep lit cigarettes, matches, lighters and other flames or sources of flames away. • Do not smoke or permit open flames while fueling or near fueling operations.
- Never remove the fuel cap or refuel with the engine running or hot. Never allow fuel to spill on hot machine components.
- Clean up spilled fuel, oil or other flammable fluids immediately.
- Check for fuel, oil or hydraulic fluid leaks. Stop all leaks and clean the machine before operating.
- Do not cut or weld on pipes or tubes that contain flammable fluids. Clean thoroughly with nonflammable solvent before cutting or welding.
- Remove all trash or debris from the machine. Make sure that oily rags or other flammable material are not stored on the machine.
- Handle all solvents and dry chemicals according to procedures identified on manufacturers' containers. Work in a well-ventilated area.
- Never use fuel for cleaning purposes. Always use a nonflammable solvent.
- Store all flammable fluids and materials in a safe and well-ventilated place.

Exhaust fumes from the engine can kill



- Do not operate the engine in an enclosed area without adequate ventilation.
- If natural ventilation is poor, install ventilators, fans, exhaust extension pipes or other artificial venting devices.

Handling asbestos dust

Inhaling asbestos dust has been linked to lung cancer. When handling materials which may contain asbestos, take the following precautions:

- Never use compressed air for cleaning.
- Avoid brushing or grinding of the materials.
- For clean up, use wet methods or a vacuum equipped with a high efficiency particulate air (HEPA) filter.
- Wear an approved respirator if there is no other way to control the dust. When working indoors, install a ventilation system with a macro molecular filter.



SAFETY

General Precautions

Be careful not to get crushed or cut



Never put your hands, feet or other parts of your body between the upperstructure and the undercarriage or tracks, between the machine body and working equipment, or between a cylinder and moving part. The size of these gaps change when the machine moves and if caught a person can suffer severe injury or death.

Never modify machine

Unauthorized modifications to this machine can cause injury or death. Never make unauthorized modifications to any part of this machine.

Using optional products

- Consult with a Takeuchi dealer before installing optional attachments.
- Do not use attachments that have not been approved by Takeuchi or a Takeuchi dealer. Doing so may compromise safety or adversely affect the machine's operation or service life.
- Takeuchi will not be held responsible for any injuries, accidents or damage to its products caused by the use of a non-approved attachment.



Know the working area

Before starting operation, know the working area to ensure safety.

- Check the topography and ground condition of the working area, or the structure of the building when working indoors, and take the necessary safety measures in dangerous spots.
- Note and avoid all hazards and obstructions such as ditches, underground lines, trees, cliffs, overhead electrical wires or areas where there is danger of a slide.

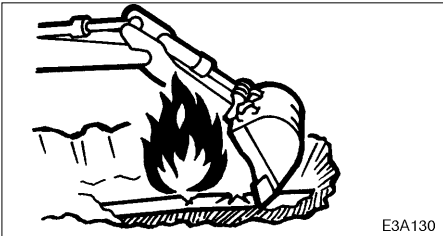

- Check with the local utilities for the locations of buried gas and water pipes and buried power cables. Determine jointly what specific precautions must be taken to insure safety.
- When working on roads, be sure to take into account the safety of pedestrians and vehicles.
 - Use a flagman an/or signals.
 - Fence off the working area and prohibit entry to unauthorized persons.
- When working in water or crossing shallow streams or creeks, check the depth of the water, the solidity of the ground, and the speed of the current beforehand. Make sure the water is not deeper than the allowable depth.

Refer to the section titled Precautions During Operations for further instructions.

Always keep the machine clean



- Clean windows, mirrors and lights to ensure good visibility.
- Wipe off any oil, grease, mud, snow or ice, to prevent accidents due to slipping.
- Remove all loose objects stored in the machine and all objects which do not belong in or on the machine and its equipment.
- Remove any dirt, oil or grease from the engine area, to prevent fires.
- Clean the area around the operator's seat, removing any potential obstacles.



SAFETY

Preparing Precautions

Perform inspection and maintenance daily

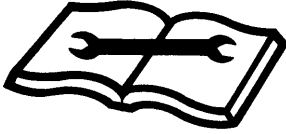

E3A520

Failure to notice or repair machine irregularities or damage can lead to accidents.

- Before operating, perform the prescribed inspections and make repairs immediately should any irregularities be found.
- If a failure that causes loss of control such as steering, service brakes or engine occurs, stop the machine motion as quickly as possible, follow the shutdown procedure, and keep machine securely parked until the malfunction is corrected.

**Maintain three point contact when mounting and dismounting**

- Do not jump on or off the machine. Never attempt to mount or dismount a moving machine.
- When mounting and dismounting the cab, first open the door fully to the locked position and check that it does not move. (For machines with cabs)



- Always face the access system and maintain a three point body contact with the recommended hand holds and steps while getting on and off the machine. Keep steps and platform clean.
- Never use the safety lock lever or control levers as hand holds.

Clear the area of other persons before starting the machine

Do not start the engine until you are sure it is safe. Before starting, check or perform the following.

- Walk around the machine and warn all personnel who may be servicing the machine or are in the machine path. Do not start until all personnel are clearly away from the machine.

- Check for any “DO NOT OPERATE” tags or similar warning notices on the cab door, controls or starter switch.
- Sound horn to alert everyone around the machine.

Start the engine from the operator's seat

- Adjust, secure and latch the operator's seat.

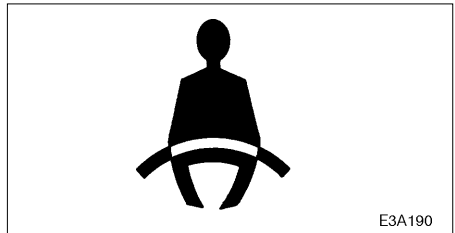

- Fasten the seat belt.
- Check that the parking device is applied and place all controls in the neutral position.
- Check that the safety lock lever is in the lock position.
- Clear the area of all persons.
- Start and operate the engine from the operator's seat only.
- Never attempt to start the engine by shorting across the starter terminals.



Suggest:

For more complete manuals. Please go to the home page.

<https://www.ebooklibonline.com>

If the above button click is invalid. Please download this document first, and then click the above link to download the complete manual.

Thank you so much for reading

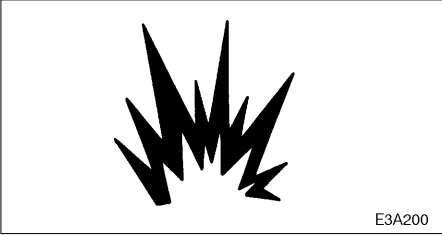
**Starting with jumper cables**

Use jumper cables only in the recommended manner. Improper use of jumper cables can result in battery explosion or unexpected machine motion.

Refer to the section titled If the Battery Goes Dead for proper instructions.

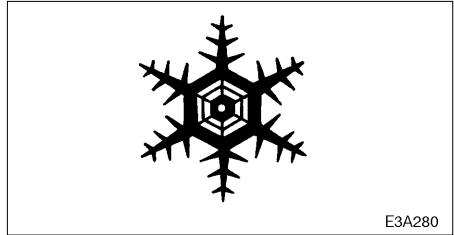
In cold weather

- Be careful of slippery conditions on freezing ground, steps and hand holds.
- In severe cold weather, do not touch any metal parts of the machine with exposed flesh, as flesh can freeze to the metal and Cause injury.
- Do not use ether or starting fluids on this engine. These starting aids can cause explosion and serious injury or death.
- Warm up the engine and hydraulic fluid before operating.

After starting the engine

After starting the engine, perform the following operations and checks in a safe place with no persons or obstacles in the area. If any malfunctions are found, follow the shutdown procedure and report the malfunction.

- Warm up the engine and hydraulic fluid.
- Observe all gauges or warning instruments for proper operation.
- Listen for unusual noises.
- Test engine speed control.
- Operate each control to insure proper operation.

**Ensure good visibility**

- When working in dark places, turn on the machine's working lights and headlights and/or provide extra stationary lighting if necessary.
- When visibility is poor due to severe weather (fog, snow or rain), stop operating the machine and wait until conditions improves.

Do not permit riders on the machine

- Do not allow anyone to ride on any part of the machine at any time while traveling.
- Do not allow anyone to be on any part of the machine while operating.

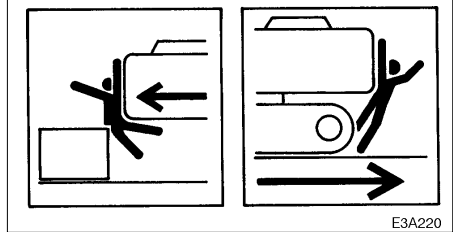
Check for safety in the surrounding area before starting

- Understand the machine limitations.
- Use a signal person where clearances are close or your vision is obstructed.
- Never allow anyone to enter the slewing (swing) radius and machine path.
- Signal your intention to move by sounding the horn.
- There are blind spots to the rear of the machine.

If necessary, swing the cab around before backing up to check that the area is safe and clear.

<https://www.ebooklibonline.com>

Hello dear friend!

Thank you very much for reading.

Enter the link into your browser.

The full manual is available for immediate download.

<https://www.ebooklibonline.com>