

JOHN DEERE
AG & TURF DIVISION

ZTrak™
Z900B, Z900M, Z900R Series

OMTCU33448 K2
OPERATOR'S MANUAL



JOHN DEERE

⚠ WARNING: The Engine Exhaust from this product contains chemicals known to the State of California to cause cancer, birth defects or other reproductive harm.

California Proposition 65 Warning

North American Version
Printed in U.S.A.

Introduction

Thank You for Purchasing a John Deere Product

We appreciate having you as a customer and wish you many years of safe and satisfied use of your machine.

Using Your Operator's Manual

This manual is an important part of your machine and should remain with the machine when you sell it.

Reading your operator's manual will help you and others avoid personal injury or damage to the machine. Information given in this manual will provide the operator with the safest and most effective use of the machine. Knowing how to operate this machine safely and correctly will allow you to train others who may operate this machine.

If you have an attachment, use the safety and operating information in the attachment operator's manual along with the machine operator's manual to operate the attachment safely and correctly.

This manual and safety signs on your machine may also be available in other languages (see your authorized dealer to order).

Sections in your operator's manual are placed in a specific order to help you understand all the safety messages and learn the controls so you can operate this machine safely. You can also use this manual to answer any specific operating or servicing questions. A convenient index located at the end of this book will help you to find needed information quickly.

The machine shown in this manual may differ slightly from your machine, but will be similar enough to help you understand our instructions.

RIGHT-HAND and LEFT-HAND sides are determined by facing in the direction the machine will travel when going forward. When you see a broken line (-----), the item referred to is hidden from view.

Before delivering this machine, your dealer performed a predelivery inspection to ensure best performance.

Special Messages

Your manual contains special messages to bring attention to potential safety concerns, machine damage as well as helpful operating and servicing information. Please read all the information carefully to avoid injury and machine damage.



CAUTION: Avoid injury! This symbol and text highlight potential hazards or death to the operator or bystanders that may occur if the hazards or procedures are ignored.

IMPORTANT: Avoid damage! This text is used to tell the operator of actions or conditions that might result in damage to the machine.

NOTE: General information is given throughout the manual that may help the operator in the operation or service of the machine.

Product Identification

Record Identification Numbers

ZTrak™ Z915B (Z900B Series), Z920M, Z925M EFI, Z930M, Z930M EFI (Z900M Series), Z920R, Z930R, Z950R, Z960R, Z970R (Z900R Series)

PIN (010001-)

If you need to contact an Authorized Service Center for information on servicing, always provide the product model and serial number.

You will need to locate the model and serial number for the machine and for the engine of your machine and record the information in the spaces provided below.

DATE OF PURCHASE:

DEALER NAME:

DEALER PHONE:

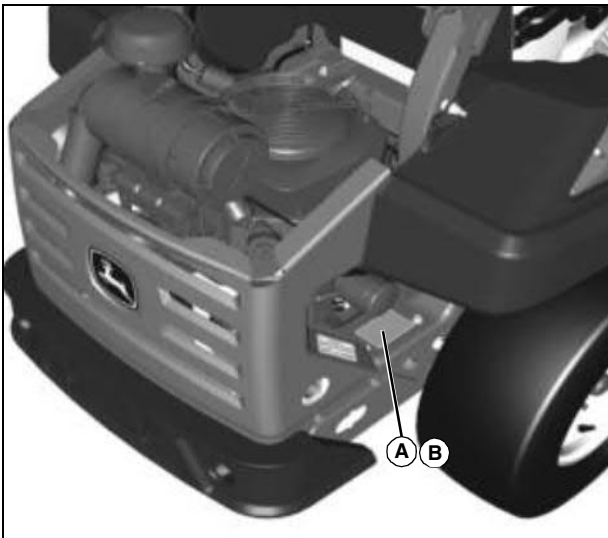

MX51851

PRODUCT MODEL NUMBER (A):

PRODUCT IDENTIFICATION NUMBER (B):

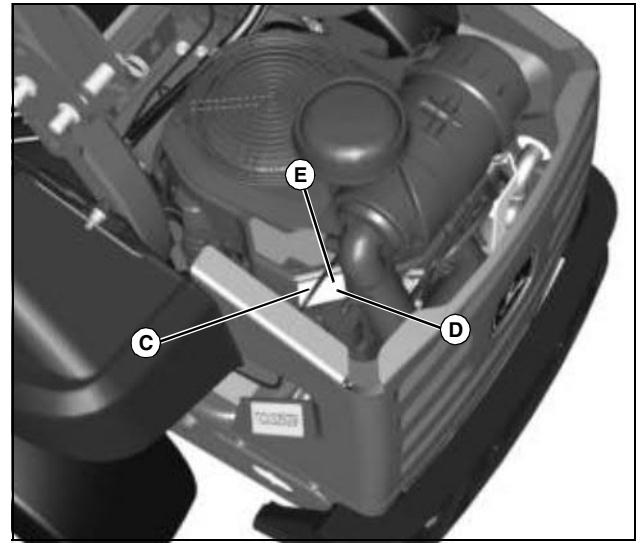

MX51852

Picture Note: Kohler Engine

ENGINE MODEL NUMBER (C):

ENGINE SPECIFICATION NUMBER (D):

ENGINE SERIAL NUMBER (E):

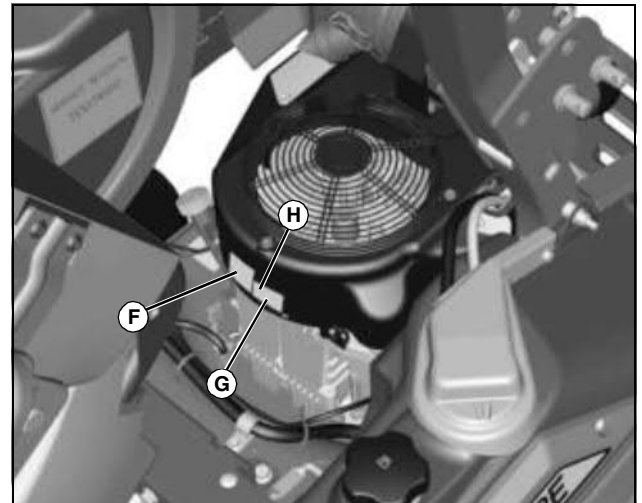

MX51909

Picture Note: Kawasaki Engine

ENGINE MODEL NUMBER (F):

ENGINE SPECIFICATION NUMBER (G):

ENGINE SERIAL NUMBER (H):

<https://www.ebooklibonline.com>

Hello dear friend!

Thank you very much for reading.

Enter the link into your browser.

The full manual is available for immediate download.

<https://www.ebooklibonline.com>

Table of Contents

Safety Labels	1
Safety Labels	6
Safety	11
Operating - Controls	19
Operating	21
Replacement Parts	40
Service Intervals	41
Service Lubrication	43
Service Engine	45
Service Transmission	61
Service Steering & Brakes	67
Service Mower	70
Service Electrical	74
Service Miscellaneous	79
Troubleshooting	83
Storage	95
Specifications	97
Warranty	105
Index	107

Original Instruction

All information, illustrations and specifications in this manual are based on the latest information at the time of publication. The right is reserved to make changes at any time without notice.

COPYRIGHT© 2012

Deere & Co.

John Deere Ag & Turf Division

All rights reserved

Previous Editions

COPYRIGHT©

OMTCU33448 K2 -

Safety Labels

Safety Label Location (Text)

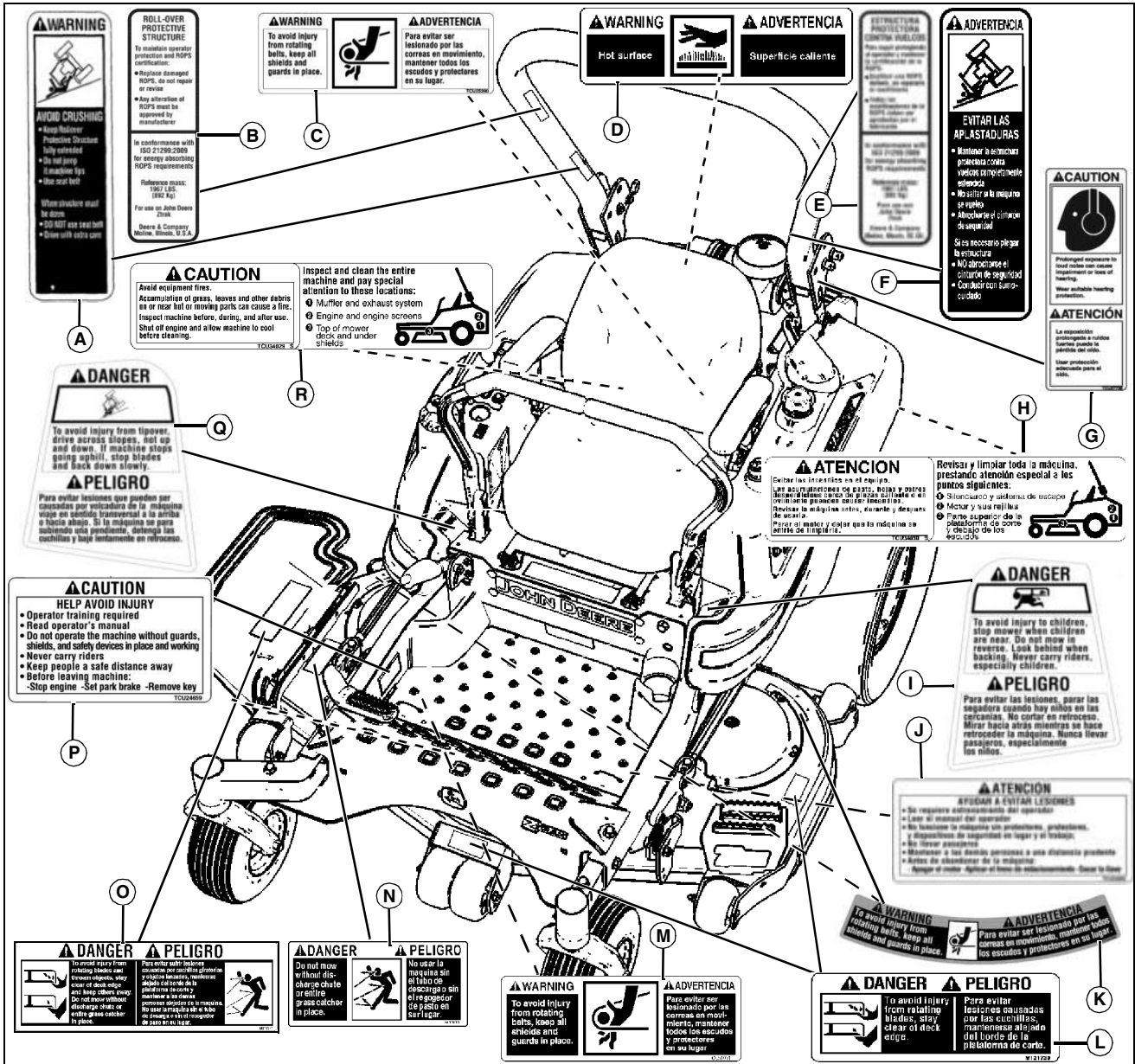

Picture Note: Use label number listed in table below to locate complete text of safety label message following this illustration.

A - AVOID CRUSHING

B - ROLL-OVER PROTECTIVE STRUCTURE

C - ROTATING BELT

D - HOT SURFACES

E - ROLL-OVER PROTECTIVE STRUCTURE (Spanish)

F - AVOID CRUSHING (Spanish)

G - HEARING PROTECTION

H - PREVENT EQUIPMENT FIRES (Spanish)

I - AVOID INJURY TCU31665

J - HELP AVOID INJURY (Spanish)

K - ROTATING BELT

L - ROTATING BLADES

M - ROTATING BELT

N - THROWN OBJECTS

O - ROTATING BLADES AND THROWN OBJECTS

P - HELP AVOID INJURY

Q - AVOID TIPPING

R - PREVENT EQUIPMENT FIRES TCU34029

Safety Labels



Understanding The Machine Safety Labels

The machine safety labels shown in this section are placed in important areas on your machine to draw attention to potential safety hazards.

On your machine safety labels, the words DANGER, WARNING, and CAUTION are used with this safety-alert symbol. DANGER identifies the most serious hazards.

The operator's manual also explains any potential safety hazards whenever necessary in special safety messages that are identified with the word, CAUTION, and the safety-alert symbol.

AVOID CRUSHING



TCU13514

- Keep Rollover Protective Structure fully extended
- Do not jump if machine tips
- Use seat belt

When structure must be down

- DO NOT use seat belt
- Drive with extra care

Roll-Over Protective Structure

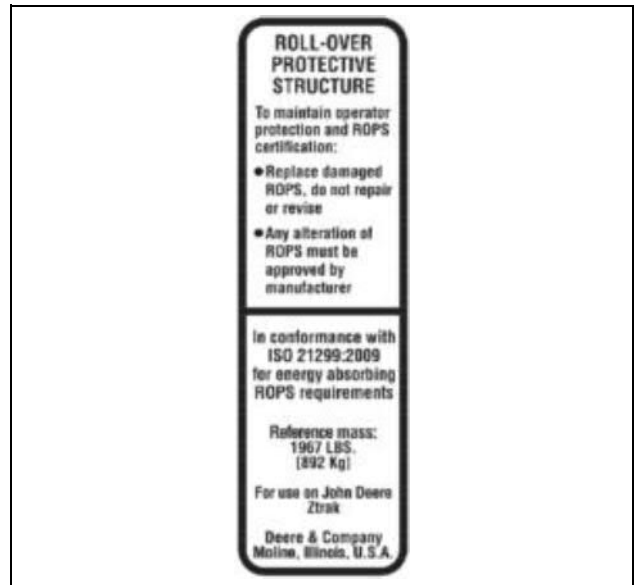

TCU27892

To maintain operator protection and ROPS certification:

- Replace damaged ROPS, do not repair or revise
- Any alteration of ROPS must be approved by manufacturer

In conformance with ISO 21299:2009 for energy absorbing ROPS requirements

- Reference mass: 1967 LBS. [892Kg]
- For use on John Deere Ztrak
- Deere & Company Moline, Illinois, U.S.A.

Rotating Belts



TCU25390

- To avoid injury from rotating belts, keep all shields and guards in place.

Safety Labels

Hot Surface

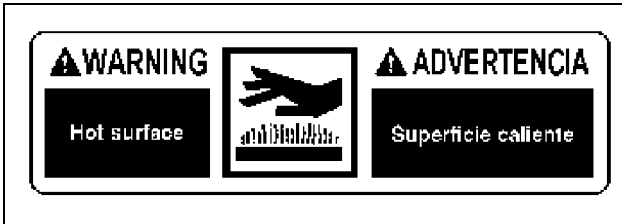

M134406

Hot surface.

Hearing Protection



TCU27738

- Prolonged exposure to loud noise can cause impairment or loss of hearing.
- Wear suitable hearing protection.

Avoid Injury



TCU31665

- To avoid injury to children, stop mower when children are

near. Do not mow in reverse. Look behind when backing. Never carry riders, especially children.

Rotating Belts



TCU24465

- To avoid injury from rotating belts, keep all shields and guards in place.

Rotating Blades

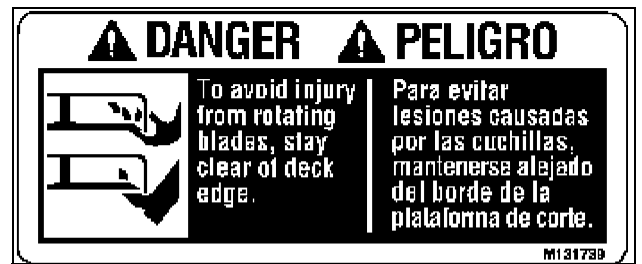

M131739

M131739

- To avoid injury from rotating blades, stay clear of deck edge.

Rotating Belts

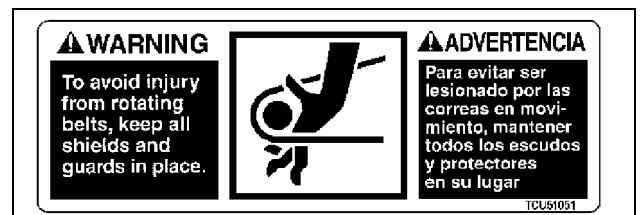

TCU51051

- To avoid injury from rotating belts, keep all shields and guards in place.

Safety Labels

Thrown Objects

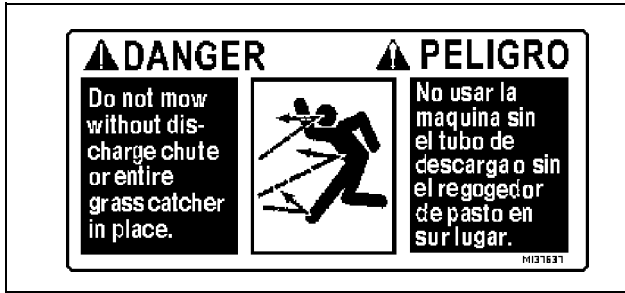

M137637

- Do not mow without discharge chute or entire grass catcher in place.

Rotating Blades and Thrown Objects

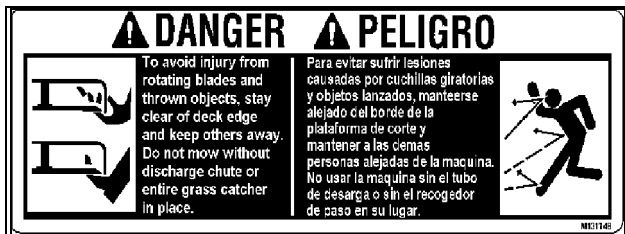

M131748

To avoid injury from rotating blades and thrown objects, stay clear of deck edge and keep others away.

Do not mow without discharge chute or entire grass catcher in place.

HELP AVOID INJURY



TCU24659

- Operator training required
- Read operator's manual
- Do not operate the machine without guards, shields, and safety devices in place and working
- Never carry riders

- Keep people a safe distance away
- Before leaving machine:
 - -Stop engine -Set park brake -Remove key

Avoid Tipping



TCU31666

- To avoid injury from tipover, drive across slopes, not up and down. If machine stops going uphill, stop blades and back down slowly.

Prevent Equipment Fires

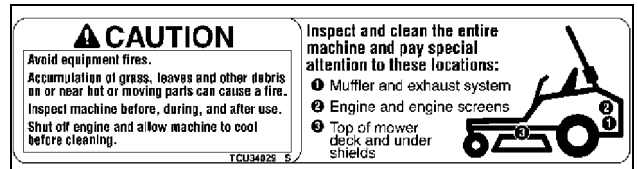

TCU34029

- Avoid equipment fires.
- Accumulation of grass, leaves and other debris on or near hot or moving parts can cause a fire.
- Inspect machine before, during, and after use.
- Shut off engine and allow machine to cool before cleaning.

Inspect and clean the entire machine and pay special attention to these locations:

1. Muffler and exhaust system
2. Engine and engine screens
3. Top of mower deck and under shields

Safety Labels

Certification

Your product has been certified for compliance with American National Standards Institute B-71.4, Safety Specifications for Commercial Turf care Equipment.

Canadian Electromagnetic Compatibility (EMC) Compliance

This spark ignition system complies with Canadian ICES-002.

Safety Labels

Safety Label Location (No Text)

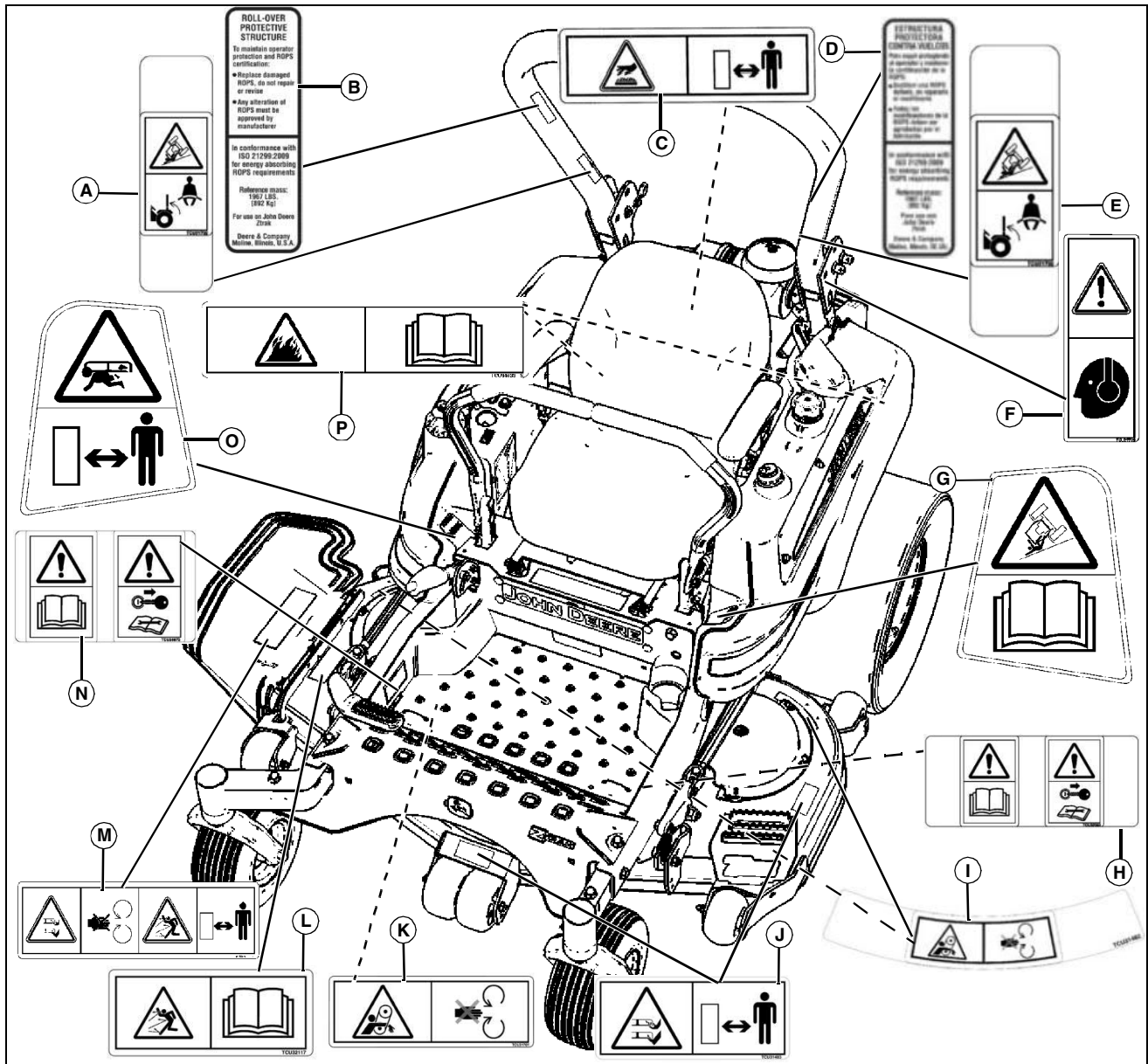

MX52183

Picture Note: Non-text labels are required for certain regions of the world. Your machine may not be equipped with these labels. Use label number listed in table below to locate complete text of safety label message following this illustration.

- | | |
|--|------------------------------------|
| A - AVOID CRUSHING | H - AVOID INJURY |
| B - ROLL-OVER PROTECTIVE STRUCTURE | I - ROTATING BELT |
| C - HOT SURFACES | J - ROTATING BLADES |
| D - ROLL-OVER PROTECTIVE STRUCTURE (Spanish) | K - ROTATING BELT |
| E - AVOID CRUSHING | L - THROWN OBJECTS |
| F - HEARING PROTECTION | M - ROTATING BLADE / THROWN OBJECT |
| G - AVOID TIPPING | N - AVOID INJURY |
| | O - AVOID INJURY |
| | P - PREVENT EQUIPMENT FIRES |

Safety Labels



Understanding The Machine Safety Labels

The machine safety labels shown in this section are placed in important areas on your machine to draw attention to potential safety hazards.

On your machine safety labels, the words DANGER, WARNING, and CAUTION are used with this safety-alert symbol. DANGER identifies the most serious hazards.

The operator's manual also explains any potential safety hazards whenever necessary in special safety messages that are identified with the word, CAUTION, and the safety-alert symbol.

Avoid Crushing



TCU31702

- Keep Rollover Protective Structure fully extended
- Do not jump if machine tips
- Use seat belt

When structure must be down:

- DO NOT use seat belt
- Drive with extra care

Roll-Over Protective Structure

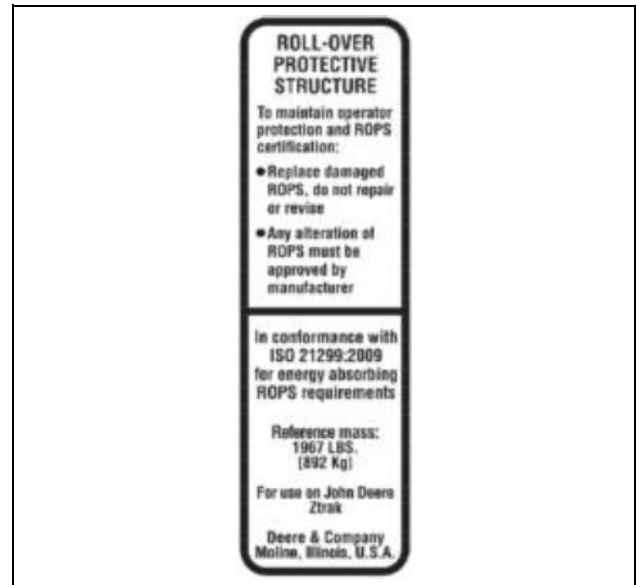

TCU27892

To maintain operator protection and ROPS certification:

- Replace damaged ROPS, do not repair or revise
- Any alteration of ROPS must be approved by manufacturer

In conformance with ISO 21299:2009 for energy absorbing ROPS requirements

- Reference mass: 1967 LBS. [892Kg]
- For use on John Deere Ztrak
- Deere & Company Moline, Illinois, U.S.A.

Hot Surfaces

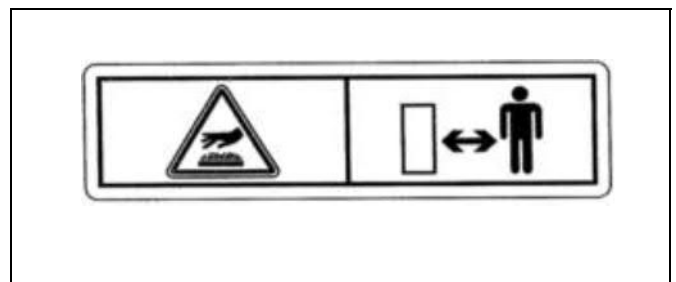

M137684

Hot surface

Safety Labels

Hearing protection

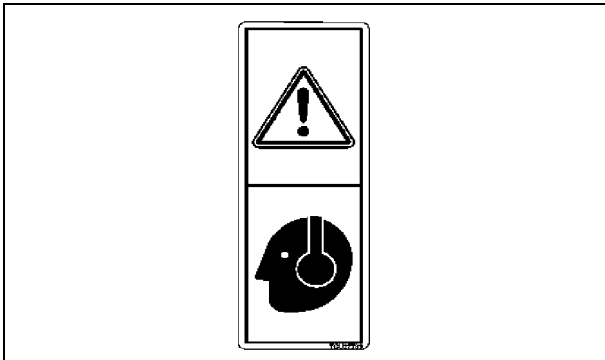

TCU27739

- Prolonged exposure to loud noises can cause impairment or loss of hearing.
- Wear suitable hearing protection.

Avoid Tipping

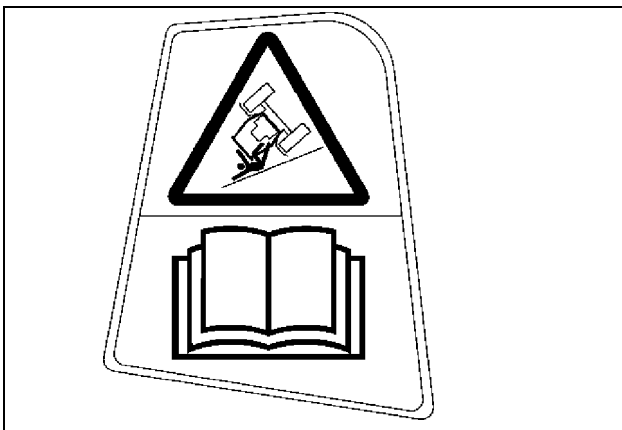

TCU34035

- To avoid injury from tipover, drive across slopes, not up and down. If machine stops going uphill, stop blades and back down slowly.

Avoid Injury



TCU32068

- Operator training required
- Read operator's manual
- Do not operate the machine without guards, shields, and safety devices in place and working
- Never carry riders
- Keep people a safe distance away
- Before leaving machine:
 - Stop engine -Set park brake -Remove key

Rotating Belts

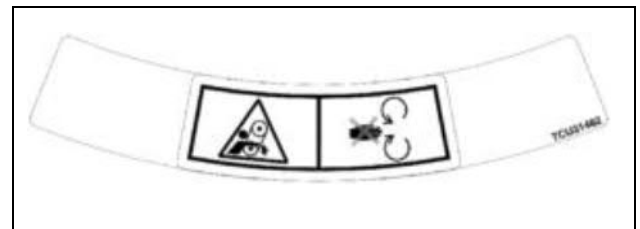

TCU31482

- To avoid injury from rotating belts, keep all shields and guards in place.

Safety Labels

Rotating Blades

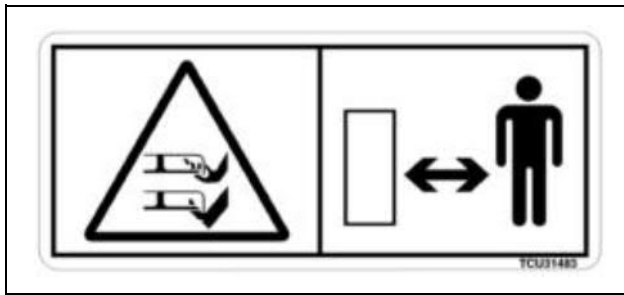

TCU31483

- To avoid injury from rotating blades, stay clear of deck edge.
- Do not mow without discharge chute or entire grass catcher in place.

Rotating Blades / Thrown Objects

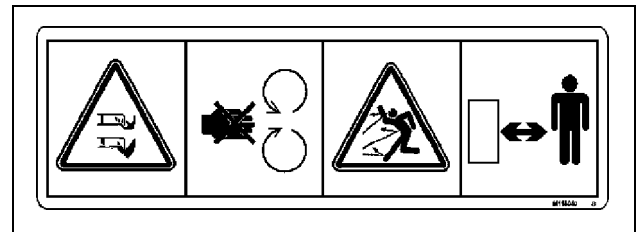

M118040

- Do not put hands or feet under or into mower when engine is running.
- Do not operate mower without discharge chute or entire grass catcher in place.
- Keep away from machine while engine is running.

Rotating Belts

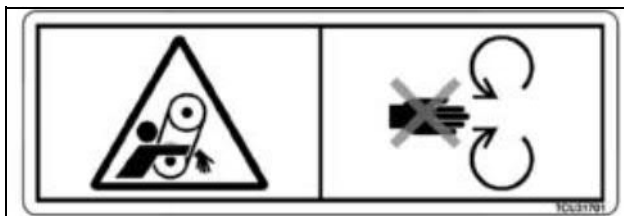

TCU31701

- To avoid injury from rotating belts, keep all shields and guards in place.

Avoid Injury

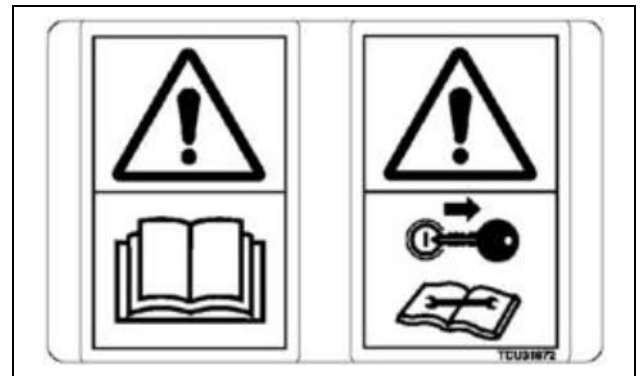

TCU31972

- Operator training required
- Read operator's manual
- Do not operate the machine without guards, shields, and safety devices in place and working
- Never carry riders
- Keep people a safe distance away
- Before leaving machine:
 - Stop engine -Set park brake -Remove key

Thrown Objects

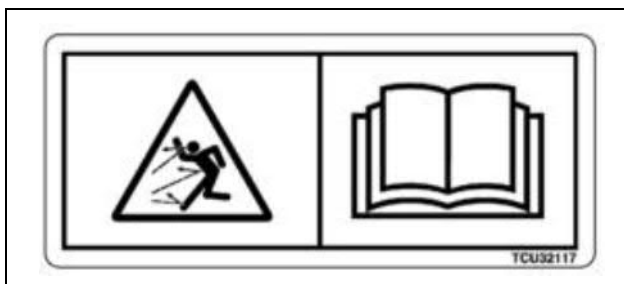

TCU32117

- Stay clear of thrown or flying objects.
- Read operator's manual.

Safety Labels

Avoid Injury



TCU34037

- To avoid injury to children, stop mower when children are near. Do not mow in reverse. Look behind when backing. Never carry riders, especially children.

Prevent Equipment Fires

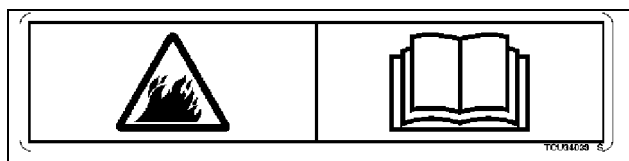

TCU34033

- Clean and inspect the entire machine.
- Carefully read Operator's Manual Machine Cleanout section for details.

Safety

Operator Training Required

- Read the operator's manual and other training material. If the operator or mechanic cannot read English, it is the owner's responsibility to explain this material to them. This publication is available in other languages.
- Become familiar with the safe operation of the equipment, operator controls, and safety signs.
- All operators and mechanics should be trained. The owner of the machine is responsible for training the users.
- Never let children or untrained people operate or service the equipment. Local regulations may restrict the age of the operator.
- The owner/user can prevent and is responsible for accidents or injuries occurring to themselves, other people, or property.
- Operate the machine in an open, unobstructed area under the direction of an experienced operator.

Preparation

- Evaluate the terrain to determine what accessories and attachments are needed to properly and safely perform the job. Only use accessories and attachments approved by the manufacturer.
- Wear appropriate clothing including hard hat, safety glasses and hearing protection. Long hair, loose clothing or jewelry may get tangled in moving parts.
- Inspect the area where the equipment is to be used and remove all objects such as rocks, toys and wire which can be thrown by the machine.
- Use extra care when handling gasoline and other fuels. They are flammable and vapors are explosive.
 - a. Use only an approved container.
 - b. Never remove gas cap or add fuel when engine is running. Do not smoke.
 - c. Never refuel or drain the machine indoors.
- Check that the operator's presence controls, safety switches and shields are attached and functioning properly. Do not operate unless they are functioning properly.

Operating Safely

- Never run an engine in an enclosed area where dangerous carbon monoxide fumes can collect.
- Only operate in good light, keeping away from holes and hidden hazards.
- Be sure all drives are in neutral and parking brake is

engaged before starting engine. Only start engine from the operator's position. Use seat belts if provided.

- Slow down and use extra care on hillsides. Be sure to travel in the recommended direction on hillsides. For this machine, drive across hillsides, not up and down. Turf conditions can affect the machine's stability. Use caution while operating near drop-offs.
- Slow down and use caution when making turns and when changing directions on slopes.
- Never raise deck with the blades running.
- Never operate with the PTO shield, or other guards, not securely in place. Be sure all interlocks are attached, adjusted properly, and functioning properly.
- Never operate with the discharge deflector raised, removed or altered, unless using a grass catcher. Do not operate mower without discharge chute or entire grass catcher in place.
- Do not change the engine governor setting or overspeed the engine. Operating the engine at excessive speed can increase the hazard of personal injury.
- Stop on level ground, lower implements, disengage drives, engage parking brake, and shut off engine before leaving the operator's position for any reason including emptying the grass catchers or unclogging the chute.
- Stop equipment and inspect blades after striking objects or if an abnormal vibration occurs. Make necessary repairs before resuming operations.
- Keep hands and feet away from the cutting units.
- Look behind and down before backing up to be sure of a clear path.
- Never carry passengers and keep pets and bystanders away.
- Slow down and use caution when making turns and crossing roads and sidewalks. Stop blades if not mowing. Watch for traffic when operating near or crossing roadways.
- Be aware of the mower discharge direction and do not point it at anyone.
- Do not operate the machine while under the influence of alcohol or drugs.
- Use care when loading or unloading the machine into or off of a trailer or truck.
- Use care when approaching blind corners, shrubs, trees, or other objects that may obscure vision.
- Inspect machine before you operate. Be sure hardware is tight. Repair or replace damaged, badly worn, or missing parts. Be sure guards and shields are in good condition and fastened in place. Make any necessary adjustments before you operate.

Safety

- Before using, always visually inspect to see that the blades, blade bolts and the mower assembly are not worn and damaged. Replace worn and damaged blades and bolts in sets to preserve balance.
- Keep safety labels visible when installing accessories and attachments.
- Do not wear radio or music headphones. Safe service and operation require your full attention.
- When machine is left unattended, stored, or parked, lower the mower deck unless a positive mechanical lock is used.

Using a Spark Arrestor

The California Public Resources Code, section 4442.5 provides as follows:

No person shall sell, offer for sale, lease, or rent to any person any internal combustion engine subject to Section 4442 or 4443, and not subject to Section 13005 of the Health and Safety Code, unless the person provides a written notice to the purchaser or bailee, at the time of sale or at the time of entering into the lease or rental contract, stating that it is a violation of Section 4442 or 4443 to use or operate the engine on any forest-covered, brush-covered, or grass-covered land unless the engine is equipped with a spark arrestor, as defined in Section 4442, maintained in effective working order or the engine is constructed, equipped, and maintained for the prevention of fire pursuant to Section 4443. Cal. Pub. Res. Code 4442.5.

Other states or jurisdictions may have similar laws. A spark arrestor for your machine may be available from your authorized dealer. An installed spark arrestor must be maintained in good working order by the operator.

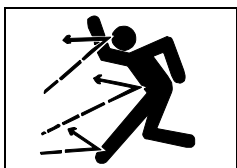

Checking Mowing Area

- Clear mowing area of objects that might be thrown. Keep people and pets out of mowing area.
- Low-hanging branches and similar

obstacles can injure the operator or interfere with mowing operation. Before mowing, identify potential obstacles such as low-hanging branches, and trim or remove those obstacles.

- Study mowing area. Set up a safe mowing pattern. Do not mow where traction or stability is doubtful.
- Test drive area with mower lowered but not running. Slow down when you travel over rough ground.
- Survey all mowing sites to determine which slopes are safe for machine operation and which slopes should be

maintained through other maintenance techniques.

Parking Safely

1. Stop machine on a level surface, not on a slope.
2. Move motion control levers out to the neutral lock position.
3. Disengage mower blades.
4. Lower attachments to the ground.
5. Lock the park brake.
6. Stop the engine.
7. Remove the key.
8. Wait for engine and all moving parts to stop before you leave the operator's seat.
9. Close fuel shut-off valve, if your machine is equipped.
10. Disconnect the negative battery cable or remove the spark plug wire(s) (for gasoline engines) before servicing the machine.

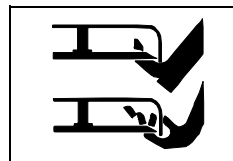

Rotating Blades are Dangerous

HELP PREVENT SERIOUS OR FATAL ACCIDENTS:

- Rotating blades can cut off arms and legs, and throw objects. Failure to observe safety instructions could result in serious injury or death.
- Keep hands, feet and clothing away from mower deck when engine is running.
- Be alert at all times, drive forward carefully. People, especially children can move quickly into the mowing area before you know it.
- Do not mow in reverse.
- Shut off blades when you are not mowing.
- Park machine safely before leaving the operator station for any reason including emptying the catchers or unplugging the chute.

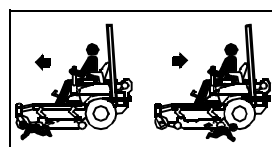

Protect Children

- Death or serious injury can occur when young children associate having fun with a lawn mowing machine simply because someone has given them a ride on a machine.

Safety

- Children are attracted to lawn mowing machines and mowing activities. They don't understand the dangers of rotating blades or the fact that the operator is unaware of their presence.
- Children who have been given rides in the past may suddenly appear in the mowing area for another ride and be run over or backed over by the machine.
- Tragic accidents with children can occur if the operator is not alert to the presence of children, especially when a child approaches a machine from behind. Before and while backing up, stop mower blades and look down and behind the machine carefully, especially for children.
- Never carry children on a machine or attachment, even with the blades off. Do not tow children in a cart or trailer. They can fall off and be seriously injured or interfere with safe machine operation.
- Never use the machine as a recreational vehicle or to entertain children.
- Never allow children or an untrained person to operate the machine. Instruct all operators not to give children a ride on the machine or in an attachment.
- Keep children indoors, out of the mowing area, and in the watchful eye of a responsible adult, other than the operator, when a mower is being operated.
- Stay alert to the presence of children. Never assume that children will remain where you last saw them. Turn the machine off if a child enters the work area.

Identify Slopes for Safe Operation

- Establish your own special procedures and rules for operating on slopes. These procedure must include a survey of all mowing sites to determine which slopes are safe for machine operation. Always use common sense and good judgement when performing this survey.
- Lay a straight piece of sturdy lumber 1.2 m (4 ft) long on the slope and measure the angle of the slope with an angle indicator or protractor level.
- Never mow or operate machine on slope angles greater than 20°.
- Exceeding the maximum recommended slope angle of 20° increases the risk of rollover accidents that can result in serious injury or death.
- Always consider potential turf conditions and slope angles when determining the risk of loss-of-control and tip-over accidents.
- On slope angles of 10° or less the risk of rollover is low, but as the slope angle increases to the John Deere recommended maximum of 20° the risk increases to a moderate level.

- The recommended slope angles are for a machine in its basic configuration. The basic configuration is mower deck only, no cab, MCS or other attachments. The addition of a cab, MCS or other attachments will increase the risk of a rollover and decrease the recommended operating slope.

Operate Safely on Slopes

- Slopes are a major factor related to loss-of-control and tip-over accidents, which can result in severe injury or death. Operation on all slopes requires extra caution.
- Use lower speeds while mowing and operating on slopes.
- If you feel uneasy on a hillside, do not mow it.
- Mow across slopes, not up and down.
- Watch for holes, ruts, bumps, rocks, or other hidden objects. Uneven terrain could overturn the machine. Tall grass can hide obstacles.
- Choose a low ground speed so you will not have to stop while on a slope.
- Rollover can occur before the tires lose traction.
- Use caution if mowing when grass is wet or slippery. Tires may lose traction. Tires may lose traction or slip on slopes even though the brakes are functioning properly.
- Avoid starting, stopping or turning on a slope. If the tires lose traction, disengage the PTO and proceed slowly down the slope.
- Keep all movement on slopes slow and gradual. Do not make sudden changes in speed or direction, which could cause the machine to roll over.
- Keep mower deck lowered to ground while operating on slopes. Raising mower deck while operating on slopes can cause machine to become unstable.



Suggest:

If the above button click is invalid.

Please download this document

first, and then click the above link

to download the complete manual.

Thank you so much for reading

Safety

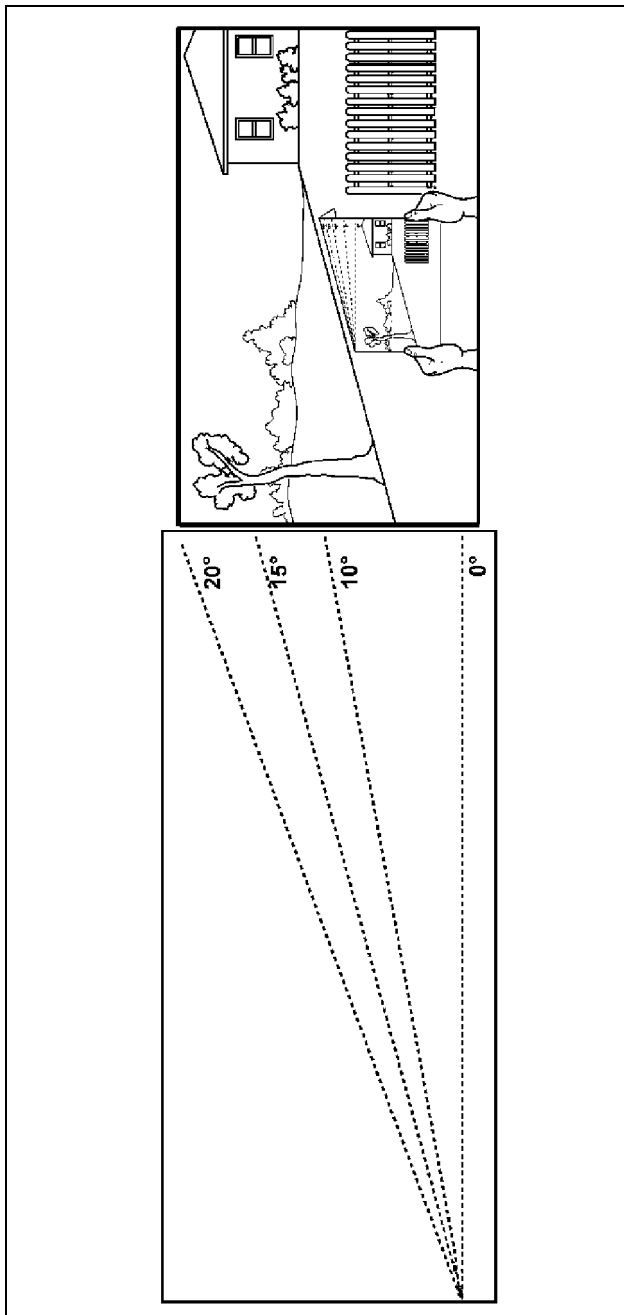

MX51997

Operate Safely Near Edges

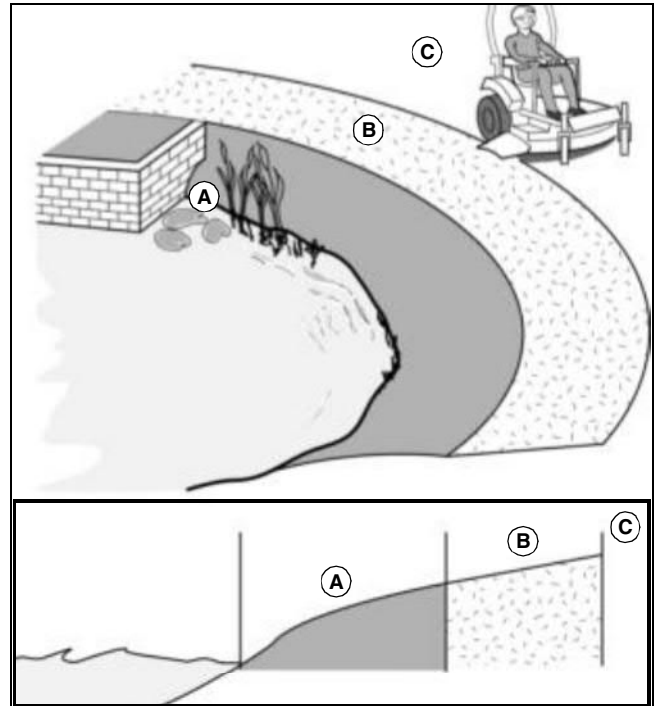

MX51887

Picture Note: Example side view of slope and hazards, showing areas (A), (B), and (C)

- Do not mow or operate machine in areas adjacent to hazards that may cause the machine to roll over. The machine could suddenly lose traction, slide, and/or roll over if a wheel goes over the edge or if the edge breaks away.
- Hazards (A) include but are not limited to:
 - Drop-offs, ditches, embankments, or bodies of water and
 - Areas of unsafe slope, soft ground, edges along bodies of water, or area with holes, ruts, bumps, or other hidden objects.
- Maintain a buffer area (B) at least as wide as the machine between hazards (A) and the mowing area (C). Do not mow or operate the machine in the hazard area or buffer area.
- Use a walk-behind mower or string trimmer in and around areas (A) and (B).
- Only mow or operate the machine in the mowing area (C). Do not exceed the recommended slope operating angle. Refer to the "Operate Safely on Slopes" section.

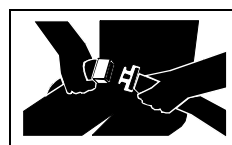

Use Seat Belt Properly

- Use a seat belt when operating with the folding Roll-Over Protective Structure (ROPS) in the upright

<https://www.ebooklibonline.com>

Hello dear friend!

Thank you very much for reading.

Enter the link into your browser.

The full manual is available for immediate download.

<https://www.ebooklibonline.com>