

**JOHN DEERE**  
**WORLDWIDE COMMERCIAL & CONSUMER**  
**EQUIPMENT DIVISION**

---

**John Deere Ultimate Series Tractors**  
**X700, X720, X724, X728, X729**  
**Ultimate Series**  
**OMM162947 G0**  
**OPERATOR'S MANUAL**



**JOHN DEERE**

**⚠ WARNING:** The Engine Exhaust from this product contains chemicals known to the State of California to cause cancer, birth defects or other reproductive harm.

California Proposition 65 Warning

North American Version  
Litho in U.S.A.

---

# INTRODUCTION

---

## Thank You for Purchasing a John Deere Product

We appreciate having you as a customer and wish you many years of safe and satisfied use of your machine.

## Using Your Operator's Manual

This manual is an important part of your machine and should remain with the machine when you sell it.

Reading your operator's manual will help you and others avoid personal injury or damage to the machine. Information given in this manual will provide the operator with the safest and most effective use of the machine. Knowing how to operate this machine safely and correctly will allow you to train others who may operate this machine.

If you have an attachment, use the safety and operating information in the attachment operator's manual along with the machine operator's manual to operate the attachment safely and correctly.

This manual and safety signs on your machine may also be available in other languages (see your authorized dealer to order).

Sections in your operator's manual are placed in a specific order to help you understand all the safety messages and learn the controls so you can operate this machine safely. You can also use this manual to answer any specific operating or servicing questions. A convenient index located at the end of this book will help you to find needed information quickly.

The machine shown in this manual may differ slightly from your machine, but will be similar enough to help you understand our instructions.

RIGHT-HAND and LEFT-HAND sides are determined by facing in the direction the machine will travel when going forward. When you see a broken line (-----), the item referred to is hidden from view.

Before delivering this machine, your dealer performed a predelivery inspection to ensure best performance.

## Special Messages

Your manual contains special messages to bring attention to potential safety concerns, machine damage as well as helpful operating and servicing information. Please read all the information carefully to avoid injury and machine damage.



**CAUTION: Avoid injury! This symbol and text highlight potential hazards or death to the operator or bystanders that may occur if the hazards or procedures are ignored.**

**IMPORTANT: Avoid damage! This text is used to tell the operator of actions or conditions that might result in damage to the machine.**

**NOTE: General information is given throughout the manual that may help the operator in the operation or service of the machine.**

## Attachments for Your Machine

There's a John Deere attachment or kit to make your new machine perform more tasks or be more versatile, whether your machine is a lawn tractor or compact utility tractor or a utility vehicle.

You can check out the entire line of attachments for your machine at [JohnDeere.com](http://JohnDeere.com) or ask your John Deere dealer. From aerators to electric lift kits to tillers, there's a John Deere attachment or kit to fill every need.

# PRODUCT IDENTIFICATION

---

## Record Identification Numbers

Ultimate™ Series Tractors

X700, X720, X724, X728, X729 PIN (060001-)

If you need to contact an Authorized Service Center for information on servicing, always provide the product model and serial number.

You will need to locate the model and serial number for the machine and for the engine of your machine and record the information in the spaces provided below.

DATE OF PURCHASE:

\_\_\_\_\_

DEALER NAME:

\_\_\_\_\_

DEALER PHONE:

\_\_\_\_\_

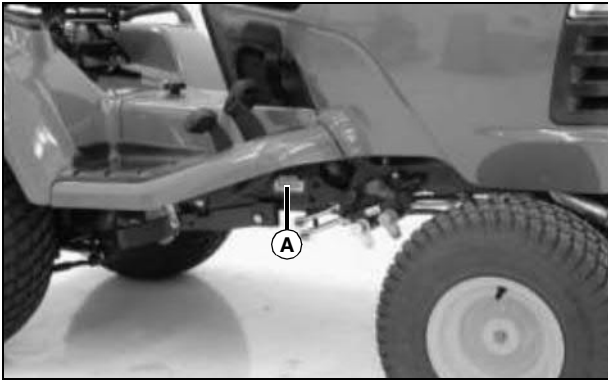

MX13553

PRODUCT IDENTIFICATION NUMBER (A):

-----

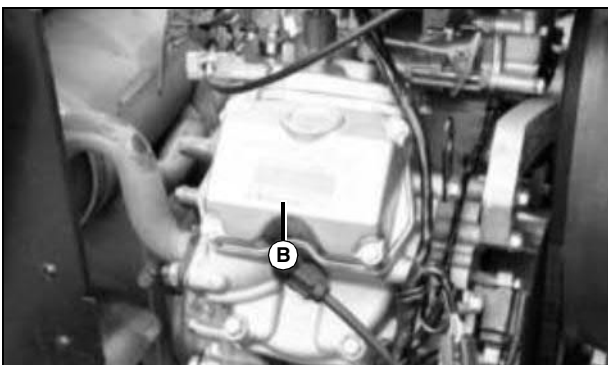

MX35710

ENGINE SERIAL NUMBER (B):

-----

**<https://www.ebooklibonline.com>**

Hello dear friend!

Thank you very much for reading.

Enter the link into your browser.

The full manual is available for immediate download.

**<https://www.ebooklibonline.com>**

---

---

# TABLE OF CONTENTS

---

---

|                             |    |
|-----------------------------|----|
| Safety Labels .....         | 1  |
| Safety .....                | 4  |
| Operating - Controls .....  | 10 |
| Operating .....             | 11 |
| Replacement Parts .....     | 33 |
| Service Intervals .....     | 34 |
| Service Lubrication .....   | 35 |
| Service Engine .....        | 37 |
| Service Transmission .....  | 48 |
| Service Electrical .....    | 51 |
| Service Miscellaneous ..... | 55 |
| Troubleshooting .....       | 60 |
| Storage .....               | 64 |
| Specifications .....        | 66 |
| Warranty .....              | 70 |
| Index .....                 | 72 |

Original Instruction

All information, illustrations and specifications in this manual are based on the latest information at the time of publication. The right is reserved to make changes at any time without notice.

COPYRIGHT© 2010

Deere & Co.

John Deere Worldwide Commercial and Consumer Equipment Division

All rights reserved

Previous Editions

COPYRIGHT© 2005, 2006, 2007, 2008, 2009

OMM162947 G0 - English

# SAFETY LABELS

## Safety Label Location

**TRACTION ASSIST**

LOWER  
RAISE  
FLIGHT  
LOWER  
RAISE

Assembled by John Deere in Waterloo, IA USA

**CRUISE**

CRUISE ON  
• Depress Forward Pedal  
• Raise Latch  
CRUISE OFF  
• Depress Forward Pedal or Brake Pedal

**BRAKE**

FWD REV  
PARK BRAKE  
• Depress brake  
• Raise latch  
• Depress brake  
• Lower latch

**ROTATING BLADES CUT OFF ARMS AND LEGS**

• Do not mow when children or others are around  
• Do not mow in reverse  
• Lock, stores and behind before and while backing up  
• Never carry children even with blades off

**AVOID SERIOUS INJURY OR DEATH**

• Read operator's manual  
• Drive up and down slopes, not across  
• Avoid sudden turns  
• Avoid slopes (beliefs for operating conditions and machine capabilities - Slope grade is marked)  
• If traveling down gully uphill, stop blades and lock down slowly  
• Keep safety devices (guards, shields and switches) in place and working  
• Restore engine lock, set PTO and PTO blade  
• When leaving machine:  
• Stop engine, set park brake, remove key

**LIFT ADJUST STOP**

Adjust with implement in raised position

**TRACTION ASSIST**

LOWER  
RAISE  
FLIGHT  
LOWER  
RAISE

Assembled by John Deere in Waterloo, IA USA

**CRUISE**

CRUISE ON  
• Depress Forward Pedal  
• Raise Latch  
CRUISE OFF  
• Depress Forward Pedal or Brake Pedal

**BRAKE**

FWD REV  
PARK BRAKE  
• Depress brake  
• Raise latch  
• Depress brake  
• Lower latch

**ROTATING BLADES CUT OFF ARMS AND LEGS**

• Do not mow when children or others are around  
• Do not mow in reverse  
• Lock, down and behind before and while backing up  
• Never carry children even with blades on

**AVOID SERIOUS INJURY OR DEATH**

• Read operator's manual  
• Drive up and down slopes, not across  
• Avoid sudden turns  
• Avoid slopes (beliefs for operating conditions and machine capabilities - See operator's manual)  
• If traveling down gully uphill, stop blades and lock down slowly  
• Keep safety devices (guards, shields and switches) in place and working  
• Restore engine lock, set PTO and PTO blade  
• When leaving machine:  
• Stop engine, set park brake, remove key

**LIFT ADJUST STOP**

Adjust with implement in raised position

**WARNING**

**AVOID INJURY from**

- Keep all shields in place and working
- Keep hands, feet and clothing away from moving parts
- Operate only with seat belt fastened

**DANGER**

**SHIELD EYES FROM EXPLOSIVE GASES CAN CAUSE BLINDNESS OR INJURY**

**NO SPARKS, FLAMES OR SMOKING**

**SULFURIC ACID CAN CAUSE BLINDNESS OR SEVERE BURNS**

**CAUTION**

**FLUSH EYES IMMEDIATELY WITH WATER. GET MEDICAL HELP IF NEEDED.**

**KEEP OUT OF REACH OF CHILDREN. DO NOT TIP. KEEP VENT CAPS TIGHT AND LEVEL.**

**RECYCLE**

**WARNING**

**Operation of This Equipment May Create Sparks That Can Start Fires Around Dry Vegetation. A Spark Arrestor May be Required. The Operator Should Contact Local Fire Agencies For Laws or Regulations Relating to Fire Prevention Requirements.**

MX41156

B - DANGER M161152 (X724 and 729 only)

C - CAUTION (MOLDED INTO MUFFLER)

D - WARNING M159705

E - DANGER M128699 (ON BATTERY)

F - WARNING M146727

Picture Note: Use label number listed in table below to locate complete text of safety label message following this illustration.

A - DANGER M161153 (X700, X720 and X728 only)

# SAFETY LABELS



## Understanding The Machine Safety Labels

The machine safety labels shown in this section are placed in important areas on your machine to draw attention to potential safety hazards.

On your machine safety labels, the words DANGER, WARNING, and CAUTION are used with this safety-alert symbol. DANGER identifies the most serious hazards.

The operator's manual also explains any potential safety hazards whenever necessary in special safety messages that are identified with the word, CAUTION, and the safety-alert symbol.

There can be additional safety information contained on parts and components sourced from suppliers that is not reproduced in this operator's manual.

### DANGER - M161152/M161153



M161152, M161153

#### ROTATING BLADES CUT OFF ARMS AND LEGS

- Do not mow when children or others are around
- Do not mow in reverse
- Look down and behind before and while backing
- Never carry children even with blades off

### WARNING - M161152/M161153

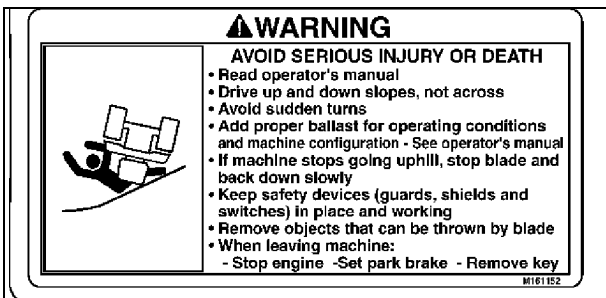

M161152, M161153

#### AVOID SERIOUS INJURY OR DEATH

- Read operator's manual.
- Drive up and down slopes, not across.

- Avoid sudden turns.
- Add proper ballast for operating conditions and machine configuration - See operators manual.
- If machine stops going uphill, stop blade and back down slowly.
- Keep safety devices (guards, shields, and switches) in place and working.
- Remove objects that can be thrown by blade.
- When leaving machine: Stop engine, Set park brake, Remove key.

### WARNING: AVOID INJURY from PTO

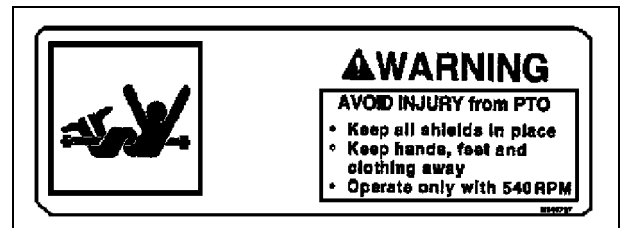

M146727

- Keep all shields in place.
- Keep hands, feet and clothing away.
- Operate only with 540 RPM.

### CAUTION - HOT SURFACE



MIF

Picture Note: No-text warning molded into shield.

- Do not touch engine muffler, it may be hot.

# SAFETY LABELS

## DANGER M128699

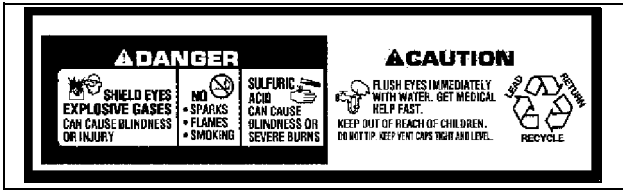

M128699

**Picture Note: Located on battery**

- Shield eyes, explosive gases can cause blindness or injury.
- No sparks, flames, smoking.
- Sulfuric acid can cause blindness or severe burns.
- Flush eyes immediately with water. Get medical help fast.
- Keep out of reach of children.
- Do not tip.
- Keep vent caps tight and level.

## Warning M159705



M159705

**Picture Note: This label is required and installed on machines sold in California. This label may also be installed on machines sold in other locations.**

Operation of This Equipment May Create Sparks that Can Start Fires Around Dry Vegetation. A Spark Arrestor May be Required. The Operator Should Contact Local Fire Agencies For Laws or Regulations Relating to Fire Prevention Requirements.

## Emission Control System Certification Label

**NOTE: Tampering with emission controls and components by unauthorized personnel may result in severe fines or penalties. Emission controls and components can only be adjusted by EPA and/or CARB authorized service centers. Contact your John Deere Commercial and Consumer Equipment Retailer concerning emission controls and component**

## questions.

The presence of an emissions label signifies that the engine has been certified with the United States Environmental Protection Agency (EPA) and/or California Air Resources Board (CARB).

The emissions warranty applies only to those engines marketed by John Deere that have been certified by the EPA and/or CARB; and used in the United States and Canada in off-road mobile equipment.

## Emission Compliance Period

If your engine has the emission compliance category listed on the emission control system certification or air index label, this indicates the number of operating hours for which the engine has been certified to meet EPA and/or CARB emission requirements. The following table provides the engine compliance period in hours associated with the category found on the certification label.

| Agency | Category     | Hours |
|--------|--------------|-------|
| EPA    | C            | 250   |
| EPA    | B            | 500   |
| EPA    | A            | 1000  |
| CARB   | Moderate     | 125   |
| CARB   | Intermediate | 250   |
| CARB   | Extended     | 500   |

## Certification

Your mower has been certified for compliance with American National Standards Institute B-71.1-2003, "Safety Specifications" for Power Lawn Mowers, Lawn and Garden Tractors, and Lawn Tractors.

# SAFETY

---

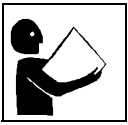

## Operating Safely

This cutting machine is capable of amputating hands and feet and throwing objects. Failure to observe the following safety instructions could result in serious injury or death.

- Read, understand and follow all instructions on the machine and in manuals provided, and view safety video, before starting. Be thoroughly familiar with the controls and the proper use of the machine before starting.
- Do not put hands or feet near rotating parts or under the machine. Keep clear of the discharge opening at all times.
- Only allow responsible adults, who are familiar with the instructions, to operate this machine. Local regulations may restrict the age of the operator.
- Clear the area of objects such as rocks, wire and toys which could be thrown by the blades.
- Be sure the area is clear of bystanders before operating. Stop machine if anyone enters the area.
- Never carry passengers.
- Do not mow in reverse unless absolutely necessary. Always look down and behind before and while backing.
- Never direct discharged material toward anyone. Avoid discharging material against a wall or obstruction. Material may ricochet back toward the operator. Stop the blades when crossing gravel surfaces.
- Do not operate the machine without the entire grasscatcher, discharge guard, or other safety devices in place and working. Never operate with the discharge deflector raised, removed, or altered, unless using a grasscatcher.
- Slow down before turning.
- Never leave a running machine unattended. Always turn off blades, lock park brake, stop engine and remove key before dismounting.
- Disengage blades when not mowing. Shut off engine and wait for all parts to come to a complete stop before cleaning the machine, removing the grasscatcher, or unclogging the discharge chute.
- Operate machine only in daylight or good artificial light.
- Do not operate the machine while under the influence of alcohol or drugs.
- Watch for traffic when operating near or crossing roadways. Stop blades before crossing roads or sidewalks.
- Use extra care when loading or unloading the machine into a trailer or truck.
- Always wear safety goggles or safety glasses with side shields when operating machine.
- Data indicates operators 60 years and above are involved

in a large percentage of riding mower-related injuries. These operators should evaluate their ability to operate the riding mower safely enough to protect themselves and others from serious injury.

- Follow the manufacturer's recommendation for wheel weights or counterweights.
- Inspect machine before you operate. Be sure hardware is tight. Repair or replace damaged, badly worn, or missing parts. Be sure guards and shields are in good condition and fastened in place. Make any necessary adjustments before you operate.
- Before using, always visually inspect to see that the blades, blade bolts and the mower assembly are not worn and damaged. Replace worn and damaged blades and bolts in sets to preserve balance.
- Make sure spark plug, muffler, fuel cap and air cleaner are in place before starting the engine.
- Be sure all drives are in neutral and parking brake is locked before starting engine. Only start engine from the operator's position.
- Do not change the engine governor settings or overspeed the engine. Operating the engine at excessive speed can increase the hazard of personal injury.
- If you hit an object or if abnormal vibration occurs, stop the machine and inspect it. Make repairs before you operate.
- Use only accessories and attachments approved by the manufacturer of the machine. Keep safety labels visible when installing accessories and attachments.
- Do not wear radio or music headphones. Safe service and operation requires your full attention.
- When machine is left unattended, stored, or parked, lower the mower deck unless a positive mechanical lock is used.

## Using a Spark Arrestor

The engine in this machine is not equipped with a spark arrestor muffler. The California Public Resources Code, section 4442.5 provides as follows:

No person shall sell, offer for sale, lease, or rent to any person any internal combustion engine subject to Section 4442 or 4443, and not subject to Section 13005 of the Health and Safety Code, unless the person provides a written notice to the purchaser or bailee, at the time of sale or at the time of entering into the lease or rental contract, stating that it is a violation of Section 4442 or 4443 to use or operate the engine on any forest-covered, brush-covered, or grass-covered land unless the engine is equipped with a spark arrestor, as defined in Section 4442, maintained in effective working order or the engine is

# SAFETY

constructed, equipped, and maintained for the prevention of fire pursuant to Section 4443. Cal. Pub. Res. Code 4442.5.

Other states or jurisdictions may have similar laws. A spark arrestor for your machine may be available from your authorized dealer. An installed spark arrestor must be maintained in good working order by the operator.

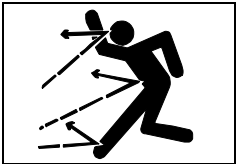

## Checking Mowing Area

- Clear mowing area of objects that might be thrown. Keep people and pets out of mowing area.

- Low-hanging branches and similar obstacles can injure the operator or interfere with mowing operation. Before mowing, identify potential obstacles such as low-hanging branches, and trim or remove those obstacles.

- Study mowing area. Set up a safe mowing pattern. Do not mow where traction or stability is doubtful.

- Test drive area with mower lowered but not running. Slow down when you travel over rough ground.

## Parking Safely

1. Stop machine on a level surface, not on a slope.
2. Disengage mower blades or any other attachments.
3. Lower attachments to the ground.
4. Lock the park brake.
5. Stop the engine.
6. Remove the key.
7. Wait for engine and all moving parts to stop before you leave the operator's seat.
8. Close fuel shut-off valve, if your machine is equipped.
9. Disconnect the negative battery cable or remove the spark plug wire(s) (for gasoline engines) before servicing the machine.

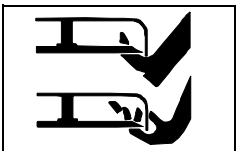

## Rotating Blades are Dangerous

**HELP PREVENT SERIOUS OR FATAL ACCIDENTS:**

- Rotating blades can cut off arms and legs, and throw objects. Failure to observe safety instructions could result in serious injury or death.

- Keep hands, feet and clothing away from mower deck when engine is running.
- Be alert at all times, drive forward and in reverse carefully. People, especially children can move quickly into the mowing area before you know it.
- Before backing up, stop mower blades or attachments and look down and behind the machine carefully, especially for children.
- Do not mow in reverse.
- Shut off blades when you are not mowing.
- Park machine safely before leaving the operator's station for any reason including emptying the grasscatchers or unplugging the chute.
- The mower blades should stop in approximately five seconds when the mower is disengaged. If you believe that your blades may not be stopping in that period of time, take your machine to your authorized dealer where they can safely check and service your machine.

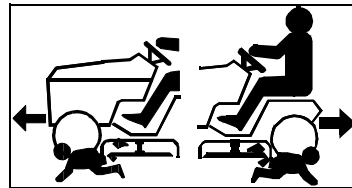

## Protect Children

- Death or serious injury can occur when young children associate having fun with a lawn mowing machine simply because

someone has given them a ride on a machine.

- Children are attracted to lawn mowing machines and mowing activities. They don't understand the dangers of rotating blades or the fact that the operator is unaware of their presence.
- Children who have been given rides in the past may suddenly appear in the mowing area for another ride and be run over or backed over by the machine.
- Tragic accidents with children can occur if the operator is not alert to the presence of children, especially when a child approaches a machine from behind. Before and while backing up, stop mower blades and look down and behind the machine carefully, especially for children.
- Never carry children on a machine or attachment, even with the blades off. Do not tow children in a cart or trailer. They can fall off and be seriously injured or interfere with safe machine operation.
- Never use the machine as a recreational vehicle or to entertain children.
- Never allow children or an untrained person operate the machine. Instruct all operators not to give children a ride on the machine or in an attachment.
- Keep children indoors, out of the mowing area, and in the

---

# SAFETY

---

watchful eye of a responsible adult, other than the operator, when a mower is being operated.

- Stay alert to the presence of children. Never assume that children will remain where you last saw them. Turn the machine off if a child enters the work area.
- Use extreme care when approaching blind corners, shrubs, trees, or other objects that may block your view of a child.



## Avoid Tipping

- Slopes are a major factor related to loss-of-control and tip-over accidents, which can result in severe injury or death. Operation on all slopes

requires extra caution.

- Regardless of the features on your machine, if you feel uneasy on a slope, do not mow it. Some slopes are simply too steep to mow.
- Be aware that a machine that allows all four wheels to drive can provide access to dangerously sloped terrain, thereby increasing the possibility of a tipover.
- The operation of a machine that is equipped with full time four wheel drive and four wheel steer is different. Before using the machine, become familiar with how the machine operates and responds. Be extremely careful and always use common sense and good judgement when operating the machine.
- Check for Slope - Two Wheel Drive (2WD) Machines:
  - Do not operate on a slope if the machine cannot backup the slope with only rear wheel drive engaged, or if you feel uneasy on it.
- Check for Slope - Four Wheel Drive (4WD) Machines:
  - Never mow on any slope that is more than 13 degrees, or a slope that rises more than 4 1/2 feet within a distance of 20 feet of distance.
  - Exceeding the maximum recommended slope angle of 13 degrees increases the risk of rollover accidents that can result in serious injury or death
- With four wheel drive machines, rollover can occur before tires lose traction.
- Sharp turns could cause the machine to tip over. Keep all movement on slopes slow and gradual. Do not make sudden changes in speed or direction.
- Avoid starting, stopping or turning on a slope. If the tires lose traction, disengage the blades and proceed slowly, straight down the slope.
- Mow up and down slopes, not across.

- Watch for holes, ruts, bumps, rocks, or other hidden objects. Uneven terrain could overturn the machine. Tall grass can hide obstacles.
- Choose a low ground speed so you will not have to stop or shift while on a slope.
- Do not mow or operate machine on wet grass. Tires may lose traction. Tires may lose traction on slopes even though the brakes are functioning properly.
- Always keep the machine in gear when going down slopes. Do not shift to neutral and coast downhill.
- Use extra care while operating machine with grasscatchers or other attachments, they can affect stability of the machine. Do not use on steep slopes.
- Do not try to stabilize the machine by putting your foot on the ground.
- Leave at least the width of the machine as a safety area between the machine and any safety hazard. Mow those areas with a hand-held trimmer or walk-behind mower.
- Do not mow near drop-offs, ditches, embankments, or bodies of water. The machine could suddenly roll over if a wheel goes over the edge or the edge caves in.
- Follow the manufacturer's recommendations for wheel weights or counterweights for added stability when operating or using front or rear mounted attachments. Remove weights when not required.



## Keep Riders Off

- Only allow the operator on the machine. Keep riders off.
- Riders on the machine or attachment may be struck by foreign objects or thrown off the machine causing serious injury.
- Riders obstruct the operator's view resulting in the machine being operated in an unsafe manner.

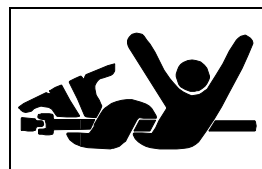

## Stay Clear of Rotating Drivelines

- Entanglement in rotating driveline can cause serious injury or death.
- Wear close fitting clothing.
- Stop the engine and be sure PTO driveline is stopped before getting near it.

# SAFETY

## Checking Wheel Hardware

- A serious accident could occur causing serious injury if wheel hardware is not tight.
- Check wheel hardware tightness often during the first 100 hours of operation.
- Wheel hardware must be tightened to specified torque using the proper procedure anytime it is loosened.

## Towing Loads Safely

- Stopping distance increases with speed and weight of towed load. Travel slowly and allow extra time and distance to stop.
- Total towed weight must not exceed combined weight of pulling machine, ballast and operator. Use counterweights or wheel weights as described in the attachment or pulling machine operator's manual.
- Excessive towed load can cause loss of traction and loss of control on slopes. Reduce towed weight when operating on slopes.
- Never allow children or others in or on towed equipment.
- Use only approved hitches. Tow only with a machine that has a hitch designed for towing. Do not attach towed equipment except at the approved hitch point.
- Follow the manufacturer's recommendations for weight limits for towed equipment and towing on slopes.
- If you cannot back up a slope with a towed load, the slope is too steep to operate on with the towed load. Reduce the towed load or do not operate.
- Do not turn sharply. Use additional caution when turning or operating under adverse surface conditions. Use care when reversing.
- Do not shift to neutral and coast downhill.

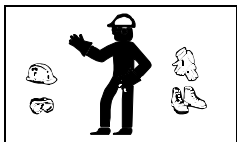

## Wear Appropriate Clothing

- Always wear eye protection when operating the machine.
- Wear close fitting clothing and safety equipment appropriate for the job.
- While operating this machine, always wear substantial footwear and long trousers. Do not operate the equipment when barefoot or wearing open sandals.
- Wear a suitable protective device such as earplugs. Loud noise can cause impairment or loss of hearing.

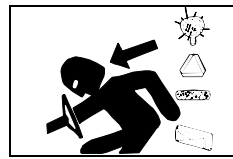

## Driving Safely on Public Roads

Avoid personal injury or death resulting from a collision with another vehicle on public roads:

- Use safety lights and devices. Slow moving machines when driven on public roads are hard to see, especially at night.
- Whenever driving on public roads, use flashing warning lights and turn signals according to local regulations. Extra flashing warning lights may need to be installed.



## Practice Safe Maintenance

- Only qualified, trained adults should service this machine. Understand service procedure before doing work.
- Never operate machine in a closed area where dangerous carbon monoxide fumes can collect.
- Keep all nuts and bolts tight, especially blade attachment bolts, to be sure the equipment is in safe working condition.
- Never tamper with safety devices. Check their proper operation regularly.
- Keep machine free of grass, leaves or other debris build-up. Clean up oil or fuel spillage and remove any fuel-soaked debris. Allow the machine to cool before storing.
- If you strike a foreign object, stop and inspect the machine. Repair, if necessary, before restarting.
- Never make any adjustments or repairs with the engine running. Wait for all movement to stop on machine before adjusting, cleaning or repairing.
- Check grasscatcher components and the discharge guard frequently and replace with manufacturer's recommended parts, when necessary. Grasscatcher components are subject to wear, damage, and deterioration which could expose moving parts or allow objects to be thrown.
- Mower blades are sharp. Wrap the blade or wear gloves, and use extra care when servicing them. Only replace blades. Never straighten or weld them.
- Check brake operation frequently. Adjust and service as required.
- Maintain or replace safety and instruction labels, as necessary.
- On multi-bladed machines, take care as rotating one blade can cause other blades to rotate.
- Keep hands, feet, clothing, jewelry, and long hair away from any moving parts, to prevent them from getting caught.

# SAFETY

- Lower any attachments to the ground before cleaning or servicing machine. Disengage all power and stop the engine. Lock park brake and remove the key. Let machine cool.

- Securely support any machine elements that must be raised for service work. Use jack stands or lock service latches to support components when needed.

- Disconnect battery or remove spark plug wire (for gasoline engines) before making any repairs. Disconnect negative terminal first and positive last. Install positive terminal first and negative last.

- Before servicing machine or attachment, carefully release pressure from any components with stored energy, such as hydraulic components or springs.

- Keep all parts in good condition and properly installed. Fix damage immediately. Replace worn or broken parts.

- Charge batteries in an open, well-ventilated area, away from sparks. Unplug battery charger before connecting or disconnecting from the battery. Wear protective clothing and use insulated tools.

- Do not strike the flywheel with a hammer or hard object because the flywheel may later shatter during operation.

- If equipped with hydraulic lift - release hydraulic pressure by lowering attachment or cutting units to the ground or to a mechanical stop and move hydraulic control levers back and forth.



## Avoid High Pressure Fluids

- Hydraulic hoses and lines can fail due to physical damage, kinks, age, and exposure. Check hoses and lines regularly. Replace damaged hoses

and lines.

- Hydraulic fluid connections can loosen due to physical damage and vibration. Check connections regularly. Tighten loose connections.

- Escaping fluid under pressure can penetrate the skin causing serious injury. Avoid the hazard by relieving pressure before disconnecting hydraulic or other lines. Tighten all connections before applying pressure.

- Search for leaks with a piece of cardboard. Protect hands and body from high pressure fluids.

- If an accident occurs, see a doctor immediately. Any fluid injected into the skin must be surgically removed within a few hours or gangrene may result. Doctors unfamiliar with this type of injury should reference a knowledgeable medical source. Such information is available from Deere & Company Medical Department in Moline, Illinois, U.S.A. Information may be obtained in the United States and

Canada only by calling 1-800-822-8262.



## Prevent Fires

- Machine fires and structure fires can occur if a machine is stored before allowing it to cool, if debris is not removed from critical areas of the machine, or if machine is stored near combustible materials.

- Remove grass and debris completely from engine compartment and muffler area, and from on top of the mower deck, before and after operating machine, especially after mowing or mulching in dry conditions.

- Empty any grasscatcher bags or containers completely before storing.

- Always shut off fuel when storing or transporting machine, if the machine has a fuel shutoff.

- Do not store machine near an open flame or source of ignition, such as a water heater or furnace.

- Check fuel lines, tank, cap, and fittings frequently for cracks or leaks. Replace if necessary.

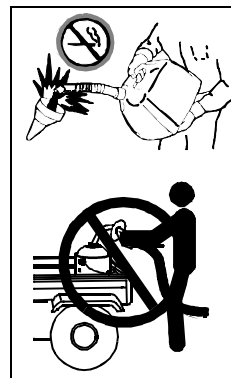

## Handling Fuel Safely

**To avoid personal injury or property damage, use extreme care in handling fuel. Fuel is extremely flammable and fuel vapors are explosive:**

- Extinguish all cigarettes, cigars, pipes, and other sources of ignition.

- Use only an approved fuel container. Use only non-metal, portable fuel containers approved by

the Underwriter's Laboratory (U.L.) or the American Society for Testing & Materials (ASTM). If using a funnel, make sure it is plastic and has no screen or filter.

- Never remove the fuel tank cap or add fuel with the engine running. Allow engine to cool before refueling.

- Never add fuel to or drain fuel from the machine indoors. Move machine outdoors and provide adequate ventilation.

- Clean up spilled fuel immediately. If fuel is spilled on clothing, change clothing immediately. If fuel is spilled near machine, do not attempt to start the engine but move the machine away from the area of spillage. Avoid creating any source of ignition until fuel vapors have dissipated.

- Never store the machine or fuel container where there is an open flame, spark, or pilot light such as on a water

---

# SAFETY

---

heater or other appliance.

- Prevent fire and explosion caused by static electric discharge. Static electric discharge can ignite fuel vapors in an ungrounded fuel container.
- Never fill containers inside a vehicle or on a truck or trailer bed with a plastic liner. Always place containers on the ground away from your vehicle before fueling.
- Remove fuel-powered equipment from the truck or trailer and refuel it on the ground. If this is not possible, then refuel such equipment with a portable container, rather than from a fuel dispenser nozzle.
- Keep the nozzle in contact with the rim of the fuel tank or container opening at all times until the fueling is complete. Do not use a nozzle lock-open device.
- Never overfill fuel tank. Replace fuel tank cap and tighten securely.
- Replace all fuel container caps securely after use.
- For gasoline engines, do not use gas with methanol. Methanol is harmful to your health and to the environment.

safety procedures, and emergency response techniques. The seller of the chemical products used with your machine is responsible for providing the MSDS for that product.



## Tire Safety

Explosive separation of a tire and rim parts can cause serious injury or death:

- Do not attempt to mount a tire without the proper equipment and experience to perform the job.
- Always maintain the correct tire pressure. Do not inflate the tires above the recommended pressure. Never weld or heat a wheel and tire assembly. The heat can cause an increase in air pressure resulting in a tire explosion. Welding can structurally weaken or deform the wheel.
- When inflating tires, use a clip-on chuck and extension hose long enough to allow you to stand to one side and NOT in front of or over the tire assembly.
- Check tires for low pressure, cuts, bubbles, damaged rims or missing lug bolts and nuts.

## Handling Waste Product and Chemicals

Waste products, such as, used oil, fuel, coolant, brake fluid, and batteries, can harm the environment and people:

- Do not use beverage containers for waste fluids - someone may drink from them.
- See your local Recycling Center or authorized dealer to learn how to recycle or get rid of waste products.
- A Material Safety Data Sheet (MSDS) provides specific details on chemical products: physical and health hazards,

# OPERATING - CONTROLS

## Operator Station Controls

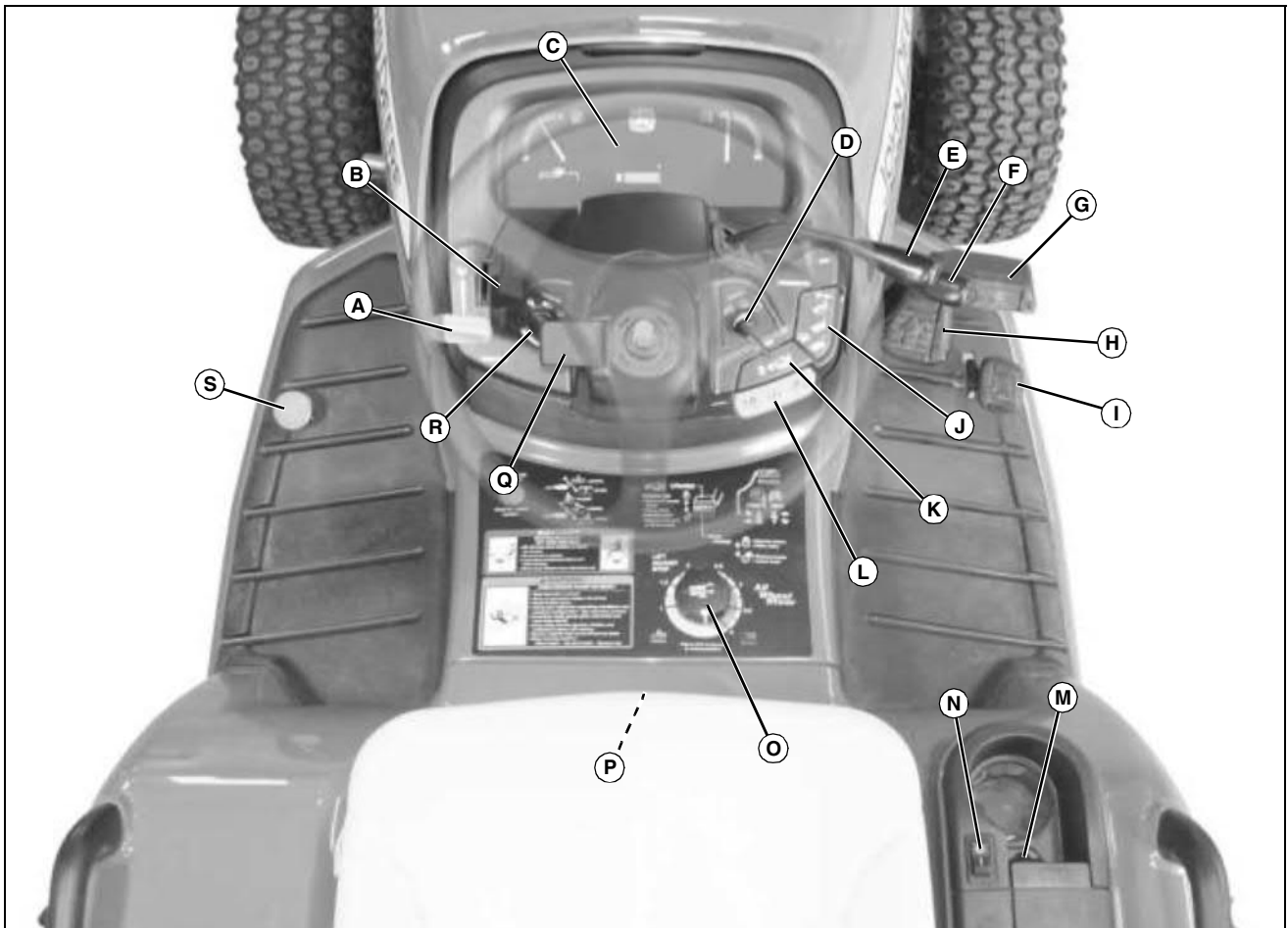

MX39014

| Key | Description                                    | Key | Description                 |
|-----|--|-----|-----------------------------|
| A   | Throttle Lever                                 | K   | Cruise Control Switch       |
| B   | Choke Lever (X700 only)                        | L   | Park Brake Lock             |
| C   | Instrument Panel (Gauges and Indicator Lights) | M   | 12V Accessory Outlet        |
| D   | Key Switch                                     | N   | 12V Accessory Outlet Switch |
| E   | Hydraulic Control Lever, Upper                 | O   | Mower Height Control Knob   |
| F   | Hydraulic Control Lever, Lower                 | P   | Seat Slide Lever            |
| G   | Brake Pedal                                    | Q   | Tilt Steering Lever         |
| H   | Forward Control Pedal                          | R   | Light Switch                |
| I   | Reverse Control Pedal                          | S   | Traction Assist Pedal       |
| J   | PTO/RIO Switch                                 |     |                             |

# OPERATING

## Daily Operating Checklist

- Test safety systems.
- Check tire pressure.
- Check fuel level. (See SERVICE MISCELLANEOUS section, Using Proper Fuel and Stabilizer)
- Check engine oil level.
- Check transmission oil level.
- Check coolant level on liquid cooled engine.
- Remove grass and debris from engine compartment and muffler area, and on top of mower deck, before and after operating machine.
- Clean air intake screens.
- Check area below machine for leaks.
- Check operation of backup lights.

**IMPORTANT: Avoid damage! Using stale, contaminated or improper fuel can result in engine and fuel system damage. Repairs caused by stale, contaminated or improper fuel are not covered by warranty.**

## Avoid Damage to Plastic and Painted Surfaces

- Do not wipe plastic parts unless rinsed first. Using a dry cloth may cause scratches.
- Insect repellent spray may damage plastic and painted surfaces. Do not spray insect repellent near machine.
- Be careful not to spill fuel on machine. Fuel may damage surface. Wipe up spilled fuel immediately.
- Prolonged exposure to sunlight will damage hood surfaces.

## Adjusting Tilt Steering Wheel

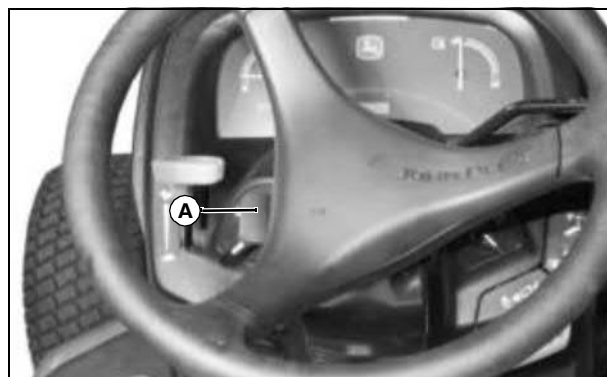

MX35705

1. Pull up on tilt steering lever (A).
2. Push or pull steering wheel to a comfortable operating position.
3. Release lever.
4. Check to be sure steering wheel is locked in position.

## Adjusting Seat (Standard)

### Adjusting Seat Position With The Slide Adjustment Lever (All Models)



MX39540

**Picture Note: X700 model shown.**

1. Move seat adjustment lever (A) to the left.
2. Slide seat forward or backward to desired position.
3. Release lever.
4. Check to be sure seat is locked in position.

### Changing Slide Rail Position (All Models)

The slide rails can be secured to the fenderdeck in two different sets of mounting holes. This provides an additional front / rear adjustment to extend the range of the basic slide adjustment.

# OPERATING

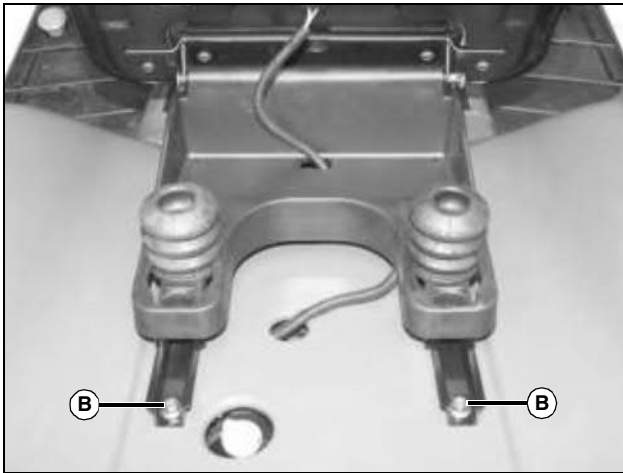

MX39017

**Picture Note: X700 model shown.**

1. Remove and retain two bolts (B) at rear of slide rails.

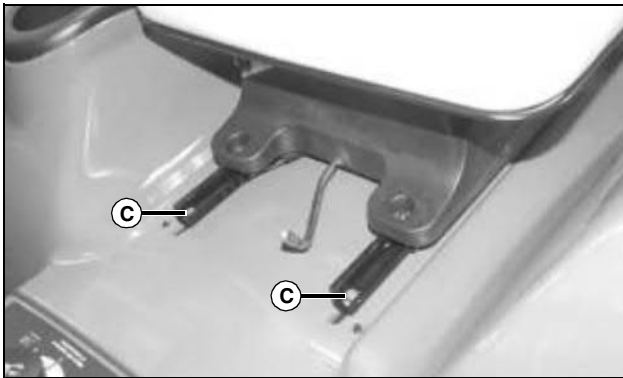

MX39540

**Picture Note: X700 model shown.**

2. Loosen two bolts (C) at front of slide rails.

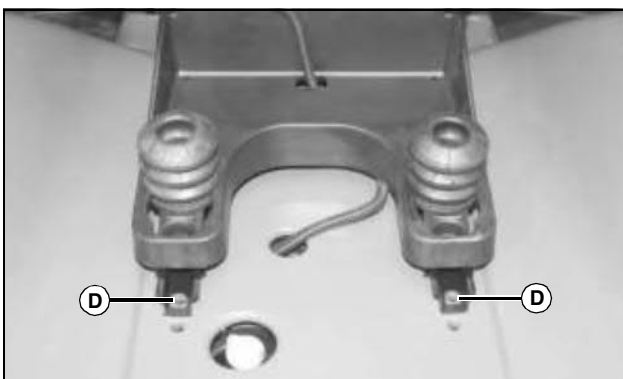

MX39541

**Picture Note: X700 model shown.**

3. Slide rails with seat and suspension forward one inch to align with forward set of mounting holes (D).
4. Install two bolts, removed earlier, at rear of slide rails, then tighten all hardware.

## Adjusting Seat Height and Suspension (X700)

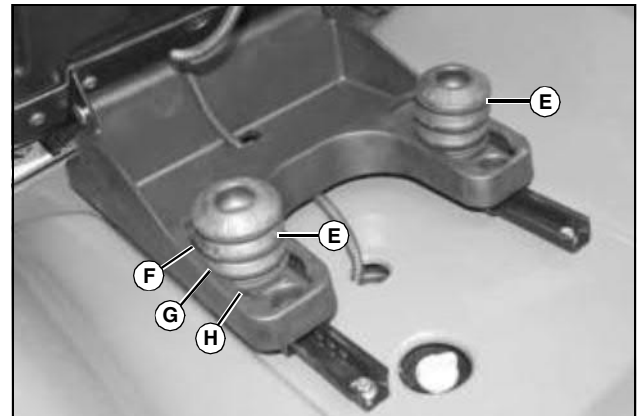

MX39016

Suspension coils (E) may be moved to three different positions in the seat base slots to make minor adjustments in seat height and suspension stiffness:

(F) - Front position. Highest, softest ride.

(G) - Middle Position. Middle height, average ride.

(H) - Rear Position. Lowest, firmest ride.

## Adjusting Seat Height (X720, X724, X728, X729)

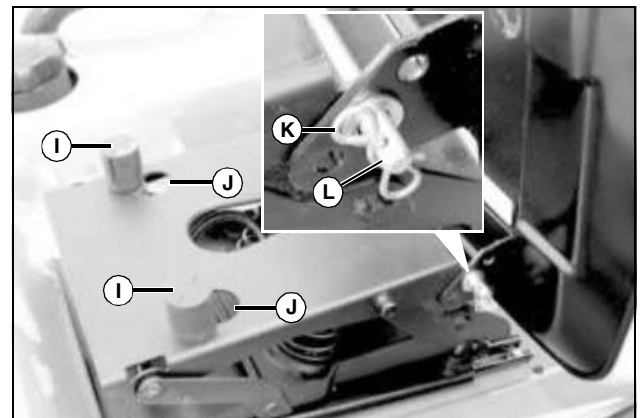

MX13550, MX13549

Rubber stops (I) may be reversed to position seat at two different heights. To change height - Slide stops out of retaining slots into larger holes (J), flip stops, and slide back into retaining slots to secure.

Seat bracket may be positioned at three different heights. To adjust - Remove locking clip (K) and seat rod (L).

Position seat bracket to align a different mounting hole with seat base, and install seat rod and locking clip to secure.

## Changing Seat Suspension Position on Slide Rails (X720, X724, X728, X729)

The seat suspension for models X720, X724, X728 and X729 has two sets of holes for mounting onto the slide rails. This provides an additional range of front / rear adjustment.

# OPERATING

to extend the range of the basic slide adjustment and the two slide rail to fenderdeck mounting positions.

1. Disconnect seat wire harness and remove seat.

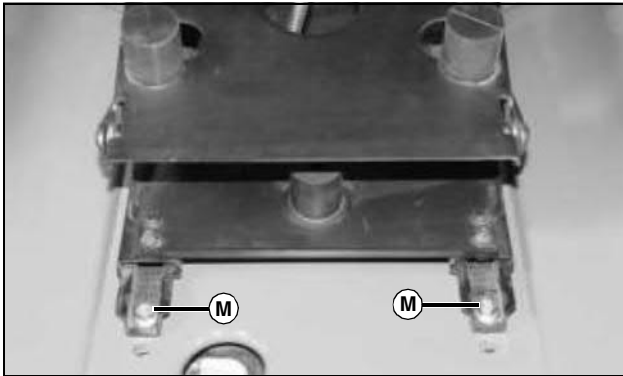

MX39544

2. Remove two bolts (M) in rear of slide rail.

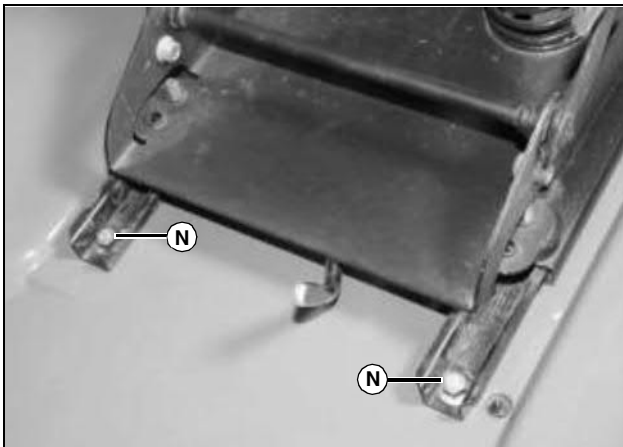

MX39545

3. Remove two bolts (N) in front of slide rail.
4. Remove seat suspension and slide rails from machine.

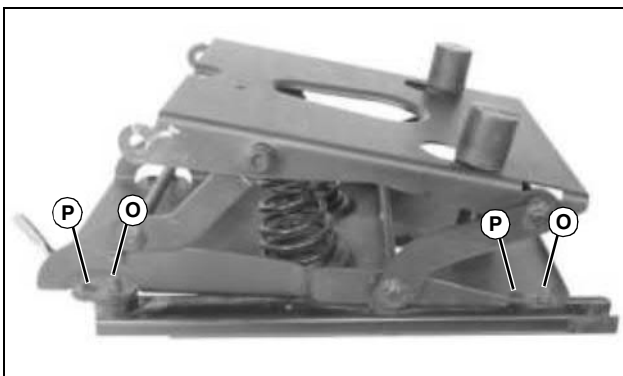

MX39543

5. Remove four bolts (O) securing seat suspension to slide rails. Use the slide adjustment as necessary to access the front and rear bolts from below.
6. Move slide rails and install bolts in forward mounting

holes (P). Use the slide adjustment as necessary to access the front and rear mounting holes from below.

7. Install seat suspension and slide rails on machine with four bolts, removed earlier.

## Adjusting Seat (Special Edition)

### Adjusting Seat Position

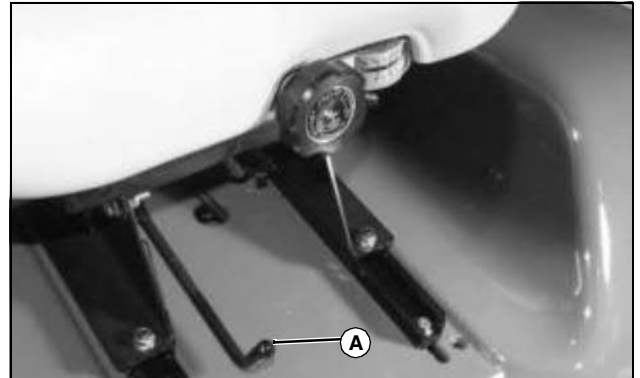

MX31913

1. Move seat adjustment lever (A) to the left.
2. Slide seat forward or backward to desired position.
3. Release lever.
4. Place the seat in the locked position.

### Adjusting Seat Suspension

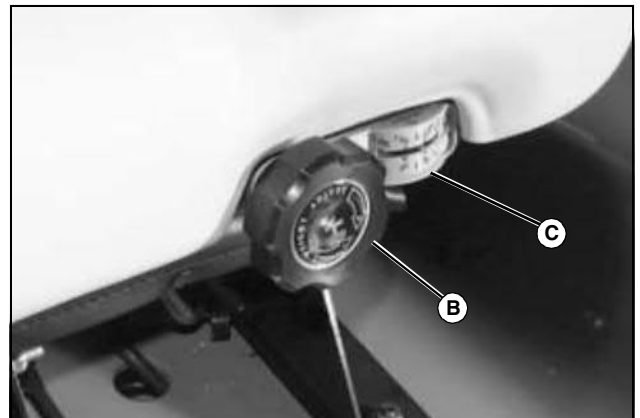

MX31913

Turn knob (B) to desired position per operator weight on gauge (C).



**Suggest:**

**If the above button click is invalid.**

**Please download this document**

**first, and then click the above link**

**to download the complete manual.**

**Thank you so much for reading**

# OPERATING

## Adjusting Seat Back

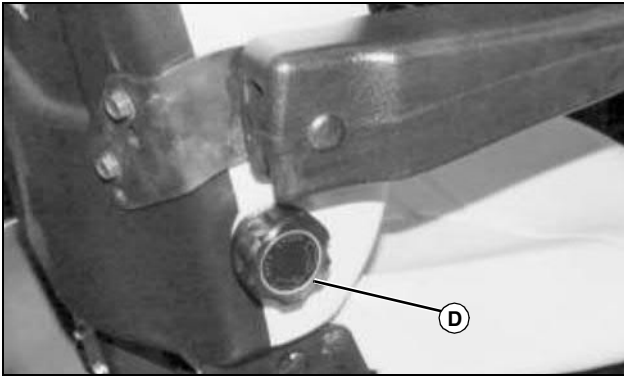

MX31914

**Picture Note:** The seat back adjustment knob is located on the right side of seat.

- Bring the seat back to a vertical position by turning the knob (D) to the right (clockwise).
- Turn the knob (D) to the left (counterclockwise) to recline the seat back slightly.

## Adjusting Lumbar Support

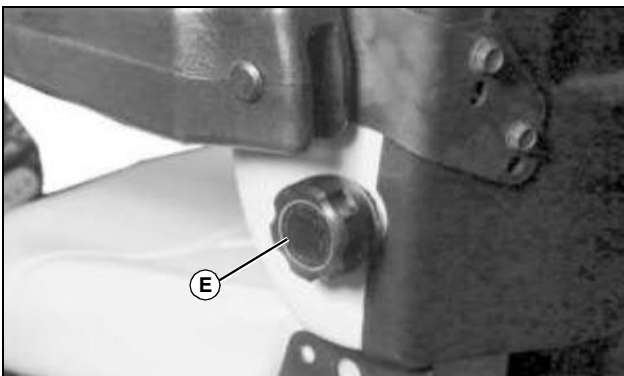

MX31915

**Picture Note:** The lumbar support knob is located on the left side of the seat.

- Turn the lumbar support knob to the left (counterclockwise) to decrease lumbar support.
- Turn the lumbar support knob (E) to the right (clockwise) to increase lumbar support.

## Adjusting Armrest

**NOTE:** If a John Deere Ultimate / X-Series certified cab ROPS is installed, before installing seat to machine you must raise armrest by using lower holes on adjustment bracket as shown below.

- To raise or lower armrest both sides:

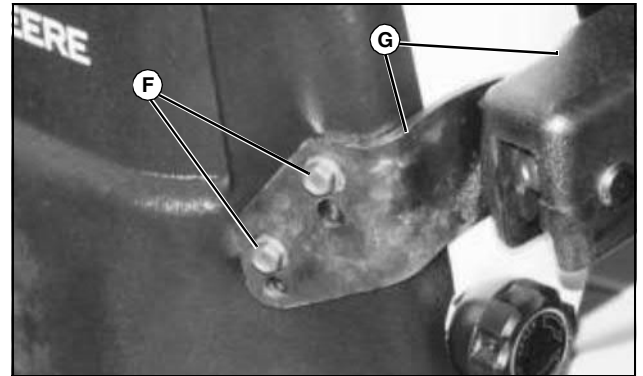

MX31916

- Remove two bolts (F) and raise armrest and bracket (G) to the other set of holes.
- Install bolts and tighten.

- To change the angle of the armrest both sides:

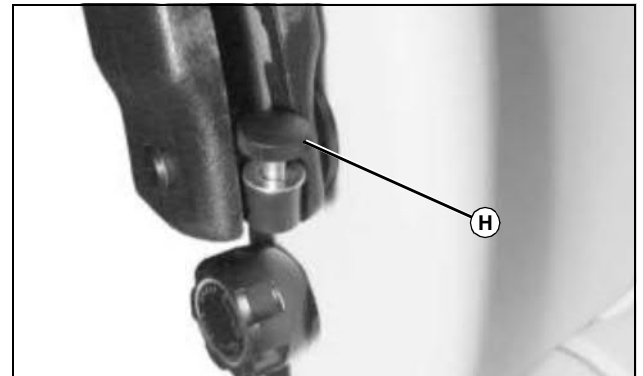

MX31817

- Lift armrest to reveal knob (H).
- Turn knob (H) to raise or lower knob height and change the angle of the armrest.

## Using Mower Height Control Knob



MX13567

Use mower height control knob (A) to adjust mower cutting height, and lock mower deck lift arms in raised position.

**<https://www.ebooklibonline.com>**

Hello dear friend!

Thank you very much for reading.

Enter the link into your browser.

The full manual is available for immediate download.

**<https://www.ebooklibonline.com>**