

JOHN DEERE
WORLDWIDE COMMERCIAL & CONSUMER
EQUIPMENT DIVISION

GATOR™ Utility Vehicle
TS

SN (050001-)

OMM159423 E9

OPERATOR'S MANUAL

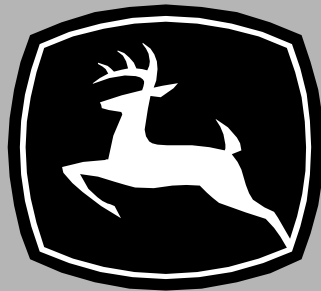

JOHN DEERE

⚠ WARNING: The Engine Exhaust from this product contains chemicals known to the State of California to cause cancer, birth defects or other reproductive harm.

California Proposition 65 Warning

North American Version
Litho in U.S.A.

INTRODUCTION

Thank You for Purchasing a John Deere Product

We appreciate having you as a customer and wish you many years of safe and satisfied use of your machine.

Using Your Operator's Manual

This manual is an important part of your machine and should remain with the machine when you sell it.

Reading your operator's manual will help you and others avoid personal injury or damage to the machine. Information given in this manual will provide the operator with the safest and most effective use of the machine. Knowing how to operate this machine safely and correctly will allow you to train others who may operate this machine.

If you have an attachment, use the safety and operating information in the attachment operator's manual along with the machine operator's manual to operate the attachment safely and correctly.

This manual and safety signs on your machine may also be available in other languages (see your authorized dealer to order).

Sections in your operator's manual are placed in a specific order to help you understand all the safety messages and learn the controls so you can operate this machine safely. You can also use this manual to answer any specific operating or servicing questions. A convenient index located at the end of this book will help you to find needed information quickly.

The machine shown in this manual may differ slightly from your machine, but will be similar enough to help you understand our instructions.

RIGHT-HAND and LEFT-HAND sides are determined by facing in the direction the machine will travel when going forward. When you see a broken line (-----), the item referred to is hidden from view.

Before delivering this machine, your dealer performed a predelivery inspection to ensure best performance.

Special Messages

Your manual contains special messages to bring attention to potential safety concerns, machine damage as well as helpful operating and servicing information. Please read all the information carefully to avoid injury and machine damage.



CAUTION: Avoid injury! This symbol and text highlight potential hazards or death to the operator or bystanders that may occur if the hazards or procedures are ignored.

IMPORTANT: Avoid damage! This text is used to tell the operator of actions or conditions that might result in damage to the machine.

NOTE: General information is given throughout the manual that may help the operator in the operation or service of the machine.

Attachments for Your Machine

There's a John Deere attachment or kit to make your new machine perform more tasks or be more versatile, whether your machine is a lawn tractor or compact utility tractor or a utility vehicle.

You can check out the entire line of attachments for your machine at JohnDeere.com or ask your John Deere dealer. From aerators to electric lift kits to tillers, there's a John Deere attachment or kit to fill every need.

PRODUCT IDENTIFICATION

Record Identification Numbers

TS - PIN (050001-)

If you need to contact an Authorized Service Center for information on servicing, always provide the product model and identification numbers.

You will need to locate the identification numbers for the product. Record the information in the spaces provided below.

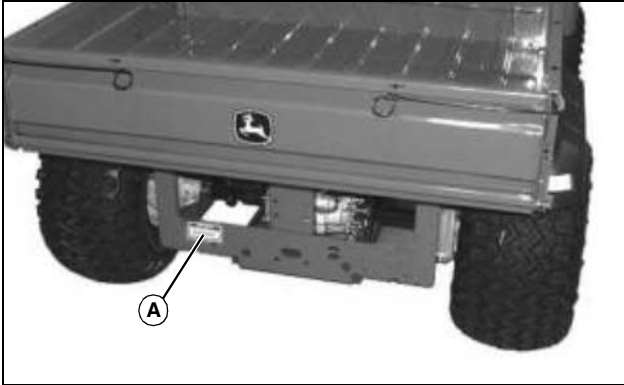

MX32931

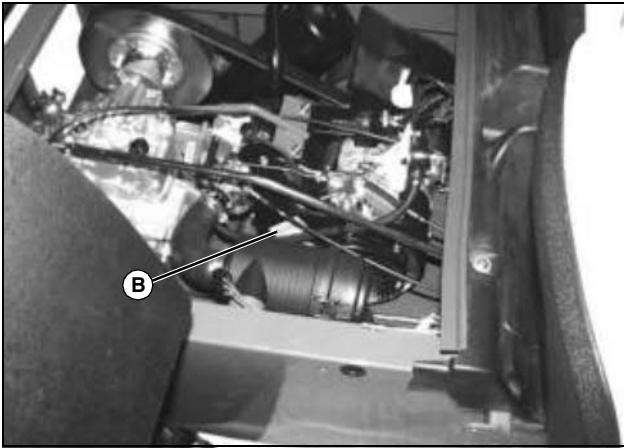

MX33443

DATE OF PURCHASE:

DEALER NAME:

DEALER PHONE:

PRODUCT IDENTIFICATION NUMBER (A):

ENGINE SERIAL NUMBER (B):

<https://www.ebooklibonline.com>

Hello dear friend!

Thank you very much for reading.

Enter the link into your browser.

The full manual is available for immediate download.

<https://www.ebooklibonline.com>

TABLE OF CONTENTS

Safety Labels	1
Safety Labels	2
Safety	5
Operating Controls	11
Operating	12
Replacement Parts	24
Service Intervals	25
Service Lubrication	26
Service Engine	27
Service Transmission	32
Service Electrical	35
Service Miscellaneous	39
Troubleshooting	43
Storage	46
Specifications	48
Warranty	51
Index	53

Original Instruction

All information, illustrations and specifications in this manual are based on the latest information at the time of publication. The right is reserved to make changes at any time without notice.

COPYRIGHT© 2009

Deere & Co.

John Deere Worldwide Commercial and Consumer Equipment Division

All rights reserved

Previous Editions

COPYRIGHT© 2009

OMM159423 E9 - English

SAFETY LABELS

Safety Label Location

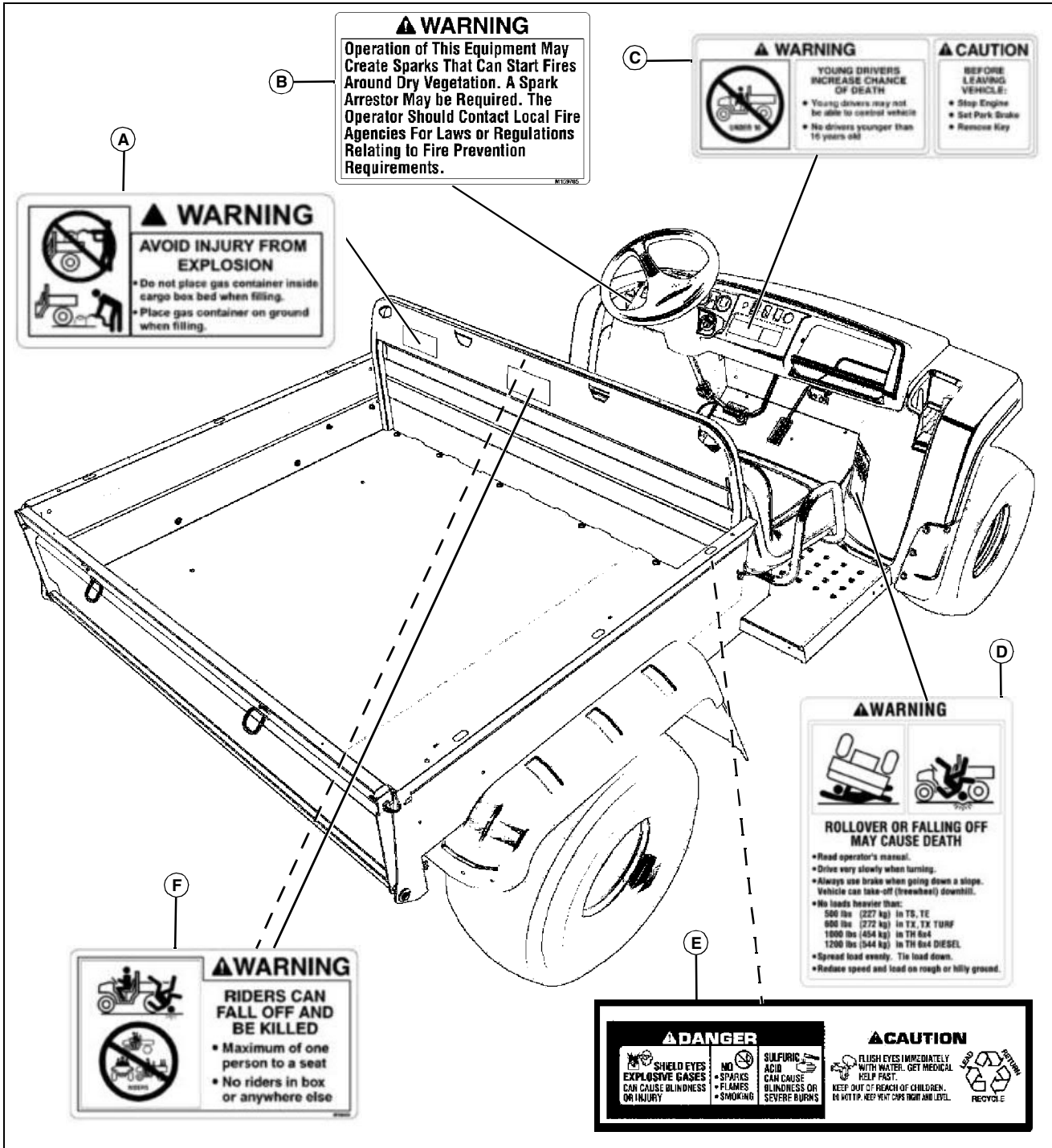

MX43394

D - WARNING - M154111

E - DANGER - M128699

F - WARNING - M150930

Picture Note: Use label number listed in table below to locate complete text of safety label message following this illustration.

A - WARNING - M152038

B - WARNING - M159705

C - WARNING - M150928

SAFETY LABELS



Understanding The Machine Safety Labels

The machine safety labels shown in this section are placed in important areas on your machine to draw attention to potential safety hazards.

On your machine safety labels, the words DANGER, WARNING, and CAUTION are used with this safety-alert symbol. DANGER identifies the most serious hazards.

The operator's manual also explains any potential safety hazards whenever necessary in special safety messages that are identified with the word, CAUTION, and the safety-alert symbol.

WARNING M154111

ROLLOVER OR FALLING OFF MAY CAUSE DEATH



M154111

- Read operator's manual.
- Drive very slowly when turning.
- Always use brake going down a slope. Vehicle can take-off (freewheel) downhill.
- No loads heavier than:
 - 500 lb (227 kg) in TS, TE
 - 600 lb (272 kg) in TX, TX TURF
 - 1000 lb (454 kg) in TH 6x4
 - 1200 lb (544 kg) in TH 6x4 DIESEL
- Spread load evenly. Tie load down.
- Reduce speed and load on rough or hilly ground.

CAUTION M150928

BEFORE LEAVING VEHICLE:



M150928

- Stop engine
- Set park brake
- Remove key

WARNING M150928

YOUNG DRIVERS INCREASE CHANCE OF DEATH

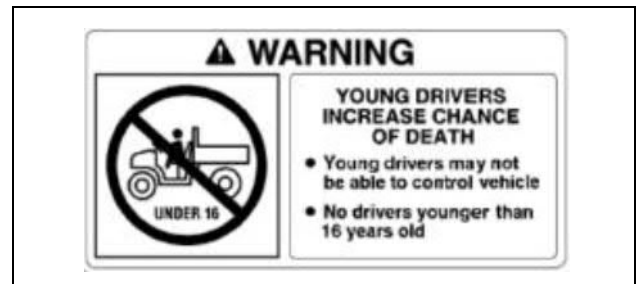

M150928

- Young drivers may not be able to control vehicle.
- No drivers younger than 16 years old.

WARNING

AVOID INJURY FROM EXPLOSION



M152038

- Do not place gas container inside cargo box bed when filling.

SAFETY LABELS

- Place gas container on ground when filling.

WARNING M150930

RIDERS CAN FALL OFF AND BE KILLED



M150930

- Maximum of one person to a seat
- No riders in box or anywhere else

DANGER M128699

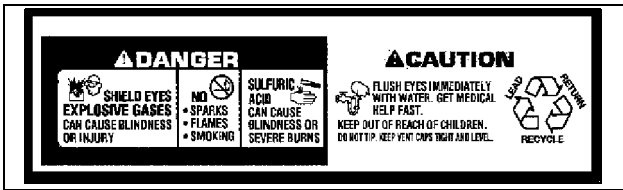

M128699

Picture Note: Located on battery

- Shield eyes, explosive gases can cause blindness or injury.
- No sparks, flames, smoking.
- Sulfuric acid can cause blindness or severe burns.
- Flush eyes immediately with water. Get medical help fast.
- Keep out of reach of children.
- Do not tip.
- Keep vent caps tight and level.

Emission Control System Certification Label

NOTE: Tampering with emission controls and components by unauthorized personnel may result in severe fines or penalties. Emission controls and components can only be adjusted by EPA and/or CARB authorized service centers. Contact your John Deere Commercial and Consumer Equipment Retailer concerning emission controls and component questions.

The presence of an emissions label signifies that the engine has been certified with the United States Environmental Protection Agency (EPA) and/or California Air Resources Board (CARB).

The emissions warranty applies only to those engines marketed by John Deere that have been certified by the EPA and/or CARB; and used in the United States and Canada in off-road mobile equipment.

Emission Compliance Period

If your engine has the emission compliance category listed on the emission control system certification or air index label, this indicates the number of operating hours for which the engine has been certified to meet EPA and/or CARB emission requirements. The following table provides the engine compliance period in hours associated with the category found on the certification label.

Agency	Category	Hours
EPA	C	250
EPA	B	500
EPA	A	1000
CARB	Moderate	125
CARB	Intermediate	250
CARB	Extended	500

SAE J2258 and ASME B56.8 Compliance

This vehicle conforms to SAE J2258.

With installation of the optional horn kit, this vehicle conforms to ASME B56.8.

Canadian Electromagnetic Compatibility (EMC) Compliance

This spark ignition system complies with Canadian ICES-002.

SAFETY LABELS

Warning M159705



M159705

Picture Note: This label is required and installed on machines sold in California. This label may also be installed on machines sold in other locations.

Operation of This Equipment May Create Sparks that Can Start Fires Around Dry Vegetation. A Spark Arrestor May be Required. The Operator Should Contact Local Fire Agencies For Laws or Regulations Relating to Fire Prevention Requirements.

SAFETY

Supervisor Safety Responsibilities

- Make sure all operators of this machine are thoroughly trained and are familiar with the operator's manual and understand the machine warning labels.
- Be sure to establish any special safety procedures for existing work conditions and train operators in those procedures.
- Supervisors, operators and mechanics should be familiar with and practice the safety standards that apply to this machine.

Operator Training Required

- Read the operator's manual and other training material. If the operator or mechanic cannot read English, it is the owner's responsibility to explain this material to them. This publication is available in other languages.
- Become familiar with the safe operation of the equipment, operator controls, and safety signs.
- All operators and mechanics should be trained. The owner of the machine is responsible for training the users.
- Never let children or untrained people operate or service the equipment. Local regulations may restrict the age of the operator.
- The owner/user can prevent and is responsible for accidents or injuries occurring to themselves, other people, or property.
- Operate the machine in an open, unobstructed area under the direction of an experienced operator.

Operating Safely

- Read, understand and follow all instructions in the operator's manual, on the machine and on the safety video before starting.
- Do not misuse the utility vehicle. It is a utility vehicle, not a recreation vehicle.
- The utility vehicle's tires are designed for off-road use only. Paved surfaces may seriously affect handling and control of the vehicle. If you must operate on a paved surface, travel slowly and do not make sudden turns or stops.
- Do not operate this vehicle on a frozen body of water. The vehicle could break through the ice, causing injury or even death.
- Go slowly and be extra careful when riding on snow-covered or ice-covered terrain.
- Slow down and be careful of traffic when operating near

or crossing roadways. Use care when approaching blind corners, shrubs, trees, or other objects that may obscure vision.

- The operator should always make sure that the passenger is aware of correct safety procedures while riding in the utility vehicle.
- Use the correct flags, lights, signs and reflectors on the vehicle to warn other drivers when operating near roadways. Make sure these features are clean and visible for 500 feet (152 m).
- The passenger should always use the hand holds.
- To avoid serious injury, always ensure that occupants have safely secured their seat belts prior to starting this vehicle.
- Horseplay or recreational riding can lead to accidents, severe bodily injury or death. Do not attempt stunts, jumps, or quick acceleration to raise front wheels off the ground. These actions can result in accidents or vehicle overturns.
- Sit on the center of the seat and keep both feet within the foot platform perimeter. Clean foot platform if dirty, and remove any debris from around foot controls.
- Check for debris in engine compartment, especially around brake linkage on each side of the transaxle.
- Always use both hands for steering.
- Know location of controls and how and what they operate.
- Never operate utility vehicle while standing.
- Never operate utility vehicle with the cargo box raised.
- Check brake action before beginning vehicle operation. Adjust or service the brakes as necessary.
- To provide adequate braking ability and traction, do not tow any attachment or loaded trailer unless the cargo box is fully loaded.
- Before shifting into reverse, always check for obstacles or people behind the machine.
- Always back slowly.
- Inspect vehicle before operating. Be sure hardware is tight. Repair or replace damaged, badly worn, or missing parts. Be sure guards and shields are in good condition and fastened in place. Make any necessary adjustments before operating.
- Do not leave vehicle unattended when it is running.
- Operate during daylight or with good artificial light and if you drive at night, use the lights.
- Do not operate vehicle if under the influence of alcohol or other drugs.
- Avoid sudden starts, stops, or turns.
- Always use a level turn-around area.

SAFETY

- Do not wear radio or music headphones. Safe service and operation require your full attention.

Using a Spark Arrestor

The engine in this machine is equipped with a spark arrestor muffler. The California Public Resources Code, section 4442.5 provides as follows:

No person shall sell, offer for sale, lease, or rent to any person any internal combustion engine subject to Section 4442 or 4443, and not subject to Section 13005 of the Health and Safety Code, unless the person provides a written notice to the purchaser or bailee, at the time of sale or at the time of entering into the lease or rental contract, stating that it is a violation of Section 4442 or 4443 to use or operate the engine on any forest-covered, brush-covered, or grass-covered land unless the engine is equipped with a spark arrestor, as defined in Section 4442, maintained in effective working order or the engine is constructed, equipped, and maintained for the prevention of fire pursuant to Section 4443. Cal. Pub. Res. Code 4442.5.

Other states or jurisdictions may have similar laws. A replacement spark arrestor for your machine is available from your authorized dealer. An installed spark arrestor must be maintained in good working order by the operator.

Parking Safely

1. Stop vehicle on a level surface, not on a slope.
2. Lock park brake.
3. Stop engine.
4. Remove key.
5. Before you leave the operator's seat, wait for engine and all moving parts to stop.
6. Disconnect the negative battery cable or remove the spark plug wire (for gasoline engines) before servicing the machine.

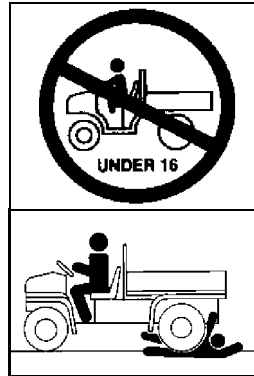

Protect Children and Prevent Accidents

- This utility vehicle should not be operated by anyone under the age of 16 years.
- Young drivers may not be physically able to control the machine or may not be mature enough to make safe driving decisions.
- Do not allow children to ride as a passenger in this vehicle. Children may not be able to sit safely in the passenger seat and use handholds properly.
- Passengers should always use the handholds while the vehicle is moving.
- The seat belt installed on utility vehicles with an Occupant Protective Structure (OPS) is not designed to restrain a child.
- Never carry passengers, especially children, in the cargo box area. Do not tow children in a cart or trailer.
- Never assume that children will remain where you last saw them. Stay alert to the presence of children.
- Before backing or turning, look behind and around the utility vehicle for children.
- Be alert at all times, drive forward and in reverse carefully. People, especially children, can move quickly into an area of operation.
- Use extra care when coming to blind corners, shrubs, trees, or other objects that may block vision.
- Misuse and recreational riding can lead to accidents, severe bodily injury or death.

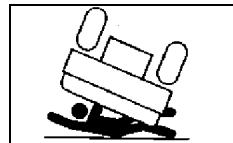

Avoid Excessive Speeds

- Always travel at a speed that is safe and proper for the terrain, visibility and operating conditions, and your experience operating the machine.
- Use caution when operating the machine in reverse. Use a slow speed and do not make sharp turns. Always look behind before backing.
- Never travel at excessive speeds on slopes, either going up or down. Use a slow speed and do not make sharp turns. Become experienced driving the machine on small slopes before driving on larger hills.

SAFETY

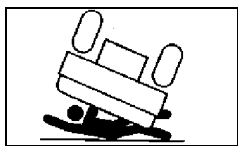

Avoid Tipping

Accidents resulting in serious injury or death can occur from tipping the utility vehicle. Observe the following practices to help prevent accidents:

- Do not misuse the utility vehicle. The utility vehicle is not designed for recreational riding.
- Drive very slowly when turning. Sharp turns could cause the utility vehicle to tip over.
- Reduce speed and exercise extreme caution on slopes or on rough ground.
- Do not overload vehicle and avoid shifting loads. Reduce load when operating over rough or hilly terrain.
- Do not stop or start suddenly when going uphill or downhill. Be especially cautious when changing direction on slopes.
- Stay alert for holes, rocks, and other hidden hazards in the terrain.
- Keep away from drop-offs, ditches, embankments, as well as ponds and other bodies of water. The machine could suddenly roll over if a wheel goes over the edge of a cliff or ditch or if the edge caves in.
- Keep front wheels straight at crest of hill or going over bumps.
- When descending a hill, remove foot from accelerator and apply brakes to reduce speed and maintain control.
- Do not make changes or modifications to the utility vehicle.

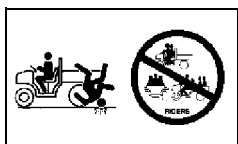

Keep Riders Off Vehicle

- Seating is provided for operator and one adult passenger.
 - Never allow riders in the cargo box or other areas where seats are not provided.
- Riders on vehicle are subject to injury such as being struck by foreign objects or being thrown off of the vehicle and severely injured or killed.
- Riders affect the operator's ability to control the vehicle as well as its center of gravity. Also, riders could obstruct the operator's view resulting in the vehicle being operated in an unsafe manner.

Transport Loads Safely

- Be sure load is evenly distributed in cargo box.
- Do not load above load guard.

- Securely anchor all loads in cargo box.
- Reduce cargo box load when operating on rough or hilly terrain.

Towing Loads Safely With Utility Vehicle

- To provide adequate braking ability and traction, weight of towed load (trailer plus cargo) must never exceed the vehicle payload (operator plus passenger plus cargo box load).
- Do not tow a load that exceeds the maximum allowable towing load for this vehicle, as specified in this operator's manual.
- Stopping distance increases with speed and weight of towed load. Travel slowly and allow extra time and distance to stop.
- Tow load at a speed slow enough to maintain control.
- Excessive towed load can cause loss of traction and loss of control on slopes. Reduce towed weight when operating on slopes.
- Never allow children or others in or on towed equipment.
- Use only approved hitches. Tow only with a machine that has a hitch designed for towing. Do not attach towed equipment except at the approved hitch point.
- Follow the manufacturer's recommendations for weight limits for towed equipment and towing on slopes.
- If you cannot back up a slope with a towed load, the slope is too steep to operate on with the towed load. Reduce the towed load or do not operate.
- Do not turn sharply. Use additional caution when turning or operating under adverse surface conditions. Use care when reversing.
- Do not shift to neutral and coast downhill.

Before Driving

1. Clean foot platform if dirty, and remove any debris from around foot controls. Sit on the center of seat and keep both feet inside foot platform perimeter.
2. Inspect utility vehicle for signs of wear or damage.
3. All safety equipment must be in good condition and fastened in place:
 - Lights.
 - Shields.
 - Safety start devices.
4. Before moving, check around utility vehicle, be sure no

SAFETY

one is near it.

5. Inspect mechanical condition of your vehicle before each use to minimize chance of injury or being stranded. Remember, you can ride farther in an hour than you can walk in a day.

Be sure to check condition of tires and wheels, wheel hardware torque, and maintain proper tire pressure.

6. Securely anchor all loads.

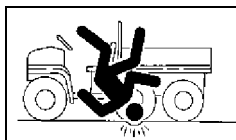

Driving On Rough Terrain

- Use existing trails. Avoid terrain such as dangerous slopes and impassable swamps. Watch carefully for bumps, holes, ruts, loose terrain,

or other obstacles.

- Look ahead at terrain. Know what is coming and be prepared to react. Be alert for hazards.
- Keep front wheels straight at crest of hill or going over bumps.
- Reduce speed according to trail, terrain, and visibility conditions.
- The passenger should always use the hand holds.

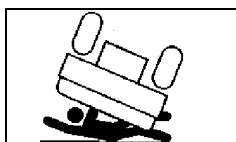

Climbing Or Descending A Hill

- Always use the brakes when going down slopes, the utility vehicle can speed up (freewheel) going down a

slope. Engine or clutch braking effect is minimal.

- Balance loads evenly and secure them. Braking could shift the load and affect vehicle stability.
- Sit on center of seat and keep both feet within foot platform.
- Never drive past the limit of visibility. Slow down near crest of hill until getting a clear view of the other side. Never go over the top of any hill at a high speed. An obstacle, sharp drop, another vehicle or person, could be on the other side of the hill.
- Keep front wheels straight at crest of hill or going over bumps.
- Do not stop or start suddenly when going uphill or downhill. Be especially cautious when changing direction on slopes.
- If vehicle stops or loses power going up a hill, lock park brake to hold vehicle on slope. Maintain direction of travel and release brake slowly. Back straight down hill slowly

while maintaining control. Do not turn vehicle sideways. Vehicle is more stable in a straight forward or rearward position.

- When descending a hill, remove foot from accelerator and apply brakes to reduce speed and maintain control.

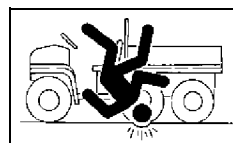

Driving Across Slopes

- Reduce speed and use caution on slopes and in sharp turns.

- Stay alert for holes, rocks and other hidden hazards in the terrain.

- When riding on soft terrain, turn front wheels slightly uphill to keep utility vehicle on a straight line across the hill.
- If utility vehicle begins to tip, turn front wheel downhill to gain control before proceeding.

Riding Through Water

- Avoid water whenever possible. If drive belt becomes wet, slippage will occur and vehicle will lose power.
- Never cross any body of water where depth may be unknown to the operator. As an operational guideline, deep water is considered anything in excess of 152 mm (6 in.) in depth. Tires may float, making it difficult to maintain control.
- Choose a course within the waterway where both banks have a gradual incline. Cross at a point known to be safe.
- Proceed at a slow steady speed to avoid submerged obstacles and slippery rocks.
- Avoid water crossings where the operation of a utility vehicle may cause damage to waterway beds or erode waterway shoreline.
- Never operate this vehicle in fast-moving water.
- Stopping ability of vehicles with external disk brakes may be affected after driving through water. If necessary, apply brakes several times to dry them out.

Checking Wheel Hardware

- A serious accident could occur causing serious injury if wheel hardware is not tight.
- Check wheel hardware tightness often during the first 100 hours of operation.
- Wheel hardware must be tightened to specified torque using the proper procedure anytime it is loosened.

SAFETY

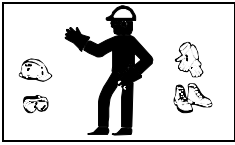

Wear Appropriate Clothing

- Wear close fitting clothing and safety equipment appropriate for the job.

- Certain operating conditions may dictate that the operator and any passenger wear appropriate safety equipment while operating the vehicle. Be prepared for any existing and potential conditions before operating machine.
- Local safety or insurance regulations may require additional safety equipment such as eye protection or a hard hat.
- Always wear substantial footwear and long trousers. Do not operate the equipment when barefoot or wearing open sandals.



Practice Safe Maintenance

- Only qualified, trained adults should service this machine.

- Understand service procedure before doing work. Keep area clean and dry.
- Never lubricate, service, or adjust machine while it is moving. Keep safety devices in place and in working condition.
- Keep hands, feet, clothing, jewelry, and long hair away from any moving parts, to prevent them from getting caught.
- Disconnect battery(ies) or remove spark plug wire (for gasoline engines) before making any repairs.
- Keep all nuts and bolts tightened.
- Securely support any machine elements that must be raised for service work. Lock service latches before working on machine with raised attachments.
- Never run engine unless park brake is locked.
- Keep all parts in good condition and properly installed. Fix damage immediately. Replace worn or broken parts. Replace all worn or damaged safety and instruction decals.
- To prevent fires, remove any buildup of grease, oil, or debris from the machine, especially the engine.
- Do not modify machine or safety devices. Unauthorized modifications may impair its function and safety.
- Do not wear radio or music headphones while servicing the machine. Safe service requires your full attention.
- Disconnect battery ground cable(s) (-) on the machine or remove attachment from machine before welding on the machine.

Prevent Fires

- Remove grass and debris from engine compartment and muffler area, before and after operating machine.
- Always shut off fuel when storing or transporting machine, if the machine has a fuel shutoff.
- Do not store machine near an open flame or source of ignition, such as a water heater or furnace.
- Check fuel lines, tank, cap, and fittings frequently for cracks or leaks. Replace if necessary.

Do Not Modify Machine

Do not make any unauthorized modifications to the machine in anyway.

Modifications can result in making the machine unstable, increasing the possibility of rollover causing severe bodily injury or death.



Tire Safety

Explosive separation of a tire and rim parts can cause serious injury or death:

- Do not attempt to mount a tire without the proper equipment and experience to perform the job.
- Always maintain the correct tire pressure. Do not inflate the tires above the recommended pressure. Never weld or heat a wheel and tire assembly. The heat can cause an increase in air pressure resulting in a tire explosion. Welding can structurally weaken or deform the wheel.
- When inflating tires, use a clip-on chuck and extension hose long enough to allow you to stand to one side and NOT in front of or over the tire assembly.
- Check tires for low pressure, cuts, bubbles, damaged rims or missing lug bolts and nuts.

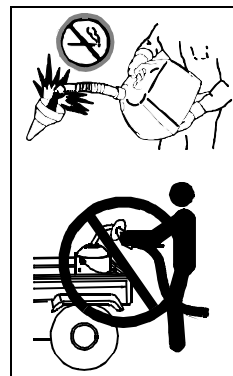

Handling Fuel Safely

To avoid personal injury or property damage, use extreme care in handling fuel. Fuel is extremely flammable and fuel vapors are explosive:

- Extinguish all cigarettes, cigars, pipes, and other sources of ignition.
- Use only an approved fuel container. Use only non-metal,

SAFETY

portable fuel containers approved by the Underwriter's Laboratory (U.L.) or the American Society for Testing & Materials (ASTM). If using a funnel, make sure it is plastic and has no screen or filter.

- Never remove the fuel tank cap or add fuel with the engine running. Allow engine to cool before refueling.
- Never add fuel to or drain fuel from the machine indoors. Move machine outdoors and provide adequate ventilation.
- Clean up spilled fuel immediately. If fuel is spilled on clothing, change clothing immediately. If fuel is spilled near machine, do not attempt to start the engine but move the machine away from the area of spillage. Avoid creating any source of ignition until fuel vapors have dissipated.
- Never store the machine or fuel container where there is an open flame, spark, or pilot light such as on a water heater or other appliance.
- Prevent fire and explosion caused by static electric discharge. Static electric discharge can ignite fuel vapors in an ungrounded fuel container.
- Never fill containers inside a vehicle or on a truck or trailer bed with a plastic liner. Always place containers on the ground away from your vehicle before fueling.
- Remove fuel-powered equipment from the truck or trailer and refuel it on the ground. If this is not possible, then refuel such equipment with a portable container, rather than from a fuel dispenser nozzle.
- Keep the nozzle in contact with the rim of the fuel tank or container opening at all times until the fueling is complete. Do not use a nozzle lock-open device.
- Never overfill fuel tank. Replace fuel tank cap and tighten securely.
- Replace all fuel container caps securely after use.
- For gasoline engines, do not use gas with methanol. Methanol is harmful to your health and to the environment.

Handling Waste Product and Chemicals

Waste products, such as, used oil, fuel, coolant, brake fluid, and batteries, can harm the environment and people:

- Do not use beverage containers for waste fluids - someone may drink from them.
- See your local Recycling Center or authorized dealer to learn how to recycle or get rid of waste products.
- A Material Safety Data Sheet (MSDS) provides specific details on chemical products: physical and health hazards, safety procedures, and emergency response techniques. The seller of the chemical products used with your machine is responsible for providing the MSDS for that product.



Suggest:

If the above button click is invalid.

Please download this document

first, and then click the above link

to download the complete manual.

Thank you so much for reading

OPERATING CONTROLS

Operator Station Controls

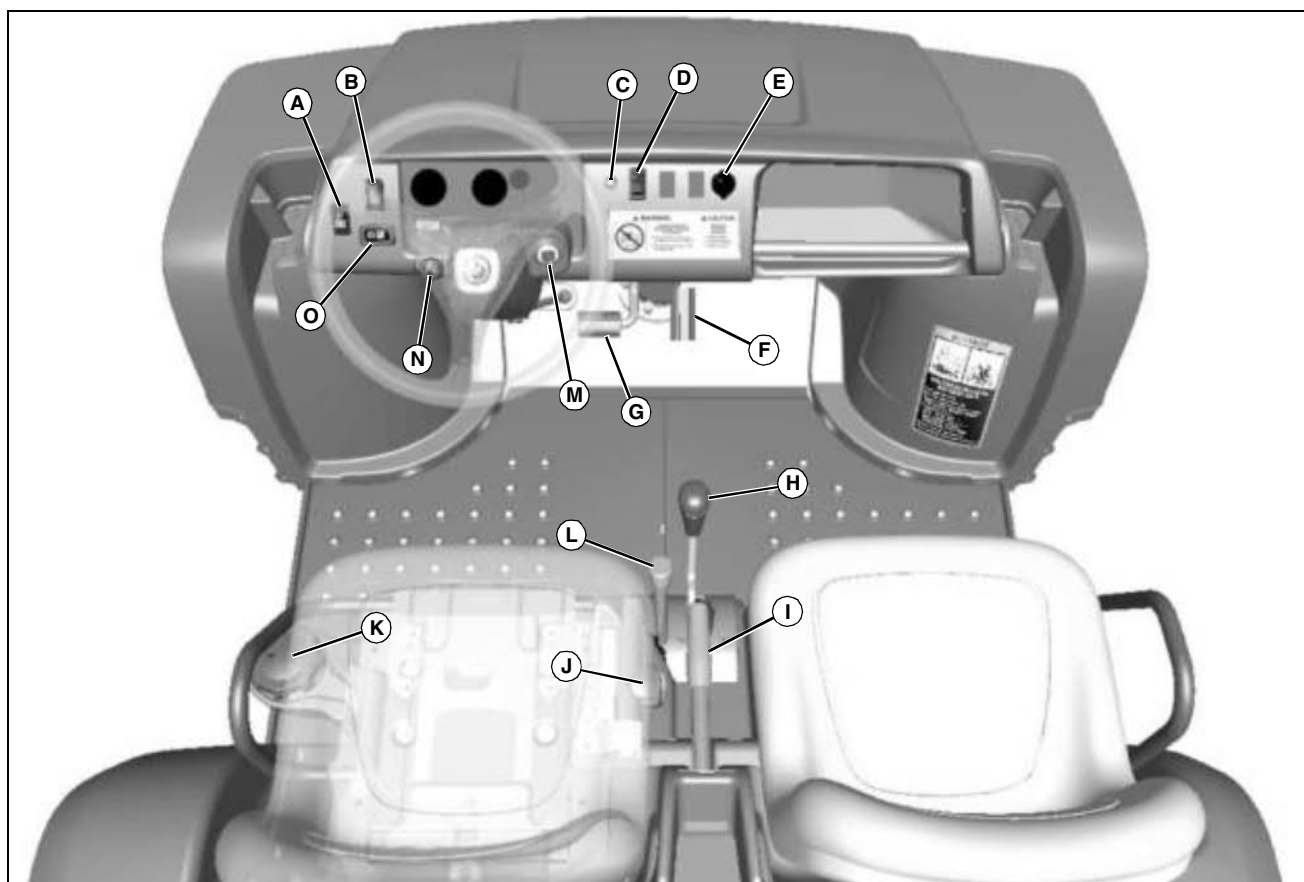

MX40030a

- A - Cargo Box Power Lift Switch***
- B - Hazard Light Switch***
- C - Horn Switch***
- D - Headlight Switch**
- E - 12 VDC Accessory Outlet**
- F - Accelerator Pedal**
- G - Brake Pedal**
- H - Gear Shift Lever**
- I - Park Brake Lever**
- J - Fuel Gauge**
- K - Fuel Tank Cap**
- L - Traction Assis (Differential Lock) Lever**
- M - Key Switch**
- N - Choke Knob**
- O - Turn Signal Switch***

*Optional Equipment

<https://www.ebooklibonline.com>

Hello dear friend!

Thank you very much for reading.

Enter the link into your browser.

The full manual is available for immediate download.

<https://www.ebooklibonline.com>