

JOHN DEERE
AG & TURF DIVISION

**John Deere Select Series
X500 Multi-Terrain Series Tractors**

OMM167794 H2

OPERATOR'S MANUAL



JOHN DEERE

Export Version
Printed in U.S.A.

Introduction

Thank You for Purchasing a John Deere Product

We appreciate having you as a customer and wish you many years of safe and satisfied use of your machine.

Using Your Operator's Manual

This manual is an important part of your machine and should remain with the machine when you sell it.

Reading your operator's manual will help you and others avoid personal injury or damage to the machine. Information given in this manual will provide the operator with the safest and most effective use of the machine. Knowing how to operate this machine safely and correctly will allow you to train others who may operate this machine.

If you have an attachment, use the safety and operating information in the attachment operator's manual along with the machine operator's manual to operate the attachment safely and correctly.

This manual and safety signs on your machine may also be available in other languages (see your authorized dealer to order).

Sections in your operator's manual are placed in a specific order to help you understand all the safety messages and learn the controls so you can operate this machine safely. You can also use this manual to answer any specific operating or servicing questions. A convenient index located at the end of this book will help you to find needed information quickly.

The machine shown in this manual may differ slightly from your machine, but will be similar enough to help you understand our instructions.

RIGHT-HAND and LEFT-HAND sides are determined by facing in the direction the machine will travel when going forward. When you see a broken line (-----), the item referred to is hidden from view.

Before delivering this machine, your dealer performed a predelivery inspection to ensure best performance.

Machine Use

This machine is designed solely for use in customary lawn mowing operations, for park and amenity area maintenance and for winter work. Use in any other way is considered as contrary to the intended use.

This machine is not intended for use in forestry operations. The operator station does not provide adequate protection to the occupants in that environment.

The cab available from the manufacturer is not designed to

provide adequate protection from hazardous substances. The operator must wear appropriate personal protection equipment.

The manufacturer accepts no liability for damage or injury resulting from this misuse, and these risks must be borne solely by the user. Compliance with and strict adherence to the conditions of operation, service and repair as specified by the manufacturer also constitute essential elements for the intended use.

This machine should be operated, serviced and repaired only by persons familiar with all its particular characteristics and acquainted with the relevant safety rules (accident prevention). The accident prevention regulations, all other generally recognized regulations on safety and occupational medicine and the road traffic regulations must be observed at all times.

Setting fuel delivery beyond published factory specifications or otherwise overpowering will result in loss of warranty protection for this machine.

Any arbitrary modifications carried out on this machine will relieve the manufacturer of all liability for any resulting damage or injury.

Special Messages

Your manual contains special messages to bring attention to potential safety concerns, machine damage as well as helpful operating and servicing information. Please read all the information carefully to avoid injury and machine damage.



CAUTION: Avoid injury! This symbol and text highlight potential hazards or death to the operator or bystanders that may occur if the hazards or procedures are ignored.

IMPORTANT: Avoid damage! This text is used to tell the operator of actions or conditions that might result in damage to the machine.

NOTE: General information is given throughout the manual that may help the operator in the operation or service of the machine.

Product Identification

Record Identification Numbers

John Deere Select Series™ - X500 Multi-Terrain™ Tractors

PIN (080001-)

If you need to contact an Authorized Service Center for information on servicing, always provide the product model and identification numbers.

You will need to locate the model and serial number for the machine and for the engine of your machine and record the information in the spaces provided below.

DATE OF PURCHASE:

DEALER NAME:

DEALER PHONE:

Picture Note: X500, X530, and X534 engine serial number location shown.

PRODUCT IDENTIFICATION NUMBER (A):

ENGINE SERIAL NUMBER (B):

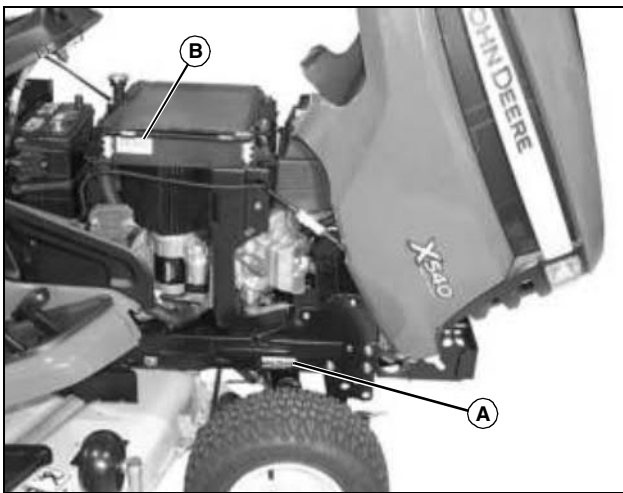

MX36619

Picture Note: X540 engine serial number shown.

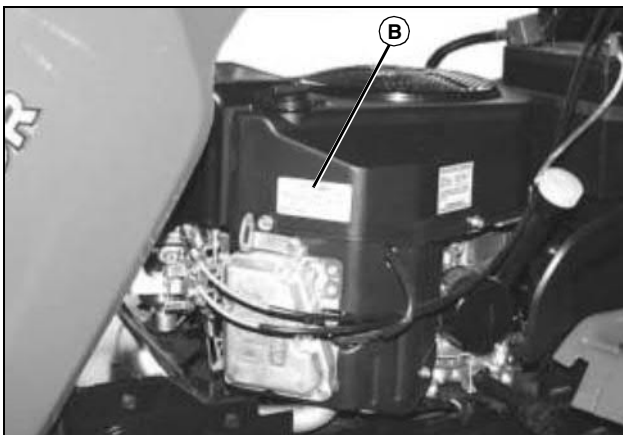

MX43928

<https://www.ebooklibonline.com>

Hello dear friend!

Thank you very much for reading.

Enter the link into your browser.

The full manual is available for immediate download.

<https://www.ebooklibonline.com>

Table of Contents

Safety Labels	1
Safety	5
Machine Cleanout.....	13
Operating - Controls	16
Operating.....	17
Replacement Parts	32
Service Intervals	33
Service Lubrication.....	34
Service Engine	36
Service Transmission	46
Service Mower.....	49
Service Electrical.....	56
Service Miscellaneous.....	59
Troubleshooting	64
Storage	68
Assembly	70
Specifications	72
Declaration of Conformity	77
Declaration of Conformity	79
Index.....	81

Original Instruction

All information, illustrations and specifications in this manual are based on the latest information at the time of publication. The right is reserved to make changes at any time without notice.

COPYRIGHT© 2012

Deere & Co.

John Deere Ag & Turf Division

All rights reserved

Previous Editions

COPYRIGHT© 2007, 2008, 2009, 2010,
2011

OMM167794 H2 - English

Safety Labels

Pictorial Safety Label Location

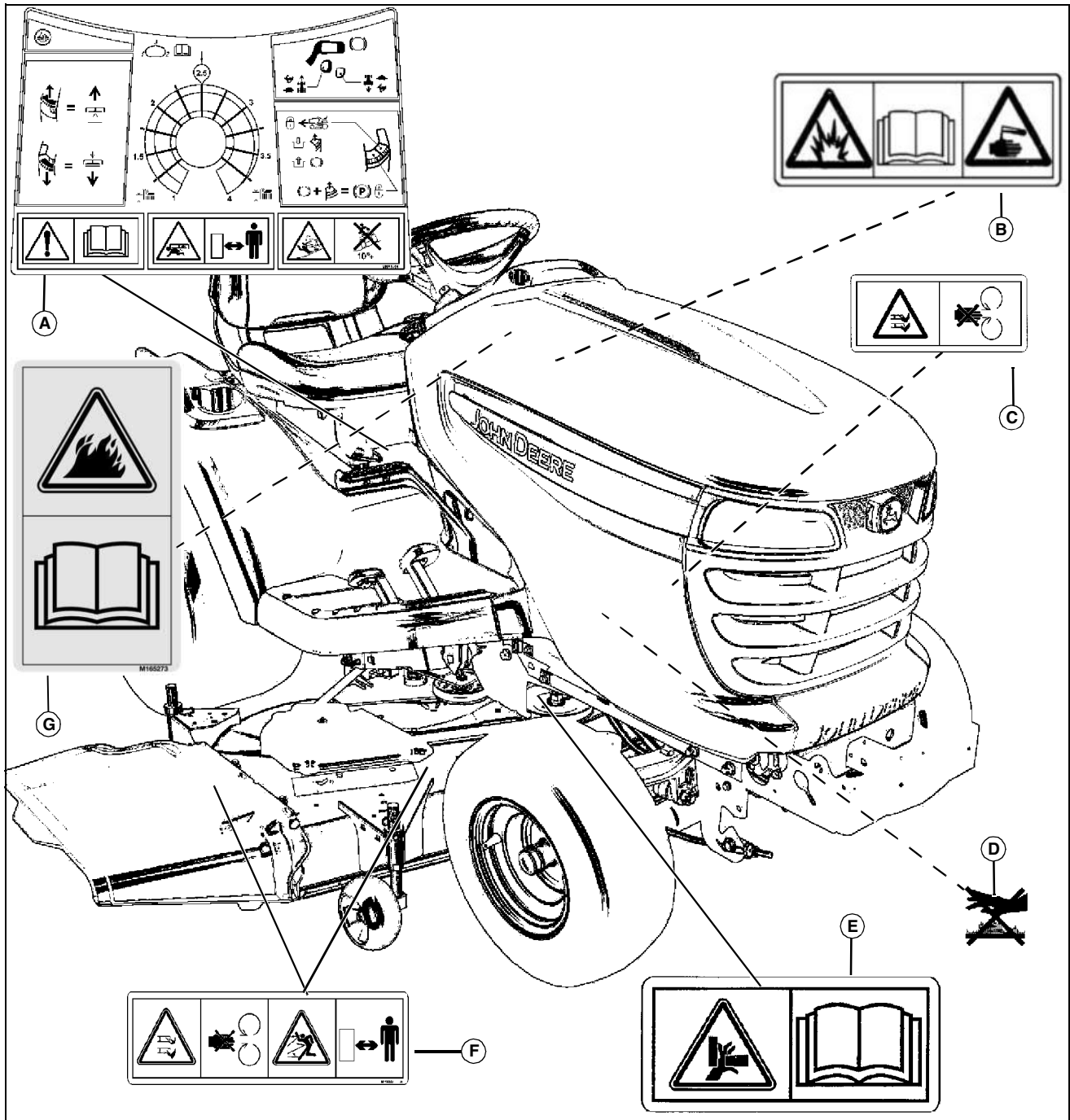

MX42022

Picture Note: Use label number listed in table below to locate complete text of safety label message following this illustration.

Pictorial labels are required for certain parts of the world. Your machine may not be equipped with these labels.

A - DANGER M168854

B - DANGER M133159 (ON BATTERY)

C - WARNING M118041

D - CAUTION (MOLDED INTO MUFFLER)

E - WARNING M133166

F - DANGER M118040

G - CAUTION M165273

Safety Labels



Pictorial Safety Signs

At several important places on this machine safety signs are affixed intended to signify potential danger. The hazard is identified by a pictorial in a warning triangle. An adjacent pictorial provides information how to avoid personal injury. These safety signs, their placement on the machine and a brief explanatory text are shown in this Safety section.

There can be additional safety information contained on parts and components sourced from suppliers that is not reproduced in this operator's manual.

M168854 Warning

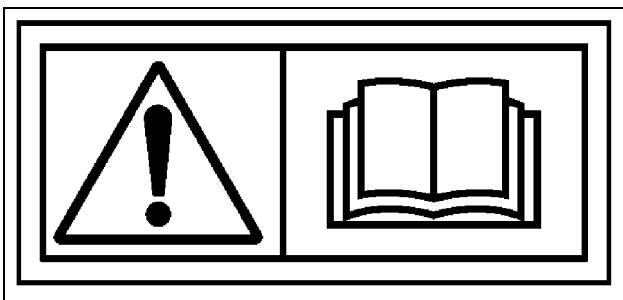

M168854

- This operator's manual contains important information necessary for safe machine operation
- Carefully read operator's manual before operating machine. Observe all safety rules to avoid accidents.

M168854 Warning

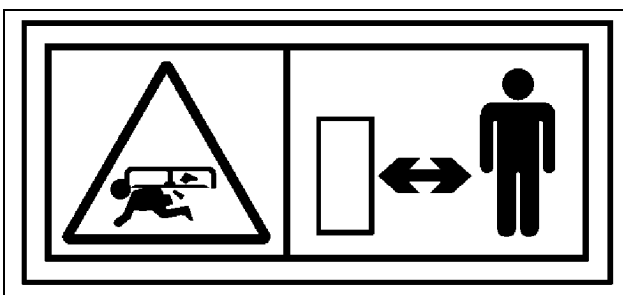

M168854

- Make sure children stay clear of mower at all times when the engine is running.
- Stay a safe distance from the machine.

M168854 Warning

AVOID INJURY FROM TIPPING

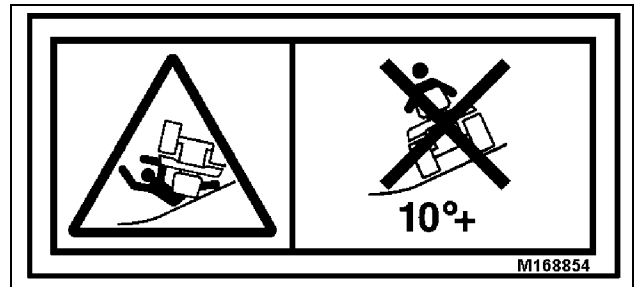

M168854

- Do not drive where tractor could slip, tip, or rollover.
- In some configurations, do not drive or operate on a slope of more than 10 degrees.
- Refer to the Operating on Slopes section for more information.

WARNING M133159

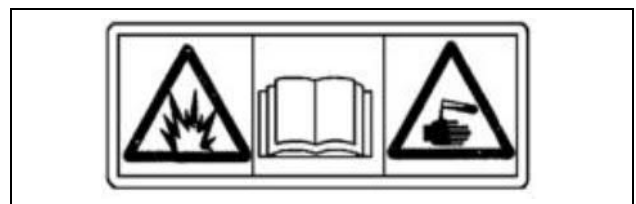

M133159

Avoid Injury From Battery Gases and Acids

- Batteries contain explosive gases and sulfuric acid. Use extreme caution when handling battery.
- Read operator's manual for all safety information before handling battery.
- Use extreme caution when handling battery.

Warning Hot Surface

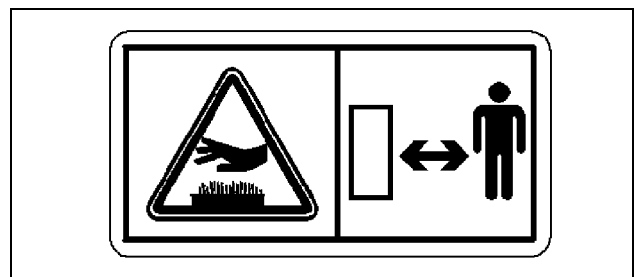

M150678

- Stay clear of hot surfaces.

Safety Labels

- Stay a safe distance from machine.

Avoid Injury From Rotating Blades - M118041

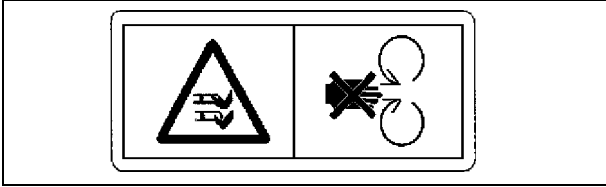

M118041

- Do not put hands or feet under or into mower when engine is running.
- Do not operate mower without discharge chute or entire grass catcher in place.

Avoid Injury From Rotating Blades and Thrown Objects - M118040

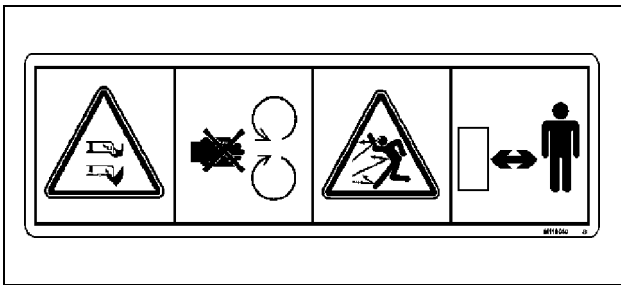

M118040

- Do not put hands or feet under or into mower when engine is running.
- Do not operate mower without discharge chute or entire grass catcher in place.
- Before mowing, clear area of objects that may be thrown by blade.
- Stay clear while engine is running.

Avoid Injury From Getting Caught in Belt - M136436

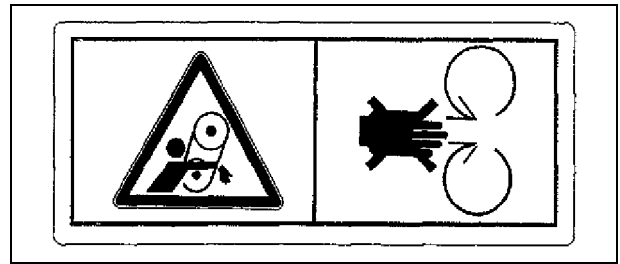

M136436

- Stay clear of belts.
- Do not operate mower without shields in place.

Drawbar Load

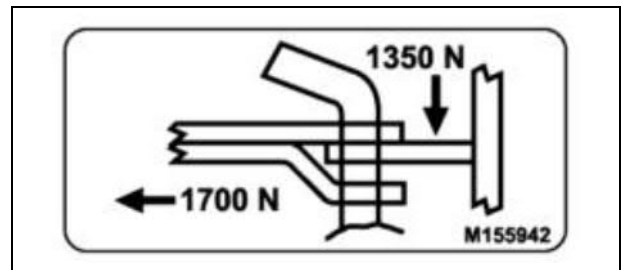

M155942

Do not exceed recommended drawbar loads stated on label.

- Horizontal 1700 N (382 lb)
- Vertical 1350 N (303 lb)

Safety Labels

Prevent Equipment Fires

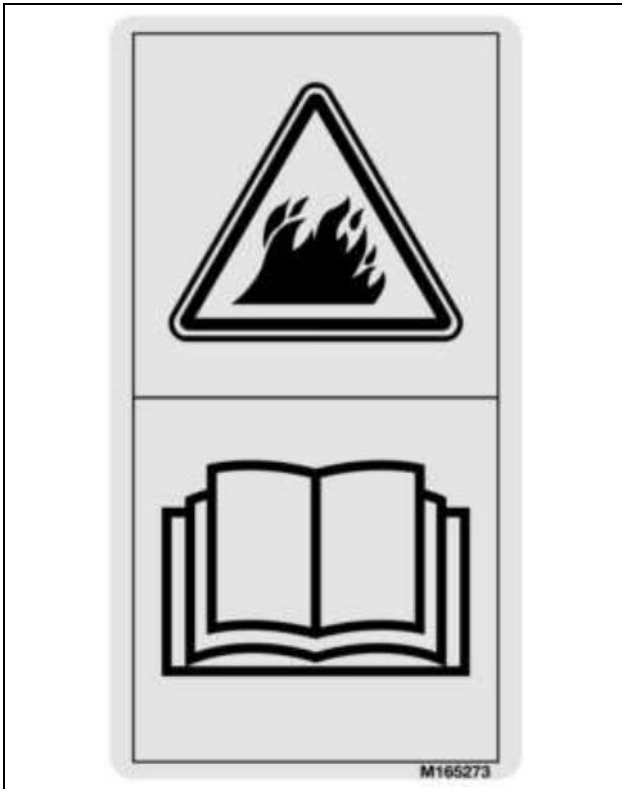

M165273

- Clean and inspect the entire machine.
- Carefully read Operator's Manual Machine Cleanout section for details.

Avoid Injury From Loaded Spring

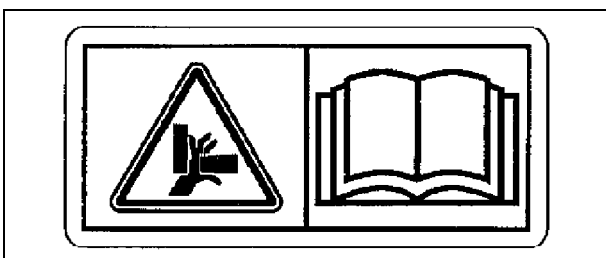

M133166

- Keep fingers and hands away from pinch point.
- To avoid injury from loaded spring, read Operator's Manual before changing attachment.

CE Certification, Specification and Sound Label

Model X534

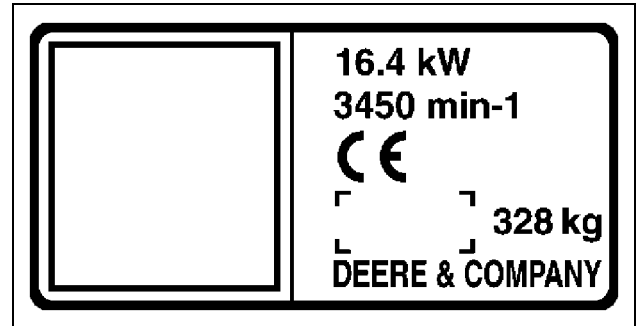

M163355

Model X540

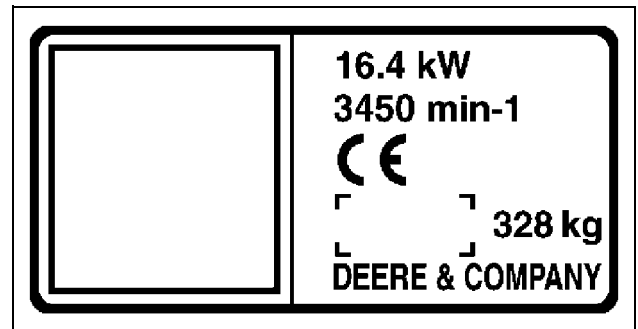

M163356

- This label on your machine indicates nominal power, engine speed, and mass. It satisfies marking requirements for European Directive 98/37/EC (89/392/EEC) and 2000/14/EC standards.

Safety

Training

- Read the instructions carefully. Be familiar with the controls and the proper use of the equipment.
- Never allow children or people unfamiliar with these instructions to use the lawnmower. Local regulations can restrict the age of the operator.
- Never mow while people, especially children, or pets are nearby.
- Keep in mind that the operator or user is responsible for accidents or hazards occurring to other people or their property.
- Do not carry passengers.
- All drivers should seek and obtain professional and practical instruction. Such instruction should emphasize:
 - the need for care and concentration when working with ride-on machines.
 - control of a ride-on machine sliding on a slope will not be regained by the application of the brake.
- The main reasons for loss of control are:
 - insufficient wheel grip;
 - being driven too fast;
 - inadequate braking;
 - the type of machine is unsuitable for its task;
 - lack of awareness of the effect of ground conditions, especially slopes;
 - incorrect hitching and load distribution.

Preparation

- While mowing, always wear substantial footwear and long trousers. Do not operate the equipment when barefoot or wearing open sandals.
- Thoroughly inspect the area where the equipment is to be used and remove all objects which can be thrown by the machine.
- **WARNING-Fuel is highly flammable.**
 - store fuel in containers specifically designed for this purpose.
 - refuel outdoors only and do not smoke while refueling.
 - add fuel before starting the engine. Never remove the cap of the fuel tank or add fuel while the engine is running or when the engine is hot.
 - if fuel is spilled, do not attempt to start the engine but move the machine away from the area of spillage and

avoid creating any source of ignition until fuel vapors have dissipated.

- replace all fuel tank and container caps securely.
- Replace faulty silencers.
- Before using, always visually inspect to see that the blades, blade bolts and cutter assembly are not worn or damaged. Replace worn or damaged blades and bolts in sets to preserve balance.
- On multi-bladed machines, take care as rotating one blade can cause other blades to rotate.

Operation

- Do not operate the engine in a confined space where dangerous carbon monoxide fumes can collect.
- Mow only in daylight or in good artificial light.
- Before attempting to start the engine, disengage all blade attachment clutches and shift into neutral.
- Do not use on slopes of degrees more than recommended by the manufacturer.
- Remember there is no such thing as a safe slope. Travel on grass slopes requires particular care. To guard against overturning:
 - do not stop or start suddenly when going up or downhill;
 - engage clutch slowly, always keep machine in gear, especially when traveling downhill;
 - machine speeds should be kept low on slopes and during tight turns;
 - stay alert for humps and hollows and other hidden hazards;
 - never mow across the face of a slope, unless the machine is designed for this purpose.
- Use care when pulling loads or using heavy equipment:
 - use only approved drawbar hitch points;
 - limit loads to those you can safely control;
 - do not turn sharply. Use care when reversing;
 - use counterweights or wheel weights when suggested in the operator's manual.
- Watch out for traffic when crossing or near roadways.
- Stop the blades from rotating before crossing surfaces other than grass.
- Never direct discharge of material toward bystanders nor allow anyone near the machine while in operation.
- Never operate the machine with defective guards, or

Safety

without safety protective devices in place.

- Do not change the engine governor settings or overspeed the engine. Operating the engine at excessive speed can increase the hazard of personal injury.
- Before leaving the operator's position:
 - disengage the drive to any attachments and lower them;
 - change into neutral and lock the parking brake;
 - stop the engine and remove the key.
- Disengage drive to attachments, stop the engine, disconnect the spark plug wires and remove the ignition key:
 - before clearing blockages or unclogging chute;
 - before checking, cleaning, or working on the machine;
 - after striking a foreign object. Inspect the machine for damage and make repairs before restarting and operating the equipment;
 - if the machine starts to vibrate abnormally (check immediately).
- Disengage drive to attachments when transporting or not in use.
- Stop the engine and disengage drive to attachment:
 - before refueling;
 - before removing the grass catcher;
 - before making height adjustment unless adjustment can be made from the operator's position.
- Reduce the throttle setting during run-out and, if the engine is provided with a shut-off valve, turn the fuel off at the conclusion of mowing.
- Read, understand and follow all instructions in the manual and on the machine before starting.
- Inspect machine before you operate. Repair or replace damaged, badly worn, or missing parts. Make any necessary adjustments before you operate.
- Be sure all drives are in neutral and parking brake is locked before starting engine. Only start engine from the operator's position.
- Do not operate mower without discharge chute or entire grass catcher in place. Never operate with the discharge deflector raised, removed, or altered, unless using a grass catcher.
- Check brake action before you operate. Adjust or service brakes as necessary.
- Stop machine if anyone enters the area.
- Do not leave machine unattended when it is running.

- Use care when approaching blind corners, shrubs, trees, or other objects that may obscure vision.
- Use only accessories and attachments approved by the manufacturer of the machine. Keep safety labels visible when installing accessories and attachments.
- Do not operate machine if you are under the influence of drugs or alcohol.
- Data indicates operators 60 years and above are involved in a large percentage of riding mower-related injuries. These operators should evaluate their ability to operate the riding mower safely enough to protect themselves and others from serious injury.
- Do not wear radio or music headphones. Safe service and operation requires your full attention.

Maintenance and Storage

- Keep all nuts, bolts and screws tight to be sure the equipment is in safe working condition.
- Never store the equipment with fuel in the tank inside a building where fumes can reach an open flame or spark.
- Allow the engine to cool before storing in any enclosure.
- To reduce the fire hazard, keep the engine, silencer, battery compartment and fuel storage area free of grass, leaves, or excessive grease.
- Check the grass catcher frequently for wear or deterioration.
- Replace worn or damaged parts for safety.
- If the fuel tank has to be drained, this should be done outdoors.
- On multi-bladed machines, take care as rotating one blade can cause other blades to rotate.
- When machine is to be parked, stored or left unattended, lower the cutting means unless a positive mechanical lock is used.
- Use jack stands or lock service latches to support components when required. Securely support any machine elements that must be raised for service work.
- Before servicing machine or attachment, carefully release pressure from any components with stored energy, such as hydraulic components or springs.
- Release hydraulic pressure by lowering attachment or cutting units to the ground or to a mechanical stop and move hydraulic control levers back and forth.
- Disconnect battery or remove spark plug (for gas engines) before making any repairs. Disconnect the negative terminal first and the positive last. Reconnect positive first and negative last.

Safety

- Use care when checking blades. Wrap the blades or wear gloves, and use caution when servicing them. Only replace blades. Never straighten or weld them.
- Keep hands, feet, clothing, jewelry and long hair away from moving parts. If possible, do not make adjustments with the engine running.
- Charge batteries in an open well ventilated area, away from spark and flames. Unplug charger before connecting or disconnecting from battery. Wear protective clothing and use insulated tools.

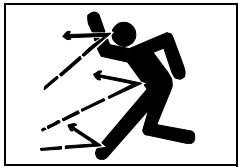

Checking Mowing Area

- Clear mowing area of objects that might be thrown. Keep people and pets out of mowing area.
- Low-hanging branches and similar obstacles can injure the operator or interfere with mowing operation. Before mowing, identify potential obstacles such as low-hanging branches, and trim or remove those obstacles.
- Study mowing area. Set up a safe mowing pattern. Do not mow where traction or stability is doubtful.
- Test drive area with mower lowered but not running. Slow down when you travel over rough ground.

Parking Safely

1. Stop machine on a level surface, not on a slope.
2. Disengage mower blades or any other attachments.
3. Lower attachments to the ground.
4. Lock the park brake.
5. Stop the engine.
6. Remove the key.
7. Wait for engine and all moving parts to stop before you leave the operator's seat.
8. Close fuel shut-off valve, if your machine is equipped.
9. Disconnect the negative battery cable or remove the spark plug wire(s) (for gasoline engines) before servicing the machine.

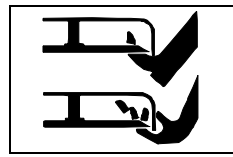

Rotating Blades are Dangerous

HELP PREVENT SERIOUS OR FATAL ACCIDENTS:

- Rotating blades can cut off arms and legs, and throw objects. Failure to observe safety instructions could result in serious injury or death.
- Keep hands, feet and clothing away from mower deck when engine is running.
- Be alert at all times, drive forward and in reverse carefully. People, especially children can move quickly into the mowing area before you know it.
- Before backing up, stop mower blades or attachments and look down and behind the machine carefully, especially for children.
- Do not mow in reverse.
- Shut off blades when you are not mowing.
- Park machine safely before leaving the operator's station for any reason including emptying the grasscatchers or unplugging the chute.
- The mower blades should stop in approximately five seconds when the mower is disengaged. If you believe that your blades may not be stopping in that period of time, take your machine to your authorized dealer where they can safely check and service your machine.

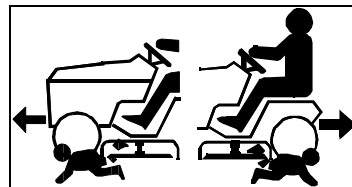

Protect Children

- Death or serious injury can occur when young children associate having fun with a lawn mowing machine simply because someone has given them a ride on a machine.
- Children are attracted to lawn mowing machines and mowing activities. They don't understand the dangers of rotating blades or the fact that the operator is unaware of their presence.
- Children who have been given rides in the past may suddenly appear in the mowing area for another ride and be run over or backed over by the machine.
- Tragic accidents with children can occur if the operator is not alert to the presence of children, especially when a child approaches a machine from behind. Before and while backing up, stop mower blades and look down and behind the machine carefully, especially for children.
- Never carry children on a machine or attachment, even with the blades off. Do not tow children in a cart or trailer.

Safety

They can fall off and be seriously injured or interfere with safe machine operation.

- Never use the machine as a recreational vehicle or to entertain children.
- Never allow children or an untrained person operate the machine. Instruct all operators not to give children a ride on the machine or in an attachment.
- Keep children indoors, out of the mowing area, and in the watchful eye of a responsible adult, other than the operator, when a mower is being operated.
- Stay alert to the presence of children. Never assume that children will remain where you last saw them. Turn the machine off if a child enters the work area.
- Use extreme care when approaching blind corners, shrubs, trees, or other objects that may block your view of a child.

Operating on Slopes

NOTE: Make a photocopy of this page and cut out angle chart (A) to use for measuring slope angle.

- Slopes are a major factor related to loss-of-control and tipover accidents, which can result in severe injury or death. Operation on all slopes requires extra caution.

Identify Slopes for Safe Operation

- Follow safe procedures for operation on slopes. Measure slopes of all moving sites to determine which slopes are safe for mowing with a ride-on mower. Always use common sense and good judgement when performing this survey.

Measuring Slopes

- Suggested Method 1: Lay a straight piece of sturdy lumber 1.2 m (4 ft) long on the slope and measure the angle of the slope with an angle indicator or protractor level.
- Suggested Method 2: Refer to the slope gauge provided with this manual.

Operate Safely on Slopes

- Exceeding the recommended maximum slope angle increases the risk of rollover accidents that can result in serious injury or death.
- Never mow or operate ride-on mower on slope angles greater than 15° with the lawn ride-on mower in its basic configuration. The basic configuration is the ride-on mower with mower deck and not other attachments. (A 15° slope is a slope that rises 1.6 m (5.25 ft) over a horizontal distance of 6.1 m (20 ft).)
- When using attachments, never mow or operate the ride-on mower on slope angles greater than 10°. The addition of

a weather enclosure, material collection system, or other attachments will increase the risk of a rollover. (A 10° slope is a slope that rises 1 m (3.5 ft) over a horizontal distance of 6.1 m (20 ft).)

- On slope angles of 10° or less, the risk of rollover is low, but as the slope angle increases to the recommended maximum, the risk increases to a medium level.
- Always consider potential turf conditions and slope angles when determining the risk of loss-of-control and tip-over accidents.
- Drive slowly when mowing or operating on slopes.
- If you feel uneasy on a hillside, do not mow or operate on it.
- Mow up and down slopes, not across.
- Watch for holes, ruts, bumps, rocks, or other hidden objects. Uneven terrain could overturn the ride-on mower. Tall grass can hide obstacles.
- Drive slowly so you will not have to stop while on a slope.
- Do not mow on wet grass. Tires may lose traction. Tires may slip on slopes even though the brakes are functioning properly.
- Avoid starting, stopping or turning on a slope. If the tires lose traction, disengage the PTO and proceed slowly, straight down the slope.
- Keep all movement on slopes slow and gradual. Do not make sudden changes in speed or direction, which could cause the ride-on mower to roll over.

Safety

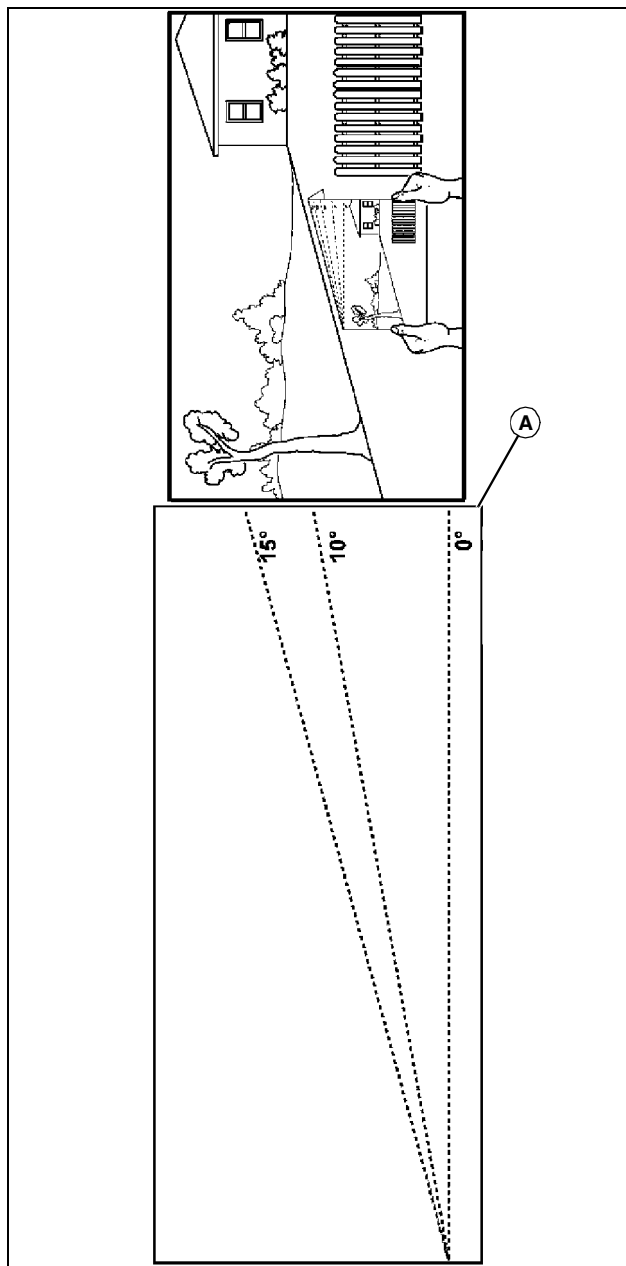

MX51796

Operating Near Hazards

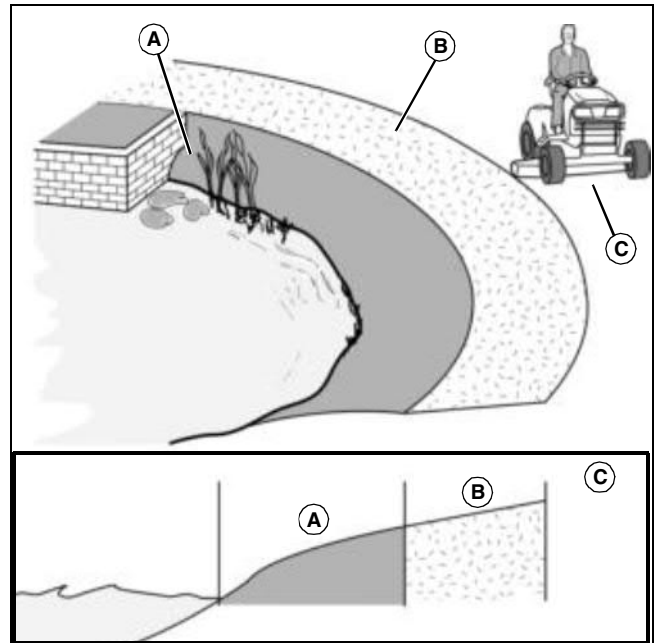

MX51888

Picture Note: Example side view of slope and hazards, showing areas (A), (B), and (C).

- Do not mow or operate machine in areas adjacent to hazards that may cause the machine to roll over. The machine could suddenly lose traction, slide, and/or roll over if a wheel goes over the edge or if the edge breaks away.
- Hazards (A) include but are not limited to:
 - Drop-offs, ditches, embankments, or bodies of water.
 - Areas of unsafe slope, soft ground, edges along bodies of water, or area with holes, ruts, bumps, or other hidden objects.
- Maintain a buffer area (B) at least as wide as the machine between hazards (A) and the mowing area (C). Do not mow or operate the machine in the hazard area or buffer area.
- Only mow or operate the machine in the mowing area (C). Do not exceed the recommended slope operating angle. Refer to the "Operate Safely on Slopes" section.
- Use a walk-behind mower or string trimmer in and around areas (A) and (B).



Keep Riders Off

- Only allow the operator on the machine. Keep riders off.
- Riders on the machine or attachment may be struck by foreign objects or thrown off the machine causing serious injury.

Safety

- Riders obstruct the operator's view resulting in the machine being operated in an unsafe manner.



Stay Clear of Rotating Drivelines

Entanglement in rotating driveline can cause serious injury or death.

- Wear close fitting clothing.
- Stop the engine and be sure PTO driveline is stopped before getting near it.

Checking Wheel Hardware

- A serious accident could occur causing serious injury if wheel hardware is not tight.
- Check wheel hardware tightness often during the first 100 hours of operation.
- Wheel hardware must be tightened to specified torque using the proper procedure anytime it is loosened.

Towing Loads Safely

- Stopping distance increases with speed and weight of towed load. Travel slowly and allow extra time and distance to stop.
- Total towed weight must not exceed combined weight of pulling machine, ballast and operator. Use counterweights or wheel weights as described in the attachment or pulling machine operator's manual.
- Excessive towed load can cause loss of traction and loss of control on slopes. Reduce towed weight when operating on slopes.
- Never allow children or others in or on towed equipment.
- Use only approved hitches. Tow only with a machine that has a hitch designed for towing. Do not attach towed equipment except at the approved hitch point.
- Follow the manufacturer's recommendations for weight limits for towed equipment and towing on slopes.
- Towed attachments will increase the risk of rollover. Refer to the "Operating on Slopes" section for more information.
- Do not turn sharply. Use additional caution when turning or operating under adverse surface conditions. Use care when reversing.
- Do not shift to neutral and coast downhill.

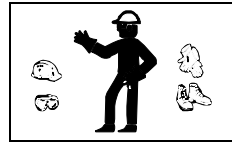

Wear Appropriate Clothing

- Always wear eye protection when operating the machine.
- Wear close fitting clothing and safety equipment appropriate for the job.
- While operating this machine, always wear substantial footwear and long trousers. Do not operate the equipment when barefoot or wearing open sandals.
- Wear a suitable protective device such as earplugs. Loud noise can cause impairment or loss of hearing.



Practice Safe Maintenance

- Only qualified, trained adults should service this machine. Understand service procedure before doing work.
- Never operate machine in a closed area where dangerous carbon monoxide fumes can collect.
- Keep all nuts and bolts tight, especially blade attachment bolts, to be sure the equipment is in safe working condition.
- Never tamper with safety devices. Check their proper operation regularly.
- Keep machine free of grass, leaves or other debris build-up. Clean up oil or fuel spillage and remove any fuel-soaked debris. Allow the machine to cool before storing.
- If you strike a foreign object, stop and inspect the machine. Repair, if necessary, before restarting.
- Never make any adjustments or repairs with the engine running. Wait for all movement to stop on machine before adjusting, cleaning or repairing.
- Check grasscatcher components and the discharge guard frequently and replace with manufacturer's recommended parts, when necessary. Grasscatcher components are subject to wear, damage, and deterioration which could expose moving parts or allow objects to be thrown.
- Mower blades are sharp. Wrap the blade or wear gloves, and use extra care when servicing them. Only replace blades. Never straighten or weld them.
- Check brake operation frequently. Adjust and service as required.
- Maintain or replace safety and instruction labels, as necessary.
- On multi-bladed machines, take care as rotating one blade can cause other blades to rotate.
- Keep hands, feet, clothing, jewelry, and long hair away from any moving parts, to prevent them from getting caught.

Safety

- Lower any attachments to the ground before cleaning or servicing machine. Disengage all power and stop the engine. Lock park brake and remove the key. Let machine cool.
- Securely support any machine elements that must be raised for service work. Use jack stands or lock service latches to support components when needed.
- Disconnect battery or remove spark plug wire (for gasoline engines) before making any repairs. Disconnect negative terminal first and positive last. Install positive terminal first and negative last.
- Before servicing machine or attachment, carefully release pressure from any components with stored energy, such as hydraulic components or springs.
- Keep all parts in good condition and properly installed. Fix damage immediately. Replace worn or broken parts.
- Charge batteries in an open, well-ventilated area, away from sparks. Unplug battery charger before connecting or disconnecting from the battery. Wear protective clothing and use insulated tools.
- Do not strike the flywheel with a hammer or hard object because the flywheel may later shatter during operation.
- If equipped with hydraulic lift - release hydraulic pressure by lowering attachment or cutting units to the ground or to a mechanical stop and move hydraulic control levers back and forth.



Avoid High Pressure Fluids

- Hydraulic hoses and lines can fail due to physical damage, kinks, age, and exposure. Check hoses and lines regularly. Replace damaged hoses and lines.
- Hydraulic fluid connections can loosen due to physical damage and vibration. Check connections regularly. Tighten loose connections.
- Escaping fluid under pressure can penetrate the skin causing serious injury. Avoid the hazard by relieving pressure before disconnecting hydraulic or other lines. Tighten all connections before applying pressure.
- Search for leaks with a piece of cardboard. Protect hands and body from high pressure fluids.
- If an accident occurs, see a doctor immediately. Any fluid injected into the skin must be surgically removed within a few hours or gangrene may result. Doctors unfamiliar with this type of injury should reference a knowledgeable medical source. Such information is available from Deere & Company Medical Department in Moline, Illinois, U.S.A. Information may be obtained in the United States and

Canada only by calling 1-800-822-8262.



Prevent Fires

- Besides routine maintenance, one of the best ways to keep your John Deere equipment running efficiently and to reduce fire risk is to regularly remove debris buildup from the machine.
- Please review these recommendations with all operators. See your John Deere dealer with questions.
- Always follow all safety procedures posted on the machine and in this operator manual. Before carrying out any inspection or cleaning, always shut off engine, set parking brake and remove ignition key.
- After operating, allow machine to cool in an open area before cleaning or storing. Do not park machine near flammable materials such as wood, cloth or chemicals.
- Empty any grasscatcher bags or containers completely before storing.
- Frequency of these inspections and cleaning will vary depending on a number of factors including operating conditions, machine configuration, operating speeds and weather conditions particularly dry, hot and windy conditions. When you are operating in these conditions, inspect and clean these areas frequently throughout the day.
- Wind direction, terrain type and moisture content of surrounding vegetation can effect where and how much debris accumulates.
- Debris can accumulate anywhere on the machine, especially on horizontal surfaces.
- Keeping engine area clean will provide the greatest impact on fire prevention. Other areas requiring regular inspection and cleaning include behind wheel rims, wire harness, hose/line routings, mowing attachments, etc. Compressed air, leaf blowers or high pressured water can assist keeping these areas clean.
- Excess lubrication or fuel/oil leaks or spills on the machine can also serve as collection sites for debris. Prompt machine repair and oil/fuel cleanup will minimize the potential for debris collection and reduced cooling throughout machine life.
- Bearing failures or overheating can result in a fire. To reduce this risk, always follow the instructions in the machine operator's manual regarding lubrication intervals and locations. Washing the machine while warm may also reduce bearing life and increase potential for premature bearing failure.

Safety

- Always shut off fuel when storing or transporting machine, if the machine has a fuel shutoff.



Tire Safety

Explosive separation of a tire and rim parts can cause serious injury or death:

- Do not attempt to mount a tire without the proper equipment and experience to perform the job.
- Always maintain the correct tire pressure. Do not inflate the tires above the recommended pressure. Never weld or heat a wheel and tire assembly. The heat can cause an increase in air pressure resulting in a tire explosion. Welding can structurally weaken or deform the wheel.
- When inflating tires, use a clip-on chuck and extension hose long enough to allow you to stand to one side and NOT in front of or over the tire assembly.
- Check tires for low pressure, cuts, bubbles, damaged rims or missing lug bolts and nuts.

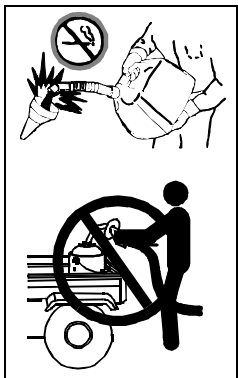

Handling Fuel Safely

To avoid personal injury or property damage, use extreme care in handling fuel. Fuel is extremely flammable and fuel vapors are explosive:

- Extinguish all cigarettes, cigars, pipes, and other sources of ignition.
- Use only approved non-metal, portable fuel containers. If using a funnel, make sure it is plastic and has

no screen or filter.

- Never remove the fuel tank cap or add fuel with the engine running. Allow engine to cool before refueling.
- Never add fuel to or drain fuel from the machine indoors. Move machine outdoors and provide adequate ventilation.
- Clean up spilled fuel immediately. If fuel is spilled on clothing, change clothing immediately. If fuel is spilled near machine, do not attempt to start the engine but move the machine away from the area of spillage. Avoid creating any source of ignition until fuel vapors have dissipated.
- Never store the machine or fuel container where there is an open flame, spark, or pilot light such as on a water heater or other appliance.
- Prevent fire and explosion caused by static electric discharge. Static electric discharge can ignite fuel vapors in an ungrounded fuel container.

- Never fill containers inside a vehicle or on a truck or trailer bed with a plastic liner. Always place containers on the ground away from your vehicle before fueling.
- Remove fuel-powered equipment from the truck or trailer and refuel it on the ground. If this is not possible, then refuel such equipment with a portable container, rather than from a fuel dispenser nozzle.
- Keep the nozzle in contact with the rim of the fuel tank or container opening at all times until the fueling is complete. Do not use a nozzle lock-open device.
- Never overfill fuel tank. Replace fuel tank cap and tighten securely.
- Replace all fuel container caps securely after use.
- For gasoline engines, do not use gas with methanol. Methanol is harmful to your health and to the environment.

Handling Waste Product and Chemicals

Waste products, such as, used oil, fuel, coolant, brake fluid, and batteries, can harm the environment and people:

- Do not use beverage containers for waste fluids - someone may drink from them.
- See your local Recycling Center or authorized dealer to learn how to recycle or get rid of waste products.
- See your local Recycling Center or authorized dealer to learn how to put your machine out of service at the end of the machine's service life.

Machine Cleanout

Prevent Fires

- Besides routine maintenance, one of the best ways to keep your John Deere equipment running efficiently and to reduce fire risk is to regularly remove debris buildup from the machine.
- Please review these recommendations with all operators. See your John Deere dealer with questions.
- Always follow all safety procedures posted on the machine and in this operator manual. Before carrying out any inspection or cleaning, always shut off engine, set parking brake and remove ignition key.
- After operating, allow machine to cool in an open area before cleaning or storing. Do not park machine near flammable materials such as wood, cloth or chemicals.
- Empty any grasscatcher bags or containers completely before storing.
- Frequency of these inspections and cleaning will vary depending on a number of factors including operating conditions, machine configuration, operating speeds and weather conditions particularly dry, hot and windy conditions. When you are operating in these conditions, inspect and clean these areas frequently throughout the day.
- Wind direction, terrain type and moisture content of surrounding vegetation can effect where and how much debris accumulates.
- Debris can accumulate anywhere on the machine, especially on horizontal surfaces.
- Keeping engine area clean will provide the greatest impact on fire prevention. Other areas requiring regular inspection and cleaning include behind wheel rims, wire harness, hose/line routings, mowing attachments, etc. Compressed air, leaf blowers or high pressured water can assist keeping these areas clean.
- Primary areas that must be inspected and cleaned on the machine include (See Safety Label Section):

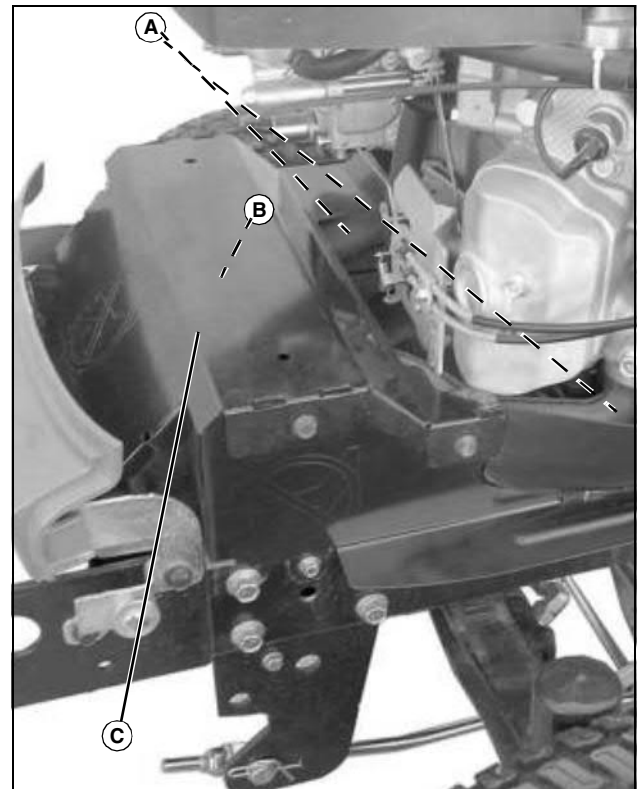

MX49124

a. Exhaust manifold (A), muffler pipe (B), muffler and muffler shield (C).



Suggest:

If the above button click is invalid.

Please download this document

first, and then click the above link

to download the complete manual.

Thank you so much for reading

Machine Cleanout

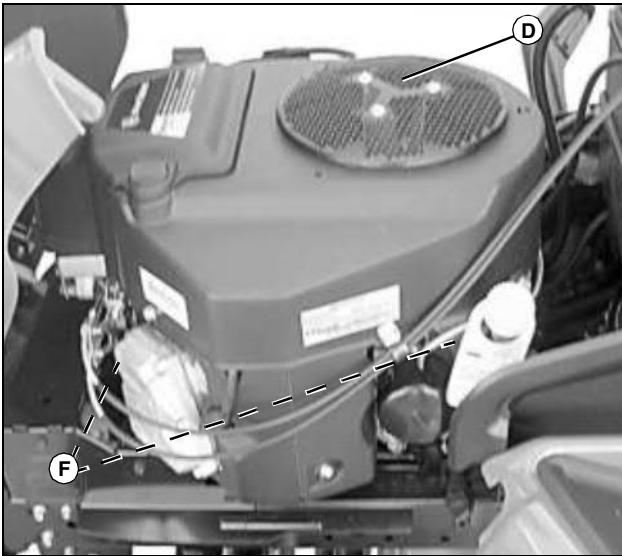

MX49125

Picture Note: Air-Cooled Engine Shown.

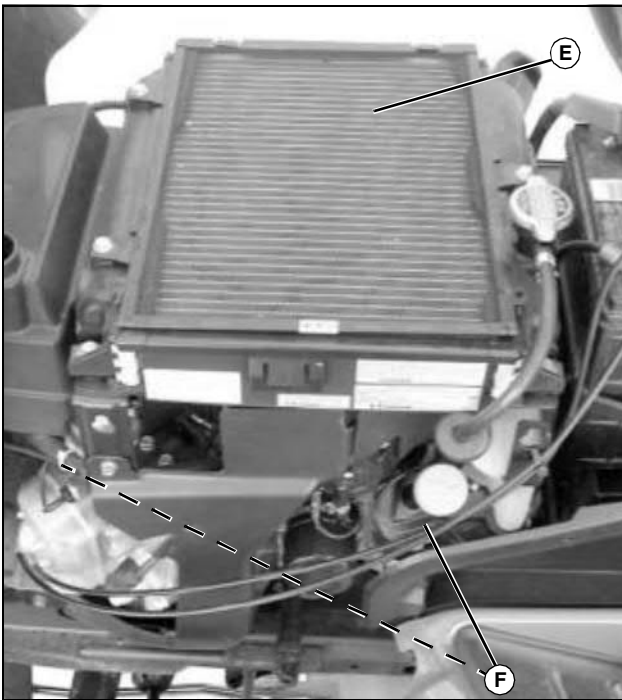

MX49126

Picture Note: Liquid-Cooled Engine Shown.

b. Engine intake screen (D) or radiator (E), and cooling fins (F).

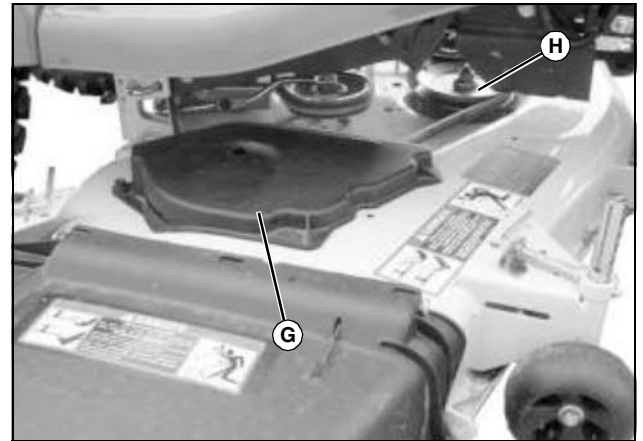

MX49127

c. Top of mower deck, under shields (G), including spindle (H) and belt areas.

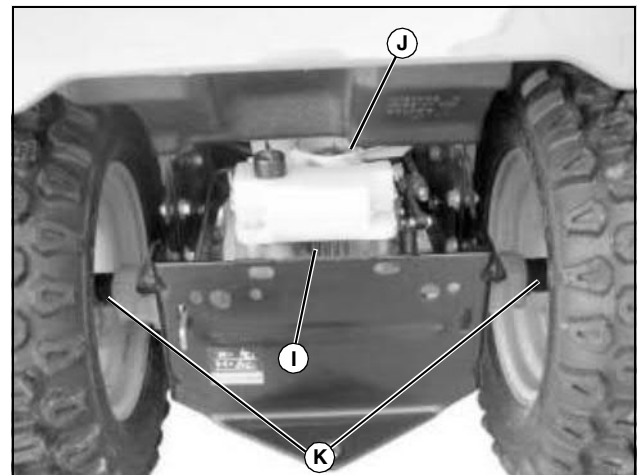

MX49128

d. On or near transmission (I), transmission fan (J), and driveline (K).

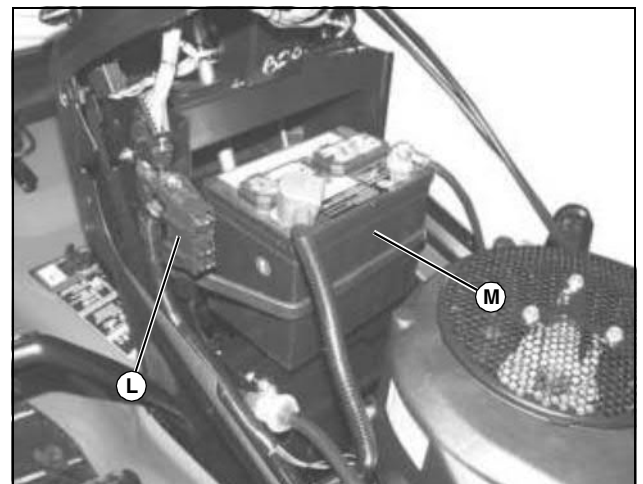

MX36201

e. On right side near fuse block (L), and all wiring, including the battery (M) and related wiring harnesses.

<https://www.ebooklibonline.com>

Hello dear friend!

Thank you very much for reading.

Enter the link into your browser.

The full manual is available for immediate download.

<https://www.ebooklibonline.com>