

# No. 101 Quik-Tatch One-Row Corn Picker



JOHN DEERE

## OPERATORS MANUAL No. 101 Quik-Tatch One-Row Corn Picker

OMN11260 L0 English

OMN11260 L0

LITHO IN U.S.A.  
ENGLISH



# INTRODUCTION

Back of your John Deere No. 101 Quik-Tatch Corn Picker is an organization that has been building farm equipment for more than one hundred years. In the plant where your corn picker was built, fine materials, high-grade workmanship, complete testing, and thorough inspection are combined to give you dependable performance and economical operation.

The way you operate your corn picker and the care you give it have much to do with the service and satisfaction you will get from it. This manual has been carefully prepared and illustrated to show you what to do, when to do it, and how to do it. Make it your guide. Study it carefully. Refer to it often. Keep it handy at all times for quick reference. Only by following the instructions it contains can you hope to get the most from your investment.

If you find you need information not covered in this manual, see your John Deere dealer. He has the latest information on how to get the best service from your machine and can give you prompt "know-how" service in the field or in his shop.

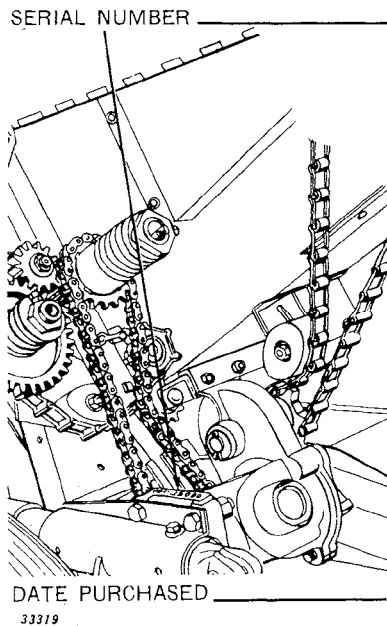

When in need of parts, go to your John Deere dealer. Be sure to give him the correct part number and a complete description of the part. This information can be obtained by referring to the exploded view section of this manual, where these parts can be readily and accurately identified. Also be sure to give him the serial number and the year purchased. This information should be recorded in the space provided on this page as soon as you have received your picker.

**LOCATION REFERENCES:** "Right" and "Left," "Front" and "Rear," refer to the operator's "Right" or "Left," and "Front" or "Rear," when facing the same direction machine is headed or traveling.

## TABLE OF CONTENTS

	<i>Page</i>
SPECIFICATIONS AND DATA.....	3
LUBRICATION.....	4-8
OPERATION.....	9-12
Breaking in the New Picker—Starting in the Field.....	9
Operating Precautions.....	12
OPERATING ADJUSTMENTS.....	12-31
Tilting.....	12-14
Gatherers.....	15-16
Snapping Rolls.....	17-19
First-Elevator—Trash Rolls.....	20
Husking Rolls.....	21
Fan—Fan Sheave—Husk Auger.....	22-23
Wagon Elevator—Shipping and Storage Wheel.....	24-25
Raising Jack.....	26-27
Slip Clutches.....	28
Chains—Drive Chains.....	29-31
Care of Rubber Tires.....	32
When the Season Is Over.....	34
PICKING DIFFICULTIES.....	35-41
EXTRA EQUIPMENT.....	43-47
Gatherer Fender Sticks—Spiral Strips for Snapping Rolls.....	42
Trash Knives for Snapping Rolls.....	43
Husking Rolls Cover.....	44
Trash Knife for Husking Roll Drag Auger.....	45-46
Wagon Box Steel Flareboards—Weight Box.....	47
SHIPPING BUNDLES.....	48-50
ASSEMBLY INSTRUCTIONS.....	51-90
Section I—General Assembly Instructions.....	51-53
Section II—Connecting Picker to John Deere Models “50,” “60,” “70,” “A,” “B,” and “G” Tractor Equipped with Powr-Trol.....	55-60
Section III—Connecting Picker to John Deere Models “50,” “60,” “70,” “A,” “B,” and “G” Tractors without Powr-Trol (Hand Tilt).....	61-63
Section IV—Connecting Picker to John Deere Model “40” Tractor.....	64-68
Section V—Connecting Picker to John Deere Model “40” Stand- ard Tractor.....	69-74
Section VI—Connecting Picker to John Deere Model “MT” Tractor.....	75-77
Section VII—Connecting Picker to John Deere Model “M” Trac- tor.....	78-83
Section VIII—Connecting Picker to I.H.C. Farmall Models H, Super H, M, Super M, and MD Tractors.....	84-85
Section IX—Connecting Picker to I.H.C. Farmall Models C and Super C Tractors.....	86-87
Section X—Connecting Picker to Ford, Ferguson, and Ford- Ferguson Tractors.....	88-89
Section XI—Connecting Picker to Allis-Chalmers Model WD Tractor.....	90

**<https://www.ebooklibonline.com>**

Hello dear friend!

Thank you very much for reading.

Enter the link into your browser.

The full manual is available for immediate download.

**<https://www.ebooklibonline.com>**

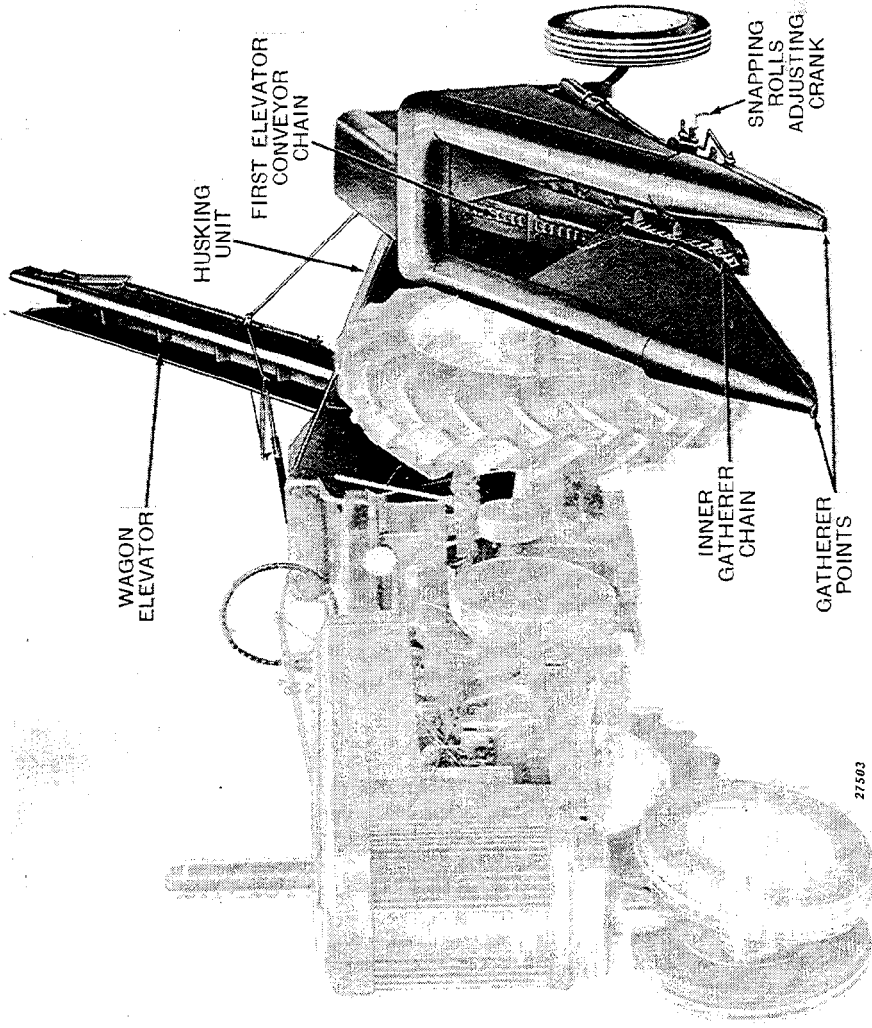

Complete View of John Deere No. 101 Quik-Tatch Corn Picker  
with Model "60" Tractor

27503

## SPECIFICATIONS AND DATA

No. of Rows.....	1
Right- or Left-Hand Machine.....	Left
Distance Center Line of Tractor to Corn Row.....	60" to 65"
Gatherer Points Hinged or Rigid.....	Hinged
Points Hinged Above or Below Gatherer Chain.....	Above
No. of Gatherer Chains per Snapping Unit.....	2
Type of Gatherer Chains.....	Steel Link
Min. Clearance between Gatherer Chains and Ground (Inches).....	0 - Up
Gatherer Chains Adjustable Laterally.....	No
Dist. Gath. Chains Ahead of Snapping Roll Entry.....	12"
Length Snapping Rolls.....	41"
Width Snapped Corn Elevator.....	6-1/2"
No. of Husking Rolls.....	2
Diameter of Husking Rolls.....	3"
Length of Husking Rolls.....	36"
Type of Husking Rolls.....	Rubber Roll Spiral Ribbed Mating Roll Smooth Wood with Steel Inserts
Shelled Corn Saver.....	Yes
Cleaning Fan.....	Yes
Depth Ear Corn Elevator, Inches.....	7-1/2"
Width Ear Corn Elevator, Inches.....	6-1/2" - 10-1/2"
Offset of Hitch Point From Inside Row.....	69"
Dist. Inside Row to Wagon Center Line (with Wagon Hitch).....	5' 0"
Width Over-All for Transport.....	10' 4"
Over-All Width of Picker Only.....	8' 6"
Height with Wagon Elevator.....	9'
Length with Wagon Elevator.....	17' 9"
Tire Size.....	5:00 x 16, 4:00 x 9 (Caster Wheel)
Approx. Shipping Weight—with Take-Off Connection.....	1590 Lbs.

Tractor Tire Inflation: The small amount of weight added to the tractor by the No. 101 Quirk-Tatch Corn Picker does not require a special tire inflation table, so the regular tire inflation table included in the Tractor Operator's Manual will apply.

## LUBRICATION

The economical and efficient operation of any machine depends on regular and proper lubrication of all moving parts with a quality lubricant. Greasing is just as vital to the service life of farm machinery as is the use of proper lubricating oil in the crankcase of an automobile or tractor. Neglect leads to reduced efficiency, heavy draft, wear, breakdown and costly replacement of parts.

### LUBRICATION CHARTS

All lubrication points are illustrated on succeeding pages. Bearings which are not equipped with grease fittings are sealed bearings and do not require lubrication for the life of the machine.

Grease each fitting periodically as specified in chart using the proper lubricant. Wipe dirt off all fittings before greasing. Do not overlubricate. Excessive grease will gather dust and dirt. Replace all missing grease fittings immediately.

Use a good grade of heavy machine oil in oil can. When lubricating picker make a practice of putting a few drops of oil on all linkages, clevises, and other moving parts. This will make them work easier and prolong their life.

**CAUTION:** Fill the two main drive gear cases approximately  $\frac{3}{4}$  full with No. 1 fibre pressure-gun grease.

**Fill other gear cases until grease comes out small vent hole.**

**IMPORTANT:** When machine is new, lubricate the bearings often during the first few days.

---

**THESE SYMBOLS DESIGNATE TYPE OF LUBRICANT**



**BLACK GREASE GUN**—use only pressure-gun grease.

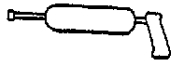

**WHITE GREASE GUN**—use only No. 1 fibre pressure-gun grease.



**OIL CAN**—use only heavy machine oil.



**HAND-PACK**—use only pressure-gun grease.

6970

**GATHERERS AND SNAPPING ROLLS**

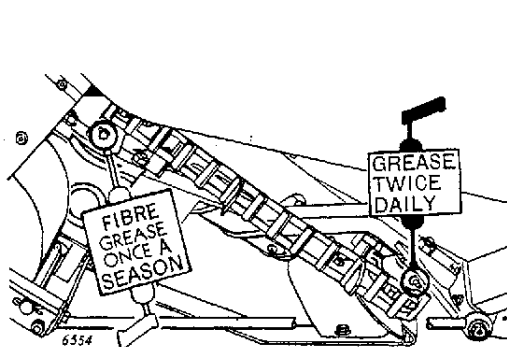

*Right-Hand Gatherer*

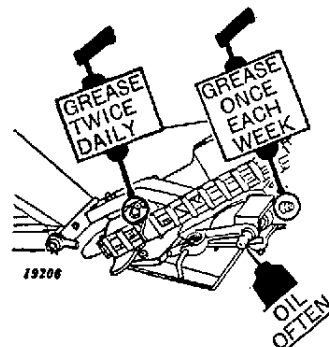

*Left-Hand Gatherer*

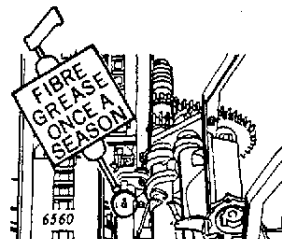

*Upper Right-Hand Gatherer*

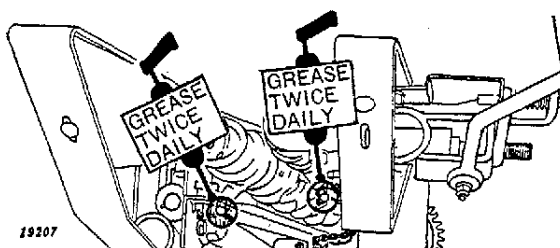

*Lower End of Snapping Rolls*

### GATHERERS AND SNAPPING ROLLS

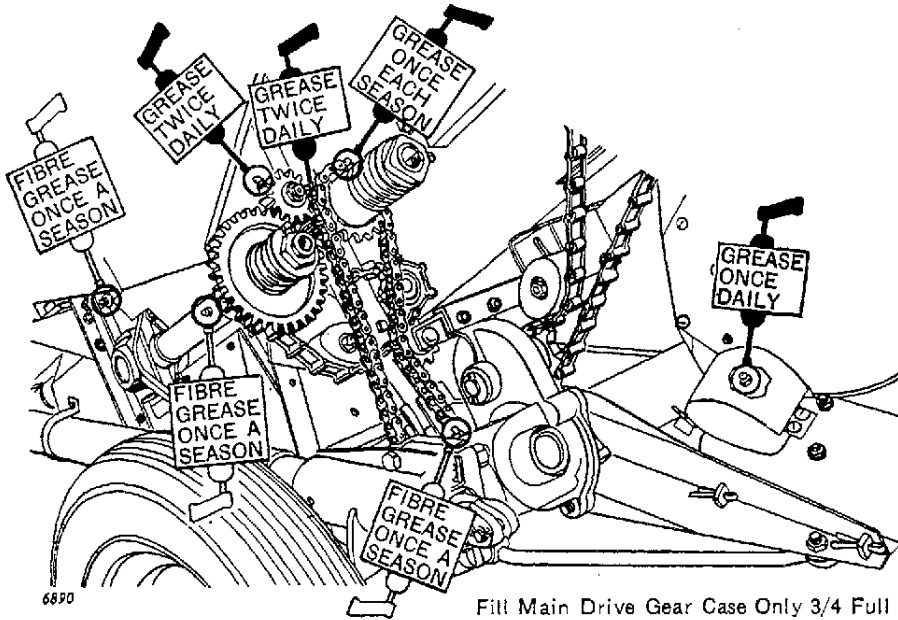

Fill Main Drive Gear Case Only 3/4 Full

### FIRST ELEVATOR AND TRASH ROLLS

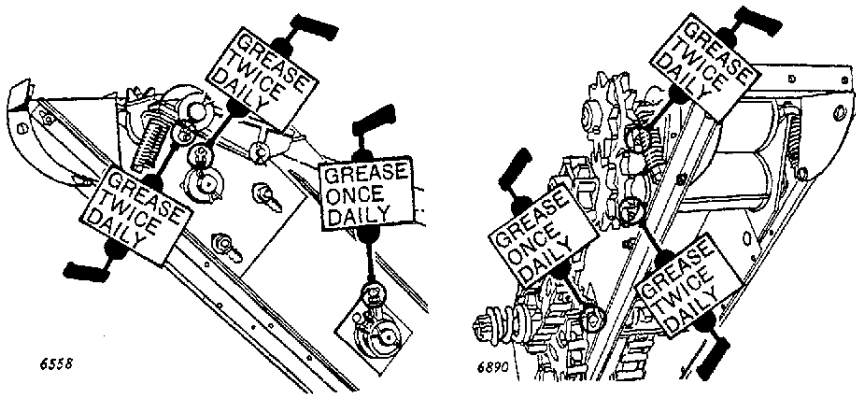

### HUSKING UNIT

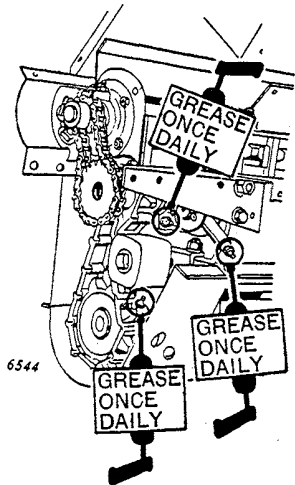
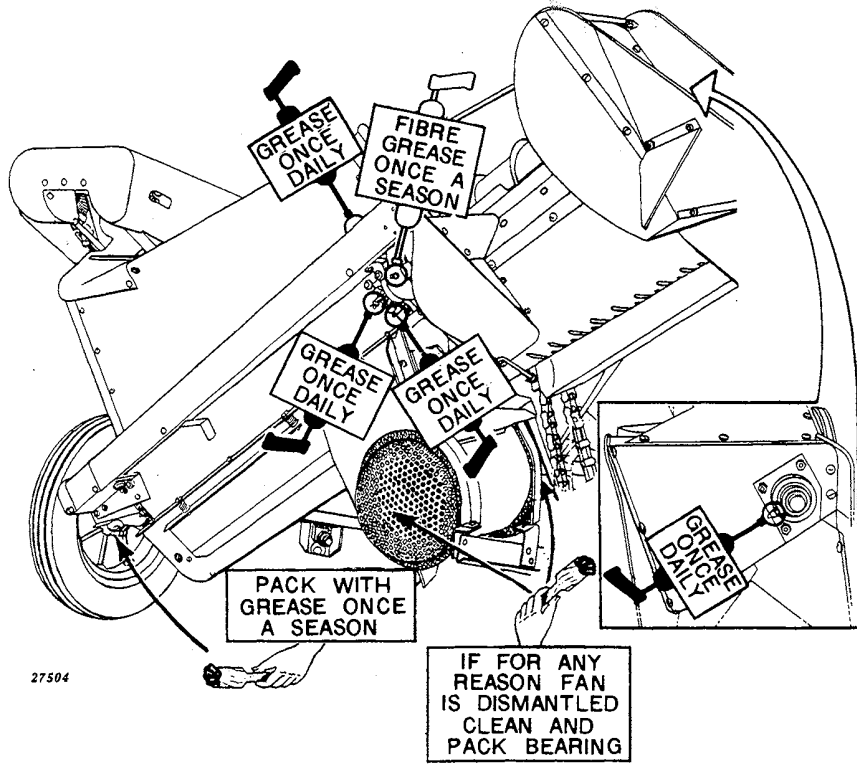

Lower End of Husking Unit

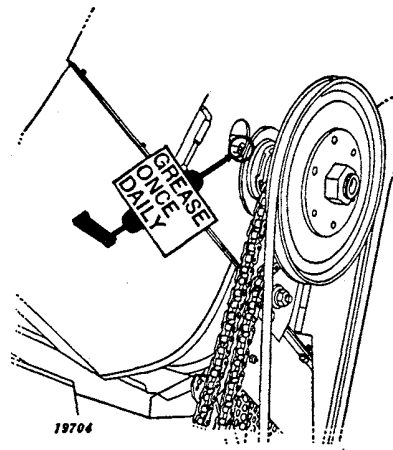

Upper End of Husking Unit

### WAGON ELEVATOR

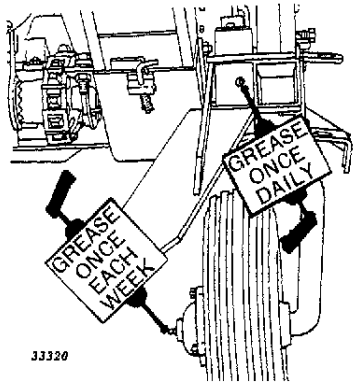

33320

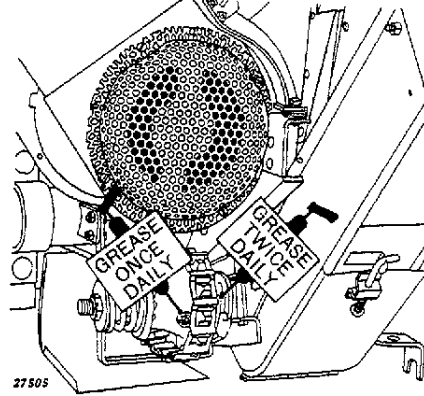

27505

### MAIN DRIVE GEAR CASE

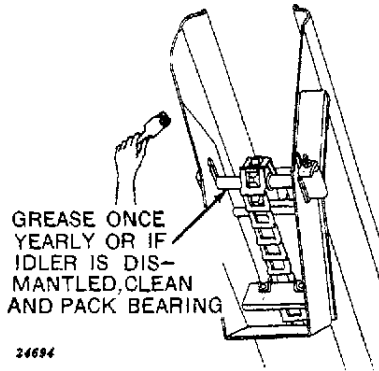

24684

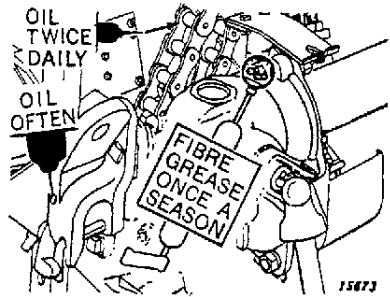

15873

Fill Gear Case Only 3/4 Full

### LUBRICATE OFTEN FOR EASY PICKING

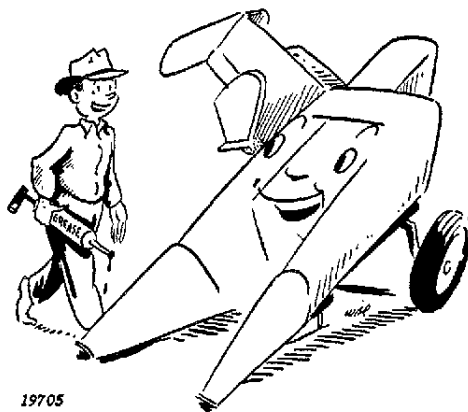

19705

## **OPERATION**

### **BREAKING IN THE NEW PICKER**

1. After the assembly and connecting to tractor has been completed, the entire machine should be gone over and bolts tightened. A loose bolt may cause undue wear and result in replacement of parts.

2. Inspect all chains for proper tension. (See Pages 30 and 31.) Tighten chains only enough to prevent links from climbing sprocket teeth.

3. V-Belt drive for fan (see Page 22) should be checked and be just tight enough to eliminate slippage.

4. Slip each slip clutch to loosen paint from faces. Slip clutch should be set tight enough for ordinary work without slipping but loose enough to slip easily should clogging occur (see Page 28).

5. Lubricate all bearings generously as specified in Lubrication Charts on Pages 5 to 8, inclusive.

6. The new machine should be given an empty running "breaking in" period of at least one hour to allow the parts to work in gradually. It should be started at a slow idling speed for the first thirty minutes and increased to full speed for the rest of the period. After a short run at slow idling speed, stop machine and inspect completely, making a check for loose bolts, heating bearings, binding parts, chain tensions, etc. Inspect picker frequently during the "break-in" period.

**Remember, the breaking-in period is just as important with a new picker as it is with a new automobile.**

### **STARTING IN THE FIELD**

#### **Understand the Function of All Working Units.**

A corn picker must be built to handle a wide range of conditions. Field conditions vary from year to year, from day to day, and even from hour to hour. Different varieties of corn present widely different picking problems. A careful study of the adjustments on your picker and, what they accomplish under different conditions, will allow you to reap the many benefits and economies that a picker can provide.

Remember that compromises are often necessary if you are to obtain the best over-all results. To illustrate, if clean husking is insisted upon a little more corn may be shelled. If shelling is to be held to a minimum, a few more ears with husks must be accepted. Always remember, the most important objective is to get the corn out of the field and into the wagon.

Before starting your picker in the field, be sure you are thoroughly familiar with the function of each working unit. Study the illustrations showing these units carefully and become familiar with the adjustments necessary to obtain best results.

### Pick Early.

One of the main advantages of owning a corn picker is its capacity for work, enabling one to finish picking while conditions are most favorable. While the John Deere No. 101 Quik-Tatch Corn Picker will handle the job under any conditions as well or better than other pickers, we recommend picking early and avoiding the troubles and disagreeable features that accompany conditions of frozen ground, extremely cold weather and dried-out, frozen, and rotten stalks.

### Inspect Machine Before Starting.

Improper setting-up may cause inferior work and damage to the machine. Inspect the entire machine before starting in the field, being sure all braces, shields, chains and different units are properly attached and adjustments made as illustrated and directed. Be sure all nuts, pins, keys, etc., are tight and that cotters are in place. Lubricate machine thoroughly according to Lubrication Charts on Pages 5 to 8, inclusive. Operate machine slowly for some time, making sure all parts are moving freely. If there is no binding or heating, then run at full speed for a few minutes. Next, go over the entire machine again to make sure all bolts are tight and that lubricant is reaching all bearings. Be sure to check tension of all chains.

### Safety Precautions.

The tractor fenders need not be removed when attaching the No. 101 Quik-Tatch Corn Picker to the tractor. If your tractor is equipped with fenders, be sure to leave them in place, as they are an additional safety feature.

This machine has been carefully shielded for your protection—nevertheless, ordinary caution must be exercised in operation. Always be sure all safety shields are in place. Avoid serious accidents by keeping hands and clothing away from chains and other moving parts. Never attempt to clean, lubricate, or adjust machine without first disengaging power take-off and shutting off tractor engine.

Do not use a cornstalk or stick to clean snapping or husking rolls of an ear or trash while power take-off is engaged. If for any reason machine should become clogged, stop tractor engine and then remove obstacle from machine. **Keep hands and feet away from snapping and husking rolls when machine is in motion.**

### The Operator.

The degree of satisfaction given by this or any other corn picker is directly dependent upon the carefulness of the picker operator. Once the picker has been adjusted to meet the crop condition, the rest is up to the operator.



The first round is usually the hardest. The tractor should be operated in low gear for a round or two until the operator becomes accustomed to the machine. Succeeding rounds can be made with the tractor in a gear the crop and conditions permit.

Excessive travel speed is one of the greatest causes of trouble. Traveling at a high rate of speed over rough ground and in heavy conditions can cause extra wear and breakage that would not occur if the picker was operated at a more reasonable speed. In average conditions the picker will do the best work when traveling from 2-1/3 to 3 miles per hour. Too high a ground speed will only tend to feed the corn faster than it can be handled and will clog the machine or leave more ears in the field. Avoid excessive travel speeds—steady work accomplishes more than fast work for a time.

Power take-off shaft of tractor should operate at about 536 rpm. Tractor engine should always be kept at a normal speed. Where difficult conditions make it necessary to slow down travel speed of tractor, the operator should shift the transmission to a lower gear, rather than throttle the engine to slow speed.



The operator should take pride in doing the best work possible under all conditions. The John Deere No. 101 Quik-Tatch Corn Picker is so designed that the operator is in a favorable position to view the crop, condition of the field, and the work of every unit. He should listen for the slipping clutches and watch

for deep furrows, rocks, or any other obstruction the gatherer points may contact. Drive the tractor carefully so the gatherer points will follow the row. When the machine is off the row even slightly, the gatherer points may strike and jar the stalk enough to snap off the ears and send them to the ground. Gatherer points should straddle the row.

Travel in the same direction that the field was last cultivated. When opening the field, it is customary to pick across the ends or around the field several times to provide sufficient space for turning. After opening the field, you can turn and pick up the unpicked down rows. Drive slowly.

**Make wide turns as picker turns faster than the wagon.** Throw wagon elevator clutch out of engagement when turning. When crossing end of field, raise gatherer points by tilting machine.

Do not overload wagon, thereby using extra power and overloading the tractor. Keep wagon wheels well greased. Be sure to drain water from tractor engine at night during freezing weather. Do not throw power take-off of tractor in or out of engagement while outfit is in motion.

## OPERATING PRECAUTIONS

Break in your new machine carefully. (See Page 9.)

Lubricate machine thoroughly and regularly. (See Lubrication Charts, Pages 5 to 8 inclusive.)

Understand the function of all working units and be familiar with all operating adjustments.

Pick early while conditions are most favorable.

Do not attempt to clean, lubricate, or adjust machine without first disengaging power take-off and shutting off tractor engine.

Don't overload—vary your travel speed according to the volume of your crop.

Drive the tractor carefully so that gatherer points will follow the row. Watch for stones or other obstructions the gatherer points may contact.

Set slip clutches just tight enough to operate under load but still loose enough to allow slipping in case of an overload. (See Page 28.)

Keep your machine in good mechanical condition.

When season is over, store your machine carefully in a dry place.

## TILTING

The picker should be tilted according to the crop and field conditions. **In ordinary conditions**, when the corn is largely standing, machine should be tilted so that the **gatherer chain lugs** operating below the gatherer hinge point, are **slightly raised above the ground** to prevent striking butts of stalks or digging into hills. With the gatherer chains raised to this position the **tips of the gatherer points should be just touching the ground**. (See Figure 5.) Since the gatherer points are hinged they will follow the contour of the ground picking up any down stalks in their path.

**In some cases of down corn** it will be necessary to tilt machine so gatherer chains are operating very close to the ground. Caution must be used when running gatherer chain lugs so close to the ground since excessive wear on gatherer slip clutches and broken gatherer chains may result from lugs striking ground as well as excessive stalks going through machine into the wagon.

Whenever conditions permit, it is a good practice to tilt machine so the tips of gatherer points are just touching the ground, maintaining a straight diagonal line, "A," Figure 5, from gatherer sheet to tip of point and gatherer chain lugs are far enough above ground so they will not strike butts of stalks or dig into hills. The way the corn hills are ridged in cultivating will determine how close you can come to this position. Keep this in mind when cultivating your field next season.

Always raise gatherer points when crossing end of field by tilting machine.

#### Range of Tilt.

**John Deere Models "50," "60," "70," "A," "B," and "G" Tractors with Powr-Trol and other tractors with comparable hydraulic control systems.**

The range of tilt is regulated by the hydraulic control lever on the tractor and the series of holes "A," Figure 2, in the lift linkage.

#### To Adjust.

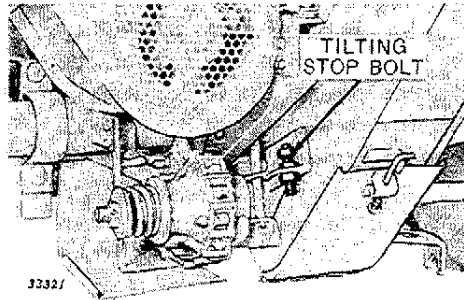

Figure 1

1. (Figure 1) Tighten tilting stop bolt so damage will not occur to picker while adjusting range of tilt.

2. (Figure 2) Using hydraulic control lever, raise gatherer points so that gatherer hinge point (long bolt which secures gatherer point hinge to hinge bracket) is 13 to 14 inches above ground. Be careful not to raise gatherer points higher than 13 to 14 inches, as damage may occur to rear of picker. If hydraulic control lever was not fully engaged to raise gatherer points to 13 or 14 inches or the desired height was not obtained, move the lift linkage on the lift arm to a different hole "A," Figure 2.

3. (Figure 1) With gatherer points raised, screw tilting stop bolt against fan support angle.

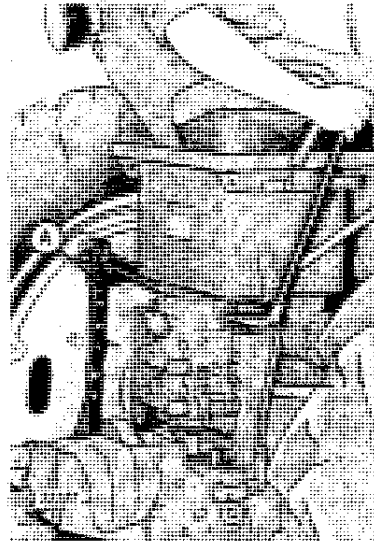

Figure 2

**John Deere Models "50," "60," "70," "A," "B," and "C" Tractors without Powr-Trol (Hand Tilt).**

The range of tilt is regulated by the hand tilt lever and the series of holes in the lift linkage.

**To Adjust.**

1. (Figure 1) Tighten tilting stop bolt so picker will not be damaged while adjusting range of tilt.

2. (Figure 3) Using the hand tilt lever, raise gatherer points so that gatherer hinge point (long bolt which secures gatherer point to hinge bracket) is 13 to 14 inches above ground. Set range of tilting lever for the convenience of operator by moving the lift linkage on the lift arm to a different hole.

3. (Figure 1) With gatherer points raised, screw tilting stop bolt against fan support angle.

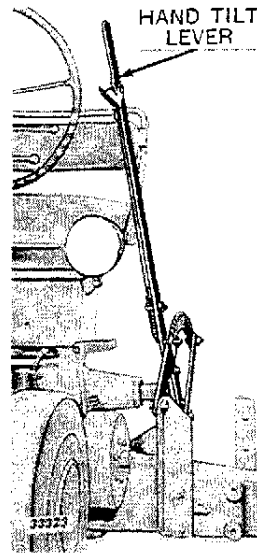

*Figure 3*

**John Deere Models "40" Tricycle, "40" Standard, "MT," and "M" Tractors and other tractors with comparable hydraulic control system.**

**To Adjust.**

1. (Figure 1) Tighten tilting stop bolt so damage will not occur to picker while adjusting range of tilt.

2. (Figure 4) Raise gatherer points with hydraulic lift of tractor so that the gatherer hinge point is 13 to 14 inches above the ground. Set hydraulic control lever stop on tractor so the lever cannot be moved beyond this height.

3. (Figure 1) With gatherer points raised, screw tilting stop bolt against support angle.

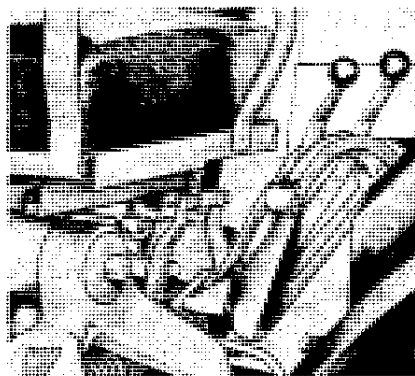

*Figure 4*

## GATHERERS

### Gatherer Points.

The gatherer points are hinged and, therefore, are able to follow the contour of the ground. They can be raised and locked in any one of a number of positions.

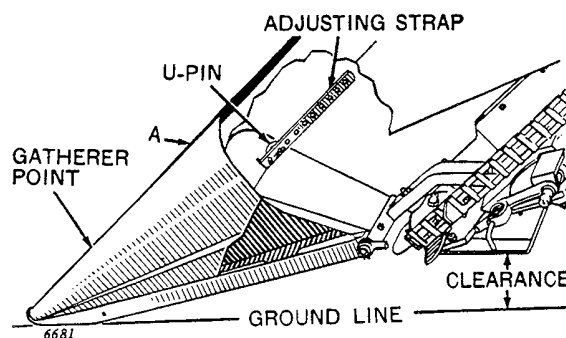

Figure 5

(See Figure 5) In ordinary conditions, the U-pin in adjusting strap should be placed at the hole which permits the gatherer point to complete a straight line from gatherer sheet to end of gatherer point (see "A") when machine is tilted to raise gatherer chains slightly above the ground. When operating, try to maintain this straight diagonal line, "A," of gatherer sheet and gatherer point with tip of point just touching the ground.

In muddy conditions or in snow, raise and lock gatherer points high enough to prevent the points from scooping material in throat opening, thereby clogging opening.

In down corn when stalks are over the rows or in weedy conditions it is sometimes advisable to attach fender sticks (see Page 42).

### Gatherer Chains.

The gatherer chains run well beyond the points of the snapping rolls. Chains can be run touching the ground if necessary to bring low hanging ears and down stalks into the snapping rolls.

**Timing.** (See Figure 9) The gatherer chains are timed so that the lugs of the outer chain (the long chain) are spaced midway between the lugs of the inner chain (the short chain). Do not remove links from either chain to tighten—chains will be out of time if you do. Run chains with flat side of lugs against the corn.



**Suggest:**

**If the above button click is invalid.**

**Please download this document**

**first, and then click the above link**

**to download the complete manual.**

**Thank you so much for reading**

**Tension** (See Figure 6) The gatherer chains should be tightened so they will have a 1-inch deflection when pulled away from guide plates. Too loose or too tight chains will cause excessive wear of guide plates.

**To Adjust:** Loosen nut "A" on tightener sprocket bolts. With hammer tap on flat edge of cam to move cam upward and move sprocket downward thereby tightening chain. Retighten nut. To loosen tension, move cam down.

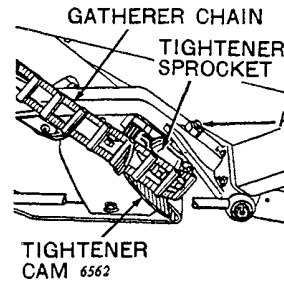

Figure 6

**Guide Plates.** Attaching brackets for guide plates have slotted holes so that plates can be adjusted in or out to properly place gatherer lugs.

#### Gatherer Throat Opening.

The gatherer throat opening should be 5-3/4 to 6-1/4 inches. This distance is measured between gatherer chain guide plates as shown in Figure 8.

**To Adjust:** (See Figure 7) To enlarge opening loosen lock nut, "A," and thread nut, "B," onto adjustable round brace and off to make opening smaller.

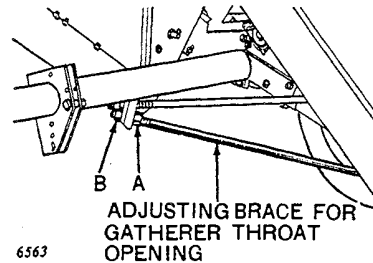

Figure 7

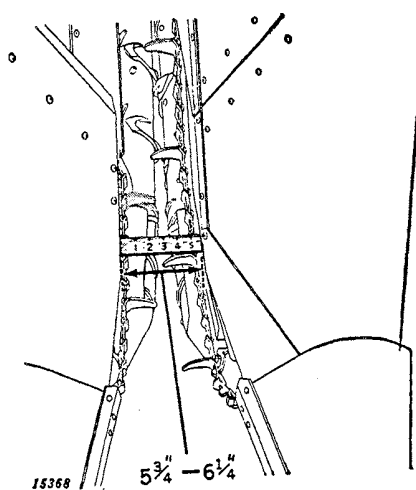

Figure 8

**<https://www.ebooklibonline.com>**

Hello dear friend!

Thank you very much for reading.

Enter the link into your browser.

The full manual is available for immediate download.

**<https://www.ebooklibonline.com>**