

JOHN DEERE
AG & TURF DIVISION

GATOR™ Compact Series Utility Vehicle
CX

OMM166171 J1

OPERATOR'S MANUAL



JOHN DEERE

Export Version
Printed in U.S.A.

Introduction

Thank You for Purchasing a John Deere Product

We appreciate having you as a customer and wish you many years of safe and satisfied use of your machine.

Using Your Operator's Manual

This manual is an important part of your machine and should remain with the machine when you sell it.

Reading your operator's manual will help you and others avoid personal injury or damage to the machine. Information given in this manual will provide the operator with the safest and most effective use of the machine. Knowing how to operate this machine safely and correctly will allow you to train others who may operate this machine.

If you have an attachment, use the safety and operating information in the attachment operator's manual along with the machine operator's manual to operate the attachment safely and correctly.

This manual and safety signs on your machine may also be available in other languages (see your authorized dealer to order).

Sections in your operator's manual are placed in a specific order to help you understand all the safety messages and learn the controls so you can operate this machine safely. You can also use this manual to answer any specific operating or servicing questions. A convenient index located at the end of this book will help you to find needed information quickly.

The machine shown in this manual may differ slightly from your machine, but will be similar enough to help you understand our instructions.

RIGHT-HAND and LEFT-HAND sides are determined by facing in the direction the machine will travel when going forward. When you see a broken line (-----), the item referred to is hidden from view.

Before delivering this machine, your dealer performed a predelivery inspection to ensure best performance.

Machine Use

This utility vehicle is designed for light-duty personal and commercial use. The towing, hauling and payload capacity of this machine make it ideal to assist homeowners around their properties and for light-duty commercial applications. Use in any other way or beyond the stated specifications of this machine is considered contrary to the intended use.

This machine is not intended for use in forestry operations. The operator station does not provide adequate protection

to the occupants in that environment.

This machine is not intended for use in spraying operations where hazardous substances may be used.

The manufacturer accepts no liability for damage or injury resulting from this misuse, and these risks must be borne solely by the user. Compliance with and strict adherence to the conditions of operation, service and repair as specified by the manufacturer also constitute essential elements for the intended use.

This machine should be operated, serviced and repaired only by persons familiar with all its particular characteristics and acquainted with the relevant safety rules (accident prevention). The accident prevention regulations, all other generally recognized regulations on safety and occupational medicine and the road traffic regulations must be observed at all times.

Setting fuel delivery beyond published factory specifications or otherwise overpowering will result in loss of warranty protection for this machine.

Any arbitrary modifications carried out on this machine will relieve the manufacturer of all liability for any resulting damage or injury.

Special Messages

Your manual contains special messages to bring attention to potential safety concerns, machine damage as well as helpful operating and servicing information. Please read all the information carefully to avoid injury and machine damage.



CAUTION: Avoid injury! This symbol and text highlight potential hazards or death to the operator or bystanders that may occur if the hazards or procedures are ignored.

IMPORTANT: Avoid damage! This text is used to tell the operator of actions or conditions that might result in damage to the machine.

NOTE: General information is given throughout the manual that may help the operator in the operation or service of the machine.

Product Identification

Record Identification Numbers

GATOR Compact Series Utility Vehicle

CX PIN (100001-)

If you need to contact your John Deere dealer for information on servicing, always provide the product model and identification numbers.

You will need to locate the model and serial number for the machine and for the engine of your machine and record the information in the spaces provided below.

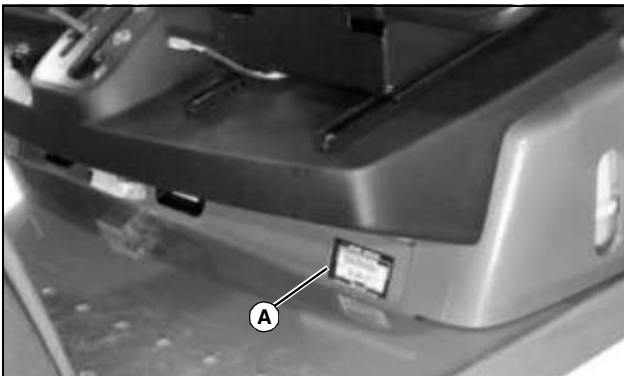

MX34003a

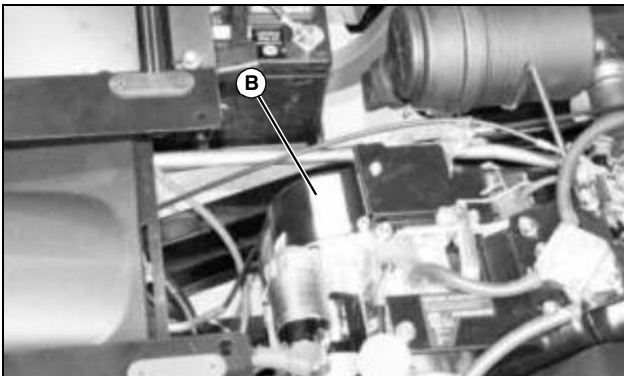

MX34004

DATE OF PURCHASE:

DEALER NAME:

DEALER PHONE:

PRODUCT IDENTIFICATION NUMBER (A):

ENGINE SERIAL NUMBER (B):

<https://www.ebooklibonline.com>

Hello dear friend!

Thank you very much for reading.

Enter the link into your browser.

The full manual is available for immediate download.

<https://www.ebooklibonline.com>

Table of Contents

Safety Labels	1
Safety Labels	2
Safety	5
Machine Cleanout.....	10
Operating - Controls	12
Operating.....	13
Replacement Parts	23
Service Intervals.....	24
Service Lubrication.....	25
Service Engine	26
Service Transmission.....	31
Service Electrical.....	35
Service Miscellaneous.....	38
Troubleshooting	44
Storage	47
Assembly	49
Specifications	51
Declaration of Conformity	54
Index.....	55

Original Instruction

All information, illustrations and specifications in this manual are based on the latest information at the time of publication. The right is reserved to make changes at any time without notice.

COPYRIGHT© 2011

Deere & Co.

John Deere Ag & Turf Division

All rights reserved

Previous Editions

COPYRIGHT©

OMM166171 J1 - English

Safety Labels

Safety Label Location

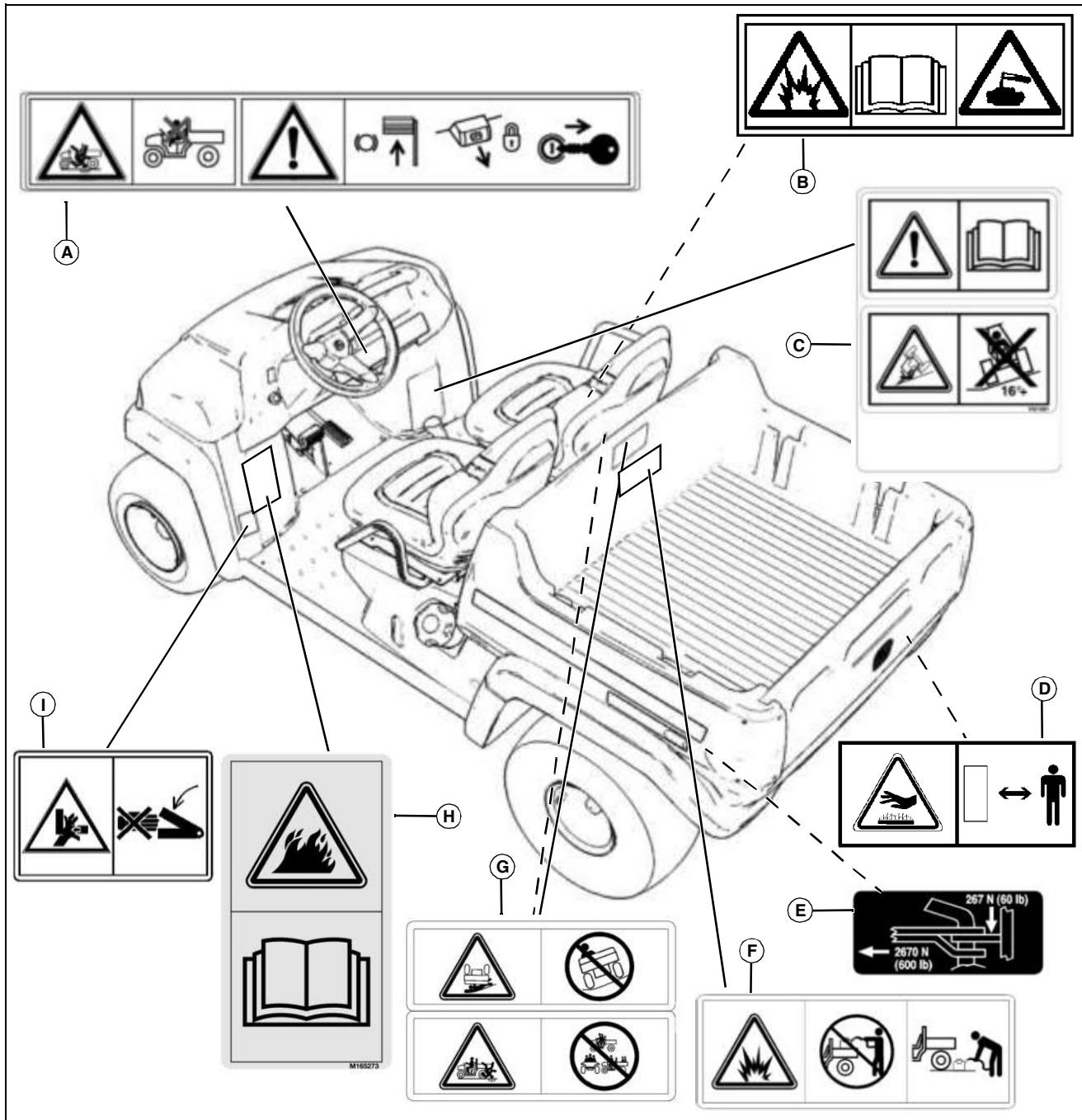

MX49868

F - WARNING - M151630

G - WARNING - M153485

H - CAUTION - M165273

I - CAUTION - M120057

Picture Note: Use label number listed in table below to locate complete text of safety label message following this illustration.

A - CAUTION/WARNING - M152241

B - DANGER/CAUTION - M133159

C - WARNING - VG11561

D - WARNING - GX21121

E - DRAWBAR - M152243

Safety Labels



Pictorial Safety Signs

At several important places on this machine safety signs are affixed intended to signify potential danger. The hazard is identified by a pictorial in a warning triangle. An adjacent pictorial provides information how to avoid personal injury. These safety signs, their placement on the machine and a brief explanatory text are shown in this Safety section.

There can be additional safety information contained on parts and components sourced from suppliers that is not reproduced in this operator's manual.

Warning M152241

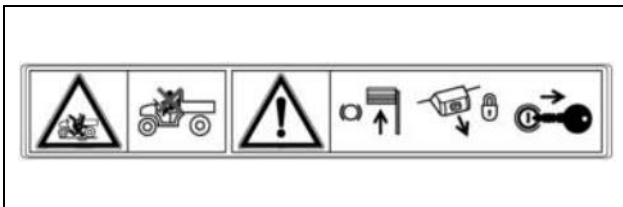

M152241

Young Drivers Increase Chance of Death

- Young drivers may not be able to control vehicle.
- No drivers younger than 16 years old.

Before Leaving Vehicle:

- Stop engine
- Set park brake
- Remove key

WARNING M133159

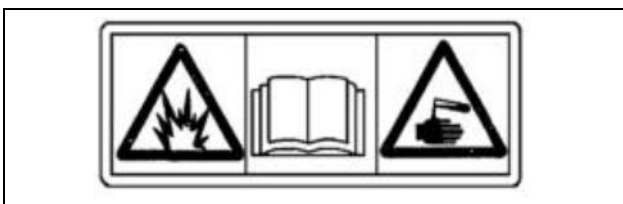

M133159

Avoid Injury From Battery Gases and Acids

- Batteries contain explosive gases and sulfuric acid. Use extreme caution when handling battery.
- Read operator's manual for all safety information before handling battery.
- Use extreme caution when handling battery.

Rollover or Falling Off May Cause Death

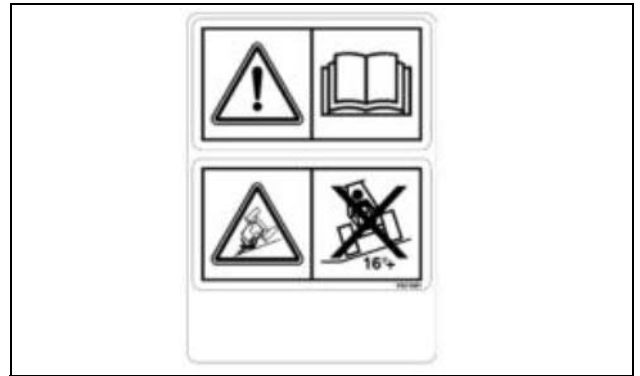

VG11561

- Read operator's manual.
- Drive very slowly when turning.
- Always use brakes going down a slope. Vehicle can take-off (freewheel) downhill.
- Do not drive where machine could slip or tip. Do not drive on slope with more than a 16° incline.
- Reduce speed and load on rough or hilly ground.
- No loads heavier than 400 lbs (180 kg).
- Spread loads evenly. Tie loads down.

WARNING GX21121

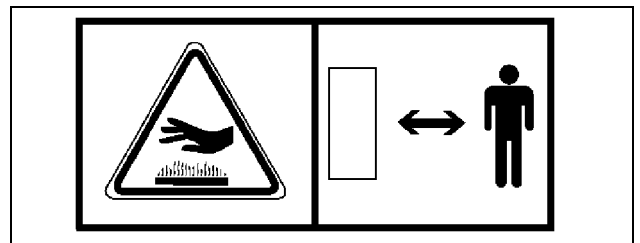

GX21121

Warning - Hot Surfaces

- Keep away from hot surfaces.

Safety Labels

Drawbar Load

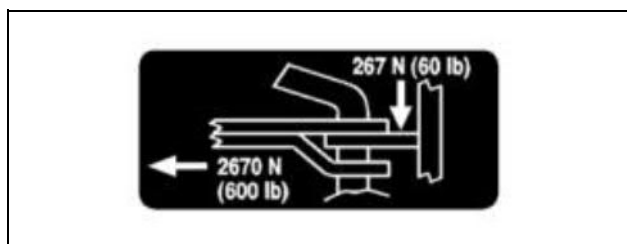

M152243

Do not exceed recommended drawbar loads stated on label.

- Horizontal 2670 N (600 lb-force)
- Vertical 267 N (60 lb-force)

WARNING M151630

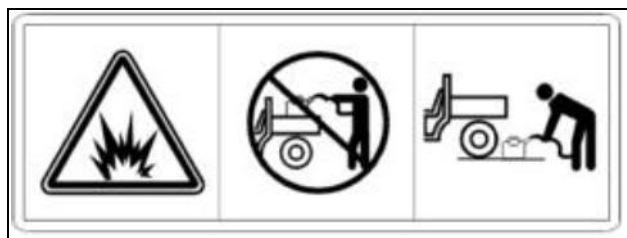

M151630

AVOID INJURY FROM EXPLOSION

- Do not place gas container inside cargo box bed when filling.
- Place gas container on ground when filling.

Warning M153485



M153485

ROLLOVER OR FALLING OFF MAY CAUSE DEATH

- Read operator's manual.
- Drive very slowly when turning.
- Always use brakes when going down a slope. Vehicle can take-off (freewheel) downhill.
- No loads heavier than 400 lbs (180 kg).
- Reduce speed and load on rough or hilly ground.

Prevent Equipment Fires

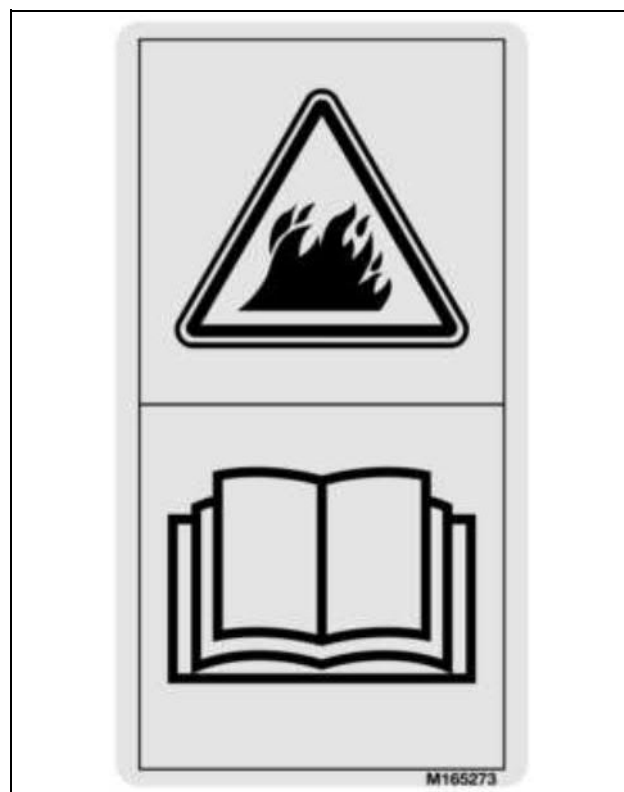

M165273

M165273

- Clean and inspect the entire machine.
- Carefully read Operator's Manual Machine Cleanout section for details.

Safety Labels

CAUTION M120057

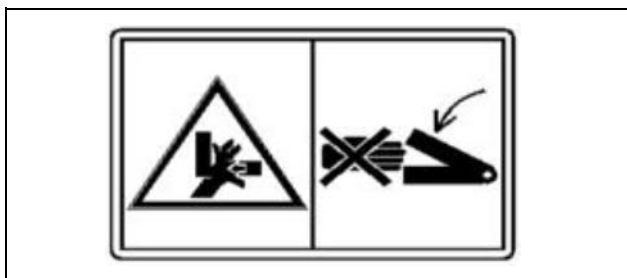

M120057

HELP PREVENT INJURY WHEN DUMPING LOADS

- Operate dump with machine stationary and parking brake locked. Never dump while moving.
- Operate dump on level ground only.
- Operate dump from operator's seat only.
- Do not place hands behind seat when lowering box.
- Refer to Operator's Manual for correct load distribution.

Safety

Operating Safely

- Read, understand and follow all instructions in the operator's manual and on the machine before starting.
- Do not misuse the utility vehicle. It is a utility vehicle, not a recreation vehicle.
- The utility vehicle is not intended for use on highways or public roads. It is to be used for off-road use only.
- Slow down and be careful of traffic when operating near or crossing roadways. Use care when approaching blind corners, shrubs, trees, or other objects that may obscure vision.
- The operator should always make sure that the passenger is aware of correct safety procedures while riding in the utility vehicle.
- The passenger should always use the hand holds.
- Horseplay or recreational riding can lead to accidents, severe bodily injury or death.
- Sit on the center of the seat and keep both feet within the foot platform perimeter. Clean foot platform if dirty, and remove any debris from around foot controls.
- Check for debris in engine compartment, especially around brake linkage on each side of the transaxle.
- Always use both hands for steering.
- Know location of controls and how and what they operate.
- Never operate utility vehicle while standing.
- Never operate utility vehicle with the cargo box raised.
- Check brake action before beginning vehicle operation. Adjust or service the brakes as necessary.
- To provide adequate braking ability and traction, do not tow any attachment or loaded trailer unless the cargo box is fully loaded.
- Inspect vehicle before operating. Be sure hardware is tight. Repair or replace damaged, badly worn, or missing parts. Be sure guards and shields are in good condition and fastened in place. Make any necessary adjustments before operating.
- Do not leave vehicle unattended when it is running.
- Operate during daylight or with good artificial light and if you drive at night, use the lights.
- Do not operate vehicle if under the influence of alcohol or other drugs.
- Avoid sudden starts, stops, or turns.
- Always use a level turn-around area.
- Do not wear radio or music headphones. Safe service and operation require your full attention.

Parking Safely

1. Stop vehicle on a level surface, not on a slope.
2. Lock park brake.
3. Stop engine.
4. Remove key.
5. Before you leave the operator's seat, wait for engine and all moving parts to stop.
6. Disconnect the negative battery cable or remove the spark plug wire (for gasoline engines) before servicing the machine.

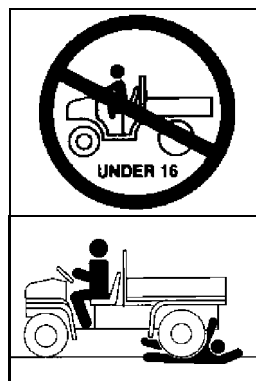

Protect Children and Prevent Accidents

- This utility vehicle should not be operated by anyone under the age of 16 years.
- Young drivers may not be physically able to control the machine or may not be mature enough to make safe driving decisions.
- Do not allow children to ride as a passenger in this vehicle. Children may not be able to sit safely in the passenger seat and use handholds properly.
- Passengers should always use the handholds while the vehicle is moving.
- The seat belt installed on utility vehicles with an Occupant Protective Structure (OPS) is not designed to restrain a child.
- Never carry passengers, especially children, in the cargo box area. Do not tow children in a cart or trailer.
- Never assume that children will remain where you last saw them. Stay alert to the presence of children.
- Before backing or turning, look behind and around the utility vehicle for children.
- Be alert at all times, drive forward and in reverse carefully. People, especially children, can move quickly into an area of operation.
- Use extra care when coming to blind corners, shrubs, trees, or other objects that may block vision.
- Misuse and recreational riding can lead to accidents, severe bodily injury or death.

Safety

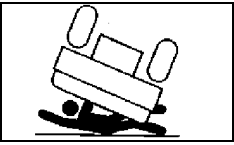

Avoid Excessive Speeds

- Always travel at a speed that is safe and proper for the terrain, visibility and operating conditions, and your experience operating the machine.

- Use caution when operating the machine in reverse. Use a slow speed and do not make sharp turns. Always look behind before backing.
- Never travel at excessive speeds on slopes, either going up or down. Use a slow speed and do not make sharp turns. Become experienced driving the machine on small slopes before driving on larger hills.

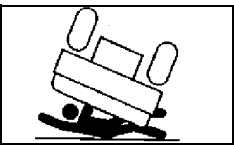

Avoid Tipping

Accidents resulting in serious injury or death can occur from tipping the utility vehicle. Observe the following practices to help prevent accidents:

- Do not misuse the utility vehicle. The utility vehicle is not designed for recreational riding.
- Drive very slowly when turning. Sharp turns could cause the utility vehicle to tip over.
- Reduce speed and exercise extreme caution on slopes or on rough ground.
- Do not overload vehicle and avoid shifting loads. Reduce load when operating over rough or hilly terrain.
- Do not stop or start suddenly when going uphill or downhill. Be especially cautious when changing direction on slopes.
- Stay alert for holes, rocks, and other hidden hazards in the terrain.
- Keep away from drop-offs, ditches, embankments, as well as ponds and other bodies of water. The machine could suddenly roll over if a wheel goes over the edge of a cliff or ditch or if the edge caves in.
- Keep front wheels straight at crest of hill or going over bumps.
- When descending a hill, remove foot from accelerator and apply brakes to reduce speed and maintain control.
- Do not make changes or modifications to the utility vehicle.

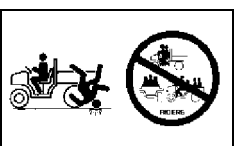

Keep Riders Off Vehicle

- Seating is provided for operator and one adult passenger.

- Never allow riders in the cargo box or other areas where seats are not provided.
- Riders on vehicle are subject to injury such as being struck by foreign objects or being thrown off of the vehicle and severely injured or killed.
- Riders affect the operator's ability to control the vehicle as well as its center of gravity. Also, riders could obstruct the operator's view resulting in the vehicle being operated in an unsafe manner.

Transport Loads Safely

- Be sure load is evenly distributed in cargo box.
- Do not load above load guard.
- Securely anchor all loads in cargo box.
- Reduce cargo box load when operating on rough or hilly terrain.

Towing Loads Safely With Utility Vehicle

- To provide adequate braking ability and traction, weight of towed load (trailer plus cargo) must never exceed the vehicle payload (operator plus passenger plus cargo box load).
- Do not tow a load that exceeds the maximum allowable towing load for this vehicle, as specified in this operator's manual.
- Stopping distance increases with speed and weight of towed load. Travel slowly and allow extra time and distance to stop.
- Tow load at a speed slow enough to maintain control.
- Excessive towed load can cause loss of traction and loss of control on slopes. Reduce towed weight when operating on slopes.
- Never allow children or others in or on towed equipment.
- Use only approved hitches. Tow only with a machine that has a hitch designed for towing. Do not attach towed equipment except at the approved hitch point.
- Follow the manufacturer's recommendations for weight limits for towed equipment and towing on slopes.
- If you cannot back up a slope with a towed load, the slope is too steep to operate on with the towed load. Reduce the towed load or do not operate.
- Do not turn sharply. Use additional caution when turning or operating under adverse surface conditions. Use care when reversing.
- Do not shift to neutral and coast downhill.

Safety

Before Driving

1. Clean foot platform if dirty, and remove any debris from around foot controls. Sit on the center of seat and keep both feet inside foot platform perimeter.
2. Inspect utility vehicle for signs of wear or damage.
3. All safety equipment must be in good condition and fastened in place:
 - Lights.
 - Shields.
 - Safety start devices.
4. Before moving, check around utility vehicle, be sure no one is near it.
5. Inspect mechanical condition of your vehicle before each use to minimize chance of injury or being stranded. Remember, you can ride farther in an hour than you can walk in a day.

Be sure to check condition of tires and wheels, wheel hardware torque, and maintain proper tire pressure.
6. Securely anchor all loads.

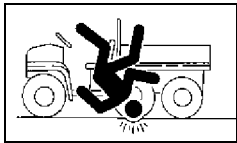

Driving On Rough Terrain

- Use existing trails. Avoid terrain such as dangerous slopes and impassable swamps. Watch carefully for bumps, holes, ruts, loose terrain, or other obstacles.
- Look ahead at terrain. Know what is coming and be prepared to react. Be alert for hazards.
- Keep front wheels straight at crest of hill or going over bumps.
- Reduce speed according to trail, terrain, and visibility conditions.
- The passenger should always use the hand holds.

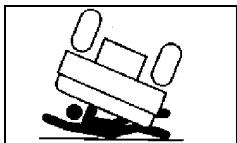

Climbing Or Descending A Hill

- Always use the brakes when going down slopes, the utility vehicle can speed up (freewheel) going down a slope. Engine or clutch braking effect is minimal.
- Balance loads evenly and secure them. Braking could shift the load and affect vehicle stability.
- Sit on center of seat and keep both feet within foot platform.

- Never drive past the limit of visibility. Slow down near crest of hill until getting a clear view of the other side. Never go over the top of any hill at a high speed. An obstacle, sharp drop, another vehicle or person, could be on the other side of the hill.
- Keep front wheels straight at crest of hill or going over bumps.
- Do not stop or start suddenly when going uphill or downhill. Be especially cautious when changing direction on slopes.
- If vehicle stops or loses power going up a hill, lock park brake to hold vehicle on slope. Maintain direction of travel and release brake slowly. Back straight down hill slowly while maintaining control. Do not turn vehicle sideways. Vehicle is more stable in a straight forward or rearward position.
- When descending a hill, remove foot from accelerator and apply brakes to reduce speed and maintain control.

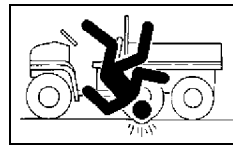

Driving Across Slopes

- Reduce speed and use caution on slopes and in sharp turns.
- Stay alert for holes, rocks and other hidden hazards in the terrain.
- When riding on soft terrain, turn front wheels slightly uphill to keep utility vehicle on a straight line across the hill.
- If utility vehicle begins to tip, turn front wheel downhill to gain control before proceeding.

Riding Through Water

- Avoid water whenever possible. If drive belt becomes wet, slippage will occur and vehicle will lose power.
- Never cross any body of water where depth may be unknown to the operator. As an operational guideline, deep water is considered anything in excess of 152 mm (6 in.) in depth. Tires may float, making it difficult to maintain control.
- Choose a course within the waterway where both banks have a gradual incline. Cross at a point known to be safe.
- Proceed at a slow steady speed to avoid submerged obstacles and slippery rocks.
- Avoid water crossings where the operation of a utility vehicle may cause damage to waterway beds or erode waterway shoreline.
- Never operate this vehicle in fast-moving water.
- Stopping ability of vehicles with external disk brakes may be affected after driving through water. If necessary, apply

Safety

brakes several times to dry them out.

Checking Wheel Hardware

- A serious accident could occur causing serious injury if wheel hardware is not tight.
- Check wheel hardware tightness often during the first 100 hours of operation.
- Wheel hardware must be tightened to specified torque using the proper procedure anytime it is loosened.

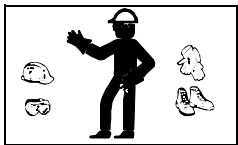

Wear Appropriate Clothing

- Wear close fitting clothing and safety equipment appropriate for the job.
- Certain operating conditions may dictate that the operator and any passenger wear appropriate safety equipment while operating the vehicle. Be prepared for any existing and potential conditions before operating machine.
- Local safety or insurance regulations may require additional safety equipment such as eye protection or a hard hat.
- Always wear substantial footwear and long trousers. Do not operate the equipment when barefoot or wearing open sandals.



Practice Safe Maintenance

- Only qualified, trained adults should service this machine.
- Understand service procedure before doing work. Keep area clean and dry.
- Never lubricate, service, or adjust machine while it is moving. Keep safety devices in place and in working condition.
- Keep hands, feet, clothing, jewelry, and long hair away from any moving parts, to prevent them from getting caught.
- Disconnect battery(ies) or remove spark plug wire (for gasoline engines) before making any repairs.
- Keep all nuts and bolts tightened.
- Securely support any machine elements that must be raised for service work. Lock service latches before working on machine with raised attachments.
- Never run engine unless park brake is locked.
- Keep all parts in good condition and properly installed. Fix

damage immediately. Replace worn or broken parts. Replace all worn or damaged safety and instruction decals.

- To prevent fires, remove any buildup of grease, oil, or debris from the machine, especially the engine.
- Do not modify machine or safety devices. Unauthorized modifications may impair its function and safety.
- Do not wear radio or music headphones while servicing the machine. Safe service requires your full attention.
- Disconnect battery ground cable(s) (-) on the machine or remove attachment from machine before welding on the machine.

Prevent Fires

- Machine fires and structure fires can occur if a machine is stored before allowing it to cool, if debris is not removed from critical areas of the machine, or if machine is stored near combustible materials.
- Remove grass and debris from engine compartment and muffler area, before and after operating machine.
- Always shut off fuel when storing or transporting machine, if the machine has a fuel shutoff.
- Do not store machine near an open flame or source of ignition, such as a water heater or furnace.
- Check fuel lines, tank, cap, and fittings frequently for cracks or leaks. Replace if necessary.

Do Not Modify Machine

Do not make any unauthorized modifications to the machine in any way.

Modifications can result in making the machine unstable, increasing the possibility of rollover causing severe bodily injury or death.



Tire Safety

Explosive separation of a tire and rim parts can cause serious injury or death:

- Do not attempt to mount a tire without the proper equipment and experience to perform the job.
- Always maintain the correct tire pressure. Do not inflate the tires above the recommended pressure. Never weld or heat a wheel and tire assembly. The heat can cause an increase in air pressure resulting in a tire explosion. Welding can structurally weaken or deform the wheel.

Safety

- When inflating tires, use a clip-on chuck and extension hose long enough to allow you to stand to one side and NOT in front of or over the tire assembly.
- Check tires for low pressure, cuts, bubbles, damaged rims or missing lug bolts and nuts.

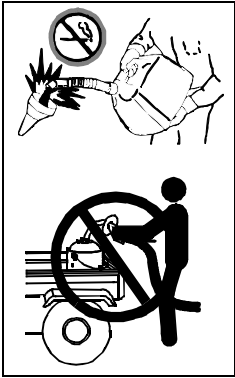

Handling Fuel Safely

To avoid personal injury or property damage, use extreme care in handling fuel. Fuel is extremely flammable and fuel vapors are explosive:

- Extinguish all cigarettes, cigars, pipes, and other sources of ignition.
- Use only approved non-metal, portable fuel containers. If using a funnel, make sure it is plastic and has

no screen or filter.

- Never remove the fuel tank cap or add fuel with the engine running. Allow engine to cool before refueling.
- Never add fuel to or drain fuel from the machine indoors. Move machine outdoors and provide adequate ventilation.
- Clean up spilled fuel immediately. If fuel is spilled on clothing, change clothing immediately. If fuel is spilled near machine, do not attempt to start the engine but move the machine away from the area of spillage. Avoid creating any source of ignition until fuel vapors have dissipated.
- Never store the machine or fuel container where there is an open flame, spark, or pilot light such as on a water heater or other appliance.
- Prevent fire and explosion caused by static electric discharge. Static electric discharge can ignite fuel vapors in an ungrounded fuel container.
- Never fill containers inside a vehicle or on a truck or trailer bed with a plastic liner. Always place containers on the ground away from your vehicle before fueling.
- Remove fuel-powered equipment from the truck or trailer and refuel it on the ground. If this is not possible, then refuel such equipment with a portable container, rather than from a fuel dispenser nozzle.
- Keep the nozzle in contact with the rim of the fuel tank or container opening at all times until the fueling is complete. Do not use a nozzle lock-open device.
- Never overfill fuel tank. Replace fuel tank cap and tighten securely.
- Replace all fuel container caps securely after use.
- For gasoline engines, do not use gas with methanol. Methanol is harmful to your health and to the environment.

Handling Waste Product and Chemicals

Waste products, such as, used oil, fuel, coolant, brake fluid, and batteries, can harm the environment and people:

- Do not use beverage containers for waste fluids - someone may drink from them.
- See your local Recycling Center or authorized dealer to learn how to recycle or get rid of waste products.
- See your local Recycling Center or authorized dealer to learn how to put your machine out of service at the end of the machine's service life.

Machine Cleanout

Prevent Fires

- Besides routine maintenance, one of the best ways to keep your John Deere equipment running efficiently and to reduce fire risk is to regularly remove debris buildup from the machine.
- Please review these recommendations with all operators. See your John Deere dealer with questions.
- Always follow all safety procedures posted on the machine and in this operator manual. Before carrying out any inspection or cleaning, always shut off engine, lock parking brake and remove ignition key.
- After operating, allow machine to cool in an open area before cleaning or storing. Do not park machine near flammable materials such as wood, cloth or chemicals.
- Empty cargo box completely before storing.
- Frequency of these inspections and cleaning will vary depending on a number of factors including operating conditions, machine configuration, operating speeds and weather conditions particularly dry, hot and windy conditions. When you are operating in these conditions, inspect and clean these areas frequently throughout the day.
- Check engine bay frequently if the cargo box has being loaded with any material that could have spilled over the sides.
- Wind direction, terrain type and moisture content of surrounding vegetation can effect where and how much debris accumulates.
- Debris can accumulate anywhere on the machine, especially on horizontal surfaces.
- Keeping engine area clean will provide the greatest impact on fire prevention. Other areas requiring regular inspection and cleaning include under skid plates (if equipped), behind wheel rims, wire harness, hose/line routings, etc. Compressed air, leaf blowers or high pressured water can assist keeping these areas clean.
- Adding a windshield, canopy or other attachments can change air flow around the vehicle. Always check for debris buildup after adding attachments.
- Primary areas that must be inspected and cleaned on the machine include (See Safety Label Section):

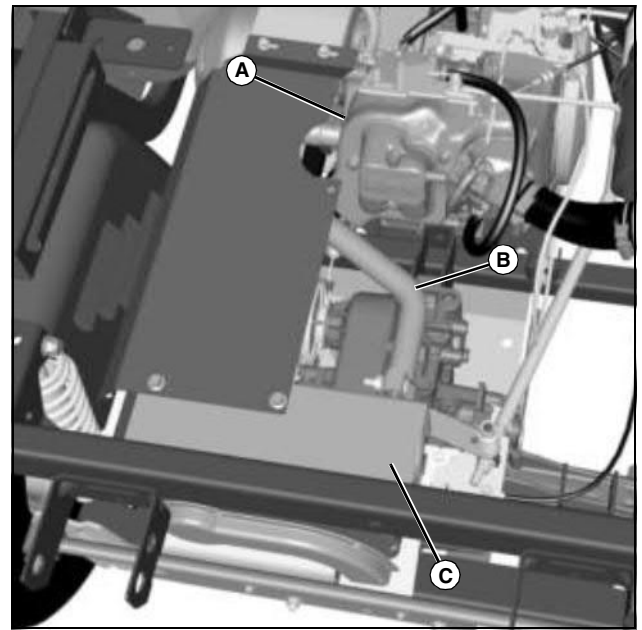

MX49857

a. Exhaust manifold (A), muffler pipe (B), muffler, and muffler shield (C).

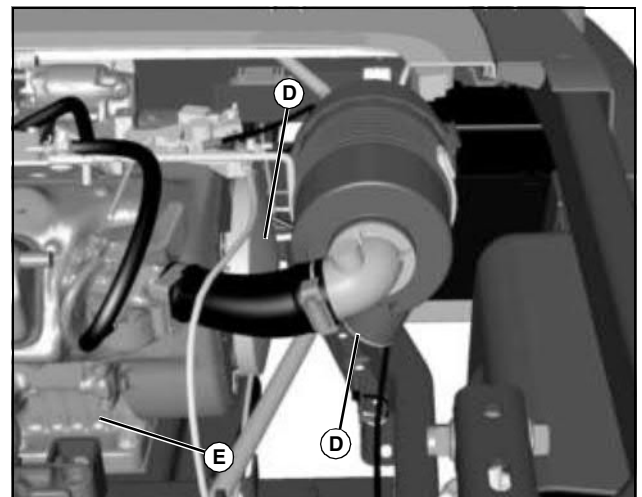

MX49858

b. Engine intake screens (D), cooling fins (E) and oil cooler (if equipped).

Machine Cleanout

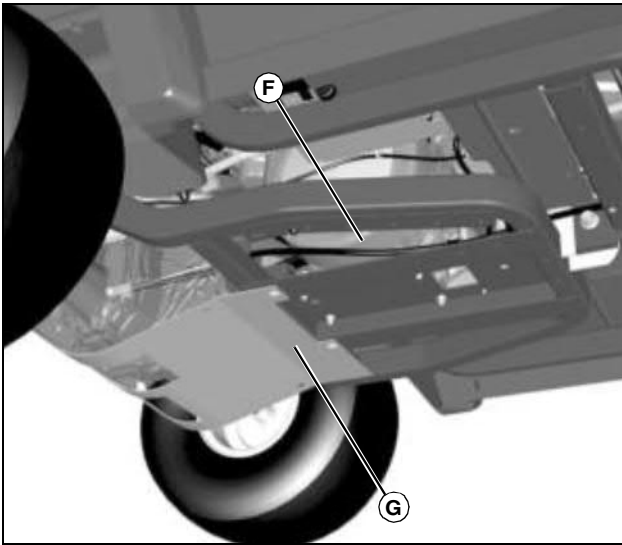

MX49859

c. Between engine (F) and skid plates (G) (if equipped).

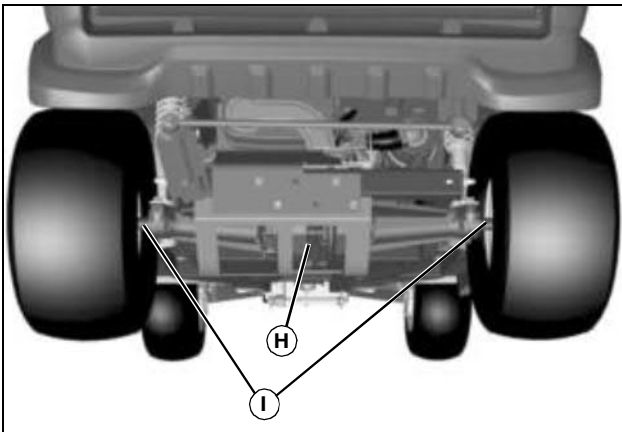

MX49860

d. On or near transmission (H) and driveline (I).

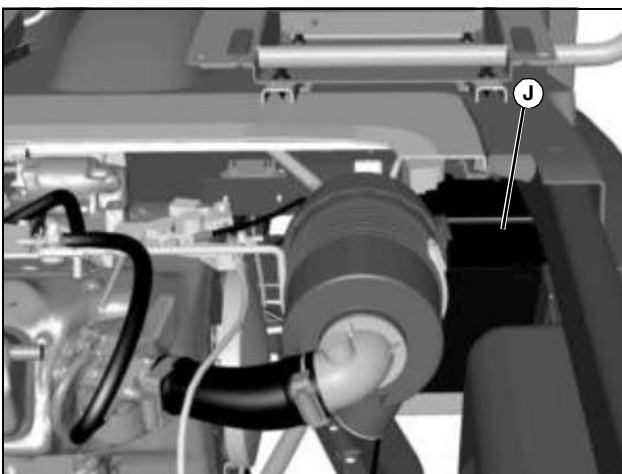

MX49858

e. Battery (J) and related wiring harnesses.

- Excess lubrication or fuel/oil leaks or spills on the machine can also serve as collection sites for debris. Prompt machine repair and oil/fuel cleanup will minimize the potential for debris collection and reduced cooling throughout machine life.
- Bearing failures or overheating can result in a fire. To reduce this risk, always follow the instructions in the machine operator's manual regarding lubrication intervals and locations. Washing the machine while warm may also reduce bearing life and increase potential for premature bearing failure.
- Always shut off fuel when storing or transporting machine, if the machine has a fuel shutoff.

Operating - Controls

Operator Station Controls

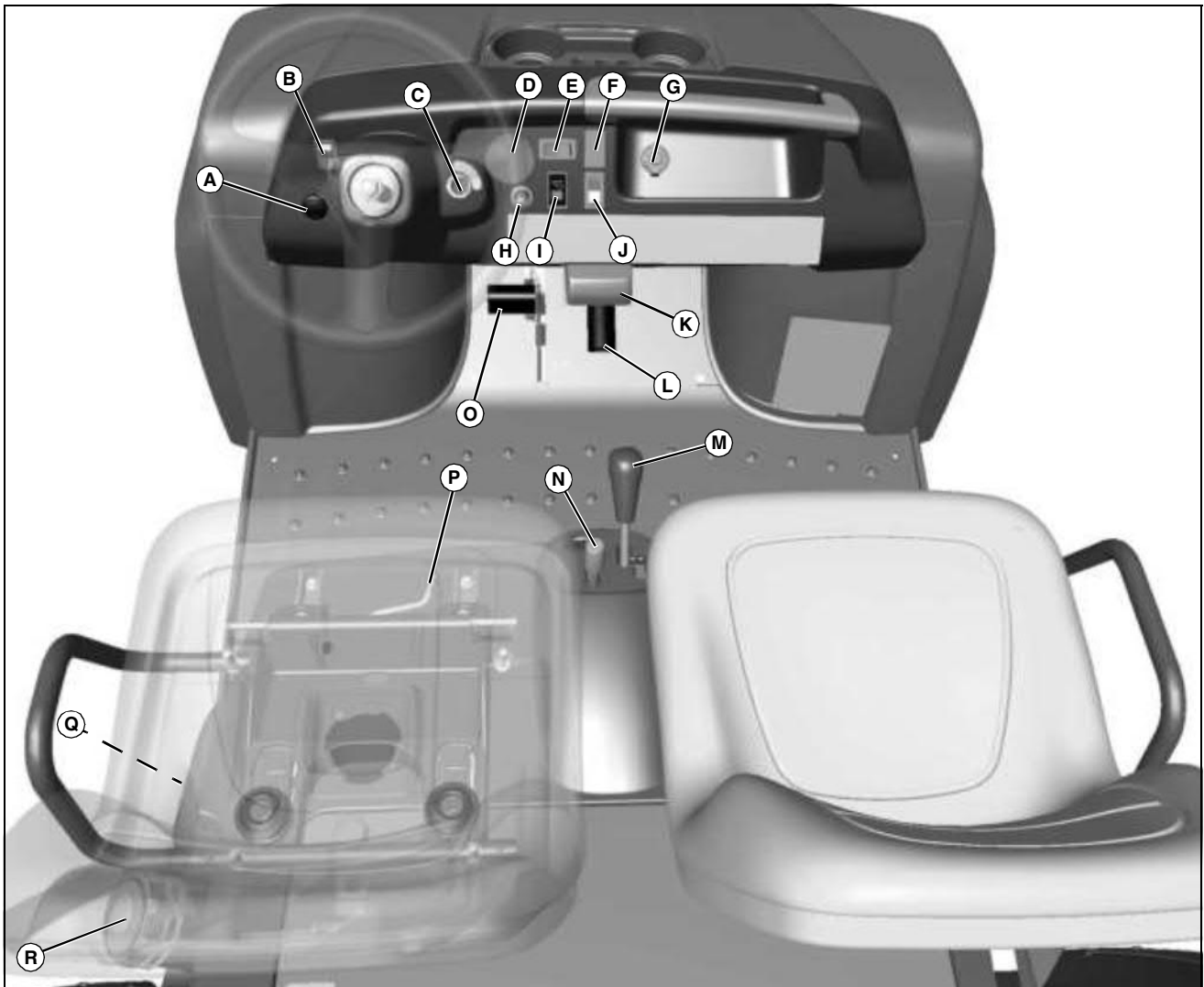

MX45727

Picture Note: Some controls may not be installed on your machine.

Key	Description	Key	Description
A	Choke Knob	J	Front Blade Lift/Lower Switch
B	Cargo Box Power Lift Switch	K	Park Brake Lock
C	Key Switch	L	Accelerator Pedal
D	Hour Meter	M	Gear Shift Lever
E	Turn Signal Switch	N	Traction Assist (Differential Lock) Lever
F	Hazard Lights Switch	O	Brake Pedal
G	12V DC Accessory Outlet	P	Lever, Seat Adjust
H	Horn Switch	Q	Fuel Level Sight Gauge
I	Headlight Switch	R	Fuel Tank Cap

Operating

Daily Operating Checklist

- Test safety systems.
- Check tire pressure.
- Check fuel level.
- Check engine oil level.
- Check transmission oil level.
- Remove grass and debris from machine.
- Clean air intake screen.
- Check area below machine for leaks.

Avoid Damage to Plastic and Painted Surfaces

- Do not wipe plastic parts unless rinsed first. Using a dry cloth may cause scratches.
- Insect repellent spray may damage plastic and painted surfaces. Do not spray insect repellent near machine.
- Be careful not to spill fuel on machine. Fuel may damage surface. Wipe up spilled fuel immediately.
- Prolonged exposure to sunlight will damage hood surfaces.

Adjusting Seat

Adjusting Seat Position

1. Stop machine and move gear shift lever to N (neutral) position.
2. Lock park brake.



CAUTION: Avoid injury! Never adjust seat while machine is moving. Stop machine before adjusting seat to prevent loss of machine control.



MX34008

3. Sit on seat and move lever (A) to the left.
4. Slide seat forward or rearward to desired position.
5. Release lever.

Using Hand Holds



MX30452

Hand holds (A) are provided for passenger balance when driving over rough terrain. Use dash bar and side rails on seats for stability.



Suggest:

If the above button click is invalid.

Please download this document

first, and then click the above link

to download the complete manual.

Thank you so much for reading

Operating

Testing Safety Systems

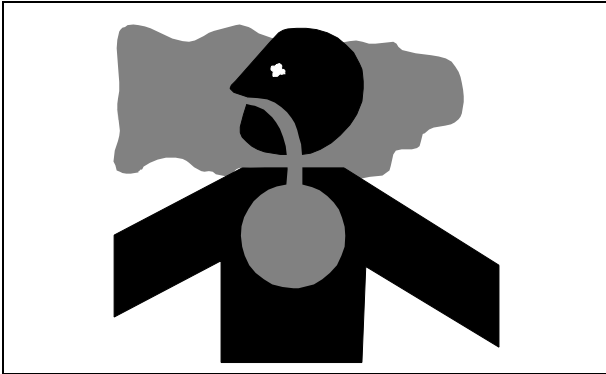

CAUTION: Avoid injury! Engine exhaust fumes contain carbon monoxide and can cause serious illness or death.

- Move the machine to an outside area before running the engine.
- Do not run an engine in an enclosed area without adequate ventilation.
- Connect a pipe extension to the engine exhaust pipe to direct the exhaust fumes out of the area.
- Allow fresh outside air into the work area to clear the exhaust fumes out.

The safety systems installed on your machine should be checked before each machine use. Be sure you have read the machine operator manual and are completely familiar with the operation of the machine before performing these safety system checks.

Use the following checkout procedures to check for normal operation of machine.

If there is a malfunction during one of these procedures, do not operate machine. **See your authorized dealer for service.**

Perform these tests in a clear open area. Keep bystanders away.

Testing the Safety Start System

1. Sit on the operator's seat.
2. Put key in STOP position.
3. Lock park brake.
4. Move gear shift lever to forward position.
5. Move key to start position. Engine should not crank. Turn key off.

6. Move gear shift lever to reverse position.
7. Move key to start position. Engine should not crank. Turn key off.

Using Park Brake

Locking Park Brake

CAUTION: Avoid injury! Children or bystanders may attempt to move or operate an unattended machine.

Always lock the park brake and remove the key before leaving the machine unattended.

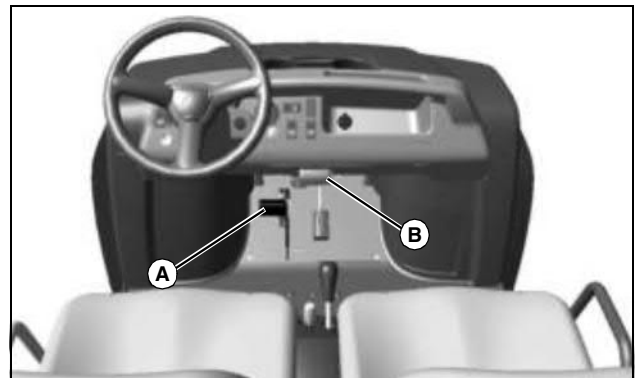

MX30452

1. Push and hold down brake pedal (A).
2. Pull out park brake lever (B) to lock park brake.
3. Release brake pedal. Pedal should stay down and park brake lever should stay out in locked position.

Unlocking Park Brake

1. Push and hold down brake pedal (A).
2. Park brake lever (B) should release and move in to unlock park brake.
3. Release brake pedal. Pedal should come up to operating position.

<https://www.ebooklibonline.com>

Hello dear friend!

Thank you very much for reading.

Enter the link into your browser.

The full manual is available for immediate download.

<https://www.ebooklibonline.com>