



# 6602 COMBINES



JOHN DEERE

## OPERATORS MANUAL 6602 COMBINES

OMH85751 B3 English

**OMH85751 B3**

LITHO IN THE U.S.A.  
ENGLISH

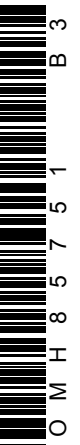



## To the Purchaser

---

This new combine was carefully designed and manufactured to give years of dependable service. To keep it running efficiently, read the instructions in this operator's manual. Each section is clearly identified so you can easily find the information you need—whether it is operation, lubrication, or service. Read the Table of Contents to learn where each section is located. Use the alphabetical index for fast reference.

 This safety alert symbol identifies important safety messages in this manual. When you see this symbol, be alert to the possibility of personal injury and carefully read the message that follows.

In addition to the equipment furnished with your combine, attachments are available to help you do a better job in special crop conditions. These are described in the attachments section of this manual and can be purchased from your John Deere dealer.

"Right-hand" and "left-hand" sides are determined by facing in the direction the combine will travel when in use. The radiator end of the engine is referred to as the "front," the flywheel end as the "rear."

Record your combine serial numbers in the space provided on page 148. Your dealer needs this information to give you prompt, efficient service when you order parts or attachments. If your combine requires replacement parts, go to your John Deere dealer where you can obtain genuine John Deere parts—accept no substitutes.

The warranty on this combine appears on your copy of the purchase order which you should have received from your dealer when you purchased the combine.

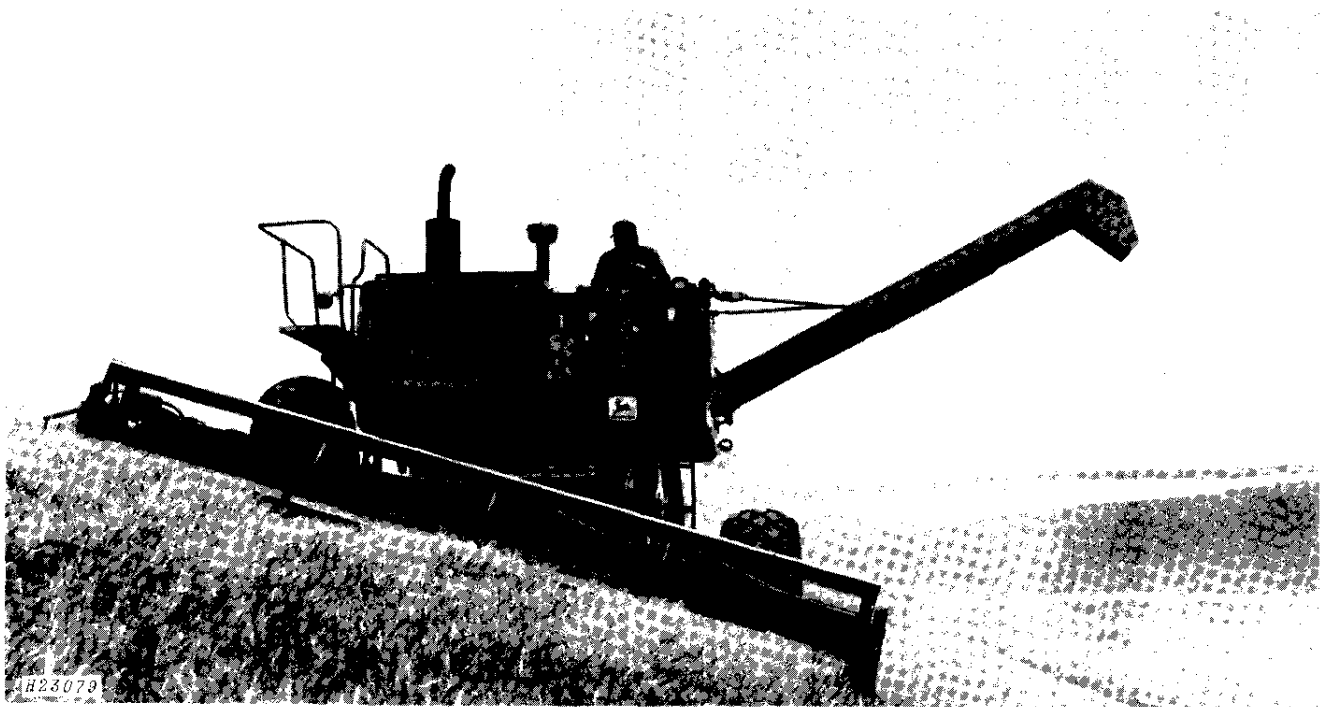



# Contents

	Page
Controls and instruments .....	2-3
Operation .....	4-35
Safety suggestions .....	36
Fuels and lubricants .....	37-38
Lubrication and periodic service .....	39-53
Service .....	54-119
Trouble shooting .....	120-136
Storage .....	137-139
Attachments .....	140-142
Specifications .....	143-146
Index .....	147

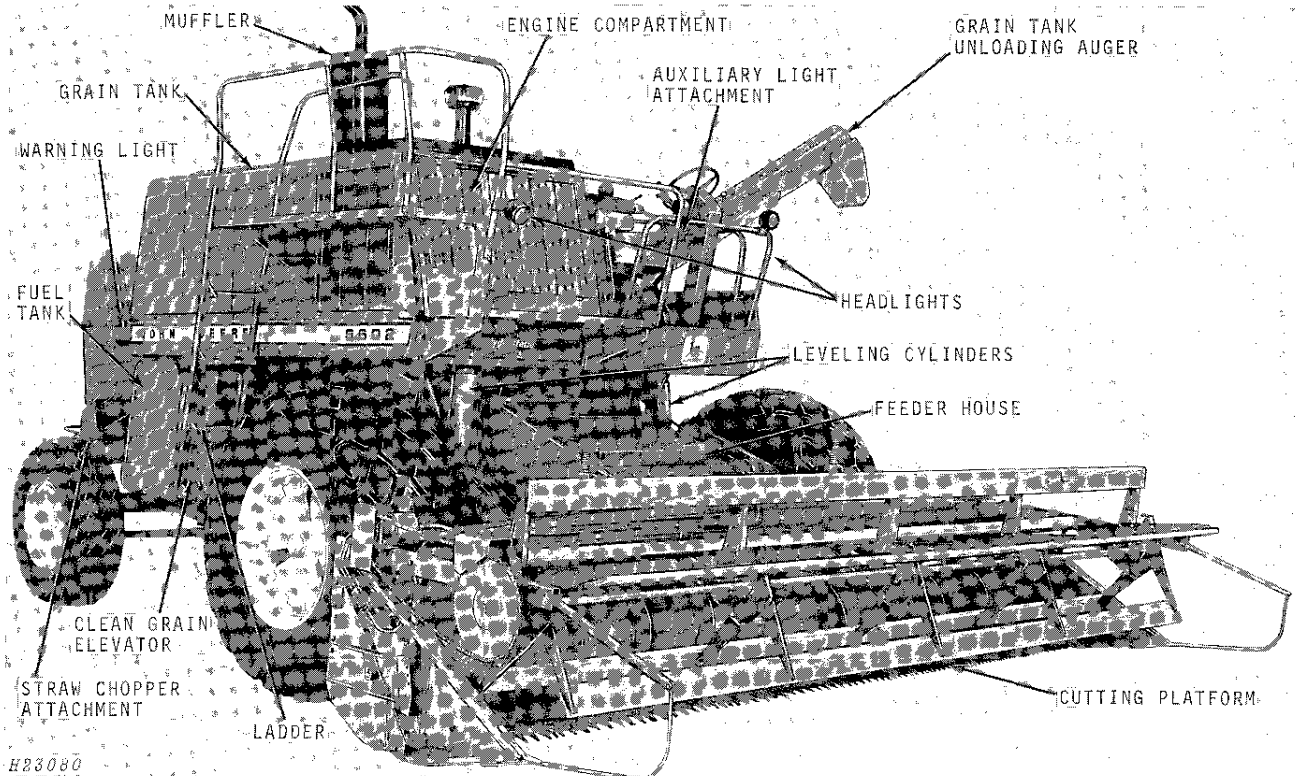

John Deere 6602 Combine

**<https://www.ebooklibonline.com>**

Hello dear friend!

Thank you very much for reading.

Enter the link into your browser.

The full manual is available for immediate download.

**<https://www.ebooklibonline.com>**



# Controls and Instruments

This section illustrates all controls and instruments necessary for successful field operation. For an explanation of each control and instrument, refer to the page reference given.

Before attempting to operate your new combine, become familiar with the location and purpose of its controls and instruments. Study these pages carefully, regardless of your previous combine experience.

The control levers and knobs have different colors and shapes. These have been designed to help you quickly locate the controls while operating the combine. Colors on controls indicate:

**RED**—Combine movement controls (Throttle, Gearshift Lever, Hydrostatic Speed Range Lever)

## OPERATOR'S PLATFORM

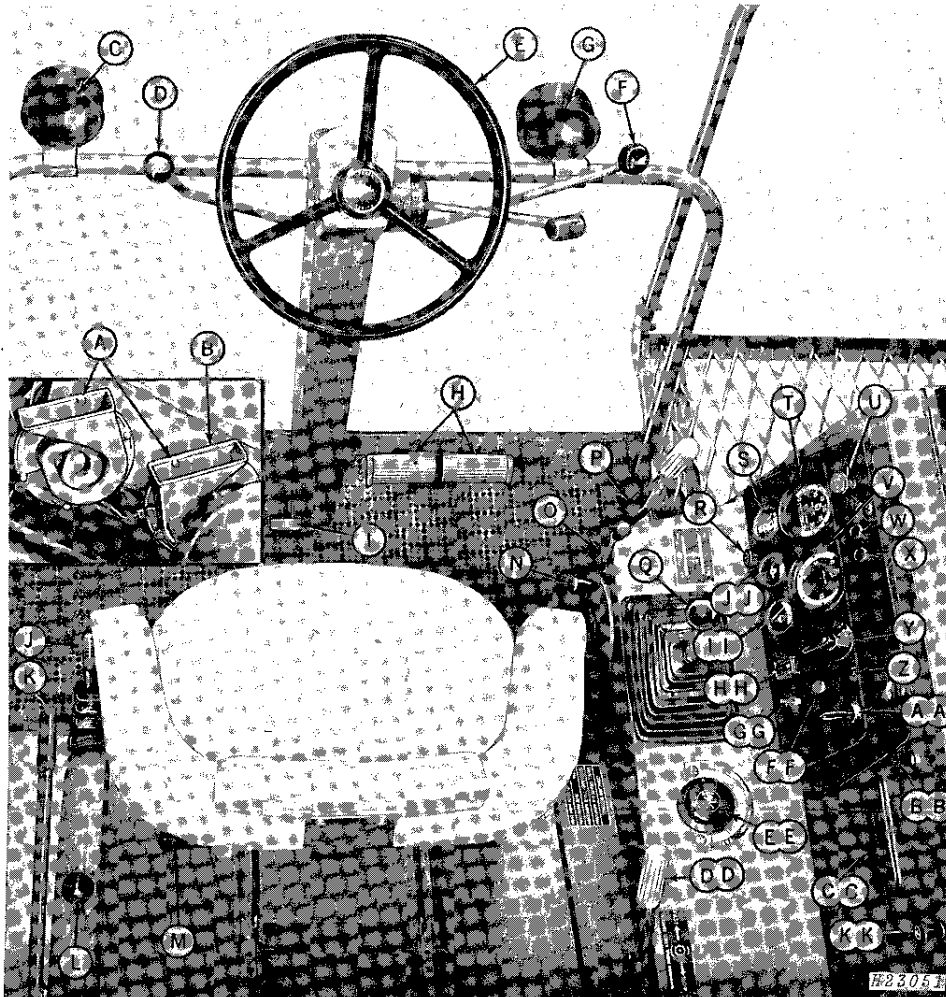

YELLOW—Auxiliary Power Controls (Separator Control Lever, Cylinder Speed Control Ratchet, Platform Electromagnetic Clutch Switch)

BLACK—Miscellaneous Function Controls (Platform Height Control, Hydraulic Lift Reel Control, etc.)

**ENGINE - AIR INTAKE**

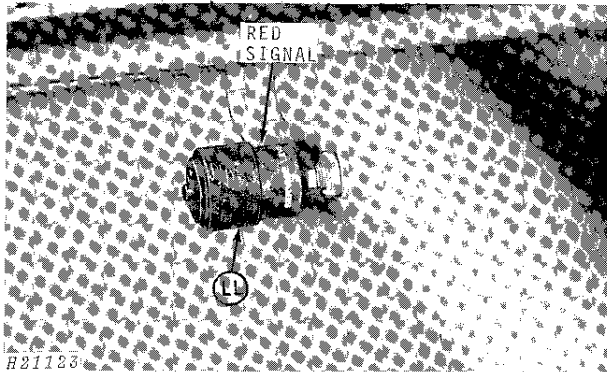

**SEPARATOR**

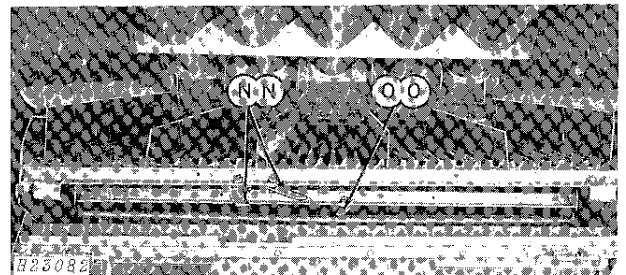
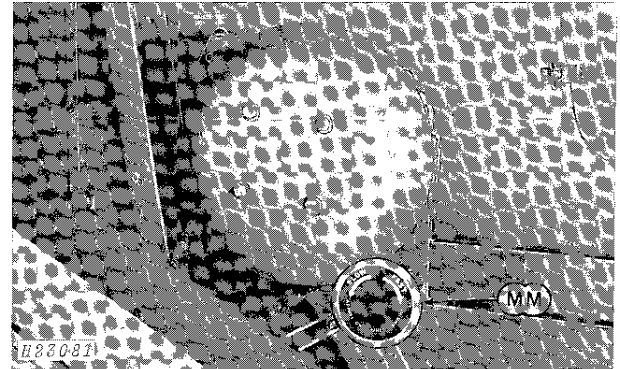

	Page
A - Truck Signal Horns .....	31
B - Coolant Temperature Warning Horn or Straw Walker Warning Horn (Attachment) .....	7-31
C - Headlight .....	31
D - Hydraulic Lift Reel Control Lever .....	14
E - Steering Wheel .....	25
F - Platform Height Control Lever .....	12
G - Hydrostatic Drive Speed Range Control Lever .....	25
H - Brake Pedals .....	26
I - Steering Column Control .....	10
J - Parking Brake Lever .....	25
K - Grain Tank Unloading Auger Lever .....	24
L - Unloading Auger Swing Control .....	24
M - Operator's Seat Control .....	9
N - Concave Opening Control Wheel .....	19
O - Throttle .....	6
P - Separator Control Lever .....	18
Q - Gearshift Lever .....	25
R - Choke (Gasoline Engine Only) .....	6
S - Fuel Gauge .....	7

	Page
T - Engine Tach-Hour Meter .....	7
U - Platform Electromagnetic Clutch Switch .....	12
V - Cylinder Speed Tachometer .....	18
W - Parking Brake Indicator Light .....	25
X - Alternator Indicator Light .....	6
Y - Light Switch .....	31
Z - Horn Button .....	31
AA - Key Switch .....	6
BB - Cigarette Lighter .....	31
CC - Ash Tray .....	31
DD - Cylinder Speed Control Ratchet .....	18
EE - Hydrostatic Drive Reel Control .....	13
FF - Limit Leveling Warning Light .....	29
GG - Leveling Control Cut-Out Switch .....	29
HH - Manual Leveling Control Switch .....	29
II - Coolant Temperature Gauge .....	7
JJ - Engine Oil Pressure Gauge .....	7
KK - Fuel Cut-Off Switch (Diesel) .....	6
LL - Air Restriction Indicator .....	7
MM - Fan Speed Control Wheel .....	22
NN - Chaffer Opening Controls .....	22
OO - Sieve Opening Control .....	22



# Operation

---

## COMBINE AND ENGINE BREAK-IN

Follow the lubrication instructions closely. See pages 39 to 53.

Check coolant level in radiator and add coolant if necessary. Do not use water containing alkali. If combine is being operated in temperatures below 32°F., refer to "Cold Weather Operation," page 5.

To promote good ring seating and to prevent cylinder wall glazing, put the engine to work as soon as possible. Do not overload.

### AFTER 1 HOUR

Check torque on drive wheel lug bolts. Tighten bolts to 150-185 ft-lbs torque.

### AFTER 5 HOURS

Check all V-belts for initial stretch. Tighten if necessary. Continue to check V-belts every few hours for the first 50 hours.

### AFTER 20 HOURS

Drain oil from main hydraulic unit reservoir. Replace the oil filter and fill the reservoir with oil as specified on page 38. Thereafter, drain and replace oil and oil filter element every 500 hours of operation.

Replace the leveling hydraulic oil filter, as shown on page 53. Operate the leveling system for a short time and fill the hydrostatic drive and leveling oil reservoir (page 52) with oil as described on page 38.

### AFTER 100 HOURS

During break-in, if oil consumption warrants, add oil as specified on page 37.

After the first 100 hours of operation, drain oil from crankcase, replace oil filter, and fill crankcase to proper level with John Deere Torq-Gard or Torq-Gard Supreme engine oil or its equivalent as specified in lubricants chart on page 37.

Thereafter change the oil and filter every 100 hours of operation or every season, whichever occurs first.

## COLD WEATHER OPERATION

### FUEL SYSTEM

Use winter-grade fuel. Fill the fuel tank at the end of the day's run to prevent moisture from condensing in the fuel tank.

### COOLING SYSTEM

Drain, flush, and fill cooling system with a recognized brand of radiator sealer and antifreeze solution. Use a permanent-type (ethylene glycol) antifreeze solution containing rust inhibitors. This type of antifreeze is resistant to evaporation when heated. Do not use antifreeze which contains stopleak additives.

#### QUARTS OF ETHYLENE GLYCOL REQUIRED AT LOWEST EXPECTED TEMPERATURE

+20°F	+10°F	0°F	-10°F	-20°F	-34°F
5-1/4	8	10-1/2	12-1/2	14	16

After filling, check system for leaks.

### AUTOMATIC LEVELING SYSTEM

Fill the fluid container, located on the lower left-hand side of the separator, with 50 percent water and 50 percent permanent-type (ethylene-glycol) antifreeze solution.

### BATTERIES

When the temperature drops below freezing, be sure batteries are fully charged. A badly discharged battery freezes more quickly than one that is well charged. For example, a battery with a specific gravity reading of 1.175 (discharged) will freeze at 4°F., and a battery with specific gravity reading 1.300 (fully charged) will not freeze until the temperature reaches -65°F.

In freezing weather, do not add water to the batteries unless engine is going to be run. Water will freeze as it will not mix with the electrolyte until the alternator passes a charging current through the batteries.

**IMPORTANT:** If booster batteries are required, see instructions on page 100.

### COLD WEATHER STARTING AID

Diesel engines are equipped with an ether starting fluid adapter which injects atomized fluid into the engine air intake system. Normally ether is used for starting at temperatures below 32°F. Pressurized cans of starting fluid are available from your John Deere dealer.

To use the starting fluid, remove the safety cap and plastic spray button from the can. Remove the cap from the adapter and position the can under the adapter.

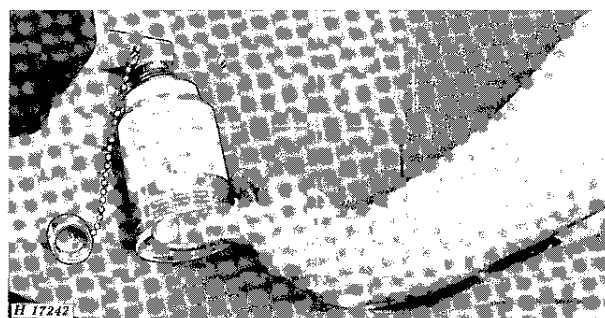

**IMPORTANT:** To avoid damage, turn engine with starter one or two revolutions before injecting starting fluid. Inject starting fluid only while the engine is turning.

To inject starting fluid, push up on the can.

Relax pressure on the can between "shots" of starting fluid. Stop injecting fluid after the engine starts. If the engine begins to die during the first few minutes of operation, inject another "shot" of fluid. When the engine is operating satisfactorily, remove the can from the adapter and replace the safety cap on the can.

Install the cap on the adapter when it is not in use to prevent dust from being drawn into the engine.

**CAUTION:** Ether starting fluid is highly flammable. Store starting fluid cans where they will not be subject to extreme cold or warm temperatures. For best results, store fluid at room temperature.

## HOT WEATHER OPERATION

Protect the combine engine cooling system against corrosive action by using Summer Engine Coolant Conditioner.

The Summer Engine Coolant Conditioner is available under Part No. T19566, and may be purchased from your John Deere dealer.

To install the Summer Engine Coolant Conditioner, perform the following:

Drain and flush cooling system and add two 32-oz. cans of Summer Engine Coolant Conditioner to the cooling system following directions on the container.

**IMPORTANT: Summer Engine Coolant Conditioner is NOT AN ANTIFREEZE or a cooling system sealer. Drain system and fill with recommended antifreeze solution as required for winter protection. When antifreeze solution is in system, it should not be necessary to use the Conditioner; however, should severely corrosive water conditions be present, the Conditioner is compatible with antifreeze solutions.**

## OPERATING THE ENGINE

### ENGINE INSTRUMENTS AND CONTROLS

#### Choke (Gasoline Engine Only)



X 2228

Pull choke control all the way out when starting engine. After engine is started, and for normal operation, push choke control all the way in.

#### Fuel Shut-Off Switch (Diesel Engines Only)

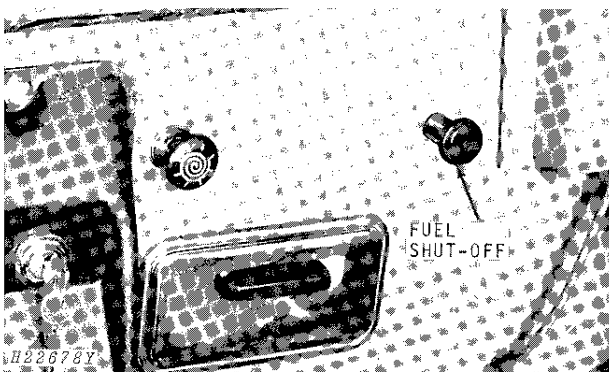

The fuel shut-off switch cuts off the fuel supply to the fuel injection pump. Push the knob all the way in before attempting to start engine.

To stop engine, turn key to off position and pull fuel shut-off knob all the way out until engine stops running.

Release the key when the engine starts. The alternator indicator light should go out.

If the light does not go out after 10 seconds, shut off engine at once and determine the cause.

If the engine fails to start, refer to the trouble shooting charts on page 131.

#### Alternator Indicator Light

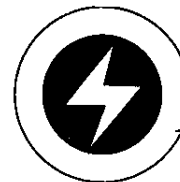

GLOWS RED IF ALTERNATOR IS NOT CHARGING

X 2229

This light glows red when the alternator is not charging. If the light goes on while the engine is running, stop engine and determine cause.

Check the operation of this light by turning the key to the "ON" position.

### Coolant Temperature Gauge

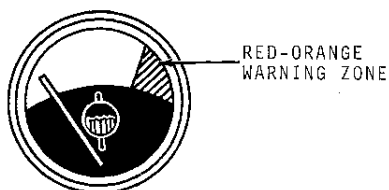

X 2231

This gauge indicates the coolant temperature in the cooling system—not the quantity. The white zone on the dial indicates normal operating temperature; the red-orange zone indicates above normal operating temperature.

If the pointer on the gauge goes into the red-orange zone, stop the engine and determine the cause.

### Coolant Temperature Warning Horn

The low note horn sounds when the coolant temperature gauge registers "HOT." When the straw walker sensing unit (attachment) is activated, the horn will also sound.

If the horn sounds, stop engine and check the straw walkers for plugging and the engine for overheating.

If the straw walkers are not plugged, determine the cause of engine overheating.

### Air Restriction Indicator

The red signal in the restriction indicator is locked in view whenever the air cleaner element is dirty and needs servicing. Check the indicator every 10 hours and service the element (page 117) if necessary.

### Engine Oil Pressure Gauge

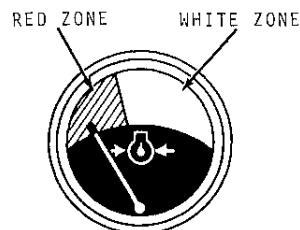

X 2232

This gauge indicates the pressure of the engine lubricating oil—not the amount of oil in the crankcase. Oil pressure will vary slightly with wear, but with recommended oil, it should read NORMAL at full governed speed (indicated by white zone on the dial). If oil pressure drops (indicated by red zone on the dial), stop immediately and determine the cause.

### Fuel Gauge



X 2233

The red-orange zone indicates that the tank is empty. A half-full mark and a full mark indicates the fuel level in the tank.

### Engine Tach-Hour Meter

The Tach-Hour meter shows the engine speed in hundreds of rpm and accumulated engine service in hours and tenths of hours (based on an average engine operating speed of 2300 rpm). Use this hour meter to determine when lubrication and periodic services are needed.

## STARTING THE GASOLINE ENGINE

1. If starting in cold weather, see "Cold Weather Operation," page 5.
2. Disengage platform electromagnetic clutch switch, separator control lever, and grain tank unloading auger lever.
3. Place gearshift lever in neutral.
4. Place the hydrostatic speed range lever in neutral.
5. Move throttle lever one-quarter open.
6. Pull the choke control out.
7. Turn key to "ON." Check the operation of the alternator indicator light. It should glow red.
8. Turn key to "START."

After engine starts, release key and push the choke control in.

**IMPORTANT: When starting the engine, never hold the key in start position for more than 30 seconds at a time. If the engine does not start within 30 seconds, allow at least 2 minutes for proper cooling of the starter. Be sure to pause a few seconds after a false start to make certain that the starter has stopped completely before another start is attempted.**

If engine fails to start, see TROUBLE SHOOTING, page 131.

9. Make certain the oil pressure gauge registers pressure and the alternator indicator light goes off. If not, stop engine and determine the cause.

10. Warm the engine and transmission for 5 minutes at fast idle—no load.

**IMPORTANT: Do NOT tow hydrostatic drive combines to start engine.**

## STOPPING THE GASOLINE ENGINE

Set the throttle at medium idle speed and allow the engine to run at this speed for a few minutes before stopping.

Turn key to "OFF."

After stopping the engine, remove the key from the switch to prevent tampering and unauthorized operation. Removing the key also prevents the switch from being accidentally left in the "on" or the "accessory" position and causing battery discharge.

## STARTING THE DIESEL ENGINE

1. If the engine has not been operated for a long period of time, or if the fuel tank has run dry, bleed the entire fuel system to remove air bubbles. See pages 107 and 108.

**IMPORTANT: Never let the fuel tank run dry.**

2. If starting in cold weather, see "Cold Weather Operation," page 5.
3. Disengage platform electromagnetic clutch switch, separator control lever, and grain tank unloading auger lever.
4. Place gearshift lever in neutral.
5. Place the hydrostatic speed range lever in neutral.
6. Move throttle lever one-quarter open.
7. Make sure the fuel shut-off knob is all the way in.
8. Turn key to "ON." Check the operation of the alternator indicator light. It should glow red.
9. Turn key to "START."

After engine starts, release key.

**IMPORTANT: When starting the engine, never hold the key in start position for more than 30 seconds at a time. If the engine does not start within 30 seconds, allow at least 2 minutes for proper cooling of the starter. Be sure to pause a few seconds after a false start to make certain that the starter has stopped completely before another start is attempted.**

If engine fails to start, see TROUBLE SHOOTING, page 131.

10. Make certain the oil pressure gauge registers pressure and the alternator indicator light goes off. If not, stop engine and determine the cause.

11. Warm the engine and transmission for 5 minutes at fast idle—no load.

**IMPORTANT: Do NOT tow hydrostatic drive combines to start engine.**

## STOPPING THE DIESEL ENGINE

Set the throttle at medium idle speed and allow the engine to run at this speed until the temperature gauge drops well into the white range on dial. Move the throttle to the rear, pull fuel shut-off knob out, and turn key to "OFF."

**IMPORTANT: Do not attempt to stop engine by turning off fuel supply at tank. Doing so will cause injection pump to run dry and damage internal parts.**

After stopping the engine, remove the key from the switch to prevent tampering and unauthorized operation. Removing the key also prevents the switch from being accidentally left in the "on" or the "accessory" position and causing battery discharge.

## OPERATOR'S PLATFORM COMPONENTS

### OPERATOR'S SEAT

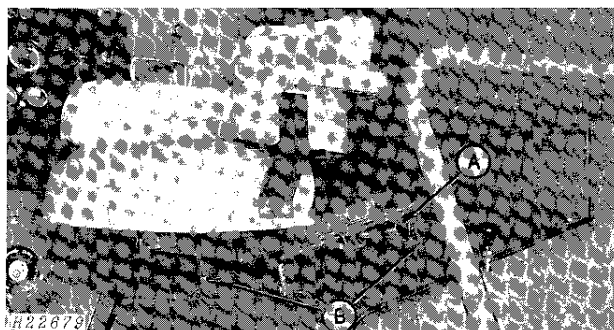

*Seat in Sitting Position*

The operator's seat moves forward and rearward or up and down to accommodate individual height and allow greater accessibility to all controls. If the operator wishes to stand, the seat can be positioned out of the way to allow ample leg space.

Use only warm water and mild soap to clean the seat cushions. NEVER USE SOLVENTS.

#### **Positioning the Seat Forward or Rearward**

While sitting in the seat, push lever "A" forward as far as possible and, by using your weight, adjust seat to desired position. Then release lever "A."

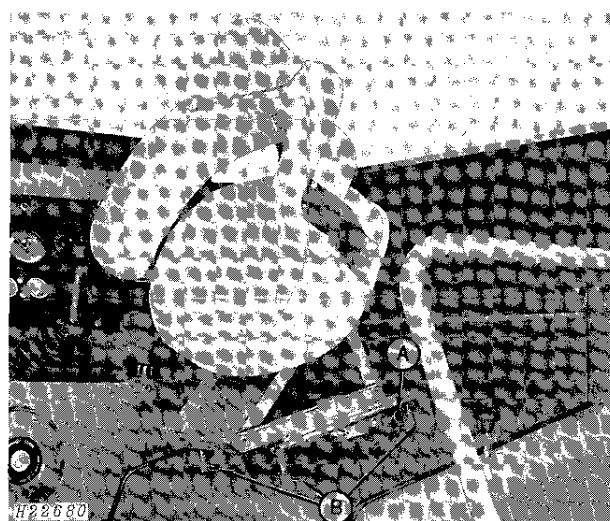

*Seat in Standing Position*

#### **Positioning the Seat Up or Down**

Remove four spring locking pins "B." Raise or lower the seat to the desired height. Reinsert spring locking pins "B."

#### **Positioning the Seat for Standing**

To move the seat up and back, stand up and apply pressure to the front of the seat with the back of your legs. The seat will move to the up and back position to allow standing room.

To return the seat to the sitting position, move the seat forward by pulling on the front of the seat with your hand.

### STEERING COLUMN

The steering column is adjustable to one of four positions for individual arm lengths. This allows better visibility and greater accessibility to the steering wheel and controls on the steering column.

#### Steering Column Control

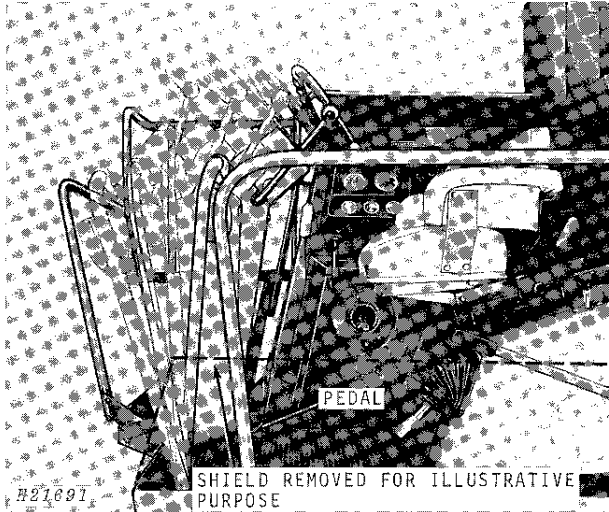

To adjust steering column, push pedal down, position column to desired setting, and release pedal.



### LADDER AND CATWALK

A pull-down ladder and catwalk provide easy access to the operator's platform.

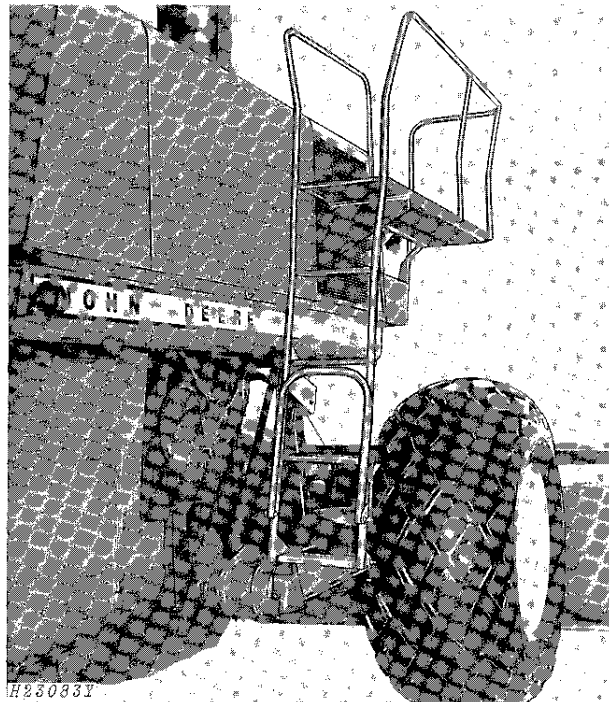

Storage Position

Pivot the lower section of the ladder down for access to the operator's platform.

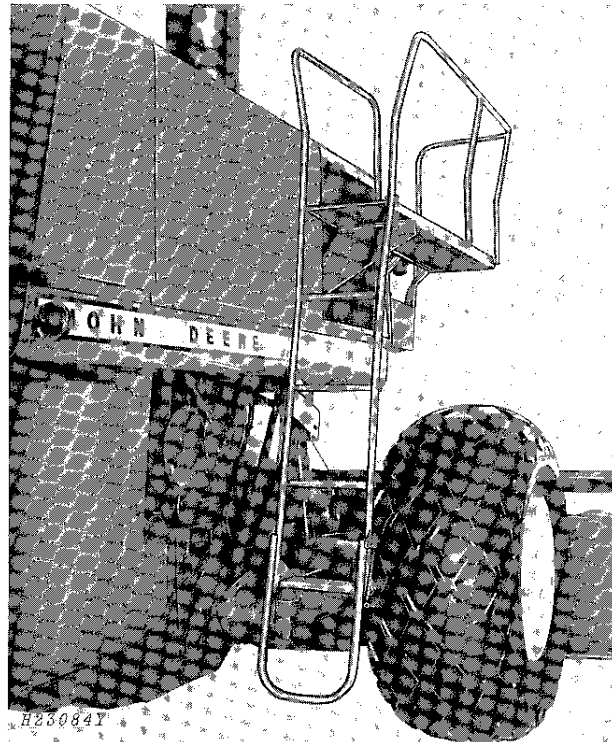

Access Position

Pivot the lower section of the ladder up for storage position.

Do not operate the combine unless the ladder is in storage position.

## TRANSPORTING

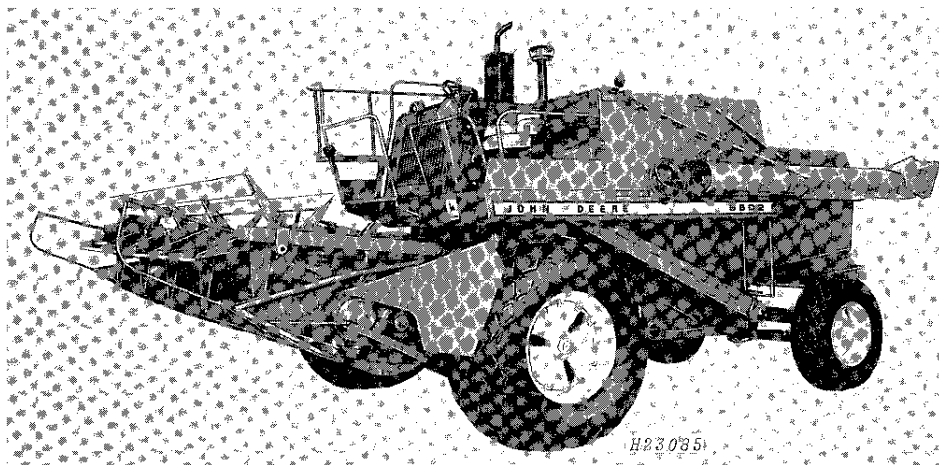

The combine can be transported by driving it under its own power, carrying it on a truck, or by towing it.

Reduce the width of the combine by folding the unloading auger back along the separator and removing the platform. Over-all dimensions are given on page 145.

When unloading auger is folded back along the separator, the unloading auger spout must be raised so as not to block the left-hand warning light from view of vehicles approaching from the rear.

If the platform and feeder house are removed, the hydraulic cylinders must be wired or supported by chains no closer to separator support than 14 inches. Damage may result to hoses if carried too close.

If the platform is left on, raise it to a position allowing good visibility.

If combine is to be transported long distances, rotate lock plate in leveling control switch box to hold switch lever in its mid position and close the needle valve. See page 94. Also disengage the leveling mechanism by placing the leveling control cut-out switch in the "OFF" position (page 29).

Reduce the spread of noxious weed seeds by thoroughly cleaning the combine before leaving one field and going to the next.

Sweep trash and straw from the outside of combine. Open doors at bottom of elevators, remove grain tank drain hole cover, and run combine until all straw, trash, and grain are removed from inside. Shut off combine engine. Clean out shoe grain supply augers (page 78).

**CAUTION:** When driving the combine on a road or highway at night or during the day, use accessory lights and devices provided for adequate warning to the operators of other vehicles. In this regard, check local governmental regulations.

The combine is equipped with headlights, taillight, flashing warning lights, grain tank reflectors, and slow moving vehicle emblem on the rear hood. Keep the lights, reflectors, and emblem clean.

If flashing lights are prohibited by local regulations, reconnect wires so lights will not flash. See wiring diagram on page 105.

If the combine is to be transported on a truck, remove brake lines from final drives and remove the main drive wheel and final drive assemblies from combine to reduce width.

If the combine is to be towed, place the gearshift lever in its "tow" position and the hydrostatic drive speed range lever in neutral. Telescoping drive shafts need not be disconnected or brake adjusting nut backed off if towed at speeds less than 16 mph.

Make certain to reinstall telescoping drive shafts and readjust wheel brake adjusting nuts before operating combine under its own power.

**CAUTION:** Brake system must be free of air before towing the combine or transporting under its own power. See page 91 for bleeding the brake hydraulic system.

## FIELD AND CROP OPERATING ADJUSTMENTS

This section explains adjustments which are made due to crop or field conditions. Adjustments which are made to compensate for wear or misalignment are explained in the SERVICE section, page 54. For illustrations of controls not shown in this section, see the CONTROLS AND INSTRUMENTS section, page 2.

### PLATFORM

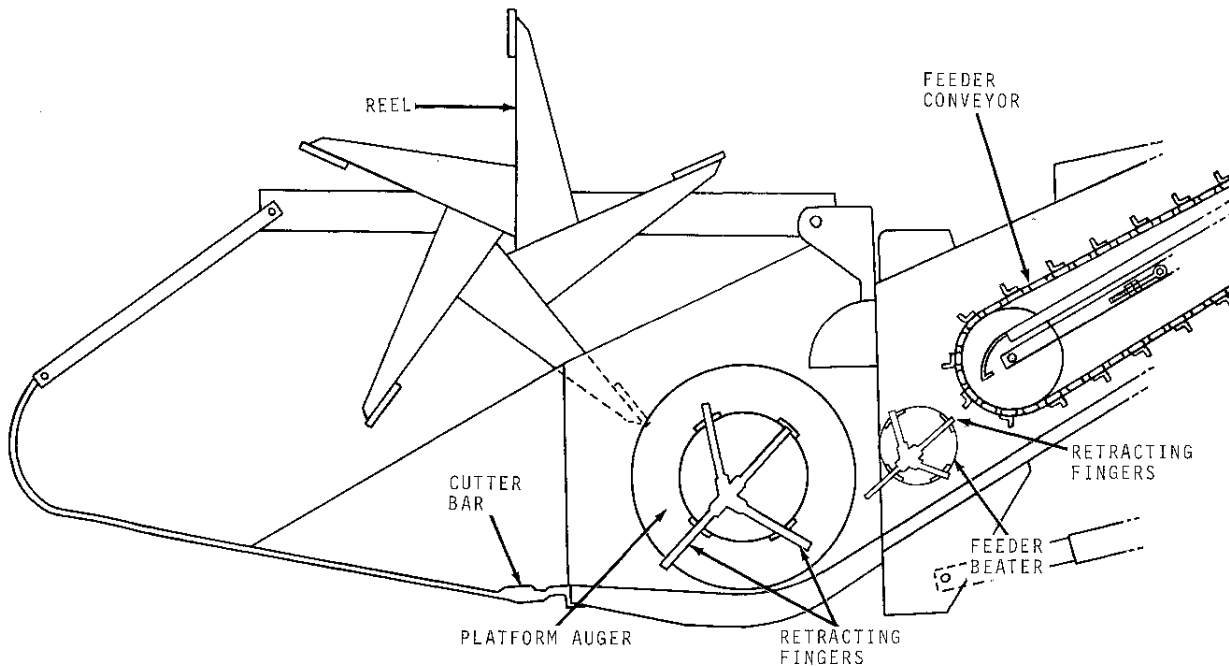

H23086

The platform receives the crop and moves it to the front of the feeder house by means of an auger. Retracting fingers in the auger feed the material to the feeder beater and the feeder conveyor.

Height of the platform can be changed by moving the platform height control lever located on the steering column. As a safety measure, platform height cannot be changed unless the engine is running.

The platform electromagnetic clutch is either engaged or disengaged by operating a switch on the instrument panel.

Platform performance depends largely on maintaining correct unit speeds (page 32) and keeping the platform parallel to the ground.

While servicing the platform, always use the hydraulic cylinder safety stops (page 58).

### Platform Electromagnetic Clutch Switch

Push switch in to disengage clutch. Pull switch out to engage clutch.

### Platform Height Control Lever

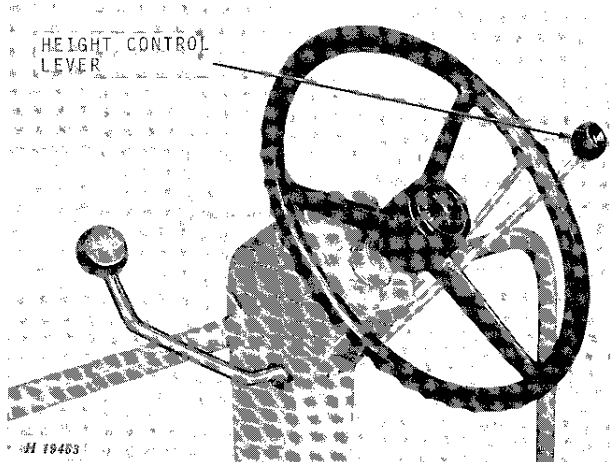

To lower the platform, move the height control lever forward.

To raise the platform, move the lever rearward.

The lever automatically returns to the neutral position when released.

Regulate the speed of platform lowering by turning a cap screw on the control valve (page 96).

## Reel

Reel slats gather the crop, hold it until it is cut by the knife, and then move it into the platform auger. Keep the reel level, at proper height, and at proper speed to feed the cut material uniformly and steadily to the platform auger.

Set reel so the slats, in their lowest position, strike just below the lowest grain heads and slightly ahead of the knife.

In crops that are down and badly tangled, set the reel so it will just clear the knife and platform auger. In this position, the material is swept back into the platform auger.

Keep the speed of the reel as fast as possible without shattering the grain or carrying the straw around over the top of the reel. The speed of the reel should be approximately 1-1/4 times the ground travel speed.

### Reel Speed Control Knob

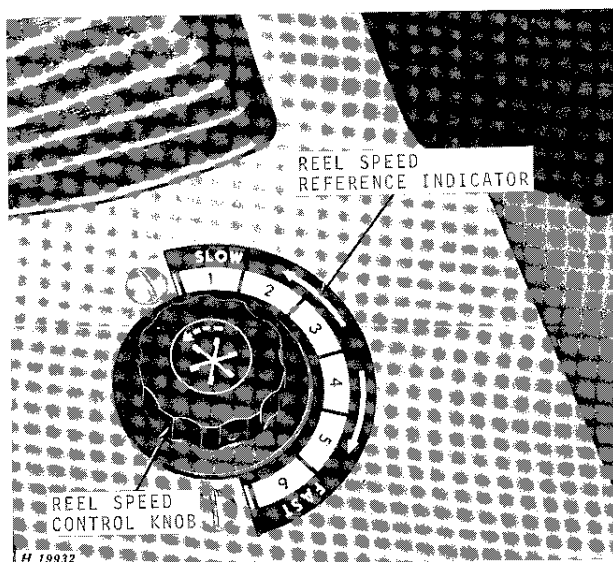

Reel speed is adjusted by turning the control knob located on the instrument console. The reel speed can be changed from 5 rpm to 40 rpm on the pickup reel and from 8 rpm to 64 rpm on the slat reel.

To increase the reel speed, turn the knob toward FAST. To decrease the reel speed, turn the knob toward SLOW.

Use the reference indicator as a guide to return to the reel speed that was previously found best for a particular crop or field condition.

### Forward or Rearward Adjustment

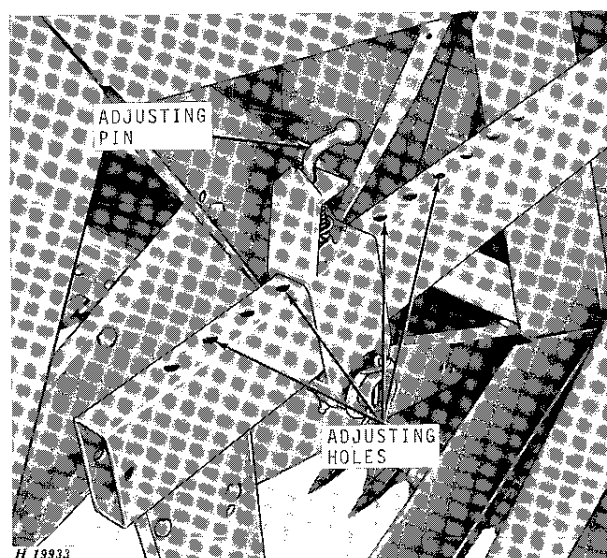

A series of holes is provided on the reel support arms so the reel can be moved forward or rearward. Lift up the adjusting pin, move the reel to desired position, and install adjusting pin. Be certain to adjust both sides evenly.

Check drive chain tension and adjust (page 62) when moving reel forward or rearward.

### Height Adjustment

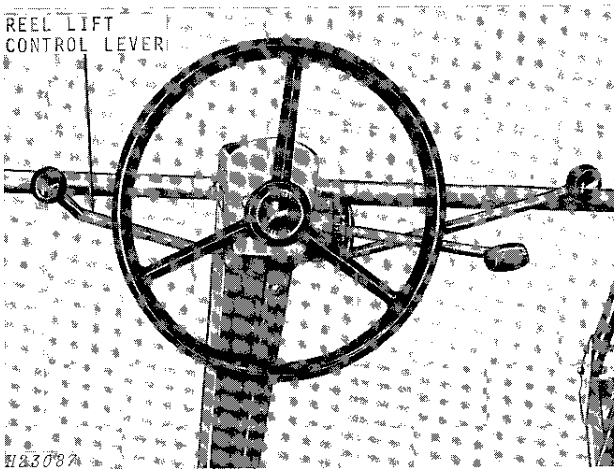

Height of the reel is controlled by a lever on the left-hand side of the steering column.

To raise the reel, move the lever rearward. To lower the reel, move the lever forward. The lever automatically returns to neutral when released.

Regulate the speed of reel lowering by turning a nut on the control valve (page 96).

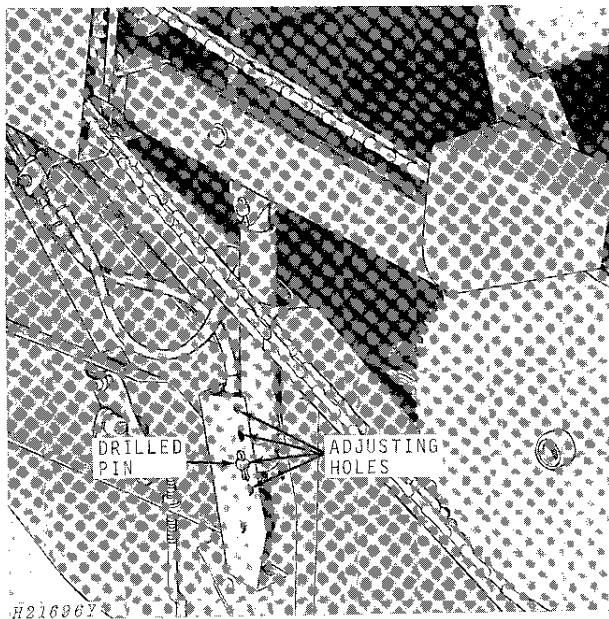

The height range of the reel is determined by the location of the bottom of the hydraulic cylinders in the adjusting brackets. Only the top four holes are the adjusting holes in the right hand bracket.

**CAUTION:** The reel arm is heavy and must be supported when removing pin.

Remove the drilled pin, move hydraulic cylinder to desired position and install drilled pin. Adjust both hydraulic cylinders alike or the reel will not be level with the cutter bar.

**IMPORTANT:** When the hydraulic cylinders are completely retracted, be certain that the reel slats or pickup reel fingers do not strike the cutter bar.

### Leveling

Always keep the reel level with the cutter bar. Be sure both hydraulic cylinders are located in the same hole in each adjusting bracket as explained above.

If, during operation, one end of the reel is lower than the other, raise the reel to its highest position or lower the reel to its lowest position. When both hydraulic cylinders are completely extended or retracted, the reel can then be returned to its original position and it will automatically be level.

If the reel cannot be leveled by extending or retracting the hydraulic cylinders as explained above, air may be trapped in the system. To bleed air from the hydraulic system at the slave cylinder, see page 61.

### Cutter Bar

The cutter bar is basically a multiple series of shears. To cut properly, the knife must run smoothly in the cutter bar, and every knife section must rest on the guard in the position to make a shear cut. This means that the guards (page 59), wearing plates (page 60), and knife clips (page 59) must be in good condition and set correctly. If these parts become loose or worn, the knife will chew and tear the crop instead of cutting it.

Do not run the cutter bar closer to the ground than necessary to cut all the crop. Keep the cutter bar aligned at all times (page 60).

### Cutter Bar Drive Gear Case

The cutter bar is driven by a case enclosed "wobble joint" drive. All moving parts are enclosed and operate in high-pressure lubricant (page 50).

Operate the cutter bar at a steady constant speed (page 32). Check and adjust drive belt tension as necessary (page 61).

### Platform Auger

A 1/8- to 5/8-inch clearance between the auger flights and platform bottom and between the auger flights and the auger stripper is required for most crops and conditions to get smooth even feeding.

If the auger is too high or does not have the same relationship at both ends, material will be carried around the auger and will not be fed properly to the feeder conveyor.

It may be necessary to raise the auger when combining coarse stemmed crops.

#### Adjusting Auger Height

On right-hand side of platform, loosen two nuts "A." To raise the auger, loosen nut "B" and tighten nut "C." To lower the auger, loosen nut "C" and tighten nut "B."

On the left-hand side, loosen nuts "A", "B", and "C." To raise the auger, loosen bolt "D" and tighten bolt "E." To lower the auger, loosen bolt "E" and tighten bolt "D." Tighten nuts "A", "B", and "C."

**IMPORTANT: Keep auger level; be certain there is ample clearance for the auger fingers and proper clearance between auger flights and stripper. Check drive chain tension.**

#### Adjusting Auger Forward and Rearward

On right-hand side of platform, loosen the two bolts "D" in the adjusting bracket. Move auger to the necessary position, and tighten nuts.

*NOTE: Be careful not to destroy finger height setting.*

On left-hand side, move the auger rearward by loosening nut "F" and tightening nut "G." Move the auger forward by loosening nut "G" and tightening nut "F."

#### Adjusting Finger Clearance

Retracting auger fingers are adjustable to obtain the best delivery to the feeder conveyor.

Maintain equal clearance between both the end finger bearings and the finger cranks, as illustrated. Loosen lock nuts "H" and "I" and move shaft in or out as necessary. Then secure shaft in position by tightening lock nuts "H" and "I."

#### Adjusting Finger Height

On the right-hand side of the platform, loosen the two nuts "J." To move the extended fingers down on the auger tube, pivot the top of bracket forward. Tighten nuts "J." Fingers must clear platform bottom 1/8 to 1/4 inch. To move fingers up, reverse the procedure.

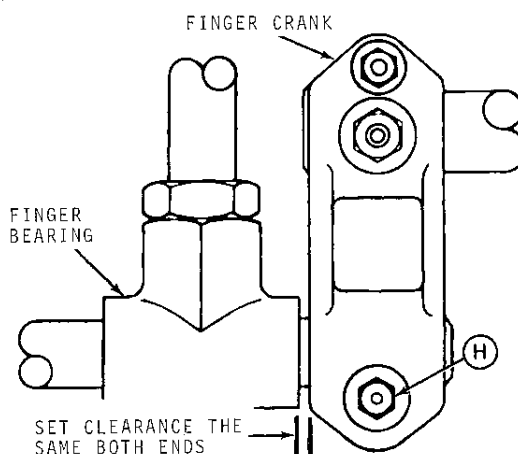
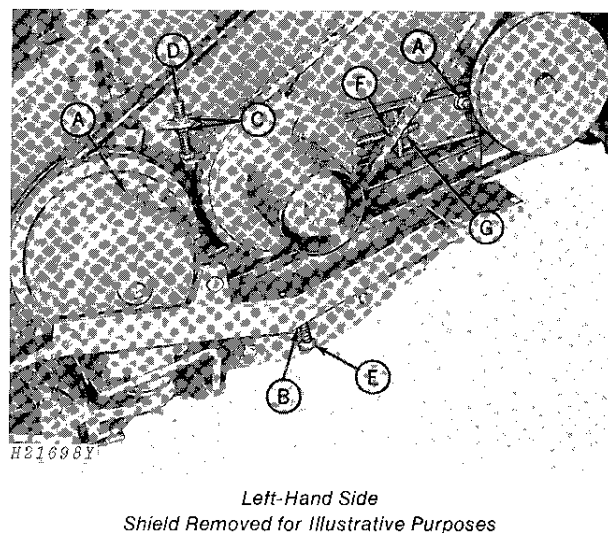
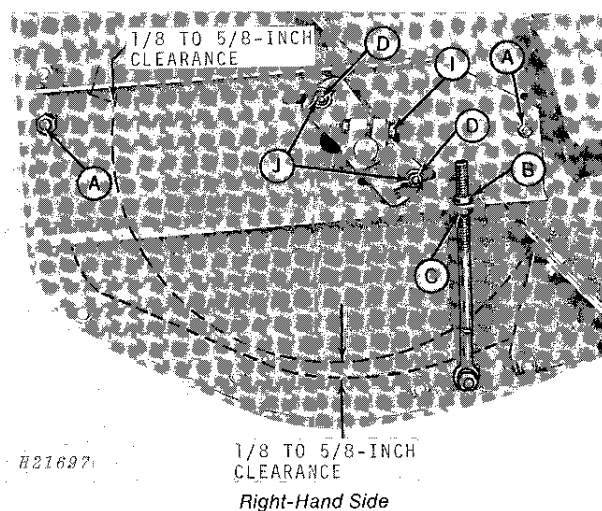

H21699

*NOTE: Be careful not to destroy the auger forward and rearward adjustment.*



**Suggest:**

**If the above button click is invalid.**

**Please download this document**

**first, and then click the above link**

**to download the complete manual.**

**Thank you so much for reading**

### FEEDER HOUSE

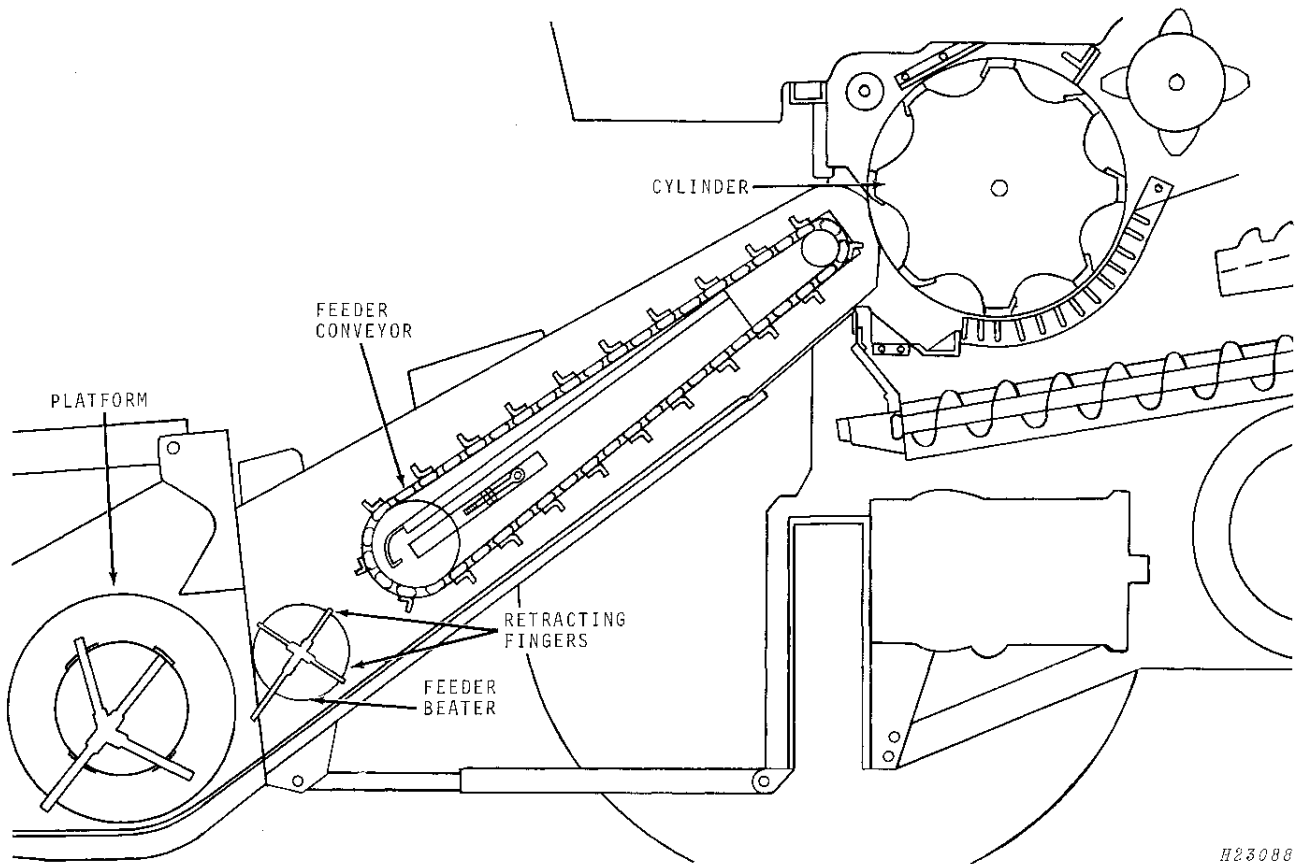

H23088

The feeder house receives the grain from the platform and force feeds it to the threshing cylinder.

The speed of the feeder house units must be as specified on page 32.

The speed of the feeder house determines the speed of the platform.

#### Feeder Beater

The feeder beater, at the front of the feeder house provides a positive pickup and delivery of grain from the platform auger to the feeder conveyor chain.

Adjust chain (page 64) so it will operate without climbing or jumping sprockets. Do not overtighten the chain.

#### Conveyor Chain

The feeder conveyor chain tension is checked by applying a pull of 15 to 20 lbs. along the outer edge of the roller chain, on both sides separately, below the rear half of the feeder conveyor top front door. See page 65.

With 15 to 20 lbs. pull, the chain should have a 1-1/4- to 1-3/4-inch deflection.

#### Conveyor Chain "Float"

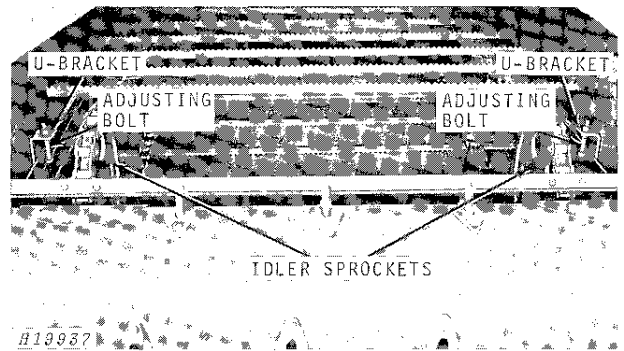

*Feeder Conveyor False Bottom Removed  
For Illustrative Purposes*

Two U-brackets, on either side of the feeder house, control the float of the idler sprockets. In normal field conditions, they provide sufficient float restriction.

If trash and dirt accumulate at the front of the conveyor chain and cause plugging, float adjusting bolts, provided with the combine, can be installed and adjusted to provide further float restriction. The conveyor chain will then wipe the feeder house bottom clean.

Access for adjusting bolts is through the feeder house bottom inspection door.

**<https://www.ebooklibonline.com>**

Hello dear friend!

Thank you very much for reading.

Enter the link into your browser.

The full manual is available for immediate download.

**<https://www.ebooklibonline.com>**