

# 6602 Combine



JOHN DEERE

## OPERATORS MANUAL

6602  
Combine

OMH101513 Issue A9 English

Harvester Works  
OMH101513 Issue A9

LITHO IN U.S.A.  
ENGLISH

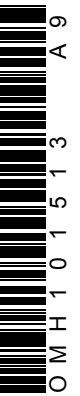



# To the Purchaser

---

This new combine was carefully designed and manufactured to give years of dependable service. To keep it running efficiently, read the instructions in this operator's manual. Each section is clearly identified so you can easily find the information you need—whether it is operation, lubrication, or service. Read the Table of Contents to learn where each section is located. Use the alphabetical index for fast reference.

**⚠** This safety alert symbol identifies important safety messages in this manual. When you see this symbol, be alert to the possibility of personal injury and carefully read the message that follows.

"Right-hand" and "left-hand" sides are determined by facing in the direction the combine will travel when in use. The radiator end of the engine is referred to as the "front," the flywheel end as the "rear."

Record your combine serial numbers in the space provided on page 180. Your dealer needs this information to give you prompt, efficient service when you order parts or attachments. If your combine requires replacement parts, go to your John Deere dealer

where you can obtain genuine John Deere parts—accept no substitutes.

## IMPORTANT WARRANTY INFORMATION

The warranty on this tractor appears on your copy of the purchase order which you should have received from your dealer when making your purchase. This warranty provides you the assurance that John Deere will back its products where defects appear within the warranty period. In some circumstances, John Deere also provides field improvements, often without charge to the customer, even if the product is out of warranty.

Warranty and field improvements are a part of John Deere's product support program for customers who operate and maintain their equipment as described in this manual. Should the equipment be abused, or modified to change its performance beyond the original factory specifications, the warranty will become void and field improvements may be denied. Setting fuel delivery above specifications or otherwise overpowering machines will result in such action.





# Contents

	Page
Safety suggestions . . . . .	1
Controls and instruments . . . . .	2, 3
Operation . . . . .	4-43
Fuels and lubricants . . . . .	44-45
Lubrication and periodic service . . . . .	46-62
Service . . . . .	63-141
Trouble shooting . . . . .	142-168
Storage . . . . .	169-172
Attachments . . . . .	173-175
Specifications . . . . .	176-180
Index . . . . .	181-185

## Safety Suggestions

**A** Safety of the operator was one of the prime considerations in the minds of John Deere engineers when this combine was designed. Shielding, simple adjustments, and other safety features were built into the combine wherever possible.

Modifications to the machine may impair the function and or safety and affect machine life.

All machinery should be operated only by responsible persons who have been properly instructed and delegated to do so.

No riders should be allowed on the operator's platform when combine is in operation.

Be certain shields and guards are in place and in good condition before starting in the field.

Failure to follow proper procedures when mounting a tire on a wheel or rim can produce an explosion which may result in serious bodily injury. DO NOT attempt to mount a tire unless you have the proper equipment and experience to perform the job safely. Have it done by your John Deere dealer or a qualified tire repair service.

Detailed tire mounting instructions, including necessary safety precautions, are contained in John Deere Fundamentals of Service (FOS) Manual 55, Tires and Tracks, which is available from your John Deere dealer.

Escaping fluid under pressure can have sufficient force to penetrate the skin, causing serious personal injury. Before disconnecting lines be certain to re-

lieve all pressure. Before applying pressure to system, be certain all connections are tight and that lines, pipes and hoses are not damaged. Fluid escaping from a very small hole can be almost invisible. Use a piece of cardboard or wood, rather than hands, to search for suspected leaks.

If injured by escaping fluid, see a doctor at once. Serious infection or reaction can develop if proper medical treatment is not given immediately.

Clothing worn by combine operator should be fairly tight and belted. Loose jackets, shirts, or sleeves should never be worn because of the danger of getting into moving parts.

When you are exposed to any noise which is objectionable or uncomfortable, it is recommended that you wear a suitable hearing protective device (such as ear muffs or plugs.)

Make certain everyone is clear of the combine before starting so they cannot be struck by moving parts or caught in a drive belt or chain.

Never clean, lubricate, or adjust the combine when it is running.

Be especially careful when operating on hillsides because combine may tip sideways if it strikes a hole, ditch, or other irregularity.

Never attempt to clear obstructions off the header unless the combine is stopped and the engine shut off.

Keep the operator's platform clean. Do not use it as a place to carry loose tools, lunch boxes, etc.

Maintain a fire extinguisher in an easily accessible location and be familiar with its correct use.

Before leaving combine unattended, lower the header to the ground or support it with either the hydraulic cylinder safety stop or with blocks.

**<https://www.ebooklibonline.com>**

Hello dear friend!

Thank you very much for reading.

Enter the link into your browser.

The full manual is available for immediate download.

**<https://www.ebooklibonline.com>**



# Controls and Instruments

Before attempting to operate your new combine, become familiar with the location and purpose of all controls and instruments. Study these pages carefully, regardless of your previous combine experience.

Control levers and knobs have different colors and shapes to help you quickly locate them while operating the combine. Colors on controls indicate:

RED—Combine movement controls (Throttle, Gearshift Lever, Selective Ground Speed Control)

YELLOW—Auxiliary Power Controls (Separator Control Lever, Cylinder Speed Control Ratchet, Header Electromagnetic Clutch Switch)

BLACK—Combine Function Controls (Header Height Control, Hydraulic Lift Reel Control, etc.)

## OPERATOR'S PLATFORM

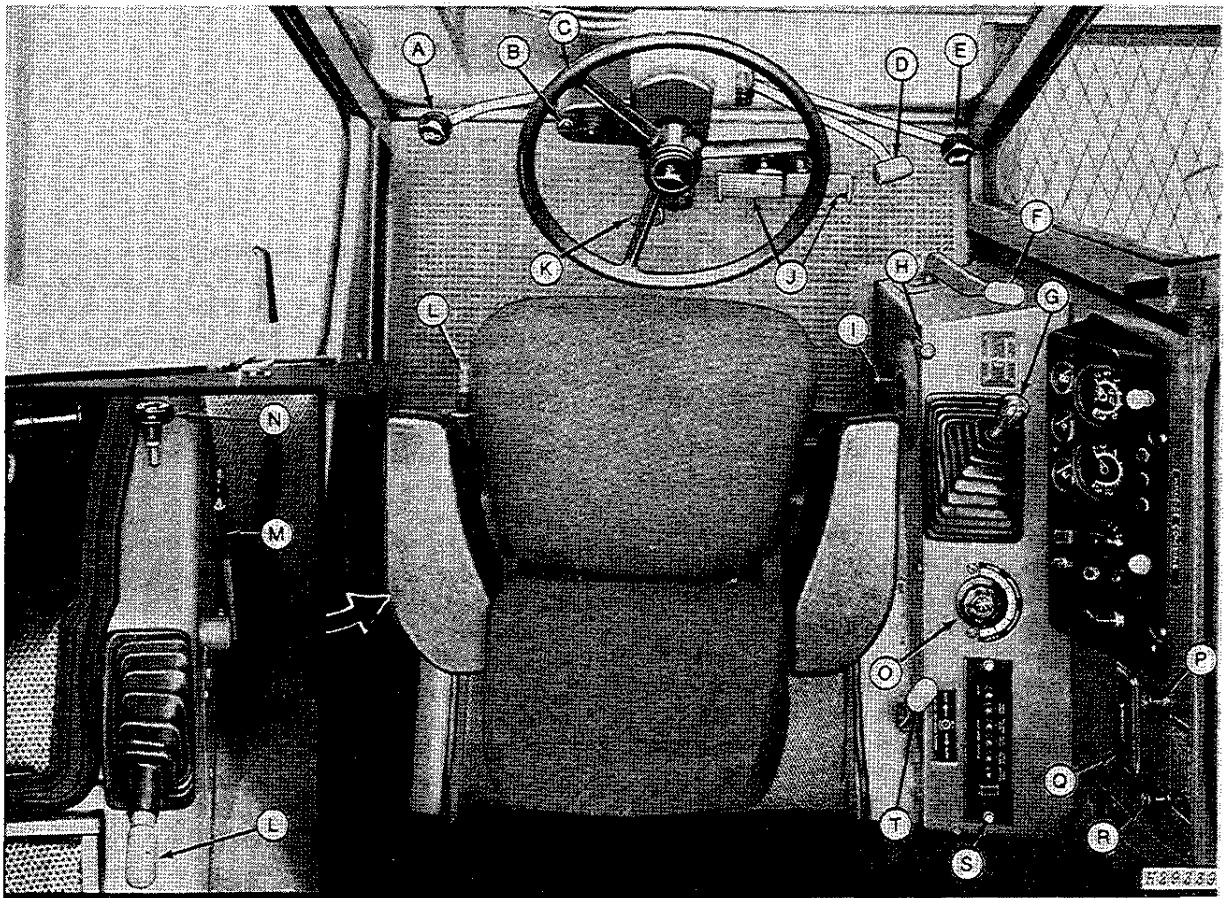

	Page
A—Hydraulic Lift Reel Control	16
B—Directional Turn Signals	15
C—Steering Wheel	—
D—Hydrostatic Drive Speed Range Control Lever	12
E—Header Lift Control	16
F—Separator Control	17
G—Gearshift	12

	Page
H—Throttle	4
I—Concave Opening Control	17
J—Brake Pedals	13
K—Steering Column Pedal	11
L—Parking Brake	12
M—Grain Tank Unloading Auger Lever	18

	Page
N—Unloading Auger Hydraulic Swing Control	18
O—Hydrostatic Drive Reel Control	16
P—Cigarette Lighter	—
Q—Ash Tray	—
R—Fuel Shut-Off	4
S—Low Shaft Speed Monitor (Opt.)	35
T—Cylinder Speed Control	17

### Instrument Panel Controls and Instruments

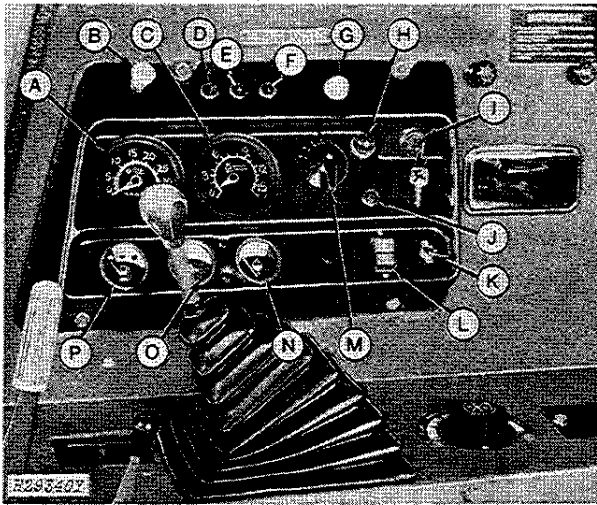

Page

A—Engine Tach-Hour Meter .....	5
B—Header Electromagnetic Clutch Switch .....	16
C—Cylinder Speed Tachometer .....	27
D—Parking Brake Indicator Light .....	12
E—Alternator Indicator Light .....	4
F—Transmission Oil Pressure Indicator Light .....	12
G—Cold Weather Starting Aid Button .....	7
H—Horn Button .....	--
I—Ignition Switch .....	4
J—Limit Leveling Warning Light .....	43
K—Leveling Control Cut Out Switch .....	43
L—Manual Leveling Control Switch .....	43
M—Light Switch .....	15
N—Coolant Temperature Gauge .....	4
O—Engine Oil Pressure Gauge .....	5
P—Fuel Gauge .....	5

### Operator's Cab Controls

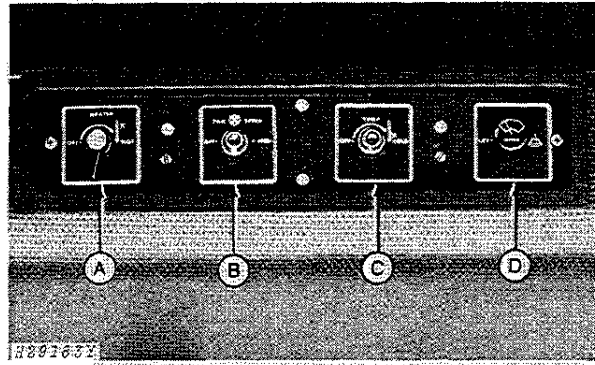

Page

A—Heater Temperature Control Switch .....	9
B—Pressurizer Fans Switch .....	9
C—Air Conditioner Temperature Control Switch .....	9
D—Windshield Wiper Switch .....	--

The operator's cab controls are located in the cab headliner. The radio is located in the rear right-hand corner of the cab.

*NOTE: For controls not located on the operator's platform (fan speed control, chaffer and sieve opening controls) see page 18.*



# Operation

## OPERATING THE ENGINE

### ENGINE INSTRUMENTS AND CONTROLS

#### Instrument Panel Controls and Instruments

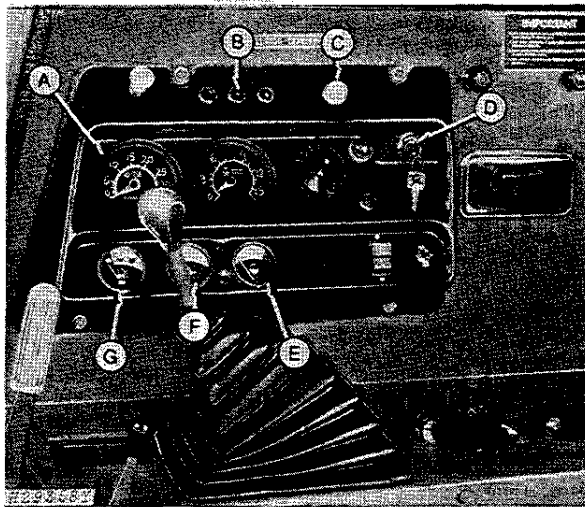

- |                                    |                             |
|------------------------------------|-----------------------------|
| A—Engine Tach-Hour Meter           | D—Ignition Switch           |
| B—Alternator Indicator Light       | E—Coolant Temperature Gauge |
| C—Cold Weather Starting Aid Button | F—Engine Oil Pressure Gauge |
|                                    | G—Fuel Gauge                |

#### Ignition Switch

Turn the key (D) clockwise to the first stop. Check that alternator indicator light glows red. If it does not, turn key off and see your John Deere Dealer.

Turn the key further clockwise and hold until engine starts. Release the key immediately when the engine starts. The alternator indicator light should go out. If it does not go out after 10 seconds, shut off engine at once and determine cause.

**IMPORTANT:** When starting the engine, never hold the key in start position for more than 30 seconds. If the engine does not start within 30 seconds, allow at least 2 minutes for proper cooling of the starter. Be certain to pause a few seconds after a false start to make certain that the starter has stopped completely.

If the engine fails to start, refer to the trouble shooting charts starting on page 152.

#### Throttle

Move throttle all the way forward for normal operation; move throttle all the way rearward for slow idle.

#### Fuel Shut-Off

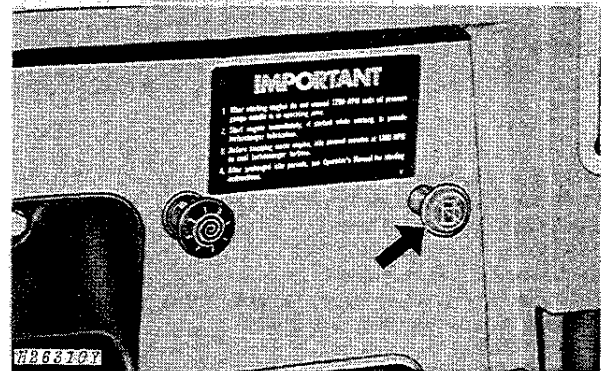

The fuel shut-off knob cuts off the fuel supply to the fuel injection pump. Push the knob all the way in before attempting to start engine.

To stop engine, turn key off and pull fuel shut-off knob all the way out until engine stops running.

#### Alternator Indicator Light

This light glows red when the alternator is not charging. If the light goes on while the engine is running, stop engine and determine cause.

Check the operation of this light by turning the key to the on position.

#### Coolant Temperature Gauge

This gauge indicates the coolant temperature in the cooling system—not the quantity. The white zone on the dial indicates normal operating temperature; the red-orange zone indicates above normal operating temperature.

If the needle on the gauge goes into the red-orange zone, stop the engine immediately and determine the cause.

## Coolant Temperature Warning Horn

A low note horn sounds when the coolant temperature gauge registers hot. This horn will also sound when the straw walker sensing unit (attachment) is activated.

If the horn sounds, stop engine and check the engine for overheating or straw walkers for plugging.

If the straw walkers are not plugged, determine the cause of engine overheating.

## Engine Oil Pressure Gauge

This gauge (F) indicates pressure of the engine lubricating oil. Oil pressure will vary slightly with wear, but with recommended oil, it should read normal at full governed speed (indicated by white zone on the dial). If oil pressure drops (indicated by red zone on the dial), stop engine immediately and determine cause.

## Fuel Gauge

A full mark, a half-full mark, and an empty mark indicates fuel level. The red-orange zone indicates that the fuel tank is empty.

## Engine Tach-Hour Meter

The tach-hour meter shows the engine speed in hundreds of rpm and accumulated engine service in hours and tenths of hours (based on an average engine operating speed of 2200 rpm). The green zone on the tachometer indicates correct engine operating range. Use this hour meter to determine when lubrication and periodic services are needed.

### PRESTARTING CHECKS

1. Check engine crankcase oil level (Page 50).
2. Check radiator coolant level (Page 132).
3. Check fuel tank level.
4. Drain sediment from fuel filters (Page 128).
5. Clean air cleaner dust cup and precleaner (Pages 136-138).
6. Check and lubricate combine (Pages 46-62).

**IMPORTANT: When operating the combine in below freezing temperatures, be certain the rotary screen is free to turn before starting the engine. An accumulation of snow or frozen moisture could prevent the rotary screen from turning, resulting in belt failure.**

The rotary screen drive must be engaged whenever the engine is running.

**IMPORTANT: Rotary screen drive must be fully disengaged before removing or replacing screen door.**

## Removal of Door

1. Remove vacuum duct by loosening four thumb screws and sliding toward front of combine.

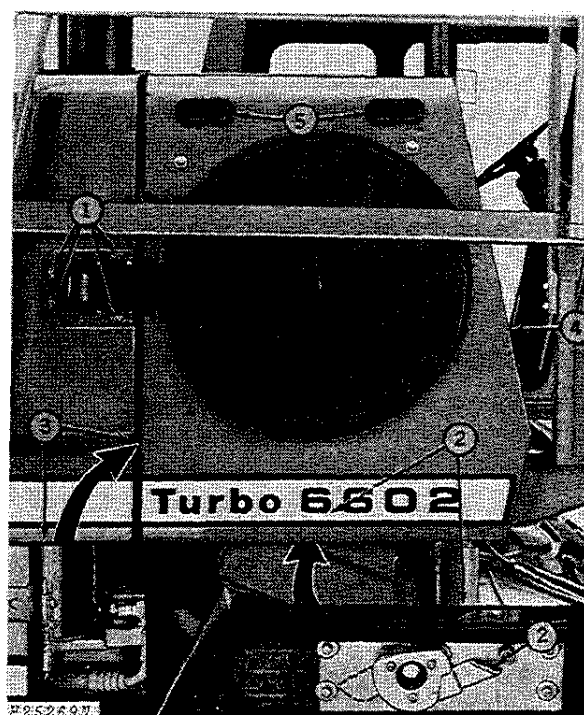

2. Disengage rotary screen drive by moving handle rearward (to open position). Combine is shipped with drive disengaged.

3. Release latch at lower rear corner of door.

4. Release latch on corner frame.

5. Pull door out at bottom and using hand holes in rotary screen door, lift door straight up.

**NOTE: Be certain to check rotary screen and drive for proper adjustment (see pages 134, 135) before reinstalling rotary screen door.**

## Installation of Door

**NOTE: Rotary screen drive handle must be in open position.**

Using hand holes in rotary screen door, lower door down into position. Upper clips must be hooked and lower front support pin must align with hole in frame.

Latch door to corner frame. See step 4.

- Lock latch at lower rear corner of door. See step 3.

Engage rotary screen drive by moving handle forward to operating position. See step 2.

Slide vacuum duct in under flange, then tighten thumb screws. See step 1.

**IMPORTANT: Adjust vacuum duct as outlined on page 135.**

When starting the engine after the combine has been idle for an extended period, pull the fuel shut-off all the way out, and crank the engine with the starter until the engine oil pressure gauge registers pressure. Do not operate the starter more than 30 seconds at a time. After pressure is indicated, move the throttle to the slow idle position, make certain fuel shut-off is all the way in, and start the engine.

## STARTING ENGINE

 **CAUTION:** Before starting the combine engine, be certain there is plenty of ventilation. Never operate the combine in a closed building.

1. If the engine has not been operated for a long period of time, or if the fuel tank has run dry, bleed the entire fuel system to remove air bubbles; see page 129.

**IMPORTANT:** Never let the fuel tank run dry.

2. Disengage platform electromagnetic clutch switch, separator control lever, and grain tank unloading auger lever.

3. Place gearshift lever in neutral.

4. Place the hydrostatic speed range lever in neutral.

5. Move throttle lever to the slow idle position.

6. Make certain fuel shut-off is pushed all the way in.

7. Turn key clockwise to the first stop. Check that alternator indicator light glows red.

8. Turn key further clockwise and hold until engine starts. Release key immediately when engine starts.

**IMPORTANT:** When starting engine, never hold key in start position for more than 30 seconds. If engine does not start within 30 seconds, allow at least 2 minutes for proper cooling of starter. Be certain to pause a few seconds after a false start to be certain starter has stopped completely.

*NOTE: If the prevailing temperature is 40°F (4°C) or lower, it may be necessary to use the cold weather starting aid to start the engine.*

To inject starting fluid, press starting aid button located on instrument panel (button marked with decal).

Stop injecting fluid after the engine starts. If the engine begins to die during the first few minutes of operation, inject another "shot" of fluid.

**IMPORTANT:** Fluid can must be left in tray, even if empty, to prevent dirt from being drawn into the engine. To avoid damage, turn engine with starter one or two revolutions before injecting starting fluid. Inject starting fluid only while the engine is turning.

If engine fails to start, see TROUBLE SHOOTING, page 154-159.

**IMPORTANT:** Do NOT tow combine to start engine.

9. Make certain the oil pressure gauge registers pressure and the alternator indicator light goes off. If not, stop engine and determine the cause.

10. Idle the engine for several minutes to warm up engine and to insure turbocharger lubrication before accelerating, applying a load, or transporting.

Should the engine be killed when operating under load, immediately restart the engine to prevent overheating of turbocharger parts, caused when the flow of oil for cooling and lubrication is stopped.

11. Engage the separator and operate at 1500-1800 engine rpm for 5 to 10 minutes. Monitor oil pressure and water temperature and check for oil leaks.

12. For the first 30 minutes, the combine should be operated at 25% slower ground speed. Engine must be operated at full throttle to maintain correct separator speed.

This will give the operator a chance to see that the combine is functioning properly.

## STOPPING ENGINE

1. Place the hydrostatic speed lever in neutral.

2. Place the gearshift lever in neutral.

**3. Allow the engine to idle a few minutes to cool the engine and turbocharger.** (Lubrication and cooling of the turbocharger and some engine parts is provided by the engine lubricating oil. Sudden stopping of a hot engine may allow some parts to overheat and cause possible damage.) Allow the temperature gauge needle to drop well into the white range on the dial.

4. Move the throttle lever to the rear, pull out the fuel shut-off, and then turn the key off.

**IMPORTANT:** Push fuel shut-off back in immediately after the engine has completely stopped, to prevent difficult restarting.

5. If it is necessary to add engine oil, see recommendations on pages 44, 45.

## COLD WEATHER OPERATION

### Fuel System

Use winter-grade fuel. Fill fuel tank at end of the day's run to prevent moisture from condensing in tank.

### Cooling System

Drain, flush, and fill cooling system with a recognized brand of radiator sealer and antifreeze solution. Use a permanent-type (ethylene glycol) antifreeze solution containing rust inhibitors and without stopleak additive. This type of antifreeze is resistant to evaporation when heated.

Quarts (litre) of Ethylene Glycol Required at Lowest Expected Temperature		
+20°F (-7°C)	6	(5.68 l)
+10°F (-12°C)	9	(8.52 l)
0°F (-18°C)	12	(11.36 l)
-10°F (-23°C)	14	(13.25 l)
-20°F (-29°C)	16	(15.14 l)
-34°F (-37°C)	18-1/2	(17.51 l)

### Automatic Leveling System

Fill fluid container, located on lower left-hand side of separator, with 50 percent water and 50 percent permanent-type (ethylene glycol) anti-freeze solution.

### Batteries

When temperature drops below freezing, batteries must be fully charged. A discharged battery freezes more quickly than one fully charged.

In freezing weather, do not add water to batteries unless engine is going to be run. Water will freeze as it will not mix with electrolyte until the alternator passes a charging current through the batteries.

**IMPORTANT: If booster batteries are required, see instructions on pages 117 and 118.**

### In-Block Coolant Heater

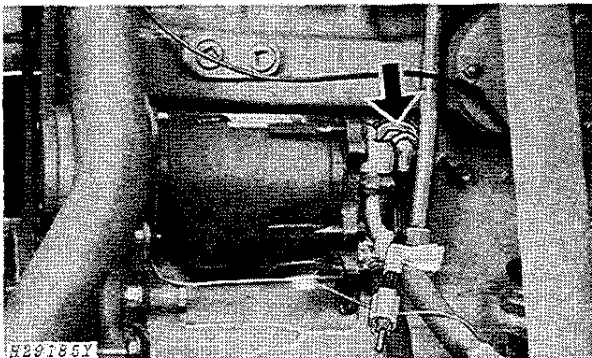

Coolant Heater

The optional coolant heater has a 1000-watt, 115-volt heating element. It mounts in the frost plug opening in the left-hand side of the engine block. By warming the engine, the heater reduces oil drag, eases starting, and shortens warm-up time.

Time required to sufficiently heat the coolant depends on how cold it is. 5 hours may be required at temperatures above 0°F (-18°C). Lower temperatures may require up to 8 hours.

**⚠ CAUTION: To avoid shock or hazardous operation, always use a three wire heavy-duty electrical cord equipped with 3-wire connectors. If a 2- to 3-contact adapter is used at the wall receptacle, always connect the green wire to a good ground.**

### Cold Weather Starting Aid

Diesel engines may be equipped with an ether starting fluid aid which injects atomized ether fluid into the engine air intake system. Normally, ether is used at temperatures below 40°F (4°C).

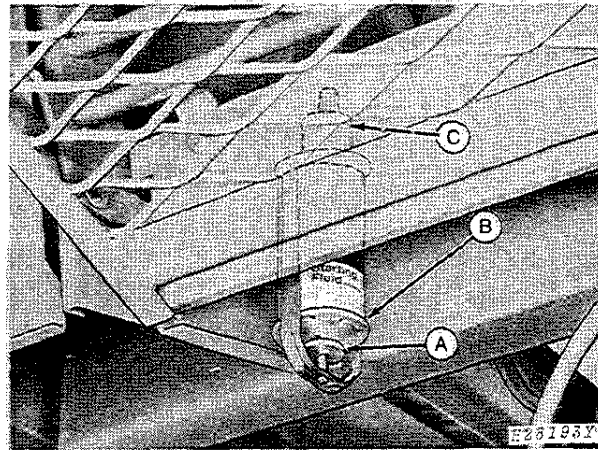

A—Screw B—Tray C—Solenoid

To use the starting fluid aid, remove the safety cap and plastic spray button from can. Loosen screw (A) and place can in starting fluid aid tray (B). Position can directly under electric solenoid. Tighten screw by hand until nozzle of can is securely seated in the solenoid (C).

**IMPORTANT: To avoid damage, turn engine with starter one or two revolutions before injecting starting fluid. Inject starting fluid only while the engine is turning.**

To inject starting fluid, press starting aid button (yellow with symbol) located on instrument panel.

Stop injecting fluid after the engine starts. If the engine begins to die during the first few minutes of operation, inject another "shot" of fluid.

**IMPORTANT: Fluid can must be left in tray, even if empty, to prevent dirt from being drawn into the engine.**

**⚠ CAUTION: Ether starting fluid is highly flammable. Store starting fluid cans where they will not be subject to extreme cold or warm temperatures. For best results, store fluid at room temperature.**

## HOT WEATHER OPERATION

The combine has an antifreeze solution in the cooling system and a 7 psi (0.50 bar) pressure valve in the radiator cap. This pressurizes the cooling system so all components must be tight and in good condition for proper operation. Loss of pressure will result in overheating and loss of coolant.

The antifreeze solution should be left in the cooling system during hot weather operation. If coolant is lost or drained out and freezing temperatures are not anticipated, the cooling system can be protected against corrosive action by using Summer Engine Coolant Conditioner.

The Summer Engine Coolant Conditioner is available under Part No. T19566, and may be purchased from your John Deere dealer.

To install the Summer Engine Coolant Conditioner, perform the following:

Drain and flush cooling system and add two 32-oz. (0.9463 l) cans of Summer Engine Coolant Conditioner to the cooling system following directions on the container.

**IMPORTANT:** Summer Engine Coolant Conditioner is **NOT AN ANTIFREEZE** or a cooling system sealer. Drain system and fill with recommended antifreeze solution as required for winter protection. When antifreeze solution is in system, it should not be necessary to use the Conditioner; however, should severely corrosive water conditions be present, the Conditioner is compatible with antifreeze solutions.

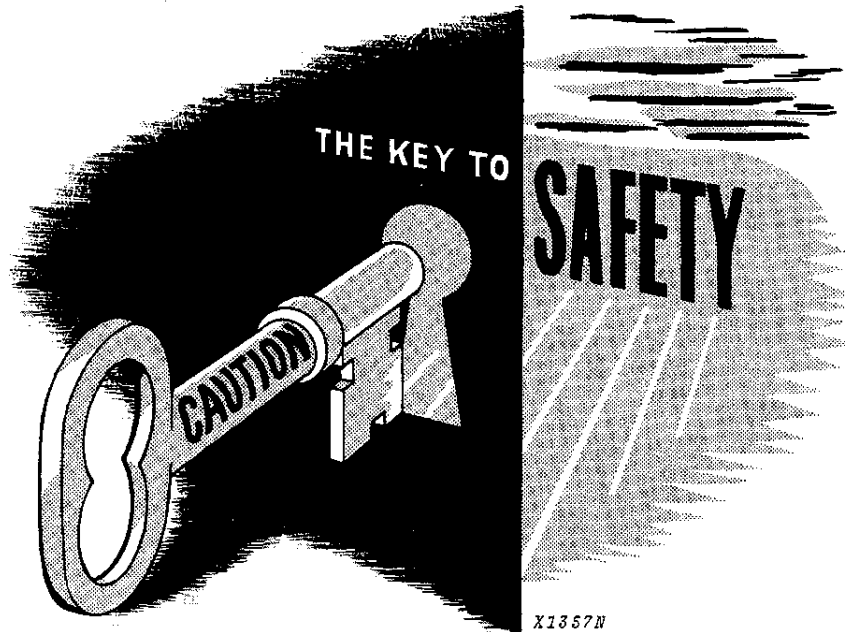

## OPERATOR'S PLATFORM COMPONENTS

### OPERATOR'S CAB CONTROLS

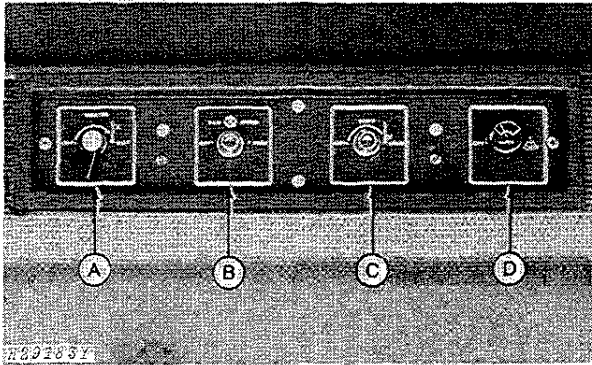

- A—Heater Temperature Control Switch
- B—Pressurizer Fans Switch
- C—Air Conditioner Temperature Control Switch
- D—Windshield Wiper Switch

The operator's cab controls are located in the cab headliner. The radio is located in the rear right-hand corner of the cab.

The air outlets are adjustable by rotating to control air flow into the cab. An air deflector on one outlet will further control air flow.

### PRESSURIZER SYSTEM

The switch (B) controls the fans which pressurize the cab. This is a three-speed switch with the highest speed obtained by turning the switch clockwise as far as it will go.

**IMPORTANT:** Pressurizer fans must be operating whenever the heater or air conditioner is in use.

### AIR CONDITIONER SYSTEM

**CAUTION:** The air conditioner system should only be serviced by a qualified serviceman.

This switch (C) is a thermostatic-type switch which maintains the desired temperature.

Cool air is controlled by turning the switch (C) clockwise toward "COLD." Turning the switch all the way to the "COLD" position will provide maximum cooling.

### Air Recirculator

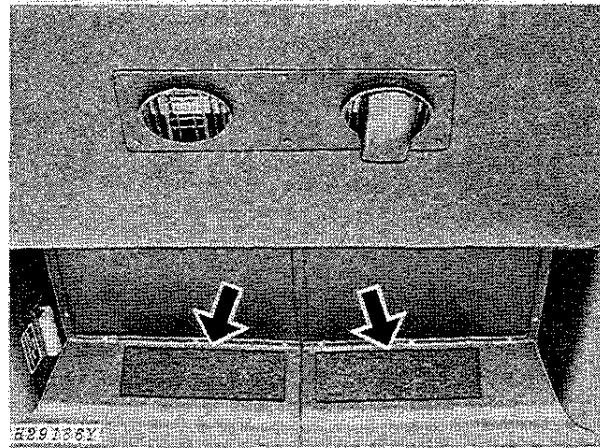

Under normal operating conditions, The air recirculator, is located in the rear of the cab roof.

### Air Intake

The air intake, which is mounted on the rear of the cab roof, provides additional air intake to the cab.

### HEATER SYSTEM

Heat is controlled by turning the heater control switch (A) clockwise. Turning the switch all the way to the "HOT" position will provide maximum heating.

**IMPORTANT:** The pressurizer system must be in operation when the heater is in use.

## OPERATOR'S SEAT

### Operator's Seat (Standard Without Cab)

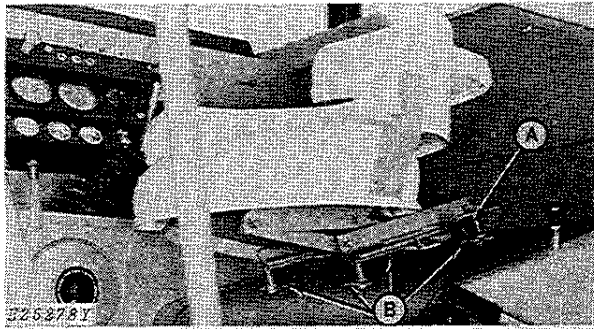

The operator's seat moves forward and rearward or up and down to accommodate individual height and to allow greater accessibility to all controls.

Use only warm water and mild soap to clean the seat cushions. NEVER USE SOLVENTS.

#### Adjusting Seat Forward or Rearward

While sitting in the seat, push lever (A) forward as far as possible and by using your weight, adjust seat to desired position and then release lever (A).

#### Adjusting Seat Up or Down

Remove four spring locking pins (B), raise or lower the seat to the desired height then reinsert spring locking pins (B).

### Personal-Posture Seat (Standard with Cab)

The Personal-Posture seat is adjustable in five different respects and is upholstered in durable cloth fabric for operator comfort.

Seat fabric should be frequently vacuum cleaned or brushed with a soft bristle brush to remove loose dirt and dust. Fabric cleaners may be used to clean normal soilage on fabric. Grease and oil stains on fabric may be cleaned with commercially available solvent-type spot removers. Follow solvent label directions carefully.

Use only warm water and mild soap to clean the arm rests. Never use solvents.

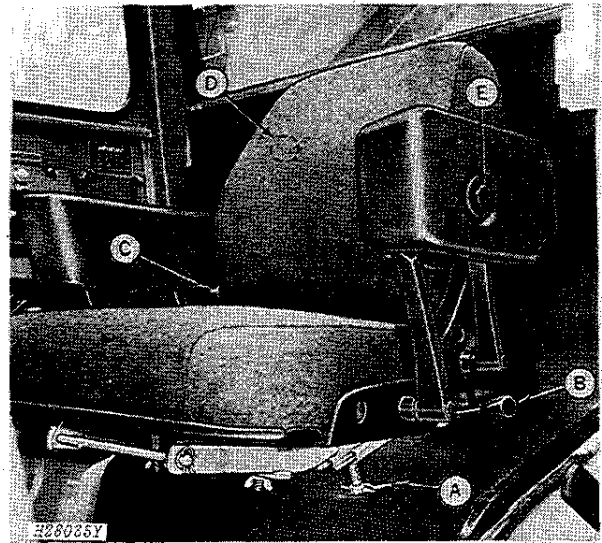

- |                               |                          |
|-------------------------------|--------------------------|
| A—Spring Locking Pins         | D—Lumbar Support Knob    |
| B—Lever                       | E—Armrest Release Button |
| C—Backrest Angle Control Knob |                          |

#### Adjusting Seat Up or Down

Remove the four spring locking pins (A). Raise or lower the seat to the desired height. Replace spring locking pins (A).

#### Adjusting Seat Forward or Rearward

Sit in the seat, push lever (B) forward as far as possible and by using your weight, adjust seat to the desired position, and release lever (B).

#### Adjusting Backrest Angle

The backrest is adjustable through a 10° angle. To change the angle to the desired position, raise or lower the backrest angle control knob (C).

#### Adjusting Lumbar Support

A lumbar support mechanism is built into the backrest. This support is adjustable to five different pressures against the lower portion of the back. Move knob (D) up or down to adjust lumbar support to the desired position.

#### Adjusting Armrest Height

Armrest height is adjustable to five different positions. To adjust the height, press the armrest release button (E), move armrest up or down to the desired position, and release button.

## STEERING COLUMN

The steering column is adjustable to one of four positions for individual arm lengths. This allows better visibility and greater accessibility to the steering wheel and controls on the steering column.

### Steering Column Control

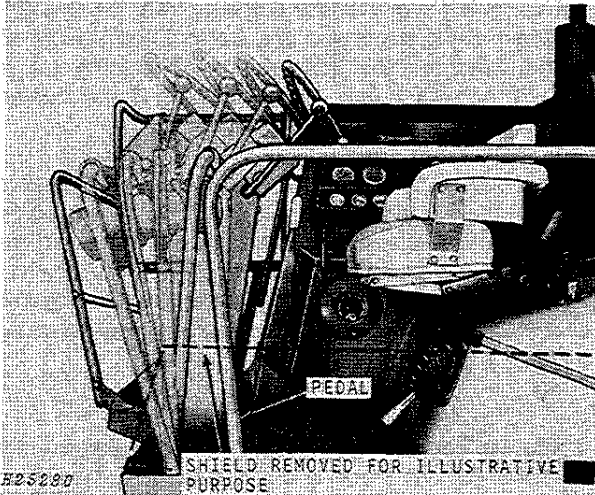

To adjust steering column, push pedal down, position column to desired setting, and release pedal.



## LADDER AND CATWALK

A pull-down ladder and catwalk provide easy access to the operator's platform.

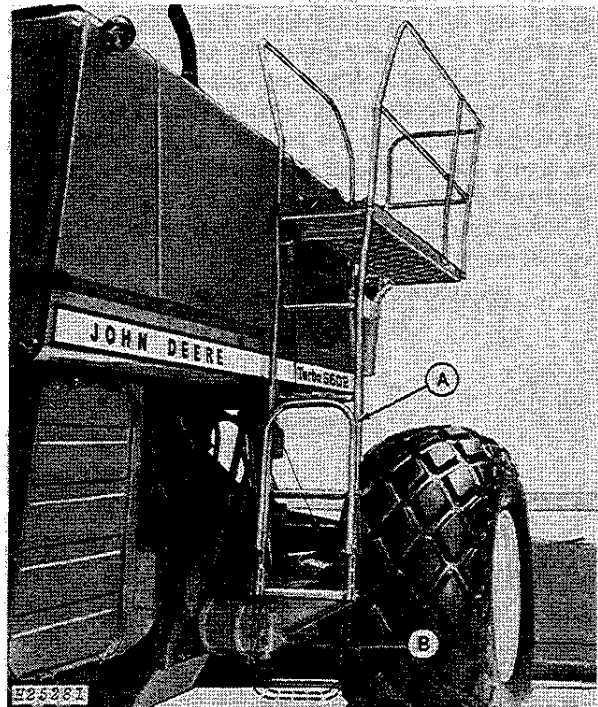

Pivot the lower section of the ladder down (position [B]) for access to the operator's platform.

Pivot the lower section of the ladder up (position [A]) for storage.

Do not operate the combine unless the ladder is in storage position.

## PROPULSION CONTROLS

### GEARSHIFT LEVER

Move hydrostatic drive lever to "N" neutral, then shift lever to desired position. There is no reverse position as all forward gears are also reverse gears.

**⚠ CAUTION:** When operating combine and transmission is under load you cannot move gearshift from the gear it is in. It is necessary to move the hydrostatic drive lever to "N" neutral first before shifting.

When towing combine, place the speed range lever in neutral.

### HYDROSTATIC DRIVE SPEED RANGE LEVER

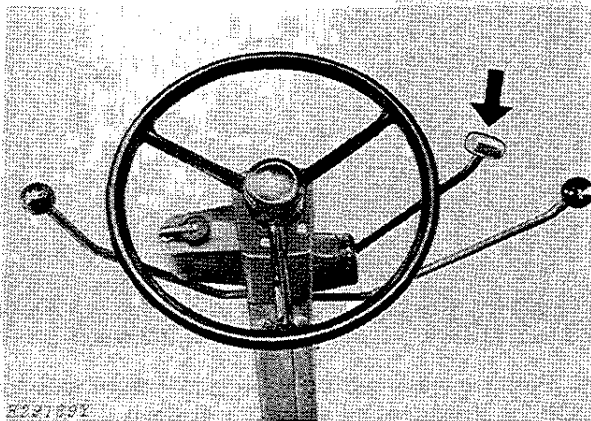

To move combine forward, place gearshift lever in desired transmission gear and push the speed range lever forward.

To stop combine, return the speed range lever to neutral against the stop. Place the gearshift lever in neutral.

To move combine in reverse, place the gearshift lever in desired transmission gear and move the speed range lever up and pull rearward.

### TRANSMISSION OIL PRESSURE INDICATOR LIGHT



GLOWS RED WHEN TRANSMISSION OIL PRESSURE IS LOW

X 2237

The indicator light glows red when the oil pump in the transmission is not functioning properly, when the oil pressure is too low, or when the hydrostatic drive is in reverse range.

To check operation of the light, turn the key switch on; the light should glow. If light does not glow, check wire connections on the switch at the transmission.

The light will go off when the engine is at full throttle and the speed range lever is positioned at mid-range or above. If the light does not go off, stop combine immediately and determine the cause.

### NEUTRAL STARTING SWITCH

This switch prevents the combine from being started when the transmission is in gear. Check the wires to the switch on the transmission periodically (page 105). If the switch fails, see your John Deere dealer.

### STEERING MECHANISM

The steering mechanism is operated by full-time power steering, sometimes referred to as hydrostatic steering. The steering control wheel activates the valve, located under the operator's platform, which in turn allows oil to flow through steel lines to the hydraulic steering cylinder, thus turning rear steering wheels to desired position.

### PARKING BRAKE

The parking brake locks the wheel brakes so the combine cannot move if left unattended. Never attempt to move the combine with the parking brake lever engaged.

#### Parking Brake Lever

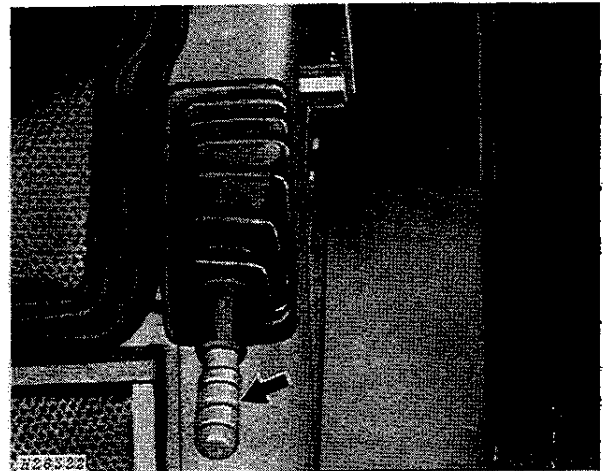

To engage, pull lever upward.

To disengage, push lever downward.

#### Parking Brake Indicator Light and Buzzer

This light flashes red and buzzer sounds when the ignition is on and the lever is engaged. If the light is flashing and buzzer sounding, release the lever before moving the combine.

## HYDRAULIC BRAKES

These are wheel brakes and can be used to assist in turning to left and right. When pedals are used together, a quick stop is assured.

**CAUTION:** Reduce travel speed by moving ground speed lever before applying brakes.

When stopping the combine, press on both brake pedals. Uneven application of brakes will draw combine to one side. Apply brakes evenly at transport speeds.

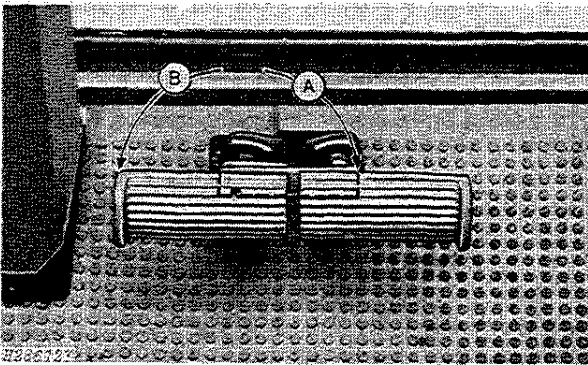

A—Brake Lock Position for Both Brakes Together  
B—Brake Unlocked Position for Single Brakes Individually

When transporting the combine or traveling at high speeds, couple the pedals together (A) with the brake lock.

Quick stops can result in combine nosing forward. Drive with the care necessary to allow controlled application of brakes at all times.

### Brake Line Quick Disconnect Couplings

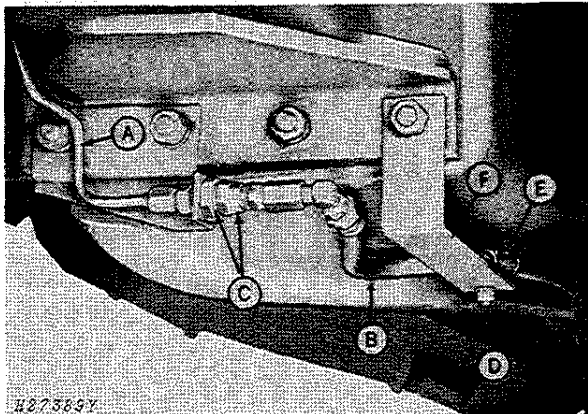

A—Brake Line C—Fittings E—Clamp  
B—Brake Hose D—Cap Screw F—Bracket

Right-Hand Brake Line Illustrated

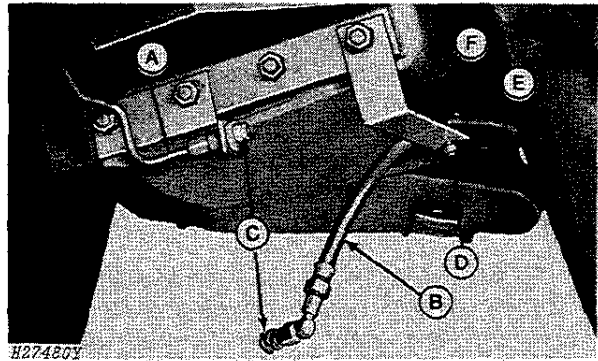

A—Brake Line C—Fittings E—Clamp  
B—Brake Hose D—Cap Screw F—Bracket

Right-Hand Brake Line Illustrated

When removing wheels and final drives for transporting combine, disconnect brake line (A) and brake hose (B) from coupling by unscrewing fittings (C).

Remove cap screw (D) from clamp (E), slip clamp from brake hose, and secure clamp (E) to bracket (F) with cap screw (D), lock washer, and nut.

Reconnect in reverse order.

**NOTE:** Quick disconnect couplings do not require any bleeding of brake lines.

## TIRES

Proper inflation is essential to the long life of a tire. Lack of air pressure allows the tire to slip on the rim and buckle the side walls. Overinflation causes uneven tread on tire structure and may result in ruptures due to impact with stones, roots, or ruts. It also causes excessive tread wear and allows tire to cut in more on soft ground.

**IMPORTANT:** Never operate combine with tires at shipping pressure.

Check air pressure in all tires every 50 hours. Inflate or deflate tires to obtain proper air pressure as given in tire inflation chart (page 102).

Keep valve caps screwed finger-tight onto valve stems. This will prevent dust, fine gravel, mud and other foreign material from accumulating in the valve core and permitting the compressed air to escape.

Correct toe-in (page 102) of the rear wheels must be maintained; otherwise the combine will be difficult to steer and the tires will be subject to excessive wear.

## TRANSPORTING

The combine can be transported by driving it under its own power, carrying it on a truck, or by towing it.

 **CAUTION: Do not tow combine with rope. Energy stored in rope, if it should break, could cause bodily injury.**

If combine is to be towed, place the gearshift lever in its "TOW" position and the hydrostatic drive speed range lever in neutral. The combine can be safely towed at a maximum speed of 20 mph. The grain tank must be empty when transporting.

 **CAUTION: Do not tow faster than 20 mph. Towing at speeds higher than 20 mph could cause damage to tires, transmission, final drives, or cause oil to blow out breather plugs in final drives.**

Couple the brake pedals together with the brake lock (page 13).

Reduce the width of the combine by folding the unloading auger back along the separator and removing the platform. Over-all dimensions are given on page 179.

If combine is to be transported long distances, rotate lock plate in leveling control switch box to hold switch lever in its mid position and close the needle valve. See page 108. Also disengage the leveling mechanism by placing the leveling control cut-out switch in the "OFF" position (page 43).

If the feeder house is removed, the hydraulic cylinders must be wired or supported by chains no closer to separator support channel than 14 inches (357 mm). Damage may result to hoses if carried too close.

If the platform is left on, raise it to a position allowing good visibility.

Reduce the spread of noxious weed seeds by thoroughly cleaning the combine before leaving one field and going to the next.

Sweep trash and straw from the outside of combine. Open doors at bottom of elevators, remove grain tank drain hole cover, and run combine until all straw, trash, and grain are removed from inside. Shut off combine engine. Clean out shoe grain supply augers (page 88).

The combine is equipped with a slow moving vehicle emblem on the rear hoods, lights, and grain tank reflectors for transporting protection. Keep the emblem, reflectors, and lights clean.

 **CAUTION: Turn on the flashing warning lights whenever traveling on highway except when such use is prohibited by law.**

If the combine is to be transported on a truck, disconnect brake lines at coupling, remove hose from clamp and leave line and hose with final drive assembly when removed. See page 13. Remove the main drive wheel and final drive assemblies from combine to reduce width.

Make certain to reinstall telescoping drive shafts and readjust wheel brake adjusting nuts before operating combine under its own power.

 **CAUTION: Brake system must be free of air before towing the combine or transporting under its own power. See page 103 for bleeding the brake hydraulic system.**

When transporting at highway speeds with the engine not running, plug the engine exhaust to prevent damage to the turbocharger.

## FIELD AND HIGHWAY LIGHTING

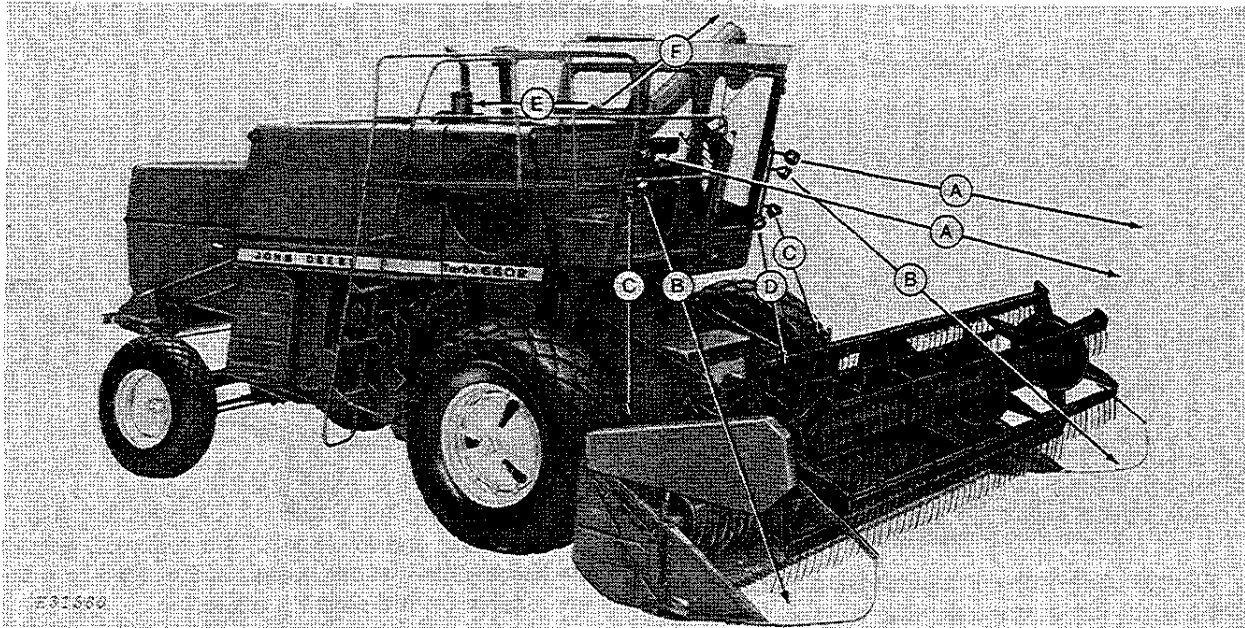

The combine is equipped with the following nine lamps:

Two 80 watt, dual beam lamps for field and road operation (A).

Two 60 watt lamps for illuminating both ends of the header (B).

Two 18 watt lamps for illuminating the stubble areas in front of the combine drive tires (C).

One 18 watt lamp for illuminating the center of the header auger (D).

One 18 watt lamp for illuminating the grain tank (E).

One 35 watt lamp for illuminating the unloading auger (F).

For maximum illumination from all nine lights, be certain lights are positioned correctly as illustrated.

Loosen bolt in light mounting clamp and position light in the desired position.

**FIRST POSITION (OFF):** All lamps are off.

**SECOND POSITION WARNING (W):** Rear warning lights (amber lens) are lit.

**THIRD POSITION HIGHWAY (H):** Low beam in both 80 watt lamps, both 60 watt lamps, and the flashing warning lights are lit.

**FOURTH POSITION FIELD (F):** Both high and low beams in the 80 watt lamps and all the other lamps are lit.

**TURN SIGNALS:** When operating combine with light switch on W or H, the flashers will operate at 60 flashes per minute. When turn signal is set for right-hand turn, the right-hand light will flash 90 flashes per minute while the left-hand light will burn continuously. The opposite will happen for left-hand turn.

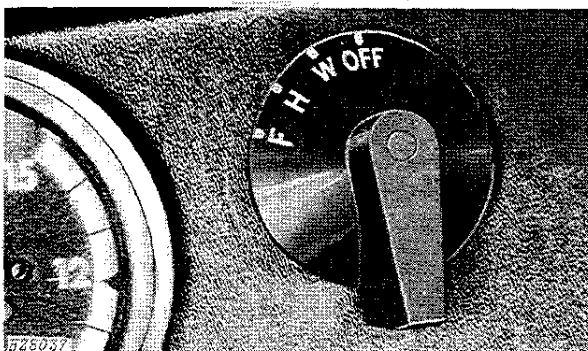

**CAUTION:** When transporting on a road or highway, a flashing warning light on each side of the combine and one taillight on left-hand side provide a warning to operators of vehicles approaching from the rear.

## COMBINE FUNCTION CONTROLS

### HEADER CONTROLS

#### Header Electromagnetic Clutch Switch

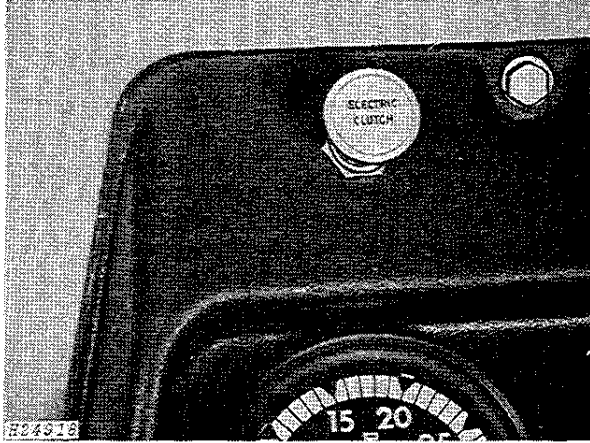

This switch engages or disengages an electromagnetic clutch for the header. Disengaging the clutch permits stopping the header and feeder house while the separator continues to run.

Push switch in to disengage clutch. Pull switch out to engage clutch.

#### Header Height Control Lever

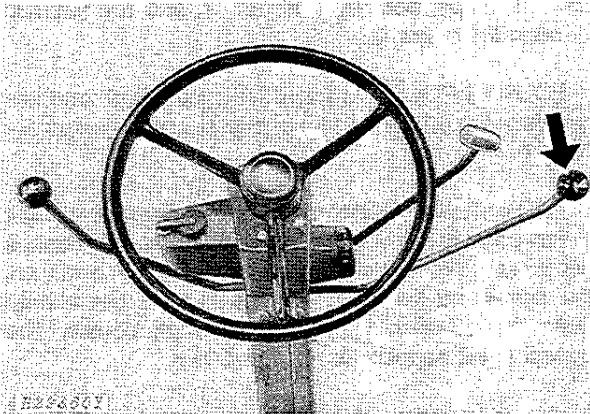

Height of the header can be changed by moving the height control lever located on the steering column. As a safety measure, the height cannot be changed unless the engine is running.

To lower the header, push the lever forward.

To raise the header, pull the lever rearward.

Speed of lowering can be regulated on the hydraulic control valve (page 110).

#### Reel Lift

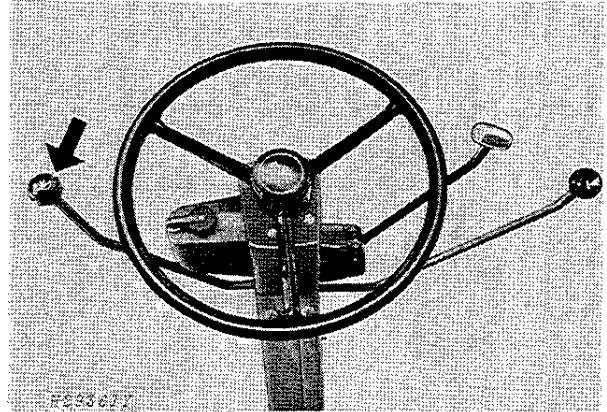

The raising and lowering of the reel and varying the speed of the feeder house, is controlled by a lever located on the steering column.

To lower the reel, push the lever forward.

To raise the reel, pull the lever rearward.

#### Reel Drive

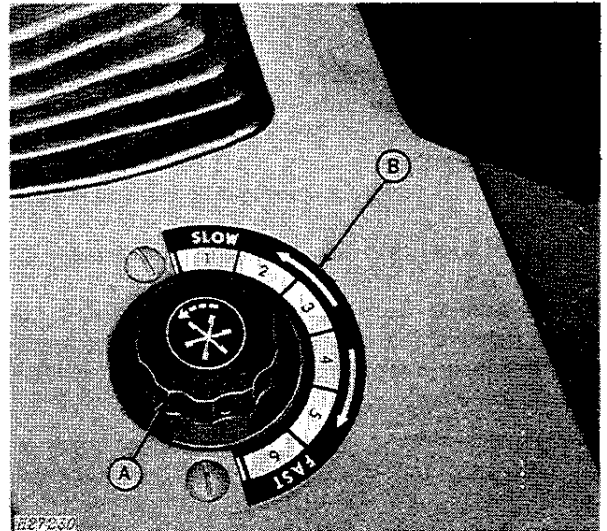

A—Speed Control Knob      B—Speed Reference Indicator

Reel speed may be varied from 5 to 40 rpm with a pickup reel and from 8 to 64 rpm with a bat reel, by turning the control (A) on the console.

To increase reel speed, turn knob toward "FAST."

To decrease reel speed, turn knob toward "SLOW."

Use the reference indicator (B) as a guide to return to the speed previously found best suited for a particular crop or field condition.



**Suggest:**

**If the above button click is invalid.**

**Please download this document**

**first, and then click the above link**

**to download the complete manual.**

**Thank you so much for reading**

## SEPARATOR CONTROLS

### Separator Throw-Out Control Lever

The separator is engaged or disengaged by moving the separator control lever on the operator's platform.

**CAUTION:** Do not engage separator until everyone is standing away from moving parts or belts.

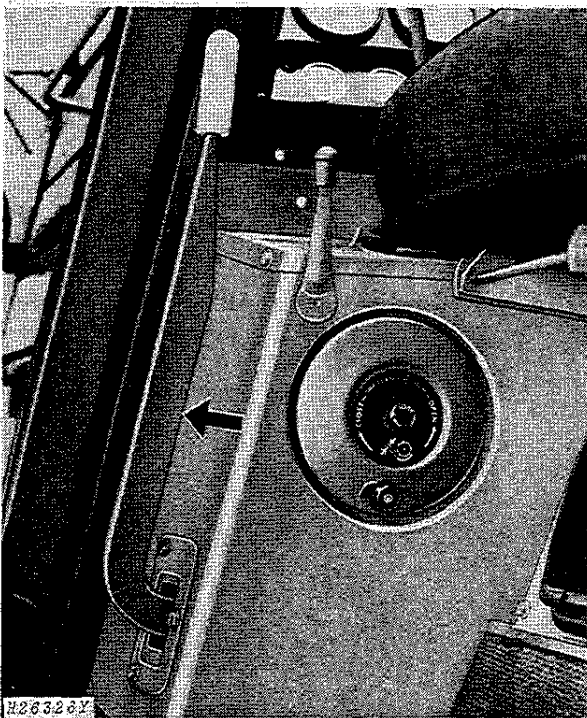

To engage separator, push lever forward; to disengage separator, pull lever rearward.

### Cylinder Speed Control Ratchet

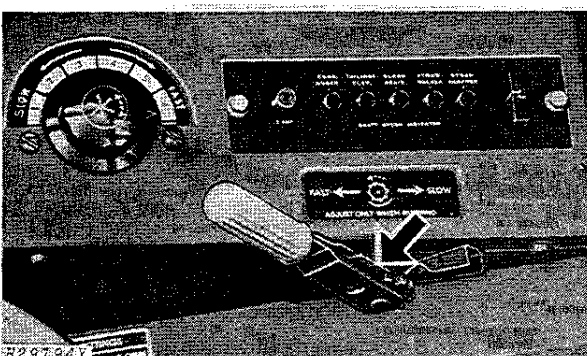

Before changing cylinder speed, place ratchet, pawl in the position of ratchet handle movement.

**IMPORTANT:** Adjust cylinder speed only when the separator is engaged and the engine is running at full rpm.

See Suggested Settings Chart, page 37.

To increase speed, move ratchet toward "FAST."

To decrease speed, move ratchet toward "SLOW."

### Concave Opening Control Wheel (Rasp-Bar and Spike-Tooth)

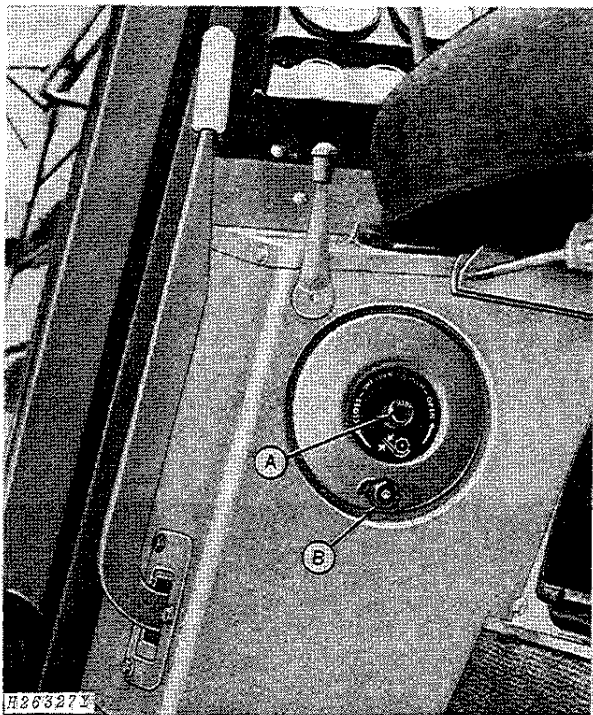

A—Locking Knob

B—Wheel with Knob

Loosen locking knob (A).

To open the concave, turn the wheel (B) toward "OPEN."

To close the concave, turn the wheel toward "CLOSE."

Tighten locking knob.

**<https://www.ebooklibonline.com>**

Hello dear friend!

Thank you very much for reading.

Enter the link into your browser.

The full manual is available for immediate download.

**<https://www.ebooklibonline.com>**