

4640 AND 4840 TRACTORS



JOHN DEERE

OPERATORS MANUAL 4640 AND 4840 TRACTORS

OMR65463 E1 English

JOHN DEERE TRACTOR WORKS
OMR65463 E1

LITHO IN THE U.S.A.
ENGLISH



IMPORTANT WARRANTY INFORMATION

The warranty on this tractor appears on your copy of the purchase order which you should have received from your dealer when making your purchase. This warranty provides you the assurance that John Deere will back its products where defects appear within the warranty period. In some circumstances, John Deere also provides field improvements, often without charge to the customer, even if the product is out of warranty.

Warranty and field improvements are a part of John Deere's product support program for customers who operate and maintain their equipment as described in this manual. Should the equipment be abused, or modified to change its performance beyond the original factory specifications, the warranty will become void and field improvements may be denied. Setting fuel delivery above specifications or otherwise overpowering machines will result in such action.



This safety alert symbol indicates important safety messages in this manual. When you see this symbol, be alert to the possibility of personal injury and carefully read the message that follows.



Worldwide symbols are used to assist identification and operation. In this manual, an identifying symbol is placed by the instructions like the example at left for the symbol on the engine oil pressure gauge. The cylinder block in the symbol represents the engine, the drop signifies oil, and the arrows indicate pressure. Regardless of the language used in a nation, this symbol means engine oil pressure without translation.

This operator's manual contains SI Metric equivalents which follow immediately after the U.S. customary units of measure.

"Right-hand" and the "left-hand" sides of the tractor are determined by facing in the direction of tractor forward travel.

Record your tractor serial numbers on page 129. Provide this information to your dealer when ordering parts.



R29422

John Deere 4840 Tractor



Contents

Safety	2
Controls and Instruments	6
Operator's Station	9
Engine Break-in	14
Prestarting Checks	15
Operating the Engine	17
Operating the Tractor	24
Rockshaft and Three-Point Hitch	34
Remote Hydraulic Cylinders	44
Drawbar and PTO	50
Ballast	57
Wheels, Tires, and Tread	63
Transporting	72
Lighting and Signals	74
Fuels and Lubricants	77
Lubrication and Maintenance	81
Service	93
Storage	116
Trouble Shooting	119
Specifications	126
Index	130
Lubrication and Maintenance Record	138
Daily Maintenance	138

<https://www.ebooklibonline.com>

Hello dear friend!

Thank you very much for reading.

Enter the link into your browser.

The full manual is available for immediate download.

<https://www.ebooklibonline.com>



Safety

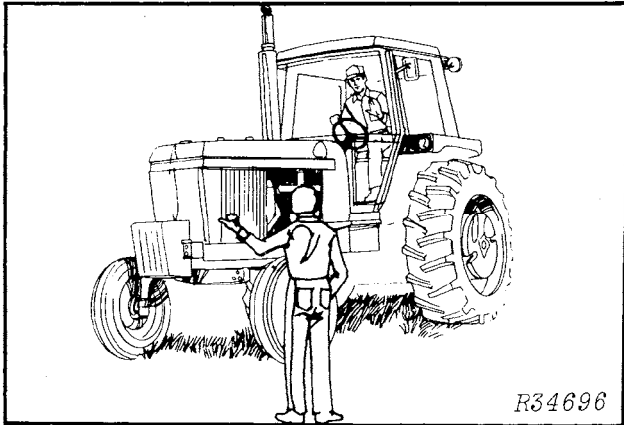

Operate Tractor Safely

Never allow riders on the tractor.

Slow down for hillsides, rough ground, and sharp turns. Couple the brake pedals together before driving at transport speeds.

To avoid exhaust gas hazards, never run the engine in a closed building.



Avoid Tip-Overs

Use a seat belt under almost all operating conditions.

Avoid holes, ditches, etc. which may cause the tractor to tip, especially on hillsides.

Never drive near the edge of a gully or steep embankment—it might cave in.

Driving forward out of a ditch or mired condition or up a steep slope could cause tractor to tip over rearward. Back out of these situations if possible.

Hitch towed loads only to the drawbar. When using a chain, take up the slack slowly.

Never modify structural members of SOUND-GARD® Body by welding, bending, drilling, grinding or cutting, as this might weaken the structure. If any component is damaged, replace it. Do not attempt repairs.

For an emergency exit, SOUND-GARD Body windows can be opened. Remove the quik-lock pins and headed pins from window latches, and push window wide open.

Handle Chemicals Properly

SOUND-GARD Body air filters are not designed to filter out harmful chemicals. When using agricultural chemicals, follow the instructions given in the implement operator's manual and those given by the chemical manufacturer.

Transport Safely

Never tow the tractor faster than 20 mph (32 km/h).

Before descending a steep hill, shift to a lower gear to control the tractor with little or no braking. Never coast downhill.

A towed load of more than twice the weight of the tractor should have brakes. If it does not, drive slowly and avoid hills. Avoid hard applications of the brakes when pulling heavy loads.

When operating the tractor on a road, turn the light switch to the "H" position. Be sure the SMV emblem is visible and clean.

Always dim the headlights before meeting another vehicle. Keep the lights adjusted so they will not blind another driver.

Be sure lighting conforms to local regulations.

Always place transmission in PARK before dismounting. Leaving transmission in gear with engine stopped would NOT prevent tractor from moving.

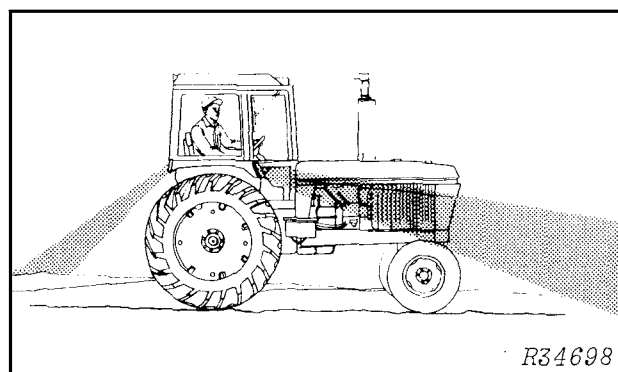

Stay Clear of PTO

Stop the engine and be sure the PTO has stopped before:

- Connecting or disconnecting a PTO shaft
- Making any adjustment to PTO drive train or hitch
- Cleaning out PTO driven equipment

PTO master shield should be in place at all times except when connecting a PTO drive line or for special applications as directed in the operator's manual.

The PTO shaft guard should be in place when the PTO is not being used.

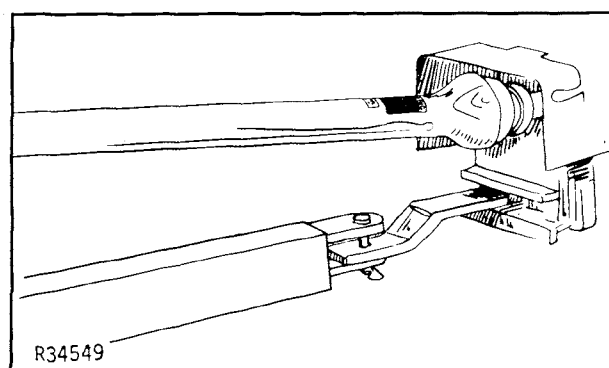

Stay Clear of Moving Tractor

Never try to get on or off a moving tractor.

Before dismounting, place the transmission in park and lower implements to the ground. If tractor is to be left unattended, stop the engine and remove the key.

Never attempt to start or operate the tractor except from the operator's station.

4 Safety

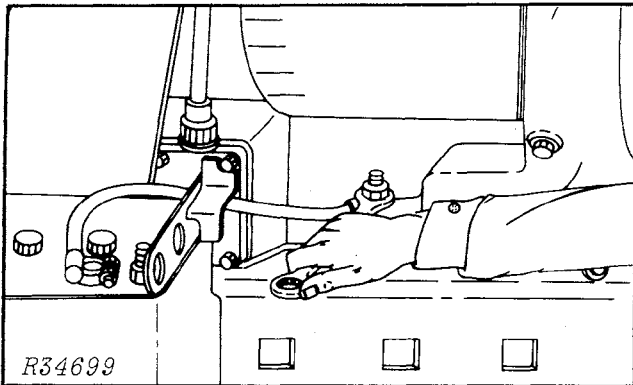

Service Tractor Safely

Do not service the tractor while it is in motion or while the engine is running.

Disconnect the battery ground cable before working on the electrical system or working in any area where you might accidentally contact electrical components.

Avoid Explosions or Fire

Before using booster batteries, read the instructions on page 21. Before connecting or disconnecting a battery charger, turn the charger off to avoid sparks.

Be careful with starting fluid or any type of fuel. Do not refuel the tractor when the engine is hot or running.

Never smoke while handling fuel.

A fire extinguisher, designed to be mounted in your tractor, is available from your John Deere dealer. Be sure to follow operation and service instructions which are packaged with the extinguisher.

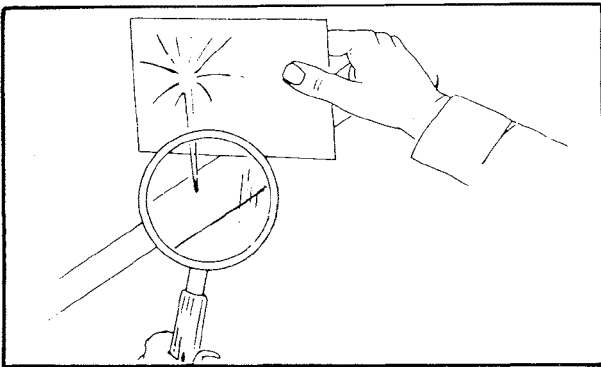

Avoid High-Pressure Fluids

Do not remove the radiator cap when the engine is hot. Shut the engine off and wait until it cools. Then turn the cap to the first stop to relieve pressure before removing it completely.

Escaping fluid under pressure can have sufficient force to penetrate the skin, causing serious injury. Before disconnecting lines, be sure to relieve pressure. Before applying pressure, be sure connections are tight and lines, pipes and hoses are not damaged. Use a piece of cardboard or wood, rather than your hands, to search for leaks.

If injured by escaping fluid, see a doctor at once. Serious infection or reaction can develop if proper medical treatment is not administered immediately.

Before disconnecting brake accumulator or brake valve, relieve all pressure from the accumulator. With engine stopped, pump brake pedals at least 50 strokes, until pedals easily go all the way down.

The accumulator is charged with dry nitrogen to a pressure of 500 psi (3500 kPa) (35 bar). If it needs recharging, have the job done only by a qualified service person and only with dry nitrogen.

Service Tires Safely

Failure to follow proper procedures when mounting a tire on a wheel or rim can produce an explosion which may result in serious injury or death. Do not attempt to mount a tire unless you have the proper equipment and experience to perform the job. Have it done by your John Deere dealer or a qualified tire repair service.

When sealing tire beads on rims, never exceed 35 psi (240 kPa) (2.4 bar) or maximum inflation pressures specified by tire manufacturers for mounting tires. Inflation beyond this maximum pressure may break the bead, or even the rim, with dangerous explosive force. If both beads are not seated when the maximum recommended pressure is reached, deflate, reposition tire, relubricate bead, and reinflate.

Detailed agricultural tire mounting instructions, including necessary safety precautions, are contained in John Deere Fundamentals of Service (FOS) Manual 55, Tires and Tracks, available through your John Deere dealer. Such information is also available from the Rubber Manufacturers Association and from tire manufacturers.

Protect Against Noise

Prolonged exposure to loud noise can cause impairment or loss of hearing.

Wear a suitable hearing protective device such as earmuffs (A) or earplugs (B) to protect against objectionable or uncomfortable loud noises.





Controls and Instruments

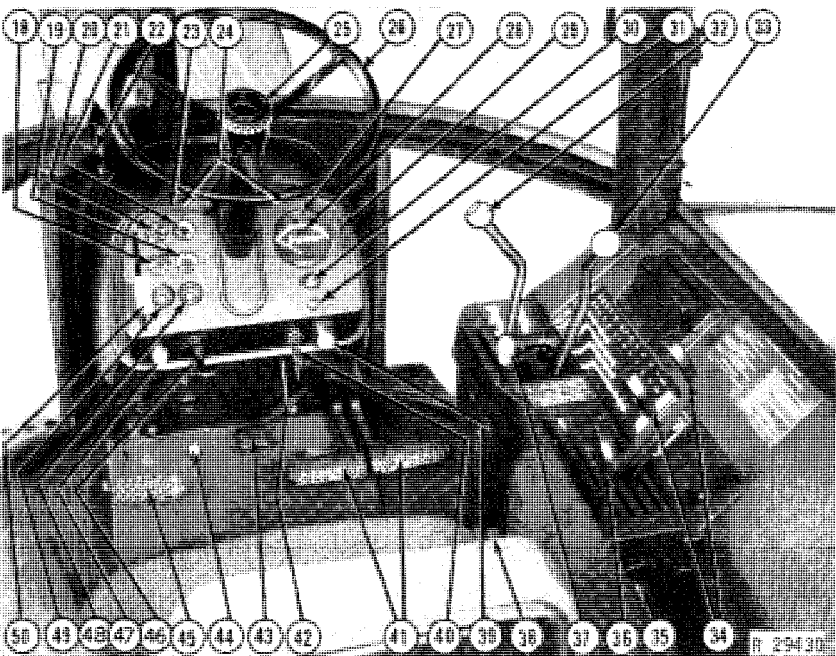
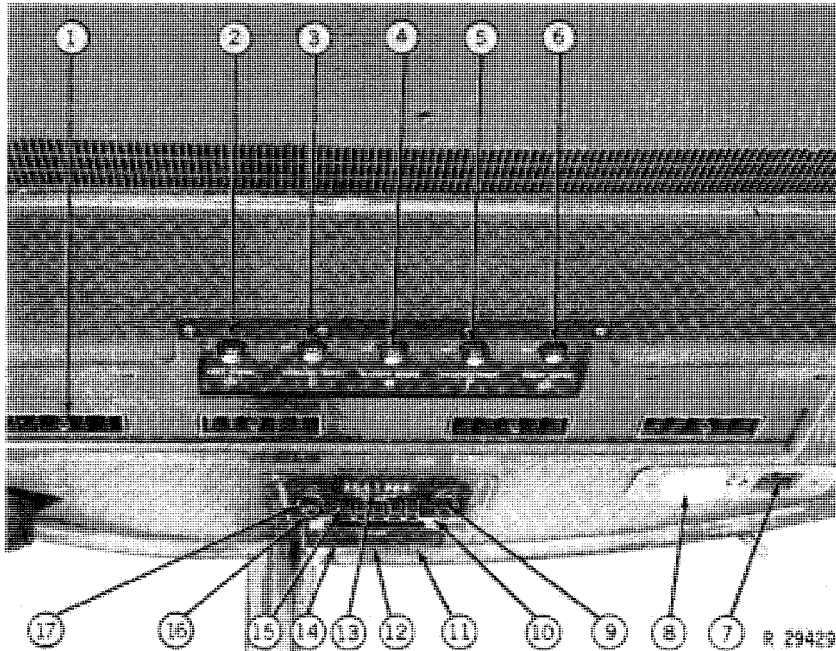

	See Page
1—Air Louver	10
2—Left Wiper Switch	9
3—Air Conditioning Control	9
4—Blower Switch	9
5—Heater Control	9
6—Right Wiper Switch	9
7—Console Lamp	
8—Dome Lamp	
9—Radio Tuning Knob	10
10—Tape Player Channel Selector	10
11—Tape Player Tone Control	10
12—Tape Player Balance Control	10
13—AM-FM Selector	10
14—Tape Player Volume Control	10
15—Radio Tuning Push Buttons	10
16—Radio On-Off/Volume Control	10
17—Radio Tone Control	10
18—Engine Oil Pressure Gauge	7
19—Voltmeter	8
20—Fuel Gauge	7
21—Coolant Temperature Gauge	7
22—Door Latch	
23—Turn Signal Control	76
24—Turn Indicator Lamp	76
25—Steering Wheel Telescope Release	13
26—Steering Wheel	13
27—High-Beam Indicator	
28—Speed-Hour Meter	7
29—Speed Indicator Wheel	30
30—Lighter	
31—Horn Switch	
32—Speed Control Lever	27
33—Range Control Lever	27
34—Remote Cylinder Levers	46
35—Rockshaft Depth Stop Knob	35
36—Rockshaft Control	35
37—Hand Throttle	22
38—Rockshaft Selector Lever	36
39—Engine Stop Knob	23
40—Key Switch	17
41—Brake Pedals	24
42—Steering Wheel Tilt Release	13
43—Differential Lock Pedal	32
44—Dimmer Switch	74
45—Clutch Pedal	24
46—Light Switch	74
47—Starting Aid Switch	19
48—Air Cleaner Indicator	8
49—Transmission Oil Indicator	8
50—PTO Clutch Lever	53

Check Instruments Often

Leave key switch on while operating tractor so instruments will function. Check indicator lights each time engine is started to be sure they work.

Speed-Hour Meter

Keep engine speed between 1500 and 2200 rpm for most work. Align needle with P.T.O. mark (2200 rpm) for standard P.T.O. speed.

Turn speed indicator wheel to show correct gear, so travel speed is also indicated.

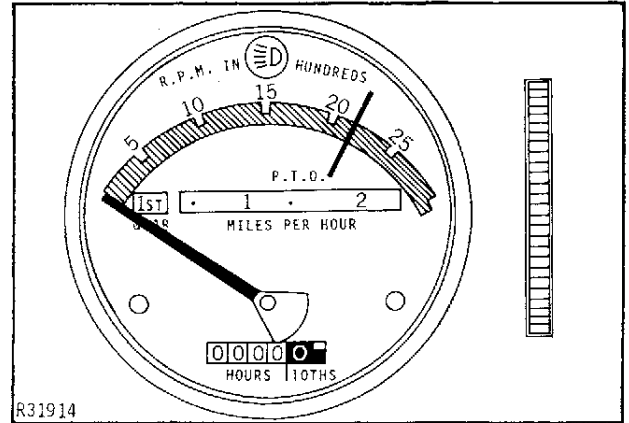

R31914

Fuel Gauge

Stop to refuel before fuel gauge reaches empty mark. Do not allow a diesel engine to run out of fuel.

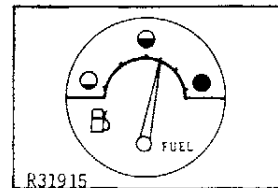

R31915

Engine Temperature Gauge

Green band represents normal operating temperature. Green and white striped area represents maximum safe temperature. If gauge reaches striped area, check grille screens and radiator for plugging. Reduce load or shift to a lower gear. If it reaches solid red area, stop tractor and determine the cause. See page 105.

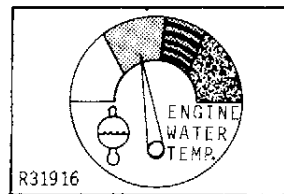

R31916

Engine Oil Pressure Gauge

If engine oil pressure gauge ever drops into the red band, stop engine immediately and determine cause. If low oil level is not the cause, see your John Deere dealer. NEVER operate an engine without sufficient oil pressure—not even for a minute.

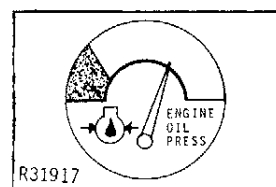

R31917

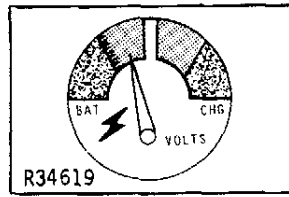

Voltmeter

With key switch on and engine stopped, voltmeter should reach left-hand green band. If it does not, batteries are undercharged. With engine running, it should rise to right-hand green band. If needle stays in either amber band, see your John Deere dealer.

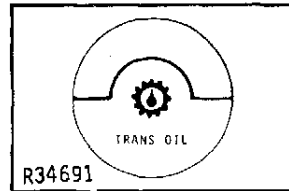

Transmission Oil Pressure Indicator

Glowing lamp indicates either high oil temperature or low oil pressure. See page 25 (Power Shift) or page 29 (QUAD-RANGE).

As a test, lamp should glow when key switch is in start position.

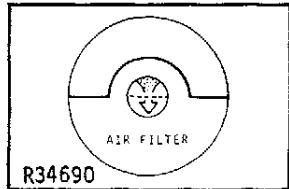

Air Filter Restriction Indicator

Indicates a restricted air filter. If lamp glows, service the air cleaner. See page 92.

As a test, lamp should glow when key switch is in start position.



Operator's Station

SOUND-GARD BODY CONTROLS

⚠ CAUTION: The SOUND-GARD Body air filters are not designed to filter out harmful chemicals. When using agricultural chemicals, follow the instructions in the implement operator's manual and those given by the chemical manufacturer.

Blower

To keep the air clean, run the blower continuously when operating the tractor. Keep doors and windows closed.

"PURGE" position provides maximum air flow.

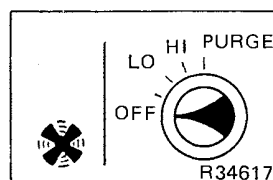

Heater

Control temperature with heater control and blower switch.

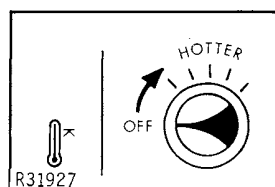

Air Conditioning

Blower switch must be turned on before the air conditioning system will operate. Regulate temperature with air conditioning control and blower speed.

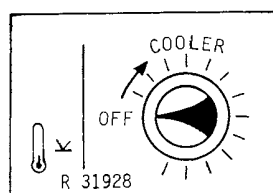

Wipers

The left-hand and right-hand windshield wipers have separate switches.

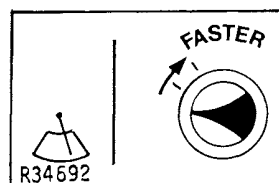

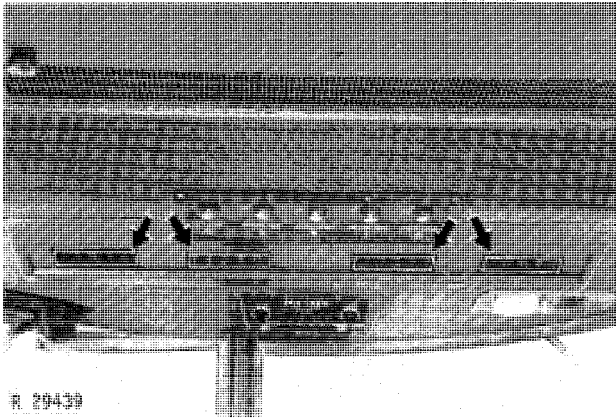

Louvered Air Outlets

Adjust louvers to direct air where needed, such as for defogging windows.

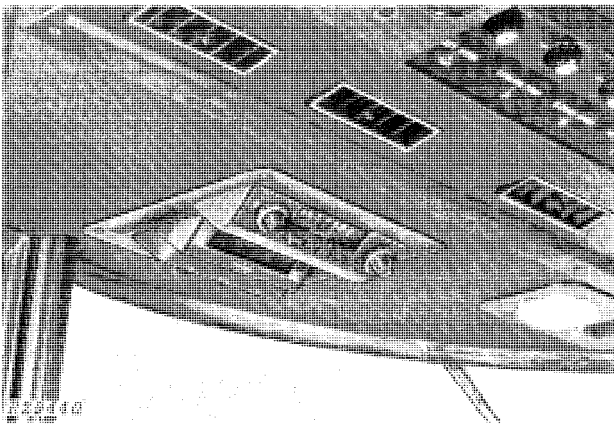

Radio (optional)

If an FM stereo signal is weak, the radio automatically switches to monaural reception.

To adjust push-button tuning, pull button out to the stop. Tune to desired station, then push button all the way in.

8-Track Tape Player (optional)

To start tape player, insert a tape cartridge label side up. To stop player, remove the cartridge.

To avoid damage to player, keep tapes free of dust.

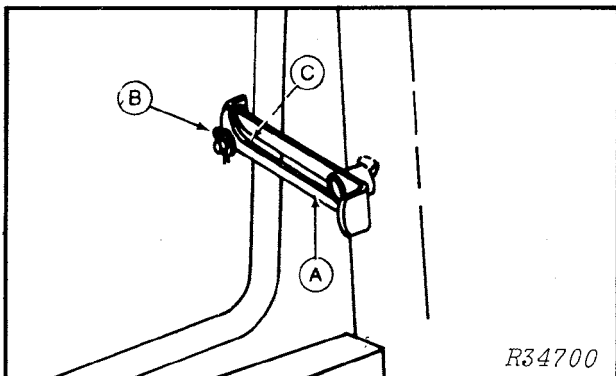

Windows

To open a window, lift and push BOTH sliding latches (A) out to the notched detents.

For an emergency exit, remove Quik-Lock Pins (B) and headed pins (C). Swing windows out as far as necessary.

SEAT BELT

 **CAUTION:** Use seat belt under almost all operating conditions.

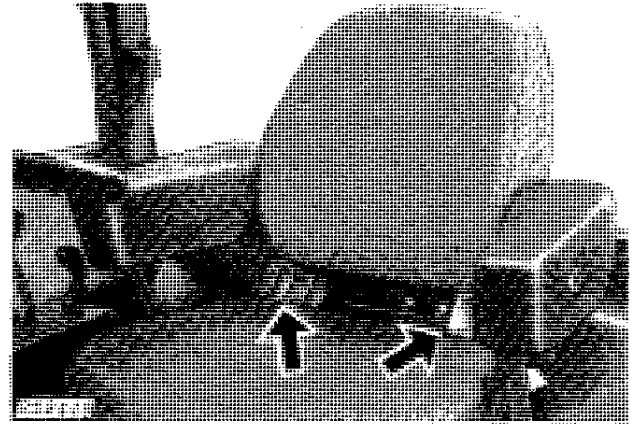

STANDARD SEAT

Height and Weight Adjustment

1. Stand and lift seat release lever. Seat will move automatically to the upper, rear position.
2. Move height adjustment lever to desired position.
3. To increase spring tension for a heavy operator, turn weight adjusting screw clockwise.

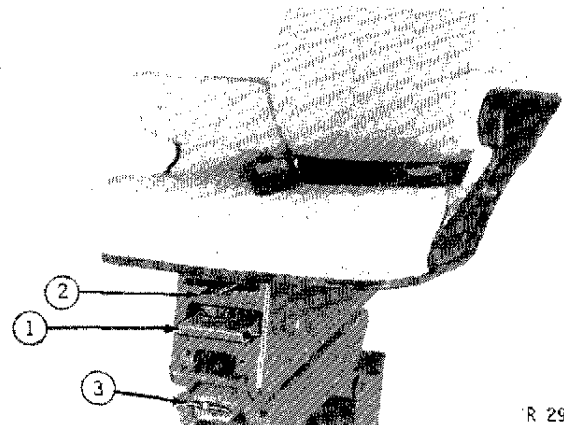

R 29442

Adjusting Counterbalance Spring

If seat does not move fully to the rear when seat release latch is lifted, tighten counterbalance spring.

1. Push seat to upper rear position.
2. Insert a screwdriver in slotted end of counterbalance shaft and press inward.
3. Turn shaft counter-clockwise two or three turns. Be sure it engages the locking slot.

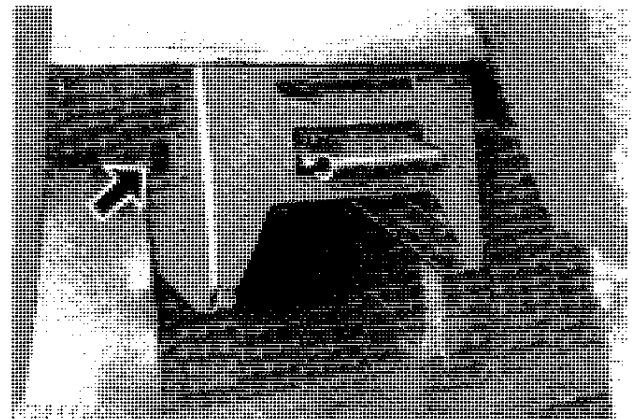

PERSONAL POSTURE™ SEAT



Clean seat frequently with a soft brush or vacuum cleaner. Use solvent-type spot remover to clean oil or grease stains.

The procedures are the same as previously described for moving seat to its upper rear position, adjusting for height of operator, and adjusting counterbalance spring.

Adjusting for Weight of Operator

1. Flip ratchet lock (A) rearward to adjust for firmer ride or forward to adjust for softer ride.
2. Repeatedly move lever (B) up and down.

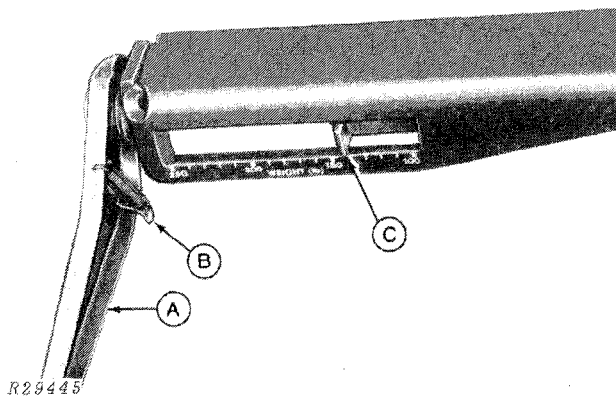

A—Ratchet Lock
B—Weight Adjustment Lever
C—Weight Indicator Scale

Adjusting Armrest Height

Press armrest release button (A) and move armrest to desired position.

Do not sit on armrest.

Adjusting Backrest Angle

To change backrest angle, raise or lower backrest control knob (N).

Adjusting Lumbar Support

For more pressure against your lower back, push lumbar support control (C) down.

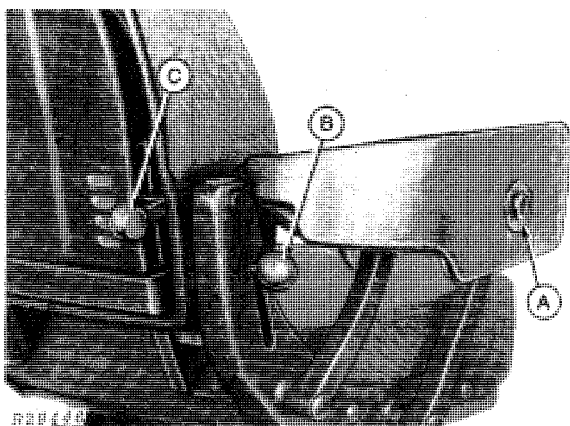

HYDRACUSHIONED™ SEAT CONTROLS (OPTIONAL)

Height Adjustment

With engine running, raise or lower lever (A). Seat will maintain same height regardless of operator weight.

Fore-And-Aft Adjustment

Push lever (B) to left and slide seat forward or back.

Ride Adjustment

Move lever (C) up for a firmer ride or down for a softer ride.

Attenuator

Seat will move forward and rearward slightly to cushion the ride. If you want to prevent this motion, hook "attenuator" lever (D) in upper right position. Motion may be undesirable when working in close quarters, such as hooking up an implement or when transporting on road.

IMPORTANT: Keep area under seat completely clear of foreign objects to avoid damaging seat mechanism.

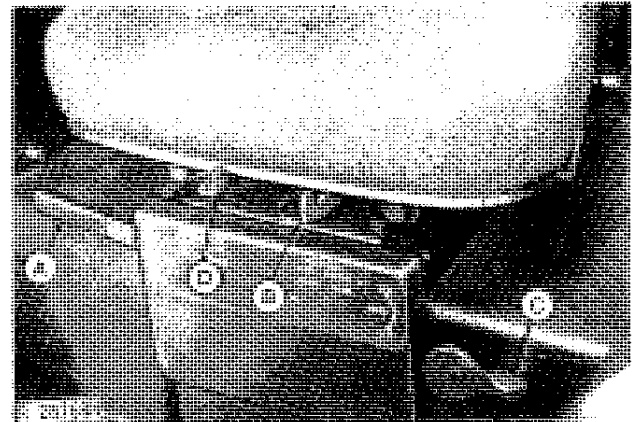

A—Height Adjustment
B—Fore-And-Aft Adjustment
C—Ride Adjustment
D—Attenuator

STEERING WHEEL

1. Lift tilt release lever and move steering column to desired angle.
2. Loosen steering wheel hub and extend or retract steering wheel as desired. Tighten hub.

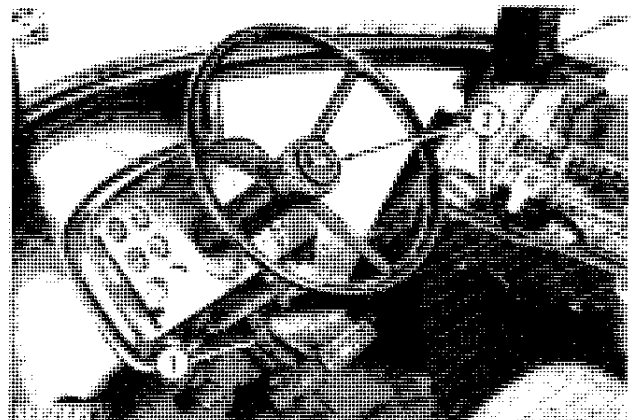



Engine Break-in

The engine is ready for normal operation. However, you should be extra cautious during the first 100 hours.

1. Avoid unnecessary engine idling. If tractor will be idle longer than five minutes, stop the engine.

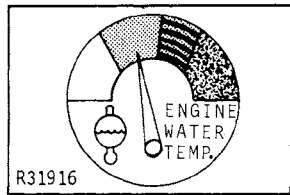

2. Watch coolant temperature gauge closely. If temperature rises to the warning zone, shift to a lower gear or reduce load. Unless temperature quickly drops, stop the engine and determine the cause.

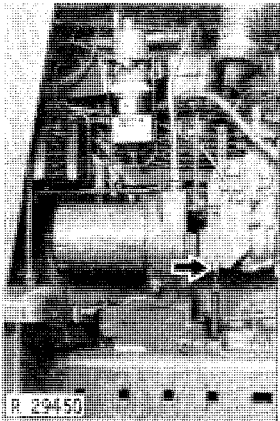

Engine Oil Dipstick

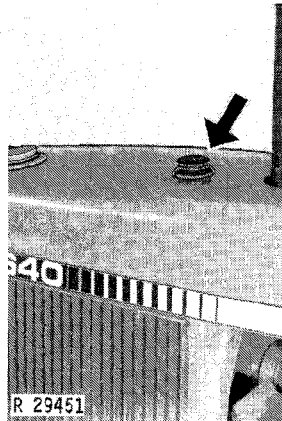

Radiator Cap

3. Check engine oil and coolant levels more frequently. Watch for any signs of leaks.

Coolant level should be 1-1/2 in. (38 mm) above the baffle located in the radiator top tank.

4. Follow break-in lubrication instructions on page 81.
5. Until you become thoroughly familiar with the sound and feel of your new tractor, stay extra attentive and alert.



Suggest:

If the above button click is invalid.

Please download this document

first, and then click the above link

to download the complete manual.

Thank you so much for reading



Prestarting Checks

Do the following before starting the engine for the first time each day.

1. Check the engine oil level. Do not operate engine when oil level is below the low mark on dipstick (A). Fill engine (B) with oil specified on page 78.

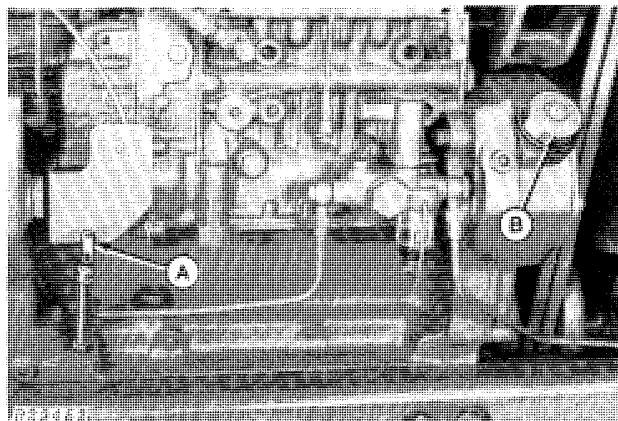

2. Check the coolant level. It should be 1-1/2 in. (38 mm) above the baffle located in the radiator top tank.

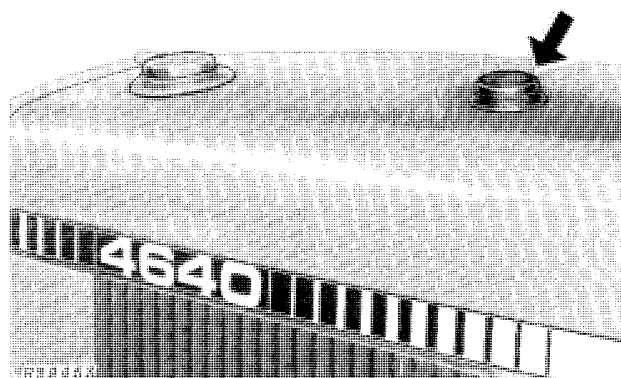

3. Check fuel filters (A) and fuel pump sediment bowl (B). If water or sediment is present, remove it. See page 102.

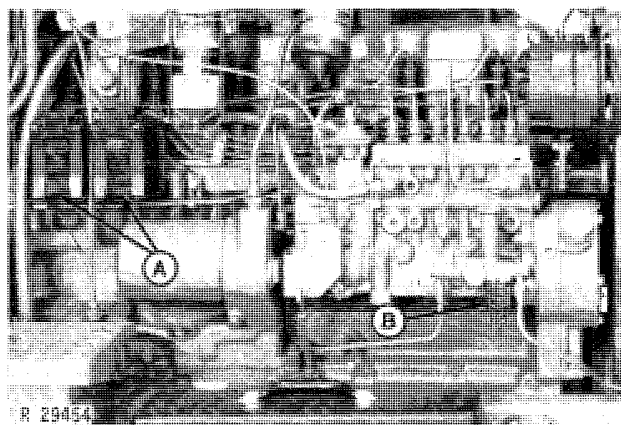

Continued on next page

<https://www.ebooklibonline.com>

Hello dear friend!

Thank you very much for reading.

Enter the link into your browser.

The full manual is available for immediate download.

<https://www.ebooklibonline.com>